

www.asitest.com
www.avionics-specialist.com

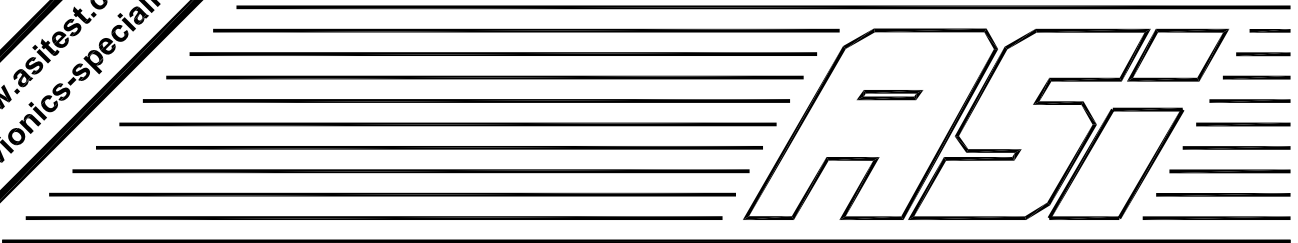

AVIONICS SPECIALIST, INC.

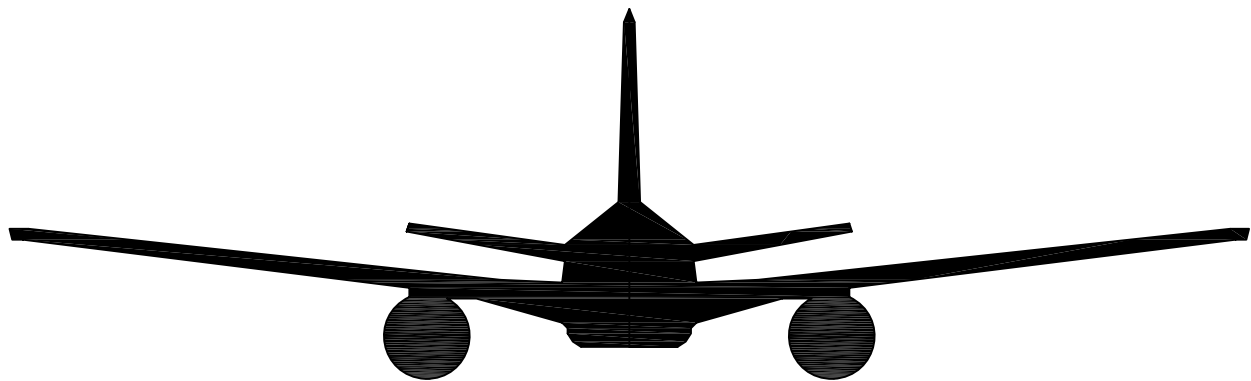

**SPECIALIZED
AVIONICS TEST EQUIPMENT
PRODUCT CATALOG**

3833 PREMIER AVE. MEMPHIS, TN 38118 USA



Specialized Avionics Test Equipment Product Catalog

ASI Test Equipment Dealers:

AERCAP / www.aercap.com

6324 Global Dr. Memphis, TN 38141 / Ph: 901-362-8600

Contact: Kris Triplett / ktriplett@aercap.com

Aero Express / www.aeroexpress.com

1813 SW Market St. Lee's Summit, MO 64082 / Ph: 816-246-4500

Contact: Mary Schmale / mary@aeroexpress.com

DAC International / www.dacint.com

15501 SW 29th St. Suite 101 Miramar, FL 33027 / Ph: 512-331-5323 / 800-527-2531

Contact: Jeremy Cielak / jcielak@dacint.com

Dallas Avionics, Inc. / www.dallasavionics.com

2525 Santa Anna Ave. Dallas, TX 75228 / Ph: 214-320-9770 / 800-527-2581

Contact: Chuck Moore / cm@dallasavionics.com

EDMO Distributors, Inc. / www.edmo.com

12830 E. Mirabeau Pkwy. Spokane, WA 99216 / Ph: 509-535-8280 / 800-235-3300

Contact: Mark Gardner / mark@edmo.com

Glendale International / www.glendale-int.co.uk

17 Totman Crescent, Rayleigh, Essex SS6-7UY UK / Ph: +44(0)1268-741770

Contact: Adam Gratton / adam@glendale-int.co.uk

Intertrade - A Collins Aerospace Co. / www.rockwellcollins.com/intertrade

400 Collins Road NE MS153-220, Cedar Rapids, IA 52498 / Ph: 319-378-3500 / 800-553-7280

Contact: Kyle Koth / kyle.koth@collins.com

Richardson Electronics, Ltd / www.rell.com

40W267 Keslinger Rd. LaFox, IL 60147 / Ph: 630-208-2200

Contact: Tara Farrell / tara@rell.com

03-01-2023

OEM TO ASI EQUIVALENT CROSS REFERENCE

EQUIV MN	EQUIV PN	EQUIV OEM	JC-AIR PN	ASI MN	DESCRIPTION
002-0518-00	696-4096-00	HONEYWELL (BENDIX/KING)		ASI-428-1	TEST PANEL FOR KPI-552/552B AND KPI-553A/553B
172H-1	522-1708-000	ROCKWELL COLLINS		ASI-329-2	DUMMY COMPOSITE ANTENNA
172H-10	522-4601-001	ROCKWELL COLLINS		ASI-329-10	ELECTRICAL DUMMY LOAD
172H-12	777-1455-001	ROCKWELL COLLINS		ASI-329-12	SHUNT DUMMY ANTENNA
172H-17	777-1864-001	ROCKWELL COLLINS		ASI-329-9	ELECTRICAL DUMMY LOAD
172H-18	622-0180-001	ROCKWELL COLLINS		ASI-207-1	DUMMY ANTENNA SHUNT
172H-18	622-0180-002	ROCKWELL COLLINS		ASI-207-1-220	DUMMY ANTENNA SHUNT (220 VAC)
172H-18A	622-7148-001	ROCKWELL COLLINS		ASI-329-3	ANTENNA SIMULATOR, SHUNT
172H-18A	622-7148-001	ROCKWELL COLLINS		ASI-329-3-220	ANTENNA SIMULATOR, SHUNT (220 VAC)
172H-21	622-1380-001	ROCKWELL COLLINS		ASI-329-7	ANTENNA SIMULATOR, 16 FT WHIP (TIED DOWN)
172H-21A	622-1732-001	ROCKWELL COLLINS		ASI-329-8	ANTENNA SIMULATOR, 16 FT WHIP (STRAIGHT UP)
172H-21A	622-1732-002	ROCKWELL COLLINS		ASI-329-8A	ANTENNA SIMULATOR, 16 FT WHIP (STRAIGHT UP)
172H-22	622-1381-001	ROCKWELL COLLINS		ASI-329-11	ANTENNA SIMULATOR, 32 FT WHIP
172H-26	622-5605-001	ROCKWELL COLLINS		ASI-329-13	TAILCAP ANTENNA SIMULATOR
172H-27	4561700-101B	ROCKWELL COLLINS		ASI-329-14	ANTENNA SIMULATOR
172H-8	522-4515-001	ROCKWELL COLLINS		ASI-329-1	ELECTRICAL DUMMY LOAD (115 VAC 400 HZ)
172H-8	522-4515-002	ROCKWELL COLLINS		ASI-329-1A	ELECTRICAL DUMMY LOAD (115 VAC 60 HZ)
172H-8A	642-2190-001	ROCKWELL COLLINS		ASI-329-1C	ELECTRICAL DUMMY LOAD (MODIFIED FOR CU-2041/AR)
200-7157-00	200-07157-0000	HONEYWELL (BENDIX/KING)		ASI-200-7157-00	ASYNCR CARD ONLY (SEE ASI-050-2605-00 FOR ASYNCR KIT WITH CABLES)
200-7164-00	200-07164-0000	HONEYWELL (BENDIX/KING)		ASI-200-7164-00	SYNCR CARD ONLY (SEE ASI-050-2606-00 FOR SYNCR KIT WITH CABLES)
438K-2	622-5731-001	ROCKWELL COLLINS		ASI-310	GRC-171/211 MAINTENANCE KIT
438K-2C	622-9663-001	ROCKWELL COLLINS		ASI-310-2C	MAINTENANCE KIT FOR RT1272D
440X-1	763-5591-001	ROCKWELL COLLINS		ASI-40X-1	CABLE: ASI-40X-10/14 (440X-10/14) TO 562A-5F
440X-10	522-4715-001	ROCKWELL COLLINS		ASI-40X-10	CABLE: ASI-191 (978F-1D) TO 331D-3, AQU-2/A
440X-11	554-2549-001	ROCKWELL COLLINS		ASI-40X-11	CABLE: 978F-11P TO 562P-1/1E1
440X-12	554-2547-002	ROCKWELL COLLINS		ASI-40X-12	CABLE: 978F-11P TO 562P-1
440X-13	522-4716-001	ROCKWELL COLLINS		ASI-40X-13	CABLE: 978F-9A TO 562P-1/1E1
440X-14	522-4717-001	ROCKWELL COLLINS		ASI-40X-14	CABLE: 978F-10R TO 562A-5F
440X-15	554-2548-001	ROCKWELL COLLINS		ASI-40X-15	CABLE: 978F-10R TO 562R-1/1E
440X-16	522-4718-001	ROCKWELL COLLINS		ASI-40X-16	CABLE: 978F-9A TO 562R-1/1E
440X-17	522-4719-001	ROCKWELL COLLINS		ASI-40X-17	CABLE: 978F-3M TO 978F-2S
440X-18	522-4720-001	ROCKWELL COLLINS		ASI-40X-18	CABLE: 978F-3M TO 614E-7C/8A
440X-19	522-4721-001	ROCKWELL COLLINS		ASI-40X-19	CABLE: 978F-3M TO 978F-2S TO 614E-8B
440X-2	554-2547-001	ROCKWELL COLLINS		ASI-40X-2	CABLE: 978F-10R TO 562R-1/1E
440X-20	522-4722-001	ROCKWELL COLLINS		ASI-40X-20	CABLE: 978F-3M TO 978F-2S TO 614E-9B
440X-21	522-4723-001	ROCKWELL COLLINS		ASI-40X-21	CABLE: 978F-3M TO 978F-2S TO 614E-9C
440X-22	522-4859-001	ROCKWELL COLLINS		ASI-40X-22	CABLE: 978F-4A TO 344C-1D
440X-23	522-4860-001	ROCKWELL COLLINS		ASI-40X-23	CABLE: 978F-3M TO 614E-7()
440X-3	522-4708-001	ROCKWELL COLLINS		ASI-40X-3	CABLE: ASI-191 (978F-1D) TO 978F-2S
440X-4	522-4709-001	ROCKWELL COLLINS		ASI-40X-4	CABLE: ASI-191 (978F-1D) TO 329B-7/329B-8
440X-5	522-4710-001	ROCKWELL COLLINS		ASI-40X-5	CABLE: ASI-191 (987F-1D) TO 479X-2
440X-6	522-4711-001	ROCKWELL COLLINS	01-0210-00	ASI-40X-6	CABLE: ASI-191 (978F-1D) TO 331A-6/331A-7
440X-7	522-4712-001	ROCKWELL COLLINS	01-0211-00	ASI-40X-7	CABLE: ASI-191 (978F-1D) TO 331A-6/331A-7
440X-8	522-4713-001	ROCKWELL COLLINS	01-0417-00	ASI-40X-8	CABLE: ASI-191 (978F-1D) TO 331A-6P/331A-6R
440X-9	522-4714-001	ROCKWELL COLLINS	01-0212-00	ASI-40X-9	CABLE: ASI-191 (978F-1D) TO 331A-6A1/331A-6K1
440Y-1	522-4606-001	ROCKWELL COLLINS	01-0347-00	ASI-40Y-1	980L-1/1A PLUG IN
440Y-11	522-4960-001	ROCKWELL COLLINS	01-0242-00	ASI-40Y-11	980L-1/1A PLUG IN
440Y-12	522-4961-001	ROCKWELL COLLINS	01-0479-00	ASI-40Y-12	980L-1/1A PLUG IN
440Y-13	522-4962-001	ROCKWELL COLLINS		ASI-40Y-13	980L-1/1A PLUG IN
440Y-14	522-4963-001	ROCKWELL COLLINS	01-0244-00	ASI-40Y-14	980L-1/1A PLUG IN
440Y-15	522-4964-001	ROCKWELL COLLINS	01-0705-00	ASI-40Y-15	980L-1/1A PLUG IN
440Y-16	777-1035-001	ROCKWELL COLLINS	01-0193-00	ASI-40Y-16	980L-1/1A PLUG IN
440Y-17	777-1036-001	ROCKWELL COLLINS	01-0456-00	ASI-40Y-17	980L-1/1A PLUG IN
440Y-19	777-1038-001	ROCKWELL COLLINS	01-0416-00	ASI-40Y-19	980L-1/1A PLUG IN
440Y-2	522-4607-001	ROCKWELL COLLINS	01-0345-00	ASI-40Y-2	980L-1/1A PLUG IN
440Y-20	777-1039-001	ROCKWELL COLLINS	01-0800-00	ASI-40Y-20	980L-1/1A PLUG IN
440Y-23	777-1042-001	ROCKWELL COLLINS	01-0801-00	ASI-40Y-23	980L-1/1A PLUG IN
440Y-24	777-1043-001	ROCKWELL COLLINS	01-0802-00	ASI-40Y-24	980L-1/1A PLUG IN
440Y-25	777-1044-001	ROCKWELL COLLINS	01-0803-00	ASI-40Y-25	980L-1/1A PLUG IN
440Y-26	777-1919-001	ROCKWELL COLLINS	01-0804-00	ASI-40Y-26	980L-1/1A PLUG IN
440Y-27	787-6073-001	ROCKWELL COLLINS	01-0245-00	ASI-40Y-27	980L-1/1A PLUG IN
440Y-29	787-6138-001	ROCKWELL COLLINS	01-0805-00	ASI-40Y-29	980L-1/1A PLUG IN
440Y-3	522-4609-001	ROCKWELL COLLINS	01-0213-00	ASI-40Y-3	980L-1/1A PLUG IN
440Y-30	787-6139-001	ROCKWELL COLLINS	01-0806-00	ASI-40Y-30	980L-1/1A PLUG IN
440Y-31	787-6140-001	ROCKWELL COLLINS	01-0282-00	ASI-40Y-31	980L-1/1A PLUG IN
440Y-33	787-6142-001	ROCKWELL COLLINS	01-0716-00	ASI-40Y-33	980L-1/1A PLUG IN
440Y-34	787-6143-001	ROCKWELL COLLINS		ASI-40Y-34	980L-1/1A PLUG IN
440Y-35	787-6144-001	ROCKWELL COLLINS	01-0292-00	ASI-40Y-35	980L-1/1A PLUG IN
440Y-36	787-6810-001	ROCKWELL COLLINS	01-0348-00	ASI-40Y-36	980L-1/1A PLUG IN
440Y-38	792-6383-001	ROCKWELL COLLINS	01-0349-00	ASI-40Y-38	980L-1/1A PLUG IN
440Y-39	792-6384-001	ROCKWELL COLLINS	01-0350-00	ASI-40Y-39	980L-1/1A PLUG IN
440Y-43	792-6889-001	ROCKWELL COLLINS	01-0807-00	ASI-40Y-43	980L-1/1A PLUG IN
440Y-5	522-4899-001	ROCKWELL COLLINS	01-0394-00	ASI-40Y-5	980L-1/1A PLUG IN
440Y-6	522-4900-001	ROCKWELL COLLINS	01-0418-00	ASI-40Y-6	980L-1/1A PLUG IN
440Y-67A	622-4086-001	ROCKWELL COLLINS		ASI-40Y-67A	980L-1A PLUG IN
440Y-68A	622-4087-001	ROCKWELL COLLINS	01-0372-00	ASI-40Y-68A	980L-1A PLUG IN
440Y-69A	622-4088-001	ROCKWELL COLLINS		ASI-40Y-69A	980L-1A PLUG IN
440Y-7	522-4944-001	ROCKWELL COLLINS	01-0281-00	ASI-40Y-7	980L-1/1A PLUG IN
440Y-76	622-6315-001	ROCKWELL COLLINS		ASI-40Y-76	980L-1A PLUG IN
440Y-8	522-4957-001	ROCKWELL COLLINS	01-0262-00	ASI-40Y-8	980L-1/1A PLUG IN
440Y-9	522-4958-001	ROCKWELL COLLINS	01-0464-00	ASI-40Y-9	980L-1/1A PLUG IN
476E-1	522-1431-004	ROCKWELL COLLINS		ASI-499-5	FLIGHT DIRECTOR COMPUTER TEST SET
476E-1A	522-2848-004	ROCKWELL COLLINS		ASI-499-6	FLIGHT DIRECTOR COMPUTER TEST SET
476E-4	522-1487-004	ROCKWELL COLLINS		ASI-499-1	HORIZONTAL SITUATION INDICATOR TEST SET
476E-4A	522-2698-004	ROCKWELL COLLINS		ASI-499-2	HORIZONTAL SITUATION INDICATOR TEST SET

OEM TO ASI EQUIVALENT CROSS REFERENCE

EQUIV MN	EQUIV PN	EQUIV OEM	JC-AIR PN	ASI MN	DESCRIPTION
476E-4B	522-3049-004	ROCKWELL COLLINS		ASI-499-3	HORIZONTAL SITUATION INDICATOR TEST SET
476E-4C	522-3547-000	ROCKWELL COLLINS		ASI-499-4	HORIZONTAL SITUATION INDICATOR TEST SET
476E-7	522-2078-000	ROCKWELL COLLINS		ASI-179	332E-4 TEST PANEL
477K-1	522-1146-004	ROCKWELL COLLINS		ASI-143-1	GYRO SIMULATOR
477K-1	522-1146-004	ROCKWELL COLLINS		ASI-143-2	GYRO SIMULATOR (19 INCH RACK VERSION)
477L-1	522-1147-004	ROCKWELL COLLINS		ASI-142-1	COMPASS SIMULATOR
477L-1	522-1147-004	ROCKWELL COLLINS	01-0326-00	ASI-142-2	COMPASS SIMULATOR (19 INCH RACK MOUNT VERSION)
477N-1	522-1149-000	ROCKWELL COLLINS	01-0156-00	ASI-276	STEERING COMPUTER TEST SET
477N-1A	522-3328-000	ROCKWELL COLLINS	01-0740-00	ASI-276A	STEERING COMPUTER TEST SET
477P-1A	522-3329-000	ROCKWELL COLLINS	01-0154-00	ASI-285	APPROACH HORIZON TEST PANEL
477Q-1	522-1151-000	ROCKWELL COLLINS		ASI-178-1	331A-3F/3G TEST PANEL (REPLACED BY ASI-178)
477Q-1A	522-3330-000	ROCKWELL COLLINS	01-0155-00	ASI-178	331A-3F/3G/6D TEST PANEL
477U-2	522-2710-000	ROCKWELL COLLINS	01-0370-00	ASI-192	ADF ANTENNA SIMULATOR
477U-3	522-4458-002	ROCKWELL COLLINS	01-0255-00	ASI-201-2	ADF SYSTEM TEST SET FOR ARN-83
477V-2	522-2711-002	ROCKWELL COLLINS		ASI-193	ADF-TEST SET
477V-3	792-6209-001	ROCKWELL COLLINS	01-0038-00	ASI-184	FAULT ISOLATION PANEL
477W-7	622-0158-001	ROCKWELL COLLINS	01-0033-00	ASI-207	TEST BENCH HARNESS (INCLUDES 678P-5, 172H-18, AND 7 CABLES)
478A-3	622-3701-001	ROCKWELL COLLINS		ASI-223	ZIFOR III VOR RADIAL STANDARD
479V-3	522-1339-001	ROCKWELL COLLINS		ASI-161	UNIVERSAL PRECISION TRACK SELECTOR
479X-2	522-0167-001	ROCKWELL COLLINS	01-0480-15	ASI-166	RESOLVER ZEROING PANEL
514M-2	622-7082-001	ROCKWELL COLLINS		ASI-226	INTERFACE PANEL
578F-1	522-1977-000	ROCKWELL COLLINS	01-0361-00	ASI-345	334C-3() SERVO TEST PANEL
678P-1	547-3914-000	ROCKWELL COLLINS		ASI-209-1	REPLACED BY ASI-209-1A / 678P-1A
678P-1A	547-3914-000	ROCKWELL COLLINS		ASI-209-1A	RADIO SET TEST HARNESS
678P-1B	777-1861-001	ROCKWELL COLLINS		ASI-209-1B	RADIO SET TEST HARNESS
678P-1C	622-4211-001	ROCKWELL COLLINS		ASI-209-1C	RADIO SET TEST HARNESS
678P-2	522-3400-005	ROCKWELL COLLINS		ASI-209-2	REPLACED BY ASI-209-2A / 678P-2A
678P-2A	522-3400-005	ROCKWELL COLLINS		ASI-209-2A	RADIO SET TEST HARNESS (6625-01-064-6671)
678P-2B	792-6229-001	ROCKWELL COLLINS		ASI-209-2B	RADIO SET TEST HARNESS (6625-00-064-1557 / AN/URM-157A)
678P-2C	522-3400-007	ROCKWELL COLLINS		ASI-209-2C	REPLACED BY ASI-209-2A / 678P-2A
678P-2D	522-3400-006	ROCKWELL COLLINS		ASI-209-2D	RADIO SET TEST HARNESS
678P-5	622-0304-001	ROCKWELL COLLINS	01-0493-00	ASI-207-2	RADIO TEST SET HARNESS
678Z-1	548-8001-005	ROCKWELL COLLINS	01-0668-00	ASI-427	FUNCTION TEST SET FOR 618T-1/2/3
699N-1	797-0299-001	ROCKWELL COLLINS		ASI-498	TEST SET
700D-2A	622-0147-001	ROCKWELL COLLINS	01-0232-16	ASI-245	DUAL THRESHOLD DETECTOR
850W		ROCKWELL COLLINS		ASI-378-9	FREQUENCY PLAN ADAPTER (FOR USE WITH ASI-CTS-841)
878L-1	522-3022-000	ROCKWELL COLLINS	01-0232-17	ASI-346-1	AMP TEST PANEL
878L-13	522-3971-001	ROCKWELL COLLINS		ASI-367-1	RELAY CONTROL MODULE TEST PANEL
878L-15	522-4252-001	ROCKWELL COLLINS	01-0266-00	ASI-328-1	ANTENNA COUPLER TEST PANEL
878L-16	522-4253-001	ROCKWELL COLLINS		ASI-328-2	ELECTRONIC CONTROL AMPLIFIER TEST PANEL
878L-17	522-4254-001	ROCKWELL COLLINS	01-0266-01	ASI-328-3	SIDCRIMINATOR TEST PANEL
878L-18	522-4409-001	ROCKWELL COLLINS	01-0494-00	ASI-367-2	SERVO AMPLIFIER MODULE TEST PANEL
878L-19	522-4410-001	ROCKWELL COLLINS		ASI-367-3	DISCRIMINATOR MODULE TEST PANEL
878L-19A	772-5291-001	ROCKWELL COLLINS		ASI-339-1	DISCRIMINATOR TEST PANEL
878L-19D	622-0226-001	ROCKWELL COLLINS	01-0495-00	ASI-208-1	DISCRIMINATOR TEST SET
878L-2	522-3271-000	ROCKWELL COLLINS		ASI-346-2	SERVO TEST PANEL
878L-28	777-1856-001	ROCKWELL COLLINS	01-0513-00	ASI-339-2	ELECTRONIC CONTROL AMPLIFIER TEST PANEL
878L-29	777-1857-001	ROCKWELL COLLINS	01-0447-00	ASI-339-3	COUPLER CONTROL TEST PANEL
878L-3	522-3272-000	ROCKWELL COLLINS	01-0514-00	ASI-346-3	DISCRIMINATOR TEST PANEL
878L-30	777-1858-001	ROCKWELL COLLINS	70-0663-00	ASI-339-4	COUPLER CIRCUIT CARD TEST PANEL
878L-39	622-0227-001	ROCKWELL COLLINS		ASI-208-3	SERVO-POWER SUPPLY TEST SET
878L-40	622-0228-001	ROCKWELL COLLINS	70-9024-00	ASI-208-4	TUNER-CHASSIS TEST SET
878L-41	622-0229-001	ROCKWELL COLLINS		ASI-208-5	LOGIC CARD TEST SET
890K-1	763-3346-001	ROCKWELL COLLINS		ASI-340-2	ACCESSORY KIT
890K-2	772-5480-001	ROCKWELL COLLINS		ASI-340-3	ACCESSORY KIT
92AF-1	01-0216-00	HONEYWELL (BENDIX/KING)		ASI-810-1	SERIES III ADF TEST PANEL FOR DFS-43 SYSTEM
92CN-1	01-0217-00	HONEYWELL (BENDIX/KING)		ASI-810-2	SERIES III VHF/NAV TEST PANEL FOR VCS-40 / VNS-41 SYSTEMS
92N-2	01-0215-00	HONEYWELL (BENDIX/KING)		ASI-810	SERIES III DME SYSTEM (INCLUDES ASI-810-1, ASI-810-2, AND ASI-810-3)
92XD-1	01-0218-00	HONEYWELL (BENDIX/KING)		ASI-810-3	SERIES III DME/XPDR TEST PANEL FOR DMS-44 / TRS-42 SYSTEMS
960M-1	622-0471-001	ROCKWELL COLLINS		ASI-212-1	TORQUE TESTER FOR 334C-6 / SVO-80
960M-2	622-2094-001	ROCKWELL COLLINS		ASI-212-2	TORQUE TESTER FOR 334C-9/9A, 334D-6
960M-3	622-2741-001	ROCKWELL COLLINS		ASI-212-3	TORQUE TESTER FOR 334C-9/9A/11/12H, 334D-6()
960M-4	622-5434-001	ROCKWELL COLLINS		ASI-212-4	TORQUE TESTER FOR SVO-85(), SVO-1000()
960M-5	622-6454-001	ROCKWELL COLLINS		ASI-212-5	TORQUE TESTER FOR SVO-65, SVO-75, SVT-1000A/B
964B-1	622-8665-001	ROCKWELL COLLINS		ASI-603-1	DUAL SYSTEM RS232 TEST ADAPTER
964B-2	822-0735-001	ROCKWELL COLLINS		ASI-603-2	1553/RS232 TEST ADAPTER
964B-3	822-1408-001	ROCKWELL COLLINS		ASI-603-3	RS422 TEST ADAPTER
964R-2	822-0742-001	ROCKWELL COLLINS		ASI-324	1553 ADDRESS BOX
964R-3	639-3488-001	ROCKWELL COLLINS		ASI-324-1	1553 ADDRESS BOX FOR VHF-186
966B-1	622-5479-001	ROCKWELL COLLINS		ASI-302	ARC-182 AMPLIFIER-POWER SUPPLY TEST SET
966B-2	622-5480-001	ROCKWELL COLLINS		ASI-303	ARC-182 RECEIVER TEST SET
966B-3	622-5481-001	ROCKWELL COLLINS		ASI-304	ARC-182 SYNTHESIZER TEST SET
966B-4	622-5482-001	ROCKWELL COLLINS		ASI-305	ARC-182 CONTROL PROCESSOR TEST SET
966B-6	622-5484-001	ROCKWELL COLLINS		ASI-306	ARC-182 RADIO SET CONTROL TEST SET
966B-7	622-5485-001	ROCKWELL COLLINS		ASI-307	ARC-182 RADIO SET CONTROL (HALF SIZE) TEST SET
966D-17A	622-9069-001	ROCKWELL COLLINS		ASI-601-1	FAULT MONITOR TEST SET
966D-18	622-7340-001	ROCKWELL COLLINS		ASI-602-1	SELSCAN INTERFACE TEST PANEL
966D-18	622-7340-002	ROCKWELL COLLINS		ASI-602-2	SELSCAN INTERFACE TEST PANEL
966D-18	622-7340-003	ROCKWELL COLLINS		ASI-602-3	SELSCAN INTERFACE TEST PANEL
966D-5	622-5635-001	ROCKWELL COLLINS		ASI-323-1	RADIO TEST SET
966D-5A	622-7574-001	ROCKWELL COLLINS		ASI-323-2	RADIO TEST SET
966D-5B	622-9034-001	ROCKWELL COLLINS	01-0337-00	ASI-323-3	RADIO TEST SET
966Y-2	622-6926-001	ROCKWELL COLLINS		ASI-376-1	VOR/ILS TEST PANEL
966Y-2	622-6926-002	ROCKWELL COLLINS		ASI-376-2	VOR/ILS TEST PANEL (WITH 1553 ADAPTER)
966Y-2	622-6926-003	ROCKWELL COLLINS		ASI-376-4	VOR/ILS TEST PANEL (WITH 1553 ADAPTER AND AMX ADAPTER)

OEM TO ASI EQUIVALENT CROSS REFERENCE

EQUIV MN	EQUIV PN	EQUIV OEM	JC-AIR PN	ASI MN	DESCRIPTION
966Y-2A	622-8325-001	ROCKWELL COLLINS		ASI-376-3	NAVIGATION RECEIVER TEST PANEL (WITH AM-X ADAPTER)
967M-1	622-5285-001	ROCKWELL COLLINS		ASI-497-1	HARMONIC FILTER FOR 548S-()
967M-2	622-5286-001	ROCKWELL COLLINS		ASI-497-2	AMPLIFIER TEST SET FOR 548S-()
967M-3	622-5287-001	ROCKWELL COLLINS		ASI-497-3	POWER AMPLIFIER TEST SET FOR 548S-()
967M-4	622-5288-001	ROCKWELL COLLINS		ASI-497-4	CONTROL CIRCUIT CARD TEST SET FOR 548S-() / AN/ARM-196
967M-5	622-5289-001	ROCKWELL COLLINS		ASI-497-5	PRE-REGULATOR TEST SET FOR 548S-() / AN/ARM-197
967N-1	622-5379-001	ROCKWELL COLLINS		ASI-430	ANTENNA COUPLER TEST SET
967R-2	822-1176-001	ROCKWELL COLLINS		ASI-207-4	CPL-920D CONTROL CARD TEST SET
968A-1	622-3962-001	ROCKWELL COLLINS	01-0202-00	ASI-288	FLIGHT MODE CONTROL TEST SET
968J-1	622-4369-001	ROCKWELL COLLINS		ASI-291	AUDIO CONTROL TEST SET (FOR CPN 622-4149-001)
968W-1	622-4725-001	ROCKWELL COLLINS		ASI-292	DME-40 TEST PANEL
968X-1	622-4726-001	ROCKWELL COLLINS		ASI-293	639U-1 TEST PANEL
968Y-1	622-4768-001	ROCKWELL COLLINS		ASI-221-1	51R/51RV NAVE RECEIVERARINC 547 VOR/ILS TEST SET
969L-1	635-7420-001	ROCKWELL COLLINS		ASI-405	914G-8/9/11 TEST PANEL
969N-1A	622-5532-001	ROCKWELL COLLINS		ASI-321A	GRC-171/211 AUDIO TEST FIXTURE
969N-1B	622-5655-001	ROCKWELL COLLINS		ASI-321B	GRC-171/211 AUDIO TEST FIXTURE
969N-1D	622-8014-001	ROCKWELL COLLINS		ASI-321D	AUDIO TEST FIXTURE (ALT MN: TS-4415/GRM)
969T-1	622-3868-001	ROCKWELL COLLINS		ASI-290	GPWS TEST SET
969W-1	622-3874-001	ROCKWELL COLLINS		ASI-278	ADF ANTENNA TESTER
969Y-1	622-5359-001	ROCKWELL COLLINS		ASI-358	HSI TEST PANEL FOR COLLINS 331D-7
970D-1A	622-5811-001	ROCKWELL COLLINS	01-0429-00	ASI-415-1	AIR DATA TEST PANEL WITH 6 EXTENDER CABLES
970D-1A	622-5811-002	ROCKWELL COLLINS	01-0583-00	ASI-415-2	AIR DATA TEST PANEL WITHOUT EXTENDER CABLES
970D-2	622-3304-001	ROCKWELL COLLINS		ASI-294-1	AIR DATA ELECTRONIC TEST SET
970D-2A	622-8624-001	ROCKWELL COLLINS		ASI-294-2	AIR DATA ELECTRONIC TEST SET
970D-3	622-5817-001	ROCKWELL COLLINS		ASI-415-3	VERTICAL NAV TEST SET
970E-1	622-2914-001	ROCKWELL COLLINS		ASI-187	RMI TEST PANEL
970G-1	622-2854-001	ROCKWELL COLLINS		ASI-185	ADF-60 TEST SET
970G-2	622-7345-001	ROCKWELL COLLINS		ASI-375-1	ADF TEST PANEL
970G-2	622-7345-002	ROCKWELL COLLINS		ASI-375-2	ADF TEST PANEL (WITH 1553 BUS ADAPTER)
970T-1A	622-5672-001	ROCKWELL COLLINS		ASI-315	GRC-171/211 A7 FILTER TEST SET
970T-2	622-1796-001	ROCKWELL COLLINS		ASI-316	GRC-171/211 D/A SERVO MODULE TEST SET
970T-2A	622-5673-001	ROCKWELL COLLINS		ASI-316A	GRC-171/211 D/A SERVO MODULE TEST SET
970T-3	622-1797-001	ROCKWELL COLLINS		ASI-317	GRC-171/211 SYNTHESIZER TEST SET
970T-3A	622-5674-001	ROCKWELL COLLINS		ASI-317A	GRC-171/211 SYNTHESIZER TEST SET
970T-3B	622-6396-001	ROCKWELL COLLINS		ASI-317B	GRC-171/211 SYNTHESIZER TEST SET
970T-3C	622-7201-001	ROCKWELL COLLINS		ASI-317C	GRC-171/211 SYNTHESIZER TEST SET
970T-4B	622-6871-001	ROCKWELL COLLINS	01-0584-00	ASI-318B	GRC-171/211 A3 RF RECEIVER TEST SET
970T-5	622-1799-001	ROCKWELL COLLINS	01-0243-00	ASI-319	GRC-171/211 AUDIO MODULE TEST SET
970T-5A	622-5676-001	ROCKWELL COLLINS	01-0243-00	ASI-319A	GRC-171/211 AUDIO MODULE TEST SET
970T-8	622-1812-001	ROCKWELL COLLINS	01-0672-00	ASI-320	GRC-171/211 DC-DC CONVERTER TEST SET
970V-1	622-3029-001	ROCKWELL COLLINS		ASI-790	TEST SET FOR DF-301E
970W-1	622-3099-001	ROCKWELL COLLINS		ASI-61W	ADF ANTENNA SIMULATOR (CONTROL HEAD CASE) / REPLACES ASI-186
971F-1	622-2013-001	ROCKWELL COLLINS		ASI-183-1	AUTO PILOT TEST SET (12 CABLES INCLUDED)
971F-1	622-2013-002	ROCKWELL COLLINS	01-0097-00	ASI-183-2	AUTO PILOT TEST SET(CABLES NOT INCLUDED)
971K-1	622-2011-001	ROCKWELL COLLINS	01-0098-00	ASI-295	AREA NAVIGATION SYSTEM TEST PANEL
971T-1	622-2640-001	ROCKWELL COLLINS	01-0099-00	ASI-296-1	FLIGHT PROFILE COMPARATOR TEST PANEL
971T-1	622-2640-002	ROCKWELL COLLINS		ASI-296-2	FLIGHT PROFILE COMPARATOR TEST PANEL
972S-1	622-1626-001	ROCKWELL COLLINS		ASI-204	AUTOPILOT RAMP TEST SET FOR AP-106/107
972S-2	622-1628-001	ROCKWELL COLLINS	01-0523-00	ASI-205	AUTOPILOT BENCH TEST SET FOR AP-106/107
972S-3	622-2562-001	ROCKWELL COLLINS		ASI-206	SERVO TEST SET FOR AP-106/107
972S-4	622-3211-001	ROCKWELL COLLINS		ASI-431	SERVO TEST SET FOR 334C-12H / SVO-830
972S-5	622-7122-001	ROCKWELL COLLINS		ASI-403-1	SVO SERVO TEST PANEL FOR SVO-75/85
972S-5	622-7122-002	ROCKWELL COLLINS		ASI-403-2	SVO SERVO TEST PANEL FOR SVO-1000
973K-1	622-0377-001	ROCKWELL COLLINS	01-0105-00	ASI-208-6	ANTENNA COUPLER GROUP TEST SET (INCL ASI-208-1, -2, -3, -4)
973W-10	822-1512-001	ROCKWELL COLLINS		ASI-301-10	ARC-210 RADIO TEST SET
973W-2	622-5058-001	ROCKWELL COLLINS	01-0197-00	ASI-300	ARC-182 R/T TEST SET
973W-3	622-6121-001	ROCKWELL COLLINS	01-0200-00	ASI-301	ARC-182 RADIO TEST SET
974G-1	797-0097-001	ROCKWELL COLLINS		ASI-231-1	RADIO ALTIMETER INDICATOR TEST PANEL FOR 339H-1()
975D-1	787-6842-001	ROCKWELL COLLINS	01-0432-00	ASI-181	DME TEST PANEL
975D-2	622-3582-001	ROCKWELL COLLINS	01-0422-00	ASI-182	DME TEST SET
977A-1	777-1356-001	ROCKWELL COLLINS		ASI-327-1	TEST PANEL
977B-1	777-1357-001	ROCKWELL COLLINS		ASI-327-2	TEST PANEL
977C-1	777-1358-001	ROCKWELL COLLINS	01-0293-00	ASI-327-3	TEST PANEL
977D-1	777-1359-001	ROCKWELL COLLINS		ASI-327-4	TEST PANEL
978F-10R	522-4086-001	ROCKWELL COLLINS		ASI-377-4	STEERING COMPUTER TEST ADAPTER FOR FD-109
978F-11P	522-4113-001	ROCKWELL COLLINS		ASI-377-6	STEERING COMPUTER TEST ADAPTER FOR FD-109
978F-1D	522-3424-000	ROCKWELL COLLINS		ASI-191	INSTRUMENT TEST SET
978F-2S	522-3498-000	ROCKWELL COLLINS		ASI-167	SYNCHRO SIMULATOR
978F-3M	522-3423-000	ROCKWELL COLLINS		ASI-377-7	MODE CONTROL TEST PANEL FOR 614E-()
978F-4A	522-3427-001	ROCKWELL COLLINS	01-0232-00	ASI-377-1	AMPLIFIER TEST PANEL FOR FD-108/109
978F-5R	522-3501-000	ROCKWELL COLLINS	01-0496-00	ASI-377-3	STEERING COMPUTER TEST PANEL FOR FD-109
978F-6P	522-3426-000	ROCKWELL COLLINS	01-0231-00	ASI-377-5	STEERING COMPUTER TEST PANEL FOR FD-109
978F-8W	522-3701-001	ROCKWELL COLLINS		ASI-377-8	COMPARATOR WARNING MONITOR TEST PANEL
978F-9A	522-4085-001	ROCKWELL COLLINS		ASI-377-2	AMPLIFIER TEST ADAPTER PANEL FOR FD-108/109
980H-1	522-4380-001	ROCKWELL COLLINS	01-0929-00	ASI-328	ANTENNA COUPLER TEST SET
980H-2	522-4541-001	ROCKWELL COLLINS		ASI-340-1	ANTENNA TESTER / SIMULATOR
980H-3	522-4748-001	ROCKWELL COLLINS	01-0384-00	ASI-346	ANTENNA COUPLER TEST SET
980H-5	777-1526-001	ROCKWELL COLLINS		ASI-208	ANTENNA COUPLER TEST SET
980H-6	777-1534-001	ROCKWELL COLLINS		ASI-339	ANTENNA COUPLER TEST SET
980L-1A	622-0846-001	ROCKWELL COLLINS	01-0455-00	ASI-282	UNIVERSAL FLIGHT CONTROL TEST SET
980N-1	522-4610-004	ROCKWELL COLLINS		ASI-203	RADIO ALTIMETER TEST SET
997T-1	822-0030-001	ROCKWELL COLLINS		ASI-246-3	SERVO MOUNT TEST ADAPTER
999U-1	622-3635-001	ROCKWELL COLLINS		ASI-205-6	TEST SET ADAPTER
A3286382		US ARMY		ASI-A3286382	CABLE: W259 INC TO AN/VSQ-2B#1 TO CISCO 2924MXL
AA3710-1		MARCONI		ASI-AA3710-1	OVERALL TEST RIG FOR AD370 SYSTEM (REPLACED BY ASI-AA3710-2)

OEM TO ASI EQUIVALENT CROSS REFERENCE

EQUIV MN	EQUIV PN	EQUIV OEM	JC-AIR PN	ASI MN	DESCRIPTION
AA3710-2		MARCONI		ASI-AA3710-2	OVERALL TEST RIG FOR AD370 SYSTEM (INCLUDES 5 CABLES)
ACI-100	7016068-901	HONEYWELL		ASI-266-3	ACCESS INTERFACE FOR PRIMUS-700/701
ACS-5A	253E0414-00	L3		ASI-ACS-5A	AIRCRAFT SIMULATOR SYSTEM (MUST BE PURCHASED FROM GLENDALE)
ADS-100	7015457-901	HONEYWELL		ASI-263-3	AIR DATA SIMULATOR
ADT-34AF	3614307-3401	HONEYWELL (BENDIX)		ASI-420-2	RNA-34AF ADAPTER PANEL
AIT-4A	8074503-0401	HONEYWELL (BENDIX)		ASI-743	TCAS PPT TEST PANEL ADAPTER
ALT-51A	2037120-0501	HONEYWELL (BENDIX)		ASI-199	ALA-51A/INA-51A TEST PANEL
ALT-52A	2041475-5201	HONEYWELL (BENDIX)		ASI-802	RADIO ALTIMETER TEST PANEL
AMT-51A	2037028-5103	HONEYWELL (BENDIX)		ASI-175	ALA-51A RAMP TEST SET
AMT-52A	2041595-5201	HONEYWELL (BENDIX)		ASI-175-2	PORTABLE ALTIMETER TEST SET
AN/ARM-102	522-4545-001	ROCKWELL COLLINS		ASI-789	TEST SET, ARA-50
AN/ARM-93	522-4458-001	ROCKWELL COLLINS		ASI-201-1	ADF SYSTEM TEST SET FOR ARN-83
ANT-1FBM	8056275-0501	HONEYWELL (BENDIX)		ASI-153-4	SECTOR SCAN ANTENNA TEST ADAPTER
ARM-165	623-5403-001	ROCKWELL COLLINS		ASI-308-1	RADIO TEST SET
ARM-165A	622-2750-001	ROCKWELL COLLINS		ASI-308-2	RADIO TEST SET
AST-4A	2041886-0401	HONEYWELL (BENDIX)		ASI-770	RADAR ANTENNA SIMULATOR PANEL
ATT-1F	2038070-0501	HONEYWELL (BENDIX)	01-0388-00	ASI-153-1	BENDIX ANT-1T TEST PANEL
ATT-1FB	2038270-0502	HONEYWELL (BENDIX)		ASI-153-2	BENDIX ANT-1TB TEST PANEL
ATT-1FB	2038270-0503	HONEYWELL (BENDIX)		ASI-153-3	BENDIX ANT-1TB TEST PANEL WITH SECTOR SCAN TEST ADAPTER
ATT-4A	2041592-0401	HONEYWELL (BENDIX)		ASI-771	RADAR ANTENNA TEST PANEL
AVR-02	100-2120-200	L3		ASI-AVR-02	COCKPIT VOICE RECORDER TEST PANEL (INCLUDES 2 CABLES)
AXT-4A	8055692-0401	HONEYWELL (BENDIX)		ASI-799	FAULT DATA TEST UNIT
BD83-101		LOCKHEED		ASI-BD83-101	HYDRAULIC PUMP TEST ADAPTER SET
BTCG-03		CERBERUS GUINARD		ASI-1026	SMOKE DETECTION CONTROL UNIT TEST SET FOR CERBERUS RCGSK-10-0X
BTR-9466		ROSEMOUNT AEROSPACE		ASI-1020-3	POINT LEVEL SENSOR FIXTURE FOR 1742F3/5/6/8/S417T108-7/-11/-14/-16
CBM-100	7012364-902	HONEYWELL		ASI-265	BUS MONITOR
COT-1FB	2041348-0101	HONEYWELL (BENDIX)		ASI-252-1	RADAR CONTROL TEST PANEL
COT-4A	2041593-0401	HONEYWELL (BENDIX)	01-0660-01	ASI-252-2	RADAR CONTROL TEST PANEL
CPT-83A	2041065-8301	HONEYWELL (BENDIX)		ASI-422	GROUND PROXIMITY WARNING SYSTEM TEST PANEL
CSS-10	622-5330-001	ROCKWELL COLLINS		ASI-165	SYNCHRO SOURCE
CT21038		HONEYWELL (GARRETT)		ASI-1014	737 EDPS SPCU TEST PANEL
CT24128		HONEYWELL (GARRETT)		ASI-1014-1	126 OHM LOAD FOR ASI-1014
CT2506		HONEYWELL (GARRETT)		ASI-1005	PRESSURE SENSOR PNEUMATIC TEST PANEL
CT2542		HONEYWELL (GARRETT)	01-0232-15	ASI-287	PNEUMATIC SYSTEM CONTROLLER TEST PANEL
CT3124		HONEYWELL (GARRETT)		ASI-28-7A	CABLE: ASI-287 (CT2542) TO 627248
CT3258		HONEYWELL (GARRETT)	01-0253-00	ASI-10-27F	EXTENDER CARD: 624066-X A1
CT3259		HONEYWELL (GARRETT)	01-0253-00	ASI-10-27G	EXTENDER CARD: 624066-X A2-A3
CT3260		HONEYWELL (GARRETT)		ASI-10-27H	EXTENDER CARD: 624066-X A4
CT8007		HONEYWELL (GARRETT)		ASI-28-7C	S1 SHAFT EXTENDER
CT8008		HONEYWELL (GARRETT)		ASI-28-7B	EXTENDER CARD: 36 POS
CT8044		HONEYWELL (GARRETT)	01-0253-00	ASI-1027-3	TEST FIXTURE
CT8046		HONEYWELL (GARRETT)	01-0253-00	ASI-10-27C	CABLE: ASI-1027-1 (CT8069) DC POWER
CT8058		HONEYWELL (GARRETT)		ASI-10-27E	CABLE: TEST LEAD
CT8069		HONEYWELL (GARRETT)		ASI-1027-1	WINDOW HEAT CONTROL TEST PANEL FOR HONEYWELL 624066-X
CT8070		HONEYWELL (GARRETT)		ASI-10-27A	CABLE: ASI-1027-1 (CT8069) AC POWER
CT8071		HONEYWELL (GARRETT)		ASI-10-27B	CABLE: ASI-1027-1 (CT8069) TO ASI-1027-2 (CT8073)
CT8072		HONEYWELL (GARRETT)		ASI-10-27D	CABLE: ASI-1027-1 (CT8069) TO UUT (624066-X)
CT8073		HONEYWELL (GARRETT)		ASI-1027-2	SIMULATED LOAD
CT8122		HONEYWELL (GARRETT)		ASI-1004	PRESSURE SENSOR ELECTRONIC TEST PANEL
CTC-429	822-0854-001	ROCKWELL COLLINS		ASI-CTC-429	PRO LINE TEST CARD (SOFTWARE MUST BE PURCHASED FROM COLLINS)
CTS-10	622-4561-001	ROCKWELL COLLINS	01-0482-00	ASI-CTS-10	UNIVERSAL ATR BREAKOUT BOX
CTS-11	622-5380-001	ROCKWELL COLLINS		ASI-CTS-11	ADI-85 INSTRUMENT TEST SET
CTS-11A	622-6823-001	ROCKWELL COLLINS		ASI-CTS-11A	COLLINS ADI-77 INSTRUMENT TEST SET
CTS-12	622-5381-001	ROCKWELL COLLINS		ASI-CTS-12	COLLINS HSI-85 INSTRUMENT TEST SET
CTS-200	622-4281-001	ROCKWELL COLLINS	01-0433-00	ASI-338-1	HF TEST INTERCONNECT TEST PANEL
CTS-201	622-4282-001	ROCKWELL COLLINS	01-0363-00	ASI-338-2	HF ANTENNA SIMULATOR
CTS-202	622-4283-001	ROCKWELL COLLINS	01-0505-00	ASI-338-3	HF TEST PANEL
CTS-203	622-4285-001	ROCKWELL COLLINS	01-0515-00	ASI-338-4	HF TEST PANEL
CTS-204	622-5403-001	ROCKWELL COLLINS	01-0465-00	ASI-338-5	HF TEST PANEL
CTS-231	622-5188-001	ROCKWELL COLLINS		ASI-289-1	OUTPUT MON TEST SET (CTL-X0 MAN FIG 5-3 - 5-6)
CTS-232	622-5189-001	ROCKWELL COLLINS		ASI-289-2	MONITOR/NCS SIMULATOR TEST SET
CTS-300	622-4946-001	ROCKWELL COLLINS		ASI-297	GENERATOR TEST PANEL
CTS-301	622-5225-001	ROCKWELL COLLINS	01-0430-00	ASI-298	RADAR NAV TEST PANEL
CTS-351	622-3883-001	ROCKWELL COLLINS		ASI-257-2	S-TEC ANS-351 TEST SET
CTS-451	622-3882-001	ROCKWELL COLLINS	01-0430-00	ASI-257	DME-451 TEST SET
CTS-61	622-6317-001	ROCKWELL COLLINS		ASI-381	AIR DATA SENSOR TEST SET
CTS-64	622-6459-001	ROCKWELL COLLINS		ASI-412	GYRO SYSTEM TEST PANEL
CTS-82	622-4562-001	ROCKWELL COLLINS		ASI-286-1	AUTOPILOT TEST SET WITH CABLES
CTS-82	622-4562-002	ROCKWELL COLLINS		ASI-286-2	AUTOPILOT TEST SET WITHOUT CABLES
CTS-840	822-0080-001	ROCKWELL COLLINS		ASI-CTS-840	RTA-84X/85X RADAR ABSORPTION BARREL
CTS-841	822-0081-001	ROCKWELL COLLINS		ASI-CTS-841	RTA-84X/85X RECEIVER/TRANSMITTER/ANTENNA TEST PANEL
CTS-851	622-4708-001	ROCKWELL COLLINS		ASI-CTS-851	APS-841H HELICOPTER AUTOPILOT TEST SET
CTS-855	622-6457-011	ROCKWELL COLLINS	01-0252-00	ASI-417-1	ELECTRONIC FLIGHT DISPLAY SYSTEM TEST SET WITH 3 CABLES
CTS-855	622-6457-012	ROCKWELL COLLINS		ASI-417-2	ELECTRONIC FLIGHT DISPLAY SYSTEM TEST SET WITHOUT CABLES
CTS-858	622-7321-001	ROCKWELL COLLINS	01-0553-00	ASI-418	EPD/MFD GAIN POSITION CALIBRATOR TEST SET
CTS-859	622-7975-001	ROCKWELL COLLINS		ASI-CTS-859	DIGITAL EFIS TEST PANEL
CTS-9	622-6720-001	ROCKWELL COLLINS	01-0254-00	ASI-CTS-9	EXTENDER BREAKOUT BOX
CTS-90	622-6787-001	ROCKWELL COLLINS	01-0368-01	ASI-6787-001	INTERCONNECT CABLE SET FOR VCN-186 / C-11029()
CTS-940	628-8750-001	ROCKWELL COLLINS		ASI-CTS-940	TDR-94/94D MODE S TRANSPONDER TEST SET
DA-173/GRM-10	522-1247-002	ROCKWELL COLLINS		ASI-329-6	ANTENNA SIMULATOR LOAD
DA-174/GRM-10	522-1248-004	ROCKWELL COLLINS		ASI-329-4	ANTENNA SIMULATOR LOAD
DA-175/GRM-10	522-1249-004	ROCKWELL COLLINS		ASI-329-5	ANTENNA SIMULATOR LOAD
DA-487/U	522-4514-002	ROCKWELL COLLINS		ASI-329-1B	ANTENNA SIMULATOR, LONG WIRE (SAME AS 172H-8)
DFT-73AA	2064943-0501	HONEYWELL (BENDIX)	01-0434-00	ASI-202	ADF SYSTEM TEST SET
DFT-73C1	2070555-0501	HONEYWELL (BENDIX)		ASI-202-2	ADF SYSTEM TEST SET

OEM TO ASI EQUIVALENT CROSS REFERENCE

EQUIV MN	EQUIV PN	EQUIV OEM	JC-AIR PN	ASI MN	DESCRIPTION
DFT-75A	2041520-7501	HONEYWELL (BENDIX)		ASI-804	ADF TEST PANEL
DFT-75B	2041597-7501	HONEYWELL (BENDIX)		ASI-804-1	ADF ANTENNA TEST SET
DMT-37A	2041594-3701	HONEYWELL (BENDIX)		ASI-801	DME TEST PANEL
F231-01		PACIFIC ELECTRO DYNAMICS		ASI-369	TEST FIXTURE FOR PACIFIC ELECTRO DYNAMICS 231-2
G215-290005	G215-290005-83	BOMBARDIER (CANADAIR)		ASI-G215-290005	TEST BOX WITH 5 CABLES
G48C	013-1569-010	ROCKWELL COLLINS		ASI-1569-010	ANTENNA FOR 972Q-4 / AN/ARM-186
GSM-100	7010568-901	HONEYWELL		ASI-267	GYRO SIMULATOR
HTS-110	2900-00110-000	HARBIN ELECTRONICS		ASI-110-1	SOLID STATE DIGITAL SYNCHRO (ACCURACY +/- 0.067 DEGREES / 4 MIN)
HTS-110	2900-00110-001	HARBIN ELECTRONICS		ASI-110-2	SOLID STATE DIGITAL SYNCHRO (ACCURACY +/- 0.033 DEGREES / 2 MIN)
HTS-1101		HARBIN ELECTRONICS		ASI-115	INDICATOR TEST PANEL FOR C-6()
HTS-61	2900-00061-000	HARBIN ELECTRONICS		ASI-61	ADF ANTENNA SIMULATOR (19 INCH RACK MOUNT CASE)
HTS-83C	2900-00083-001	HARBIN ELECTRONICS		ASI-83C	AUDIO WATT METER (2mW TO 200 WATTS)
HWX-650/870	T334612	HONEYWELL		ASI-263	PRIMUS-450/650/870 RADAR TEST PANEL
HWX-660/880	T336162	HONEYWELL (SPERRY)		ASI-263-2	PRIMUS-331/440/660/880 RADAR TEST SET
HWX-700	7015455-901	HONEYWELL	01-0169-00	ASI-266-2	PRIMUS 700/701 TEST PANEL
HWX-700A	T337333	HONEYWELL		ASI-266-2A	PRIMUS-700/700A/701/701A RADAR TEST PANEL (REPLACES ASI-266-2)
HWX-800	T334714	HONEYWELL		ASI-266	PRIMUS-800 TEST PANEL
IUT-1MB	3614662-0101	HONEYWELL (BENDIX)		ASI-423-2	CONTROL TEST PANEL
IUT-1SB	3614367-0101	HONEYWELL (BENDIX)	01-0168-00	ASI-423-1	AUXILIARY INTERFACE UNIT TEST PANEL
JF-380A	570-7997-01	L3 (JET)		ASI-19-61A	CABLE: ASI-196-1 TO PS-850() / PS-855()
JT-135A	570-7936-01	L3 (JET)		ASI-196-2	TEST SET FOR PS-834() (WITH 1 CABLE)
JT-138A	570-7996-01	L3 (JET)		ASI-196-1	TEST SET FOR PS-850() / PS-855()
KA-579A	064-1034-01	HONEYWELL (BENDIX/KING)		ASI-71	TEST POWER SUPPLY FOR KFS CONTROLS
KTS-152	071-5026-00	HONEYWELL (BENDIX/KING)		ASI-772	KG-102/102A/105 GYRO TEST PANEL
KTS-153	071-5027-00	HONEYWELL (BENDIX/KING)		ASI-773	KI-525/525A TEST PANEL
KTS-157	071-5040-00	HONEYWELL (BENDIX/KING)		ASI-708-1	HF/SSB TEST SET
KTS-192	NPN	HONEYWELL (BENDIX/KING)		ASI-792	PROBE/ANTENNA COUPLER TESTER FOR KAC-992 (INCL ASI-792-1/-2)
MST-901	622-6100-001	ROCKWELL COLLINS		ASI-241	MICROPROCESSOR SYSTEM TEST SET ADAPTER
MST-902	622-6101-001	ROCKWELL COLLINS		ASI-723	MICROPROCESSOR SYSTEM TEST SET ADAPTER
MST-903	622-6102-001	ROCKWELL COLLINS	01-0335-00	ASI-713	MICROPROCESSOR SYSTEM TEST SET ADAPTER
MST-904	622-6103-001	ROCKWELL COLLINS		ASI-706	MICROPROCESSOR SYSTEM TEST SET ADAPTER
MST-905	622-6104-001	ROCKWELL COLLINS	01-0575-00	ASI-716	MICROPROCESSOR SYSTEM TEST SET ADAPTER
MT-3726	522-4818-001	ROCKWELL COLLINS		ASI-789-2	TEST MOUNT
MX-9626 / ARM	623-5404-001	ROCKWELL COLLINS	01-0121-00	ASI-313	ARC-159 TRANSLATOR MODULE EXTENDER
PPF-200	622-3839-001	ROCKWELL COLLINS		ASI-338-6	PROM FREQUENCY PROGRAMMER
PPT-1A	2037738-0501	HONEYWELL (BENDIX)		ASI-173	PPI-1() RADAR IND TEST PANEL
PPT-1B	2038141-0501	HONEYWELL (BENDIX)		ASI-174	PPI-1() RADAR IND TEST PANEL
PPT-1CG	2041323-0101	HONEYWELL (BENDIX)		ASI-197	PPI-1U TEST PATTERN GEN
PPT-1FB	2041350-0101	HONEYWELL (BENDIX)		ASI-244-1	RADAR INDICATOR TEST PANEL
PPT-1FB	2041350-0102	HONEYWELL (BENDIX)	01-0881-10	ASI-244-2	RADAR INDICATOR TEST PANEL
PPT-4A	2041591-0401	HONEYWELL (BENDIX)		ASI-760	RADAR INDICATOR TEST PANEL
PSD40-503		AEROFLEX (JcAIR)		ASI-1009	CABLE: 727-737
RCT-1500A	3614129-1501	HONEYWELL (BENDIX)	01-0122-00	ASI-426	RDR-1500() RADAR SYSTEM TEST PANEL (W/10 CABLES)
RCT-1F	2038326-0501	HONEYWELL (BENDIX)	01-0123-00	ASI-154-1	RDR-1F RADAR SYSTEM TEST PANEL
RCT-1FB	2041349-0101	HONEYWELL (BENDIX)		ASI-154-2	RDR-1FB RADAR SYSTEM TEST PANEL
RCT-4A	2041589-0401	HONEYWELL (BENDIX)		ASI-742	RADAR SYSTEM TEST PANEL
RDT-1A	2037736-0501	HONEYWELL (BENDIX)		ASI-171	RDR-1E RADAR TEST PANEL
RDT-1B	2037737-0501	HONEYWELL (BENDIX)		ASI-172	ANT-1() RADAR ANT TEST PANEL
RDT-1F	2038139-0501	HONEYWELL (BENDIX)		ASI-152-1	BENDIX RDR-1F R/T TEST PANEL
RDT-1FB	2041351-0102	HONEYWELL (BENDIX)		ASI-152-2	BENDIX RDR-1FB R/T TEST PANEL
RFT-1A	2038142-0501	HONEYWELL (BENDIX)		ASI-170	RDR-1F RADAR RAMP TEST SET
RIG-32A	2070776-3201	HONEYWELL (BENDIX)	01-0758-00	ASI-413-2	ILS AUDIO GENERATOR
RIT-32A	2070809-3201	HONEYWELL (BENDIX)		ASI-413-1	ILS RECEIVER TEST PANEL
RMT-4A	8055325-0401	HONEYWELL (BENDIX)	01-0120-00	ASI-741	DOPPLER SIGNAL GENERATOR
RNT-260A	4000951-6002	HONEYWELL (BENDIX)		ASI-177-2	VOR/ILS SYSTEM TEST PANEL (USCG VERSION)
RNT-260A	4000951-6004	HONEYWELL (BENDIX)		ASI-177-2-04	VOR/ILS SYSTEM TEST PANEL
RNT-26A	2064139-0501	HONEYWELL (BENDIX)		ASI-177-1	VHF-NAV TEST SET
RNT-30A	2041634-3001	HONEYWELL (BENDIX)		ASI-805-1	NAV TEST PANEL WITH RIA-35A/35B CABLE
RNT-30A	2041634-3002	HONEYWELL (BENDIX)		ASI-805-2	NAV TEST PANEL WITH RVA-36A CABLE
RNT-30A	2041634-3003	HONEYWELL (BENDIX)		ASI-805	NAV TEST PANEL WITH RIA-35A/35B AND RVA-36A CABLES
RNT-34A	2041341-3401	HONEYWELL (BENDIX)		ASI-420-1	RNA-34 ADAPTER PANEL
RST-1A	2064746-0501	HONEYWELL (BENDIX)		ASI-169	RDR-1E STAB RAMP TEST SET
RST-4A	2041797-0401	HONEYWELL (BENDIX)		ASI-169-2	RTA-4A RADAR TEST SET
RTT-41A	2037676-0501	HONEYWELL (BENDIX)		ASI-425	TRANSCEIVER TEST PANEL FOR RTA-41A/42A/43A/83A, KTR-9100A
RTT-44A	2041524-4401	HONEYWELL (BENDIX)		ASI-803	VHF COMM TEST PANEL
RVG-33A	2070810-3301	HONEYWELL (BENDIX)		ASI-424-2	VOR AUDIO GENERATOR
RVT-33A	2070811-3301	HONEYWELL (BENDIX)		ASI-424-1	VOR RECEIVER TEST PANEL
T9-1-14-0039	7012-1403-900	AEROFLEX (IFR)		ASI-399	DME 2-PULSE GENERATOR
TA-500	190-3006-01	HONEYWELL (ALLIED SIGNAL)		ASI-359-1	5ATI TEST PANEL
TA-810A	4000866-1001	HONEYWELL (BENDIX)		ASI-780-2	TEST ADAPTER (INCLUDED WITH ASI-780-1)
TE-9200	622-9418-001	ROCKWELL COLLINS		ASI-777-2	HF-9000 SYSTEM TEST SET
TE-9210	822-1429-001	ROCKWELL COLLINS		ASI-777	HF-9000 SYSTEM TEST SET (INCL FUNCTIONS OF THE TE-9200 AND TE-9600)
TE-9300	622-9419-001	ROCKWELL COLLINS		ASI-777-3	HF-9000 PROCESSOR TEST SET
TE-9400	622-9420-001	ROCKWELL COLLINS		ASI-778	HF-9000 EXTENDER SET
TE-9500	822-0092-001	ROCKWELL COLLINS		ASI-777-4	HF-9000 RF TUNER TEST SET
TE-9600	822-0880-001	ROCKWELL COLLINS		ASI-777-5	HF-9000 ARINC TEST SET
TEE-5	822-1051-001	ROCKWELL COLLINS		ASI-758-1	AAMP5 WITH 512K HISTORY
TEE-5	822-1051-002	ROCKWELL COLLINS		ASI-758-2	AAMP5 WITH 128K HISTORY
TEE-5	822-1051-003	ROCKWELL COLLINS		ASI-758-3	AAMP2/2 -8/3 WITH 512K HISTORY
TEE-5	822-1051-004	ROCKWELL COLLINS		ASI-758-4	AAMP2/2 -8/3 WITH 128K HISTORY
TR5260-1		AVTECH		ASI-349-4	5250-1 TEST PANEL
TR5260-40-9	2361-1	AVTECH	01-0371-00	ASI-349-3	5261/5260-1 STATION CARD TEST PANEL
TR5264-1		AVTECH	01-0248-00	ASI-349-2	5264-1 TEST PANEL
TR5289-1	2482-1 / 2488-1	AVTECH	01-0379-00	ASI-349-1	5088-1/5289-1/5082-1 TEST PANEL
TS-1207A	4000595-0701	HONEYWELL (BENDIX)		ASI-1207-A	RT-1201A RADAR TEST SET

OEM TO ASI EQUIVALENT CROSS REFERENCE

<u>EQUIV MN</u>	<u>EQUIV PN</u>	<u>EQUIV OEM</u>	<u>JC-AIR PN</u>	<u>ASI MN</u>	<u>DESCRIPTION</u>
TS-1949A	757-8650-003	ROCKWELL COLLINS		ASI-8650-003	RADIO SET TEST HARNESS (P/O ASI-209-2B)
TS-2502/ARM-93	762-4458-001	ROCKWELL COLLINS		ASI-201-1TS	ADF TEST SET (P/O ASI-201-1)
TS-2544	522-4817-001	ROCKWELL COLLINS		ASI-789-1	TEST SET
TS-3487	623-5464-001	ROCKWELL COLLINS		ASI-312	ARC-159 POWER AMP / POWER SUPPLY TEST SET
TS-3488	623-5465-001	ROCKWELL COLLINS		ASI-311	ARC-159 CONTROL TEST SET
TS-488A/UP	279-0176-010	ROCKWELL COLLINS		ASI-488	ECHO BOX PANEL (MODIFIED PER COLLINS WRT-701X FLW MANUAL)
TS-810A	4000385-1002	HONEYWELL (BENDIX)		ASI-780-1	FCS-810 FLIGHT CONTROL SYSTEM TEST PANEL
TS-870A	4001357-7001	HONEYWELL (BENDIX)		ASI-780-3	FCS-870 FLIGHT CONTROL SYSTEM TEST PANEL
WJB-701	622-5760-001	ROCKWELL COLLINS		ASI-738	WXR-700X J-BOX
WMT-701X	646-4443-009	ROCKWELL COLLINS		ASI-722	WMT-701X TEST TRAY
	40068	ROCKWELL COLLINS		ASI-72-5B	BUBBLE LEVEL FOR ASI-725 LEVELING BASE
	71572	HONEYWELL (GRIMES)		ASI-1034	POWER SUPPLY TESTER FOR GRIMES 60-1321-X
	170130	KIDDE AEROSPACE		ASI-1011	CARGO ELECTRONIC UNIT (CEU) TEST SET
	170145	KIDDE AEROSPACE		ASI-1011-1	CABLE SET FOR ASI-1011 (170130) CEU TEST SET (INCLUDES W1 AND W2)
	170180	KIDDE AEROSPACE		ASI-1016	DETECTION / SUPPRESSION PANEL
	170192	KIDDE AEROSPACE		ASI-1016-1	DETECTION / SUPPRESSION PANEL TEST CABLE
	170222	KIDDE AEROSPACE		ASI-1017	TIMER MONITOR
	170228	KIDDE AEROSPACE		ASI-1016-2	CIRCUIT CARD / CONNECTOR ASSY TEST CABLE (PRE SB 473955-1-26-404)
	170395	KIDDE AEROSPACE		ASI-1016-3	CIRCUIT CARD / CONNECTOR ASSY TEST CABLE (POST SB 473955-1-26-404)
	835000	CABLEWAVE		ASI-835000	500 NS DELAY LINE
	920032	ROCKWELL COLLINS		ASI-920032	CABLE: ANTENNA ADAPTER
	931402	ROCKWELL COLLINS		ASI-931402	CABLE: ANT/DAU
	002-00544-0000	HONEYWELL (BENDIX/KING)		ASI-794	KX-155/165 SYSTEM BENCH TEST SET
	002-00566-0000	HONEYWELL (BENDIX/KING)		ASI-791	KNR-634/634A TEST PANEL (KN4-634A MAN FIG 5-1)
	002-00608-0000	HONEYWELL (BENDIX/KING)		ASI-776-1	KDM-7060 DME BENCH TEST SET
	002-00615-0000	HONEYWELL (BENDIX/KING)		ASI-776-3	KDM-7070 DME BENCH TEST SET
	002-0609-00	HONEYWELL (BENDIX/KING)		ASI-776-2	KDM-706A OPTIONAL BENCH TEST SET
	005-02101-0070	HONEYWELL (BENDIX/KING)		ASI-81-01E	TEST PROM FOR DF-431B
	023-0113-00	HONEYWELL (BENDIX/KING)		ASI-147	DEVIATION METER (100-0-100 uA)
	023-0114-00	HONEYWELL (BENDIX/KING)		ASI-146	FLAG METER (0-500 uA)
	023-0127-00	HONEYWELL (BENDIX/KING)		ASI-145	TO-FROM METER (500-0-500 uA)
	024-0458-000	ROCKWELL COLLINS	70-9001-00	ASI-227	TUNING TOOL
	024-0817-010	ROCKWELL COLLINS		ASI-228	TUNING TOOL
	050-1571-01	HONEYWELL (BENDIX/KING)		ASI-150-1	UNIVERSAL TRACK SELECTOR WITH (30/400 HZ SWITCH PER KING SM105)
	050-2605-00	HONEYWELL (BENDIX/KING)		ASI-050-2605-00	ASYNCH CARD KIT WITH 3 CABLES
	050-2606-00	HONEYWELL (BENDIX/KING)		ASI-050-2606-00	SYNC CARD KIT WITH 2 CABLES
	071-00168-0000	HONEYWELL (BENDIX/KING)		ASI-784	BREAKOUT / TEST PANEL FOR KMD-540
	071-0123-00	HONEYWELL (BENDIX/KING)		ASI-70-8C	CABLE: ASI-708-1 (KTS-157) TO KTR-953
	071-0168-00	HONEYWELL (BENDIX/KING)		ASI-784	BREAKOUT / TEST PANEL FOR KMD-540
	071-5045-00	HONEYWELL (BENDIX/KING)		ASI-70-8B	ANTENNA SIMULATOR
	071-5078-00	HONEYWELL (BENDIX/KING)		ASI-70-8A	CABLE: ASI-708-1 (KTS-157) TO KA-594/KFS-594
	071-5079-00	HONEYWELL (BENDIX/KING)		ASI-792-1	BENCH TEST SET (P/O ASI-792)
	071-5080-00	HONEYWELL (BENDIX/KING)		ASI-792-2	ANTENNA LOAD BOX (P/O ASI-792)
	099-4386-000	ROCKWELL COLLINS		ASI-721	PAU-700 TEST FIXTURE
	099-4421-000	ROCKWELL COLLINS		ASI-765	CMU-900 POWER SUPPLY TEST SET
	101-00908	BARFIELD		ASI-101-00908	CABLE: TT1000A TO CF6/CF8-50
	101149-01-01	SMITHS		ASI-1013-1	CTI TEST SET CABLE FOR SMITHS 2263-01
	110-0440-201	ATLANTIS		ASI-110-0440-201	CABLE: ARA-02 TO 860F-1/-4
	110-0440-202	ATLANTIS		ASI-110-0440-202	CABLE: ARA-02 TO 339H-1/-2
	110-0440-203	ATLANTIS		ASI-110-0440-203	CABLE: ARA-02 TO 860F-1/-4 J9
	110-344	AVIONICS SPECIALTIES		ASI-110-344	CABLE: TEST SET J4 TO INTERFACE P1
	1162291-100	HONEYWELL		ASI-380	DPCU UNIT TESTER
	1165-40-1	ROCKWELL COLLINS		ASI-811-4	TEST SET FOR 1165-1 (AIRSHOW / CABIN SYSTEMS)
	117-0016-038	ROCKWELL COLLINS		ASI-0016-038	ERECTION ACCURACY FIXTURE
	117-0600-107	ROCKWELL COLLINS		ASI-40-41G	BCA-770 MOUNT ASSY DRILLING AND PINNING TEST FIXTURE
	1226-40-1	ROCKWELL COLLINS		ASI-811-5	TEST SET FOR 1226-1 (AIRSHOW / CABIN SYSTEMS)
	1287-40-1	ROCKWELL COLLINS		ASI-811-6	TEST SET FOR 1287-1 (AIRSHOW / CABIN SYSTEMS)
	131-3605-422	ROCKWELL COLLINS		ASI-40-41E	BCA-770 MOUNT ASSEMBLY PRELOAD TEST FIXTURE
	131-3605-423	ROCKWELL COLLINS		ASI-40-41F	BCA-770 MOUNT ASSEMBLY FORCE-PULL TEST FIXTURE
	131-3605-464	ROCKWELL COLLINS		ASI-40-41D	BCA-770 OVERRIDE SLIP CLUTCH TEST FIXTURE
	131-3605-469	ROCKWELL COLLINS		ASI-40-41H	BCA-770 MOTOR TENTION ADJUSTOR
	131-3606-179	ROCKWELL COLLINS		ASI-722-10	WAVEGUIDE SWITCH TESTER FOR WMT-701X
	135-3602-122	ROCKWELL COLLINS		ASI-34-8C	BALL BEARING ASSEMBLY FIXTURE
	135-3602-961	ROCKWELL COLLINS		ASI-34-8B	BALL BEARING INNER RACE REMOVAL TOOL
	135-3603-026	ROCKWELL COLLINS		ASI-269-1A	DIAL INDICATOR MOUNTING POST (3 INCH)
	135-3603-027	ROCKWELL COLLINS		ASI-269-1B	DIAL INDICATOR MOUNTING POST (6 INCH)
	135-3605-097	ROCKWELL COLLINS		ASI-3605-097	DSP-200 TORQUE ADJUSTMENT TOOL
	155-1442-00	HONEYWELL (BENDIX/KING)		ASI-793	KHF990 (KAC-992/KTR-993/KFS-594) SYSTEM TEST HARNESS
	155-2058-01	HONEYWELL (BENDIX/KING)		ASI-77-3A	CABLE: ASI-773 (KTS-153) TO KI-525/525A TOP PLUG (CABLE 1)
	155-2058-02	HONEYWELL (BENDIX/KING)		ASI-77-3B	CABLE: ASI-773 (KTS-153) TO KI-525/525A BOTTOM PLUG (CABLE 2)
	155-J082-01	HONEYWELL (BENDIX/KING)		ASI-70-8D	CABLE: ASI-708-1 (KTS-157) TO KCU-1051
	1711819-502	HONEYWELL (SPERRY)		ASI-27-0B	CABLE: ASI-270(J1) TO IF(P404)
	1711819-503	HONEYWELL (SPERRY)		ASI-27-0C	CABLE: ASI-270(J2) TO GENERATOR
	1711819-504	HONEYWELL (SPERRY)		ASI-27-0A	CABLE: ASI-270(J3) TO AFC(P501)
	1717866-501	HONEYWELL (SPERRY)		ASI-27-0D	DUMMY MIXER: IF AMP ALIGN AND BANDWIDTH
	1717868-501	HONEYWELL (SPERRY)		ASI-27-0E	DUMMY MIXER: IF AMP AND ISOCONTOUR
	1717869-503	HONEYWELL (SPERRY)		ASI-27-0F	DUMMY MIXER: AFC BANDPASS FILT / DESC
	1730-40-1	ROCKWELL COLLINS		ASI-811-7	TEST SET FOR 1730-1 (AIRSHOW / CABIN SYSTEMS)
	2020-1	AVTECH		ASI-349-5	TEST SET FOR 5141 / 5144 / 5145 CONTROL PANELS
	2020-1-1	AVTECH		ASI-349-50	AVTECH 5145-1-XX SELCAL TESTER
	2020-1-2	AVTECH		ASI-349-51	SELCAL TESTER FOR 5145-1
	2034175-0002	HONEYWELL (BENDIX)		ASI-17-5A	TEST PLACARD
	2034816-0001	HONEYWELL (BENDIX)		ASI-16-9A	TEST PLACARD
	2034816-0002	HONEYWELL (BENDIX)		ASI-16-9B	TEST PLACARD
	2034816-0003	HONEYWELL (BENDIX)		ASI-16-9C	TEST PLACARD

OEM TO ASI EQUIVALENT CROSS REFERENCE

EQUIV MN	EQUIV PN	EQUIV OEM	JC-AIR PN	ASI MN	DESCRIPTION
	2035426-0002	HONEYWELL (BENDIX)		ASI-17-0A	TEST PLACARD
	2036957-0501	HONEYWELL (BENDIX)		ASI-17-1B	CABLE: ASI-171 (RDT-1A) W2
	2036958-0501	HONEYWELL (BENDIX)		ASI-17-1A	CABLE: ASI-171 (RDT-1A) W1
	2036959-0501	HONEYWELL (BENDIX)		ASI-17-1C	CABLE: ASI-171 (RDT-1A) W3
	2037015-0501	HONEYWELL (BENDIX)	55-0123-00	ASI-17-2C	CABLE: ASI-172 (RDT-1B) TO CON-1A/B/D (W101)
	2037016-0501	HONEYWELL (BENDIX)	55-0123-01	ASI-17-2A	CABLE: ASI-172 (RDT-1B) TO CON-1J/L/N (W102)
	2037017-0501	HONEYWELL (BENDIX)	55-0123-02	ASI-17-2D	CABLE: ASI-172 (RDT-1B) TO CON-1NB (W103)
	2037018-0501	HONEYWELL (BENDIX)	55-0123-04	ASI-17-2B	CABLE: ASI-172 (RDT-1B) TO ANT-1() (W201)
	2037019-0501	HONEYWELL (BENDIX)		ASI-17-2E	CABLE: ASI-172 (RDT-1B) TO ANT-1G (W202)
	2037075-0501	HONEYWELL (BENDIX)	20-5709-00	ASI-19-9I	EXT CARD: ASI-199 (ALT-51A) NARROW
	2037075-0502	HONEYWELL (BENDIX)	20-5709-01	ASI-19-9J	EXT CARD: ASI-199 (ALT-51A) WIDE
	2037517-0501	HONEYWELL (BENDIX)	55-0455-13	ASI-19-9C	CABLE: ASI-199 (ALT-51A) W103
	2037533-0501	HONEYWELL (BENDIX)	55-0455-10	ASI-19-9B	CABLE: ASI-199 (ALT-51A) W102
	2037535-0501	HONEYWELL (BENDIX)		ASI-19-9D	CABLE: ASI-199 (ALT-51A) W104
	2037536-0501	HONEYWELL (BENDIX)	55-0455-08	ASI-19-9A	CABLE: ASI-199 (ALT-51A) W101
	2037543-0501	HONEYWELL (BENDIX)		ASI-17-7A	CABLE: ASI-177-1 (RNT-26A) W105
	2037544-0501	HONEYWELL (BENDIX)		ASI-17-7F	CABLE: ASI-177-1 (RNT-26A) W113
	2037545-0501	HONEYWELL (BENDIX)		ASI-17-7H	CABLE: ASI-177-1 (RNT-26A) W115
	2037546-0501	HONEYWELL (BENDIX)		ASI-17-7G	CABLE: ASI-177-1 (RNT-26A) W114
	2037547-0501	HONEYWELL (BENDIX)		ASI-17-7D	CABLE: ASI-177-1 (RNT-26A) W111
	2037548-0501	HONEYWELL (BENDIX)		ASI-17-7K	CABLE: ASI-177-1 (RNT-26A) W118
	2037549-0501	HONEYWELL (BENDIX)		ASI-17-7E	CABLE: ASI-177-1 (RNT-26A) W112
	2037550-0501	HONEYWELL (BENDIX)		ASI-17-7B	CABLE: ASI-177-1 (RNT-26A) W109
	2037551-0501	HONEYWELL (BENDIX)		ASI-17-7C	CABLE: ASI-177-1 (RNT-26A) W110
	2037551-0502	HONEYWELL (BENDIX)		ASI-17-7J	CABLE: ASI-177-1 (RNT-26A) W117
	2037552-0501	HONEYWELL (BENDIX)		ASI-17-7I	CABLE: ASI-177-1 (RNT-26A) W116
	2037553-0501	HONEYWELL (BENDIX)		ASI-17-7N	LOAD: ASI-177-1 (RNT-26A) PR1
	2037554-0501	HONEYWELL (BENDIX)	55-0455-11	ASI-19-9E	CABLE: ASI-199 (ALT-51A) W105
	2038137-0006	HONEYWELL (BENDIX)		ASI-19-9F	CABLE: ASI-199 (ALT-51A) W111
	2038137-0007	HONEYWELL (BENDIX)	55-0455-06	ASI-19-9G	CABLE: ASI-199 (ALT-51A) W112
	2038137-0008	HONEYWELL (BENDIX)	55-0455-07	ASI-19-9H	CABLE: ASI-199 (ALT-51A) W114
	2038272-0501	HONEYWELL (BENDIX)		ASI-15-2A	CABLE: ASI-152 (RDT-1F) W101
	2038273-0501	HONEYWELL (BENDIX)		ASI-15-2B	CABLE: ASI-152 (RDT-1F) W102
	2038274-0501	HONEYWELL (BENDIX)		ASI-15-2C	CABLE: ASI-152 (RDT-1F) W103
	2038275-0501	HONEYWELL (BENDIX)		ASI-15-2D	CABLE: ASI-152 (RDT-1F) W104
	2038283-0501	HONEYWELL (BENDIX)		ASI-17-4A	CABLE: ASI-174 (PPT-1B) W101
	2038284-0501	HONEYWELL (BENDIX)		ASI-17-4B	CABLE: ASI-174 (PPT-1B) W102
	2038308-0501	HONEYWELL (BENDIX)		ASI-15-3A	CABLE: ASI-153 (ATT-1T) W101
	2038309-0501	HONEYWELL (BENDIX)		ASI-15-3B	CABLE: ASI-153 (ATT-1T) W102
	2038350-0501	HONEYWELL (BENDIX)		ASI-15-4A	CABLE: ASI-154 (RCT-1F) W101
	2038351-0501	HONEYWELL (BENDIX)		ASI-15-4B	CABLE: ASI-154 (RCT-1F) W102
	2038352-0501	HONEYWELL (BENDIX)		ASI-15-4C	CABLE: ASI-154 (RCT-1F) W103
	2038352-0502	HONEYWELL (BENDIX)		ASI-15-42C	CABLE: ASI-154-2 (RCT-1FB) W103
	2038353-0501	HONEYWELL (BENDIX)		ASI-15-4D	CABLE: ASI-154 (RCT-1F) W104
	2038353-0502	HONEYWELL (BENDIX)		ASI-15-42D	CABLE: ASI-154-2 (RCT-1FB) W104
	2038683-0505	HONEYWELL (BENDIX)		ASI-41-3A	CABLE: ASI-413-1 (RIT-32A) W101
	2038692-0501	HONEYWELL (BENDIX)		ASI-42-4A	CABLE: ASI-424-1 (RVT-33A) W101
	2038816-0501	HONEYWELL (BENDIX)		ASI-17-4C	CABLE: ASI-174 (PPT-1B) W103
	2039388-0501	HONEYWELL (BENDIX)		ASI-42-01A	CABLE: ASI-420-1 (RNT-34A) W1
	2039389-0501	HONEYWELL (BENDIX)		ASI-42-01B	CABLE: ASI-420-1 (RNT-34A) W2
	2039446-0501	HONEYWELL (BENDIX)		ASI-42-01C	CABLE: ASI-420-1 (RNT-34A) W3
	2039597-0501	HONEYWELL (BENDIX)		ASI-198	PPI-1U RADAR TEST ADAPTER
	2039608-0501	HONEYWELL (BENDIX)		ASI-24-4A	CABLE: ASI-244-1 (PPT-1FB) W101
	2039608-0502	HONEYWELL (BENDIX)		ASI-24-42A	CABLE: ASI-244-2 (PPT-1FB) W101
	2039817-0501	HONEYWELL (BENDIX)		ASI-244-3	CON-1FB TEST ADAPTER
	2039835-0501	HONEYWELL (BENDIX)		ASI-80-XE	EXTENDER BOARD: TEST SET MODULE
	2039960-050	HONEYWELL (BENDIX)		ASI-722-3	COOLING UNIT
	2039960-0501	HONEYWELL (BENDIX)		ASI-722-2	RTA-4A COOLING MOUNT
	2039994-0501	HONEYWELL (BENDIX)		ASI-74-2A	CABLE: ASI-742 (RCT-4A) W1
	2039995-0501	HONEYWELL (BENDIX)		ASI-74-2B	CABLE: ASI-742 (RCT-4A) W2
	2039996-0501	HONEYWELL (BENDIX)		ASI-74-2C	CABLE: ASI-742 (RCT-4A) W3
	2039997-0501	HONEYWELL (BENDIX)		ASI-74-2D	CABLE: ASI-742 (RCT-4A) W4
	2039998-0501	HONEYWELL (BENDIX)		ASI-74-2E	CABLE: ASI-742 (RCT-4A) W5
	2039999-0501	HONEYWELL (BENDIX)		ASI-74-2F	CABLE: ASI-742 (RCT-4A) W6
	2040000-0501	HONEYWELL (BENDIX)		ASI-74-2G	CABLE: ASI-742 (RCT-4A) W7
	2040020-0501	HONEYWELL (BENDIX)		ASI-25-22B	CABLE: ASI-252-2 (COT-4A) W2
	2040020-0501	HONEYWELL (BENDIX)		ASI-42-6H	CABLE: ASI-426 TO AC POWER (W8)
	2040020-0501	HONEYWELL (BENDIX)		ASI-77-0B	CABLE: ASI-770 (AST-4A) W108
	2040020-0501	HONEYWELL (BENDIX)		ASI-77-1D	CABLE: ASI-771 (ATT-4A) W4
	2040020-0502	HONEYWELL (BENDIX)		ASI-80-XB	CABLE: POWER 115 VAC 400 HZ
	2040030-0501	HONEYWELL (BENDIX)		ASI-76-0A	CABLE: ASI-760 (PPT-4A) TO PPI-4B W1
	2040035-0501	HONEYWELL (BENDIX)		ASI-25-22A	CABLE: ASI-252-2 (COT-4A) W1
	2040065-0501	HONEYWELL (BENDIX)		ASI-80-1A	CABLE: ASI-801 (DMT-37A) TO DMA-37A
	2040070-0501	HONEYWELL (BENDIX)		ASI-80-2A	CABLE: ASI-802 (ALT-52A) TO ALA-52A
	2040082-0501	HONEYWELL (BENDIX)		ASI-77-1B	CABLE: ASI-771 (ATT-4A) W2
	2040083-0501	HONEYWELL (BENDIX)		ASI-77-1A	CABLE: ASI-771 (ATT-4A) W1
	2040085-0501	HONEYWELL (BENDIX)		ASI-80-5A	CABLE: ASI-805-X (RNT-30A) TO RIA-35A AND RIA-35B
	2040156-0501	HONEYWELL (BENDIX)		ASI-804-2	ADF ANTENNA HOLDER FIXTURE
	2040179-0501	HONEYWELL (BENDIX)		ASI-80-XF	EXTENDER BOARD: TEST SET MODULE
	2040282-0504	HONEYWELL (BENDIX)		ASI-80-3A	CABLE: ASI-803 (RTT-44A) AND RTA-83B
	2040300-0501	HONEYWELL (BENDIX)		ASI-80-4A	CABLE: ASI-804-1 (DFT-75A) TO DFA-75A
	2040331-0501	HONEYWELL (BENDIX)		ASI-77-0A	CABLE: ASI-770 (AST-4A) W101
	2040410-0501	HONEYWELL (BENDIX)		ASI-80-XC1	WRAP-AROUND TEST CONNECTOR
	2040661-0501	HONEYWELL (BENDIX)		ASI-42-31A	CABLE: ASI-423-1 (IUT-1SB) W4
	2040662-0501	HONEYWELL (BENDIX)		ASI-42-31B	CABLE: ASI-423-1 (IUT-1SB) W6

OEM TO ASI EQUIVALENT CROSS REFERENCE

EQUIV MN	EQUIV PN	EQUIV OEM	JC-AIR PN	ASI MN	DESCRIPTION
	2040663-0501	HONEYWELL (BENDIX)		ASI-42-31C	CABLE: ASI-423-1 (IUT-1SB) W7
	2040692-0501	HONEYWELL (BENDIX)		ASI-80-XG	CABLE: 28 VDC POWER
	2040840-0501	HONEYWELL (BENDIX)		ASI-42-31D	CABLE: ASI-423-1 (IUT-1SB) W8
	2040903-0501	HONEYWELL (BENDIX)		ASI-80-XC2	WRAP-AROUND TEST CONNECTOR
	2040904-0501	HONEYWELL (BENDIX)		ASI-74-2K	CABLE: ASI-742 W4 (ASI-74-2D) TO DAA-4B
	2040981-0501	HONEYWELL (BENDIX)		ASI-77-1C	CABLE: ASI-771 (ATT-4A) W3
	2041574-0502	HONEYWELL (BENDIX)		ASI-15-42B	CABLE: ASI-154-2 (RCT-1FB) W102
	2041579-0502	HONEYWELL (BENDIX)		ASI-25-2A	CABLE: ASI-252-1 (COT-1FB) W101
	2041580-0501	HONEYWELL (BENDIX)		ASI-25-2B	CABLE: ASI-252-1 (COT-1FB) W102
	2041779-0501	HONEYWELL (BENDIX)		ASI-80-5B	CABLE: ASI-805-X (RNT-30A) TO RVA-36A
	2064754-0501	HONEYWELL (BENDIX)		ASI-20-2C	CABLE: ASI-202 (DFT-73AA) W103
	2064756-0501	HONEYWELL (BENDIX)		ASI-20-2A	CABLE: ASI-202 (DFT-73AA) W101
	2065171-0501	HONEYWELL (BENDIX)		ASI-20-2D	CABLE: ASI-202 (DFT-73AA) CONTROL
	2065171-0502	HONEYWELL (BENDIX)		ASI-20-2E	CABLE: ASI-202 (DFT-73AA) CONTROL
	2065211-0501	HONEYWELL (BENDIX)		ASI-20-2B	CABLE: ASI-202 (DFT-73AA) W102
	2068253-0701	HONEYWELL (BENDIX)		ASI-19-9F	CABLE: ASI-199 (ALT-51A) W113
	2068256-0701	HONEYWELL (BENDIX)		ASI-199-3	650 nS DELAY LINE (P/O ASI-199)
	221-2171-010	ROCKWELL COLLINS		ASI-2171-010	NICAD BATTERY FOR 972Q-4/AN/ARM-186 (REPL 629-0999-001 PER SIL 1-99)
	226-40-1	ROCKWELL COLLINS		ASI-811-1	TEST SET FOR 226-1 (AIRSHOW / CABIN SYSTEMS)
	229-0223-030	ROCKWELL COLLINS		ASI-230	FLUX KEEPER RING
	229-0319-070	ROCKWELL COLLINS		ASI-0319-070	SVO-85/1000 FLUX KEEPER
	229-0319-120	ROCKWELL COLLINS		ASI-0319-120	SVO-1000 FLUX KEEPER
	229-9515-050	ROCKWELL COLLINS		ASI-232	MAGNET KEEPER
	23-23-00-0054	HONEYWELL		ASI-336	SELCAL DECODER TESTER
	245-0012-00	HONEYWELL (BENDIX/KING)		ASI-0012-00	CABLE: EGPWS (LRU TEST CABLE)
	263TS101-1	ACME AEROSPACE		ASI-604-1	BATTERY CHARGER TEST SET
	263TS302-1	ACME AEROSPACE		ASI-60-41D	CABLE: 263BC101 A2P1 EXTENDER
	263TS303-1	ACME AEROSPACE		ASI-60-41E	CABLE: 263BC101 A2J1 EXTENDER
	270-2635-010	ROCKWELL COLLINS		ASI-2635-010	BATTERY CHARGER FOR 972Q-4 / AN/ARM-186 WITH NICAD BATTERIES)
	303-0005-001	ROCKWELL COLLINS		ASI-803-1	2X5 TUNING PANEL FOR RTA-83A
	3604049-0501	HONEYWELL (BENDIX)		ASI-17-72B	CABLE: ASI-177-2 (RNT-260A) TO CONTROL
	3604050-0501	HONEYWELL (BENDIX)		ASI-17-72A	CABLE: ASI-177-2 (RNT-260A) TO R-2032 / R-2325
	3604321-0501	HONEYWELL (BENDIX)		ASI-17-72H	CABLE: ASI-177-2 (RNT-260A) TO C-10048 / C-10049
	3604322-0501	HONEYWELL (BENDIX)		ASI-17-72G	CABLE: ASI-177-2 (RNT-260A) TO R-2023 / R-2139
	3604357-0501	HONEYWELL (BENDIX)		ASI-17-72D	CABLE: GS COAX
	3604357-0502	HONEYWELL (BENDIX)		ASI-17-72E	CABLE: VOR/LOC COAX
	3604357-0503	HONEYWELL (BENDIX)		ASI-17-72F	CABLE: MB COAX
	3604357-0504	HONEYWELL (BENDIX)		ASI-17-72D1	CABLE: GS COAX
	3604357-0505	HONEYWELL (BENDIX)		ASI-17-72E1	CABLE: VOR/LOC COAX
	3604357-0506	HONEYWELL (BENDIX)		ASI-17-72F1	CABLE: MB COAX
	3611841-0001	HONEYWELL (BENDIX)		ASI-16-92A	TEST PLACARD
	372-8092-010	ROCKWELL COLLINS		ASI-8092-010	CRIMPING TOOL 90202-1 / 91516-1
	372-8093-010	ROCKWELL COLLINS		ASI-8093-010	EXTRACTION TOOL (SAME AS ASI-0519-001)
	372-8093-010	ROCKWELL COLLINS		ASI-0519-001	THINLINE EXTRACTOR (TOOL 751-0519-001 & HANDLE 007-0611-000)
	4000601-0000	HONEYWELL (BENDIX)		ASI-360-3	DA 1203 ANTENNA TEST PANEL
	4000611-0000	HONEYWELL (BENDIX)		ASI-360-1	RDR SYSTEM TEST PANEL
	4000614-0000	HONEYWELL (BENDIX)		ASI-360-5	DA 1203 ANTENNA RUN-IN TEST PANEL
	4001740-0000	HONEYWELL (BENDIX)		ASI-360-4	AN/APN-215 / DA-1203 ANTENNA RUN-IN TEST PANEL
	4007102-0501	HONEYWELL (BENDIX)		ASI-78-01A	CABLE: ASI-780-1 (P1/P2) TO COMPUTER WITH AMP CONN (TS-810A-02 SB)
	4007107-0501	HONEYWELL (BENDIX)		ASI-78-01E	CABLE: ASI-780-1 (P5) TO PWR SUPPLY WITH AMP CONN (TS-810A-02 SB)
	4007114-0501	HONEYWELL (BENDIX)		ASI-78-01B	CABLE: ASI-780-1 (P6) TO ROLL SERVO WITH AMP CONN (TS-810A-02 SB)
	4007114-0503	HONEYWELL (BENDIX)		ASI-78-01D	CABLE: ASI-780-1 (P8) TO TRIM SERVO WITH AMP CONN (TS-810A-02 SB)
	4374-01	SMITHS		ASI-1013	CTI TEST SET
	44127-001	HONEYWELL (BENDIX/KING)		ASI-80-XA	CABLE: POWER 115 VAC 60 HZ
	442-0795-001	ROCKWELL COLLINS		ASI-0795-001	POWER ADAPTER TEST FIXTURE
	458-0815-040	ROCKWELL COLLINS		ASI-203-M1K	980N-1 METER (M1) RETROFIT KIT
	460-0079-246	ROCKWELL COLLINS		ASI-40-41B	BCA-770 SERVO MOUNT PRESSURE LEAK TEST ASSEMBLY
	467-102-002	GULL		ASI-467-102-002	CABLE: GTF-6 INPUT POWER
	467-114-002	GULL		ASI-467-114-002-BK	CABLE: GTF-6 TEST LEAD, BLACK
	467-114-002	GULL		ASI-467-114-002	CABLE: GTF-6 TEST LEAD, RED
	467-117-002	GULL		ASI-467-117-002	CABLE: GTF-6 CONP/COAX
	467-118-001	GULL		ASI-467-118-002	CABLE: GTF-6 UNSH EXTENSION
	467-119-002	GULL		ASI-467-119-002	CABLE: GTF-6 CONP/COAX
	467-137-001	GULL		ASI-467-137-001	CABLE: GTF-6 COAX
	467-138-001	GULL		ASI-467-138-001	CABLE: GTF-6 TEST LEAD
	467-139-001	GULL		ASI-467-139-001	CABLE: GTF-6 TEST LEAD
	467-147-001	GULL		ASI-467-147-001	CABLE: GTF-6 COAX
	506-4851-002	ROCKWELL COLLINS		ASI-16-6F	CABLE: COAX
	522-4855-001	ROCKWELL COLLINS		ASI-78-9A	CABLE: ASI-789 (AN/ARM-102) W1
	522-4856-001	ROCKWELL COLLINS		ASI-78-9B	CABLE: ASI-789 (AN/ARM-102) W2
	522-4857-001	ROCKWELL COLLINS		ASI-78-9C	CABLE: ASI-789 (AN/ARM-102) W3
	522-4939-001	ROCKWELL COLLINS		ASI-78-9D	CABLE: ASI-789 (AN/ARM-102) W4
	540-7244-000	ROCKWELL COLLINS		ASI-16-6D	30 HZ FILTER FOR ASI-166 (479X-2)
	540-7245-000	ROCKWELL COLLINS		ASI-16-6A	CABLE: ASI-166 (479X-2) TO OBI
	540-7246-000	ROCKWELL COLLINS		ASI-16-6C	CABLE: ASI-166 (479X-2) TO OBS
	540-7247-000	ROCKWELL COLLINS	55-0033-11	ASI-16-6G	CABLE: VOLTMETER
	544-5037-002	ROCKWELL COLLINS		ASI-19-2B	CABLE: ASI-192 (477U-2) RF SIM CABLE
	545-2501-003	ROCKWELL COLLINS		ASI-49-96E	CABLE: ASI-49-96C CABLE TO CPU-4A (NON-COLLINS)
	545-4557-003	ROCKWELL COLLINS	55-0156-04	ASI-49-96A	CABLE: ASI-499-6 (476E-1A) POWER
	545-4559-003	ROCKWELL COLLINS		ASI-79-94A	CABLE: ASI-499-1/2/4 TO EXTERNAL POWER
	545-4596-003	ROCKWELL COLLINS		ASI-49-96B	CABLE: ASI-499-6 (476E-1A) TO 476C-2
	545-4604-004	ROCKWELL COLLINS		ASI-79-94B	CABLE: ASI-499-1/2/4 TO HSI AMPLIFIER
	545-4605-004	ROCKWELL COLLINS		ASI-79-94C	CABLE: ASI-499-1/2/4 TO AIRCRAFT INSTRUMENT WIRING
	545-4607-004	ROCKWELL COLLINS		ASI-79-94D	CABLE: ASI-499-1/2/4 TO HSI 1J2
	545-4609-004	ROCKWELL COLLINS		ASI-79-94E	CABLE: ASI-499-1/2/4 TO HSI 1J1

OEM TO ASI EQUIVALENT CROSS REFERENCE

EQUIV MN	EQUIV PN	EQUIV OEM	JC-AIR PN	ASI MN	DESCRIPTION
	545-4615-004	ROCKWELL COLLINS		ASI-49-96C	CABLE: ASI-499-6 (476E-1A) TO CPU-4A
	545-4616-004	ROCKWELL COLLINS		ASI-49-96D	CABLE: ASI-499-6 (476E-1A) TO CPU-4A AND INDICATOR
	546-8436-003	ROCKWELL COLLINS		ASI-79-94F	CABLE: ASI-499-2/4 TO AIRCRAFT INSTRUMENT WIRING
	547-2795-000	ROCKWELL COLLINS		ASI-29-6D	CABLE: ASI-296 (971T-1) RED PROBE
	548-8002-004	ROCKWELL COLLINS		ASI-20-9A	CABLE: ASI-209 TO 618T-1/2/3
	548-8002-005	ROCKWELL COLLINS	55-0480-07	ASI-20-9A1	CABLE: ASI-209 TO 618T-1/2/3
	548-8003-004	ROCKWELL COLLINS		ASI-20-9B	CABLE: ASI-209 TO 516H-1
	548-8003-005	ROCKWELL COLLINS		ASI-20-9B1	CABLE: ASI-209 TO 516H-1
	548-8023-003	ROCKWELL COLLINS		ASI-20-9C	CABLE: ASI-209 TO DC PWR
	548-8023-004	ROCKWELL COLLINS		ASI-20-9C1	CABLE: ASI-209 TO DC PWR
	548-8025-003	ROCKWELL COLLINS		ASI-20-9D	CABLE: ASI-209 TO AC PWR
	548-8025-004	ROCKWELL COLLINS		ASI-20-9D1	CABLE: ASI-209 TO AC PWR
	548-8029-004	ROCKWELL COLLINS		ASI-20-9E	CABLE: ASI-209 (678P-1C) TO 714E-1/2
	548-8029-005	ROCKWELL COLLINS		ASI-20-9E1	CABLE: ASI-209 TO 714E-1/2
	548-8284-004	ROCKWELL COLLINS	55-0480-08	ASI-20-9F	CABLE: ASI-209 (678P-1C) TO 714E-3/6
	548-8284-005	ROCKWELL COLLINS		ASI-20-9F1	CABLE: ASI-209 (678P-1C) TO 714E-3/6
	548-8285-004	ROCKWELL COLLINS	55-0480-12	ASI-90-9G	CABLE: ASI-209 TO 309-A1
	548-8285-005	ROCKWELL COLLINS		ASI-90-9G1	CABLE: ASI-209 TO 309-A1
	548-8286-004	ROCKWELL COLLINS		ASI-20-9H	CABLE: ASI-209 TO 309A-2D
	548-8286-005	ROCKWELL COLLINS		ASI-20-9H1	CABLE: ASI-209 TO 309A-2D
	548-8287-004	ROCKWELL COLLINS		ASI-20-9J	CABLE: ASI-209 TO 180L-2/3
	548-8287-005	ROCKWELL COLLINS		ASI-20-9J1	CABLE: ASI-209 TO 180L-2/3
	548-8292-006	ROCKWELL COLLINS		ASI-8292-006	RADIO TEST HARNESS SUBASSY
	548-9600-004	ROCKWELL COLLINS		ASI-79-94G	CABLE: ASI-499-2 TO AQU-2/A
	549-4334-002	ROCKWELL COLLINS		ASI-20-9K	CABLE: ASI-209 (678P-1C) RF
	549-4334-003	ROCKWELL COLLINS		ASI-20-9K1	CABLE: RF
	549-6540-003	ROCKWELL COLLINS	55-0156-02	ASI-19-2A	CABLE: ASI-192 (477U-2) SENSE CABLE
	549-6543-004	ROCKWELL COLLINS		ASI-19-3B	CABLE: ASI-193 (477V-2) IND PWR CABLE
	549-6544-004	ROCKWELL COLLINS	55-0154-02	ASI-19-3A	CABLE: ASI-193 (477V-2) RECEIVER POWER CABLE
	549-6545-004	ROCKWELL COLLINS	55-0154-01	ASI-19-2C	CABLE: ASI-192 (477U-2) LOOP ANT CABLE
	549-6545-004	ROCKWELL COLLINS		ASI-20-11C	CABLE: ASI-201-1 (AN/ARM-93) LOOP ANTENNA (W3)
	549-6545-004	ROCKWELL COLLINS	55-0156-03	ASI-20-1C	CABLE: ASI-201-2 (477U-3) LOOP ANTENNA (W3)
	55-0215-01	HONEYWELL (BENDIX/KING)		ASI-81-02F	CABLE: ASI-810-2 TO VC-401A
	55-0215-02	HONEYWELL (BENDIX/KING)		ASI-81-02G	CABLE: ASI-810-2 TO VN-411A / KI-227
	55-0215-03	HONEYWELL (BENDIX/KING)		ASI-81-03C	CABLE: ASI-801-3 TO TR-421A
	55-0215-04	HONEYWELL (BENDIX/KING)		ASI-81-03D	CABLE: ASI-801-3 TO DM-441A
	55-0215-05	HONEYWELL (BENDIX/KING)		ASI-81-01C	CABLE: ASI-810-1 TO DF-431A / AT-434A
	55-0215-06	HONEYWELL (BENDIX/KING)		ASI-81-02C	HSI SUBSTITUTION PLUG
	55-0215-13	HONEYWELL (BENDIX/KING)		ASI-81-03A	CABLE: ASI-801-3 TO TR-421B
	55-0215-14	HONEYWELL (BENDIX/KING)		ASI-81-03B	CABLE: ASI-801-3 TO DM-441B
	55-0215-15	HONEYWELL (BENDIX/KING)		ASI-81-01A	CABLE: ASI-810-1 TO DF-431B / AT-434A
	55-0605-11	HONEYWELL (BENDIX/KING)		ASI-81-02A	CABLE: ASI-810-2 TO VC-401B
	55-0605-12	HONEYWELL (BENDIX/KING)		ASI-81-02B	CABLE: ASI-810-2 TO VN-411B / KI-227
	55-0605-13	AEROFLEX (JCAIR)		ASI-55-0605-13	CABLE: PSD60-1AF BNC TO TEST CLIP
	55-0605-14	AEROFLEX (JCAIR)		ASI-55-0605-14	CABLE: PSD60-1AF BNC TO ALIGATOR CLIP
	55-0605-15	AEROFLEX (JCAIR)		ASI-55-0605-15	CABLE: PSD60-1AF BNC TO BNC (48")
	55-0605-16	AEROFLEX (JCAIR)		ASI-55-0605-16	CABLE: PSD60-1AF BNC TO BNC (36")
	55-0780-02	AEROFLEX (JcAIR)		ASI-0780-02	PSDA300-1 CENTER TANK ADAPTER CABLE
	552-4825-000	ROCKWELL COLLINS		ASI-34-62A	CABLE: TEST
	554-2915-004	ROCKWELL COLLINS		ASI-20-9L	CABLE: ASI-20-209 TO CU-351
	554-2915-005	ROCKWELL COLLINS		ASI-20-9L1	CABLE: ASI-20-209 TO CU-351
	554-6109-004	ROCKWELL COLLINS		ASI-19-2D	CABLE: ASI-192 (477U-2) LOW CAP SENS CABLE
	554-6957-001	ROCKWELL COLLINS	55-0156-05	ASI-32-82A	CABLE: W3
	554-6958-001	ROCKWELL COLLINS		ASI-32-83A	CABLE: W4
	55-7002-00	AEROFLEX (JCAIR)		ASI-55-7002-00	CABLE: PSD60-1AF BANANA PLUG TO ALIGATOR CLIP
	601-2123-001	ROCKWELL COLLINS		ASI-CTS-12A1	LABEL CHANGER CARD
	601-2214-001	ROCKWELL COLLINS		ASI-2214-001	EXTENDER CARD FOR ADI-85 (P/O ASI-9999-001 KIT)
	601-2216-001	ROCKWELL COLLINS		ASI-2216-001	EXTENDER CARD FOR ADI-85 A2/A3/A4 (P/O ASI-9999-001 KIT)
	601-2241-001	ROCKWELL COLLINS		ASI-2241-001	EXT CARD: RCVR IF
	601-2242-001	ROCKWELL COLLINS		ASI-2242-001	EXT CARD: AUDIO
	601-2243-001	ROCKWELL COLLINS		ASI-2243-001	EXT CARD: P/S
	601-2244-001	ROCKWELL COLLINS		ASI-2244-001	EXT CARD: RF RCVR
	601-2274-001	ROCKWELL COLLINS		ASI-35-8B	EXTENDER CARD: 331D-7 HSI, A6
	601-2275-001	ROCKWELL COLLINS		ASI-35-8C	EXTENDER CARD: 331D-7 HSI, A4
	601-2276-001	ROCKWELL COLLINS		ASI-35-8D	EXTENDER CARD: 331D-7 HSI, A3
	601-2277-001	ROCKWELL COLLINS		ASI-35-8E	EXTENDER CARD: 331D-7 HSI, A5
	601-4759-001	ROCKWELL COLLINS		ASI-4759-001	EXTENDER CARD: 913K-1A/2H REAR
	6041-3782-200	AEROFLEX (IFR)		ASI-6041-3782-200	CABLE: IFR STD-7000 TO CRT INTERFACE ASSY
	6041-3782-300	AEROFLEX (IFR)		ASI-6041-3782-300	CABLE: IFR CRT INTERFACE ASSY (7005-3742-400) TO MONITOR
	6046-3880-600	AEROFLEX (IFR)		ASI-6046-3880-600	CABLE: IFR DF-7708 TO STD-7000
	6046-3880-700	AEROFLEX (IFR)		ASI-6046-3880-700	CABLE: IFR DF-7708 TO COLLINS RADAR ANTENNA
	6046-3880-800	AEROFLEX (IFR)		ASI-6046-3880-800	CABLE: IFR DF-7708 TO COLLINS RADAR CONTROL
	6046-3880-900	AEROFLEX (IFR)		ASI-6046-3880-900	CABLE: IFR DF-7708 TO COLLINS RADAR INDICATOR
	6046-3881-000	AEROFLEX (IFR)		ASI-6046-3881-000	CABLE: IFR DF-7708 TO COLLINS RADAR R/T
	6046-3881-500	AEROFLEX (IFR)		ASI-6046-3881-500	CABLE: IFR DF-7708 TO COLLINS CONTROL (ADAPTER)
	60-4984-1	HONEYWELL (GRIMES)		ASI-60-4984-1	CABLE: 60-4983-3 / -5 STROBE POWER SUPPLY TO TEST LIGHT
	608-3617-001	ROCKWELL COLLINS		ASI-213-1	SERVO LOOP TEST SET FOR 334C-6 / SVO-80
	608-3945-001	ROCKWELL COLLINS	01-0431-00	ASI-21-3C	SERVO MOUNT HOLDING FIXTURE (EXCEPT 351B-6J/K/L/M)
	608-4005-001	ROCKWELL COLLINS		ASI-21-3D	ADAPTER HUB
	608-4006-001	ROCKWELL COLLINS		ASI-21-3E	SPANNER WRENCH
	608-4699-001	ROCKWELL COLLINS		ASI-21-3F	BACKLASH TESTER (25-241J DIAL INDICATOR REQUIRED BUT NOT INCLUDED)
	608-9941-001	ROCKWELL COLLINS		ASI-20-82A	CABLE: ASI-208 (980H-5) POWER CABLE
	609-1429-001	ROCKWELL COLLINS		ASI-1429-001	EXT CABLE ASSY FOR 671U-4() RF MODULE
	609-1438-001	ROCKWELL COLLINS		ASI-1438-001	EXT CABLE ASSY FOR 671U-4() PWR SUPPLY
	609-9433-001	ROCKWELL COLLINS		ASI-20-84A	CABLE: ASI-208-4 (878L-40) W1 CABLE
	609-9487-001	ROCKWELL COLLINS		ASI-20-84C	CABLE: ASI-208-4 (878L-40) W3 CABLE

OEM TO ASI EQUIVALENT CROSS REFERENCE

EQUIV MN	EQUIV PN	EQUIV OEM	JC-AIR PN	ASI MN	DESCRIPTION
	609-9498-001	ROCKWELL COLLINS		ASI-208-3-1	EXTENDER FIXTURE, CARD (P/O ASI-208-3)
	609-9549-001	ROCKWELL COLLINS		ASI-20-84B	CABLE: ASI-208-4 (878L-40) W2 CABLE
	617-6769-001	ROCKWELL COLLINS		ASI-6769-001	ADAPTER CABLE: 973L-1/635U
	617-9736-001	ROCKWELL COLLINS		ASI-208-2	POWER PANEL
	617-9743-001	ROCKWELL COLLINS	01-0524-00	ASI-20-7F	CABLE: DC SUPPLY TO J35
	617-9755-001	ROCKWELL COLLINS	55-0361-00	ASI-20-7C	CABLE: ASI-207-2 (678P-5) J2 TO 618T-() P40
	617-9756-001	ROCKWELL COLLINS	55-0361-03	ASI-20-7A	CABLE: ASI-207-2 (678P-5) J4 TO 490S-1 J1
	617-9758-001	ROCKWELL COLLINS	55-0361-00	ASI-20-7B	CABLE: ASI-207-2 (678P-5) J3 TO 490S-1 J3
	617-9770-001	ROCKWELL COLLINS	55-0361-02	ASI-20-83A	CABLE: ASI-208-3 (878L-39) W1 CABLE
	618-1673-002	ROCKWELL COLLINS		ASI-299-2	ALT-50A/55B/860F-2 TRANSMITTER DUST COVER FIXTURE
	618-3758-001	ROCKWELL COLLINS		ASI-3758-001	EXTENDER CARD: 913K-1 FRONT
	618-3759-001	ROCKWELL COLLINS		ASI-3759-001	EXTENDER CARD: 913K-1 REAR
	618-7711-001	ROCKWELL COLLINS		ASI-20-7D	CABLE: 618T-() TO WATTMETER
	618-7712-001	ROCKWELL COLLINS	55-0361-05	ASI-20-7E	CABLE: 490S-1 J2 TO WATTMETER
	618-8938-001	ROCKWELL COLLINS	55-0361-05	ASI-8938-001	EXTENDER BOARD FOR 972V-1
	621-2235-001	ROCKWELL COLLINS		ASI-2235-001	MAINTENANCE KIT FOR 860E-4/5
	621-2235-002	ROCKWELL COLLINS		ASI-2235-002	860E-4/5 EXTENDER CABLE KIT
	621-2244-001	ROCKWELL COLLINS		ASI-2244-001A	CABLE: RF NO.1 (P/O ASI-2235-001/-002)
	621-2245-001	ROCKWELL COLLINS		ASI-2245-001	CABLE: RF NO.2 (P/O ASI-2235-001/-002)
	621-2248-001	ROCKWELL COLLINS		ASI-2248-001	CABLE: ATE (P/O ASI-2235-001)
	621-2248-002	ROCKWELL COLLINS		ASI-2248-002	CABLE: ATE (P/O ASI-2235-002)
	621-3517-001	ROCKWELL COLLINS		ASI-34-5A	CABLE: ASI-345 (578F-1) TO 334C-3
	621-8132-001	ROCKWELL COLLINS		ASI-22-4B	CABLE: ASI-224 (972V-1) RT / W2
	621-8133-001	ROCKWELL COLLINS		ASI-22-4C	CABLE: ASI-224 (972V-1) ADAPTER / W3
	621-8134-001	ROCKWELL COLLINS		ASI-22-4A	CABLE: ASI-224 (972V-1) CONTROL / W1
	621-8135-002	ROCKWELL COLLINS		ASI-22-4E	CABLE: ASI-224 (972V-1) RT AGE / W5
	621-8143-001	ROCKWELL COLLINS		ASI-22-4F	CABLE: ASI-224 (972V-1) POWER / W6
	621-8144-001	ROCKWELL COLLINS		ASI-22-4G	CABLE: ASI-224 (972V-1) INTERNAL HIS / W7
	621-8164-001	ROCKWELL COLLINS		ASI-22-4D	CABLE: ASI-224 (972V-1) SPECIAL INTERFACE / W4
	621-9185-001	ROCKWELL COLLINS		ASI-246-1	CAPSTAN TEST FIXTURE FOR 334C-9/9A/11
	621-9185-002	ROCKWELL COLLINS		ASI-246-2	CAPSTAN TEST FIXTURE FOR SVO-65() AND SVO-75
	622-1678-004	ROCKWELL COLLINS		ASI-225	TACAN TEST SET ADAPTER (972V-1 TO 899L-1)
	622-2182-001	ROCKWELL COLLINS		ASI-789-3	TEST ADAPTER: AN/ARM-102 OR ASI-789 TO DF-301E
	622-2752-001	ROCKWELL COLLINS		ASI-2752-159	ARC-159 CABLE SET
	622-4055-002	ROCKWELL COLLINS		ASI-203-A1	RATE GENERATOR CARD FOR ASI-203 / 980N-1 / 522-4610-004
	622-6454-002	ROCKWELL COLLINS		ASI-18-9A	14 TOOTH HUB (FOR SVO-65() AND SVO-75)
	626-4247-001	ROCKWELL COLLINS		ASI-269-5B	SCAN SECTOR GEAR PULLER
	628-5151-001	ROCKWELL COLLINS		ASI-21-3B	351B-6J/K/L/M SERVO MOUNT HOLDING FIXTURE
	628-5274-001	ROCKWELL COLLINS		ASI-70-04Q1	VHF-700 ADJUSTMENT FIXTURE
	628-6301-102	ROCKWELL COLLINS		ASI-6301-002	PROM BOARD
	628-8209-001	ROCKWELL COLLINS		ASI-70-02H	ILS-700 LOADING TOOL
	628-8351-001	ROCKWELL COLLINS		ASI-70-04Q2	VHF-700 ADJUSTMENT FIXTURE
	628-8364-001	ROCKWELL COLLINS		ASI-715-2	TEST COVER (ILS-700 MAN FIG 907)
	628-8442-001	ROCKWELL COLLINS		ASI-33-83G	CABLE: AAC-200P (CIRCULAR CONNECTOR PER CTS-202 SIL 1-86)
	628-8518-001	ROCKWELL COLLINS		ASI-33-83H	CABLE: PAC-200/230 TO CTS-200/202 ADAPTER CABLE
	628-8519-001	ROCKWELL COLLINS		ASI-33-83J	PAC 200/230 ANTENNA SIMULATOR (DUMMY LOAD)
	628-8522-001	ROCKWELL COLLINS		ASI-33-83K	PAC 200/230 TEST CRADLE
	628-8526-001 (1)	ROCKWELL COLLINS		ASI-33-84B	PAC 200/230 IN CIRCUIT TEST CABLE
	628-8526-001 (2)	ROCKWELL COLLINS		ASI-33-84C	PAC 200/230 OUT OF CIRCUIT TEST CABLE
	628-8554-001	ROCKWELL COLLINS		ASI-338-7	DSA-220 TEST SET
	628-8557-001	ROCKWELL COLLINS		ASI-338-8	LWA-200 LONG WIRE ADAPTER TEST SET
	628-8735-001	ROCKWELL COLLINS		ASI-379	WXP TEST FIXTURE
	628-8752-001	ROCKWELL COLLINS		ASI-94-0A	CABLE: ASI-CTS-940 TO TDR-94/94D
	628-8752-001	ROCKWELL COLLINS		ASI-94-0A1	CABLE: ASI-CTS-940 TO TDR-94/94D (9 FEET)
	628-8753-001	ROCKWELL COLLINS		ASI-94-0B	CABLE: ASI-CTS-940 TO ARINC CARD
	628-8754-001	ROCKWELL COLLINS		ASI-94-0C	CABLE: ASI-CTS-940 TO CONTEC I/O CARD
	628-8839-001	ROCKWELL COLLINS		ASI-251	CTS-859 TERMINAL TO IBM SWITCH UNIT (ALT PN 685-6295-001)
	628-8847-001	ROCKWELL COLLINS		ASI-84-1A	CABLE: ASI-CTS-841 TO DSP
	628-8847-002	ROCKWELL COLLINS		ASI-84-1B	CABLE: ASI-CTS-841 TO POWER SUPPLY
	628-8847-003	ROCKWELL COLLINS		ASI-84-1C	CABLE: ASI-CTS-841 TO RF CABLE
	628-8847-004	ROCKWELL COLLINS		ASI-84-1D	CABLE: ASI-CTS-841 TO RF BASE
	628-8847-005	ROCKWELL COLLINS		ASI-84-1E	CABLE: ASI-CTS-841 TO INDICATOR
	628-8847-006	ROCKWELL COLLINS		ASI-84-1F	CABLE: ASI-CTS-841 TO TERMINAL
	628-8847-007	ROCKWELL COLLINS		ASI-84-1G	CABLE: ASI-CTS-841 TO MODULATOR
	628-8847-008	ROCKWELL COLLINS		ASI-84-1H	CABLE: ASI-CTS-841 TO DIGITAL ATTITUDE SOURCE
	628-8847-009	ROCKWELL COLLINS		ASI-84-1J	CABLE: ASI-CTS-841 TO WXP-850
	628-8847-010	ROCKWELL COLLINS		ASI-84-1K	CABLE: ASI-CTS-841 TO IMPATT
	628-8847-011	ROCKWELL COLLINS		ASI-84-1L	CABLE: ASI-CTS-841 TO RF CABLE
	628-8847-012	ROCKWELL COLLINS		ASI-84-1M	CABLE: ASI-CTS-841 TO TRF BASE
	628-8847-013	ROCKWELL COLLINS		ASI-84-1N	CABLE: ASI-CTS-841 TO RF CABLE
	628-8847-014	ROCKWELL COLLINS		ASI-84-1P	CABLE: ASI-CTS-841 TO RF BASE
	628-8847-015	ROCKWELL COLLINS		ASI-84-1Q	CABLE: ASI-CTS-841 TO POWER SUPPLY
	628-8888-001	ROCKWELL COLLINS		ASI-40-3F	CABLE: ASI-403 (972S-5) TO SVO-85B(-003)
	628-8904-001	ROCKWELL COLLINS		ASI-8904-001	CABLE: ECU-3000
	629-0001-001	ROCKWELL COLLINS		ASI-18-3A	CABLE: ASI-183 (971F-1) GYRO SIM CABLE
	629-0002-001	ROCKWELL COLLINS	55-0243-01	ASI-18-3B	CABLE: ASI-183 (971F-1) TO 562C-5()
	629-0005-001	ROCKWELL COLLINS	55-0243-02	ASI-18-3C	CABLE: ASI-183 (971F-1) TO 161E-2A
	629-0006-001	ROCKWELL COLLINS	55-0243-05	ASI-18-3D	CABLE: ASI-183 (971F-1) TO 614E-5A
	629-0007-001	ROCKWELL COLLINS	55-0243-06	ASI-18-3E	CABLE: ASI-183 (971F-1) TO 562C-5()
	629-0009-001	ROCKWELL COLLINS	55-0243-07	ASI-18-3F	CABLE: ASI-183 (971F-1) TO 562C-8
	629-0010-001	ROCKWELL COLLINS	55-0243-09	ASI-18-3G	CABLE: ASI-183 (971F-1) TO 562C-5()
	629-0102-001	ROCKWELL COLLINS		ASI-31-3A	CABLE: ASI-313 (MX-9626/ARM) RF CABLE
	629-0303-001	ROCKWELL COLLINS		ASI-0303-001	CABLE: PWR SUPPLY / PWR AMP (P/O ASI-2752-159)
	629-0304-001	ROCKWELL COLLINS		ASI-0304-001	CABLE: SW UNIT (P/O ASI-2752-159)
	629-0312-001	ROCKWELL COLLINS		ASI-0312-001	CABLE: FREQ / SYNTH (P/O ASI-2752-159)

OEM TO ASI EQUIVALENT CROSS REFERENCE

EQUIV MN	EQUIV PN	EQUIV OEM	JC-AIR PN	ASI MN	DESCRIPTION
	629-0317-001	ROCKWELL COLLINS		ASI-0317-001	CABLE: XLTR / MOD (P/O ASI-2752-159)
	629-0389-001	ROCKWELL COLLINS	55-0243-10	ASI-30-8A	CABLE: ASI-308-1/-2 (AN/ARM-165/-165A) W1
	629-0390-001	ROCKWELL COLLINS		ASI-30-8B	CABLE: ASI-308-1/-2 (AN/ARM-165/-165A) W2
	629-0391-001	ROCKWELL COLLINS		ASI-30-8C	CABLE: ASI-308-1/-2 (AN/ARM-165/-165A) W3
	629-0392-001	ROCKWELL COLLINS		ASI-30-8D	CABLE: ASI-308-1/-2 (AN/ARM-165/-165A) W4
	629-0428-001	ROCKWELL COLLINS		ASI-0428-001	CABLE: GUARD REC (P/O ASI-2752-159)
	629-0433-001	ROCKWELL COLLINS		ASI-0433-001	CABLE: IF/AF AMP (P/O ASI-2752-159)
	629-2703-001	ROCKWELL COLLINS		ASI-128	NAV TEST PANEL FOR VIR-32, VIR-33, VIR-432, VIR-433
	629-4851-001	ROCKWELL COLLINS		ASI-29-6E	CABLE: ASI-296 (971T-1) RED PROBE
	629-4851-002	ROCKWELL COLLINS		ASI-29-6F	CABLE: ASI-269 (971T-1) BLK PROBE
	629-4851-003	ROCKWELL COLLINS		ASI-29-6G	CABLE: ASI-269 (971T-1) GRN PROBE
	629-4886-001	ROCKWELL COLLINS		ASI-29-6C	CABLE: ASI-296 (971T-1) 115 VAC 400 HZ PWR
	629-4898-001	ROCKWELL COLLINS		ASI-29-6A	CABLE: ASI-296 (971T-1) TO FPC-75(BP/TP)
	629-4899-001	ROCKWELL COLLINS		ASI-29-6B	CABLE: ASI-296 (971T-1) TO FPC-75(ATE)
	629-4920-001	ROCKWELL COLLINS		ASI-4920-001	EXTENDER CARD FOR FPC-75 A4 (P/O ASI-9046-001 KIT)
	629-4920-001	ROCKWELL COLLINS		ASI-4928-001	EXTENDER CARD FOR FPC-75 A5 (P/O ASI-9046-001 KIT)
	629-4920-001	ROCKWELL COLLINS		ASI-4925-001	EXTENDER CARD FOR FPC-75 A6 (P/O ASI-9046-001 KIT)
	629-6948-001	ROCKWELL COLLINS		ASI-715-1	ILS-700 A1 TUNING COVER
	629-8139-001	ROCKWELL COLLINS		ASI-8139-001	CABLE: APA-80 EXTENDER (38 POS-NOTCHED)
	629-8139-002	ROCKWELL COLLINS		ASI-8139-002	CABLE: APA-80 EXTENDER (30 POS)
	629-8139-003	ROCKWELL COLLINS		ASI-8139-003	CABLE: APA-80 EXTENDER (38 POS)
	629-8140-001	ROCKWELL COLLINS		ASI-8140-001	CABLE: FGC-80 A2J7 EXTENDER
	629-8140-002	ROCKWELL COLLINS		ASI-8140-002	CABLE: FGC-80 A2J6 EXTENDER
	629-8140-003	ROCKWELL COLLINS		ASI-8140-003	CABLE: FGC-80 A3J9 EXTENDER
	629-8140-004	ROCKWELL COLLINS		ASI-8140-004	CABLE: FGC-80 A3J8 EXTENDER
	629-8140-005	ROCKWELL COLLINS		ASI-8140-005	CABLE: FGC-80 A4J11 EXTENDER
	629-8140-006	ROCKWELL COLLINS		ASI-8140-006	CABLE: FGC-80 A4J10 EXTENDER
	629-8140-007	ROCKWELL COLLINS		ASI-8140-007	CABLE: FGC-80 A5J13 EXTENDER
	629-8140-008	ROCKWELL COLLINS		ASI-8140-008	CABLE: FGC-80 A5J12 EXTENDER
	629-8140-009	ROCKWELL COLLINS		ASI-8140-009	CABLE: FGC-80 A6J15 EXTENDER
	629-8140-010	ROCKWELL COLLINS		ASI-8140-010	CABLE: FGC-80 A6J14 EXTENDER
	629-8140-011	ROCKWELL COLLINS		ASI-8140-011	CABLE: FGC-80 A7J17 EXTENDER
	629-8140-012	ROCKWELL COLLINS		ASI-8140-012	CABLE: FGC-80 A7J16 EXTENDER
	629-9007-001	ROCKWELL COLLINS		ASI-18-3H	CABLE: ASI-183 (971F-1) TO 562C-8F/G
	629-9008-001	ROCKWELL COLLINS	55-0243-11	ASI-18-3I	CABLE: ASI-183 (971F-1) TO 562C-8F
	629-9046-001	ROCKWELL COLLINS		ASI-9046-001	EXTENDER CARD SET FOR FPC-75 (INCLUDES A4, A5, AND A6 EXTENDERS)
	629-9063-001	ROCKWELL COLLINS	55-0243-12	ASI-30-8E	CABLE: ASI-308-1/-2 (AN/ARM-165/-165A) W5
	629-9064-001	ROCKWELL COLLINS		ASI-30-8F	CABLE: ASI-308-1/-2 (AN/ARM-165/-165A) W6
	629-9065-001	ROCKWELL COLLINS		ASI-30-8G	CABLE: ASI-308-1/-2 (AN/ARM-165/-165A) W7
	629-9067-001	ROCKWELL COLLINS		ASI-30-8H	CABLE: ASI-308-1/-2 (AN/ARM-165/-165A) W8
	629-9068-001	ROCKWELL COLLINS		ASI-30-8J	CABLE: ASI-308-1/-2 (AN/ARM-165/-165A) W9
	629-9161-001	ROCKWELL COLLINS		ASI-31-0A	CABLE: ASI-310 (438K-2) W1
	629-9162-001	ROCKWELL COLLINS		ASI-31-0B	CABLE: ASI-310 (438K-2) W2
	629-9163-001	ROCKWELL COLLINS		ASI-31-0C	CABLE: ASI-310 (438K-2) W3
	629-9164-001	ROCKWELL COLLINS		ASI-31-0D	CABLE: ASI-310 (438K-2) W4
	629-9165-001	ROCKWELL COLLINS		ASI-31-0E	CABLE: ASI-310 (438K-2) W5
	629-9167-001	ROCKWELL COLLINS		ASI-31-0F	CABLE: ASI-310 (438K-2) W7
	629-9202-001	ROCKWELL COLLINS		ASI-9202-001	CABLE: 972V-1 TO 331A-8H INDICATOR (8 IN)
	629-9202-002	ROCKWELL COLLINS		ASI-9202-002	CABLE: 972V-1 TO 331A-8H INDICATOR (48 IN) / SEE ASI-22-6A FOR ALT
	629-9305-001	ROCKWELL COLLINS		ASI-9305-118	TCN-118 MAINTENANCE KIT
	629-9496-001	ROCKWELL COLLINS		ASI-9496-001	CABLE: FRONT PNL EXTENDER (P/O ASI-2752-159)
	629-9497-001	ROCKWELL COLLINS		ASI-9497-001	CABLE: SIGNAL COND EXTENDER (P/O ASI-2752-159)
	629-9498-001	ROCKWELL COLLINS		ASI-9498-001	CABLE: MAND CONT EXTENDER (P/O ASI-2752-159)
	629-9499-001	ROCKWELL COLLINS		ASI-9499-001	CABLE: MEMORY CARD EXTENDER (P/O ASI-2752-159)
	629-9509-001	ROCKWELL COLLINS		ASI-9509-001	CABLE: BACK PLATE ASSY EXTENDER (P/O ASI-2752-159)
	629-9515-001	ROCKWELL COLLINS		ASI-30-8K	CABLE: ASI-308-1/-2 (AN/ARM-165/-165A) W11
	629-9555-001	ROCKWELL COLLINS		ASI-9555-001	CABLE: EXTENDER (P/O ASI-2752-159)
	629-9556-001	ROCKWELL COLLINS		ASI-9556-001	CABLE: EXTENDER (P/O ASI-2752-159)
	629-9557-001	ROCKWELL COLLINS		ASI-18-5B	CABLE: ASI-185 (970G-1) TO RMI-36
	629-9558-001	ROCKWELL COLLINS	55-0583-01	ASI-18-5A	CABLE: ASI-185 (970G-1) TO 332C-10
	629-9581-001	ROCKWELL COLLINS		ASI-9581-001	CABLE: EXTENDER (P/O ASI-2752-159)
	629-9871-001	ROCKWELL COLLINS	55-0583-00	ASI-9871-001	DISPLAY FILTER FOR COLLINS 478A-3 ZIFOR III
	629-9929-001	ROCKWELL COLLINS	55-0377-00	ASI-28-8A	CABLE: ASI-288 (968A-1) TO FMC-28/28A J1
	629-9929-002	ROCKWELL COLLINS		ASI-28-8B	CABLE: ASI-288 (968A-1) TO FMC-28/28A J2
	629-9935-001	ROCKWELL COLLINS	55-0377-01	ASI-28-8C	EXTENDER CARD: FMC-28/28A (P6-J6)
	629-9935-002	ROCKWELL COLLINS	55-0377-02	ASI-28-8D	EXTENDER CARD: FMC-28/28A (P7-J7)
	634-0549-001	ROCKWELL COLLINS	55-0377-03	ASI-247	YAW DAMPER TEST FIXTURE
	634-1229-001	ROCKWELL COLLINS	01-0552-00	ASI-1229-001	CABLE ASSY
	634-1305-001	ROCKWELL COLLINS		ASI-1305-001	CABLE ASSY
	634-1708-001	ROCKWELL COLLINS		ASI-393-5	EFD-85 BEZEL ADAPTER (EFD-85 MAN FIG 903)
	634-1708-002	ROCKWELL COLLINS		ASI-393-6	EFD-85 BEZEL ADAPTER (EFD-85 MAN FIG 904)
	634-1708-003	ROCKWELL COLLINS		ASI-393-2	MDF-85() BEZEL ADAPTER (MFD-85 MAN FIG 902)
	634-1708-010	ROCKWELL COLLINS		ASI-393-9	EFD-84 BEZEL ADAPTER TEMPLATE
	634-1708-011	ROCKWELL COLLINS		ASI-393-10	EFD-84 BEZEL ADAPTER TEMPLATE
	634-1723-001	ROCKWELL COLLINS		ASI-21-24C	CAPSTAN ADJUSTWRENCH (SUPPLIED WITH ASI-21-24A AND ASI-21-24B)
	634-1728-001	ROCKWELL COLLINS		ASI-40-31C	MOUNT CLUTCH DEPTH GUIDE (MISLABELED AS 622-1728-001)
	634-1729-001	ROCKWELL COLLINS		ASI-40-31B	SERVO CLUTCH DEPTH GAUGE (MISLABELED AS 622-1729-001)
	634-1772-001	ROCKWELL COLLINS		ASI-40-31D	SVO-85/1000 BACKLASH TEST FIXTURE (REQ USER SUPPLIED 25-241J)
	634-1772-002	ROCKWELL COLLINS		ASI-40-31D1	SVO-85/1000 BACKLASH TEST FIXTURE (INCLUDES 25-241J)
	634-1773-001	ROCKWELL COLLINS		ASI-21-24A	CAPSTAN TORQUE ADJUSTMENT FIXTURE (INCLUDED WITH ASI-212-4)
	634-1773-002	ROCKWELL COLLINS		ASI-21-24B	CAPSTAN TORQUE ADJUSTMENT FIXTURE
	634-1785-001	ROCKWELL COLLINS		ASI-34-82F	TSM-1000 CAPSTAN LOCKING FIXTURE
	634-1942-001	ROCKWELL COLLINS		ASI-34-82D	TSM-1001 CAPSTAN LOCKING FIXTURE
	634-1943-001	ROCKWELL COLLINS		ASI-34-82E	SMT-1001 CAPSTAN LOCKING FIXTURE
	634-2224-001	ROCKWELL COLLINS		ASI-2224-001	ALI-80/MSI-80/YSI-80 EXTENDER NO. 4

OEM TO ASI EQUIVALENT CROSS REFERENCE

EQUIV MN	EQUIV PN	EQUIV OEM	JC-AIR PN	ASI MN	DESCRIPTION
	634-2226-001	ROCKWELL COLLINS		ASI-40-3B	CABLE: ASI-403 TO SVO-85A(-001/101)/-85B(-001/101)/-85C(-003/103)
	634-2226-002	ROCKWELL COLLINS		ASI-40-3C	CABLE: ASI-403 TO SVO-85A(-002/102)/-85B(-002/102)/-85C(-004/104)
	634-2226-003	ROCKWELL COLLINS		ASI-40-3D	CABLE: ASI-403 (972S-5) TO SVO-3000
	634-2714-001	ROCKWELL COLLINS		ASI-18-3L	CABLE: ASI-183 (971F-1) TO 562C-8G
	634-2830-001	ROCKWELL COLLINS	55-0243-15	ASI-18-9C	SMT-65E CAPSTAN HOLDING FIXTURE
	634-2835-001	ROCKWELL COLLINS		ASI-18-9B	SMT-65() CAPSTAN HOLDING FIXTURE
	634-3060-001	ROCKWELL COLLINS		ASI-34-4A	CABLE: ASI-344 TO DAU-850/CTS-2000
	634-3140-001	ROCKWELL COLLINS		ASI-187-PS1	POWER SUPPLY FOR ASI-187/970E-1
	634-3381-001	ROCKWELL COLLINS		ASI-41-2A	CABLE: ASI-412 (CTS-64) P1
	634-3474-001	ROCKWELL COLLINS		ASI-41-2B	CABLE: ASI-412 (CTS-64) P2
	634-3476-001	ROCKWELL COLLINS		ASI-41-2D	CABLE: ASI-412 (CTS-64) P4
	634-3477-001	ROCKWELL COLLINS		ASI-41-2E	CABLE: ASI-412 (CTS-64) P5
	634-3478-001	ROCKWELL COLLINS		ASI-41-2F	CABLE: ASI-412 (CTS-64) P6
	634-3480-001	ROCKWELL COLLINS		ASI-41-2G	CABLE: ASI-412 (CTS-64) P7
	634-3482-001	ROCKWELL COLLINS		ASI-41-2H	CABLE: ASI-412 (CTS-64) P9
	634-3483-001	ROCKWELL COLLINS		ASI-41-2J	CABLE: ASI-412 (CTS-64) J1
	634-3819-001	ROCKWELL COLLINS		ASI-393-3	EFD-85 CRT LINEARITY GAGE (EFD-85 MAN FIG 901)
	634-3820-001	ROCKWELL COLLINS		ASI-393-4	EFD-85 CRT LINEARITY GAGE (EFD-85 MAN FIG 902)
	634-4242-001	ROCKWELL COLLINS		ASI-40-3A	CABLE: ASI-403 (972S-5) TO SVO-75
	634-7452-001	ROCKWELL COLLINS		ASI-41-2C	CABLE: ASI-412 (CTS-64) EMULATOR
	634-9003-001	ROCKWELL COLLINS		ASI-12-1A	CABLE: ASI-CTS-12 (CTS-12) TO HSI-85()
	634-9004-001	ROCKWELL COLLINS		ASI-12-1B	CABLE: ASI-CTS-12 (CTS-12) TO COLT CTS-703
	634-9021-001	ROCKWELL COLLINS		ASI-33-83E	TEST FIXTURE
	634-9022-001	ROCKWELL COLLINS		ASI-33-83F	DISCRIMINATOR ALIGNMENT BOX
	634-9023-001	ROCKWELL COLLINS		ASI-9023-001	CABLE: POWER SUPPLY (P/O ASI-9305-118)
	634-9024-001	ROCKWELL COLLINS		ASI-9024-001	CABLE: RECEIVER (P/O ASI-9305-118)
	634-9025-001	ROCKWELL COLLINS		ASI-9025-001	CABLE: SYNTH DRIVER (P/O ASI-9305-118)
	634-9030-001	ROCKWELL COLLINS		ASI-9030-001	CABLE: RF (P/O ASI-9305-118)
	634-9031-001	ROCKWELL COLLINS		ASI-9031-001	CABLE: RF (P/O ASI-9305-118)
	634-9033-001	ROCKWELL COLLINS		ASI-9033-001	CABLE: RF (P/O ASI-9305-118)
	634-9035-001	ROCKWELL COLLINS		ASI-9035-001	CABLE: W4
	634-9036-001	ROCKWELL COLLINS		ASI-9036-001	CABLE: W5
	634-9037-001	ROCKWELL COLLINS		ASI-9037-001	CABLE: W2
	634-9038-001	ROCKWELL COLLINS		ASI-9038-001	CABLE: W1
	634-9039-001	ROCKWELL COLLINS		ASI-9039-001	CABLE: W3
	634-9299-001	ROCKWELL COLLINS		ASI-18-3J	CABLE: ASI-183 (971F-1) TO 562C-8F
	634-9424-001	ROCKWELL COLLINS	55-0243-13	ASI-29-1A	CABLE: ASI-291 (968J-1) TO COLLINS 622-4149-001
	634-9425-001	ROCKWELL COLLINS		ASI-29-1B	CABLE: ASI-291 (968J-1) TO COLLINS 622-4149-001
	634-9480-001	ROCKWELL COLLINS		ASI-33-81E	CABLE: CTL-201/201A/220
	634-9539-001	ROCKWELL COLLINS		ASI-9539-001	CABLE: MEMORY
	634-9540-001	ROCKWELL COLLINS		ASI-9540-001	CABLE: CONTROL
	634-9541-001	ROCKWELL COLLINS		ASI-9541-001	CABLE: PA
	634-9542-001	ROCKWELL COLLINS		ASI-9542-001	CABLE: ALC NO. 1
	634-9543-001	ROCKWELL COLLINS		ASI-9543-001	CABLE: ALC NO. 2
	634-9647-001	ROCKWELL COLLINS		ASI-28-6A	CABLE: FGC-80 UNIT
	634-9648-001	ROCKWELL COLLINS		ASI-28-6B	CABLE: FGC-80 AIRCRAFT
	634-9649-001	ROCKWELL COLLINS		ASI-28-6C	CABLE: APC-80 UNIT
	634-9650-001	ROCKWELL COLLINS		ASI-28-6D	CABLE: APC-80 AIRCRAFT
	634-9651-001	ROCKWELL COLLINS		ASI-28-6E	CABLE: APA-80 UNIT
	634-9652-001	ROCKWELL COLLINS		ASI-28-6F	CABLE: APA-80 AIRCRAFT
	634-9653-001	ROCKWELL COLLINS		ASI-28-6G	CABLE: 562A-5M5 UNIT
	634-9654-001	ROCKWELL COLLINS		ASI-28-6H	CABLE: 562A-5M5 AIRCRAFT
	634-9655-001	ROCKWELL COLLINS		ASI-28-6I	CABLE: 562C-5 UNIT
	634-9656-001	ROCKWELL COLLINS		ASI-28-6J	CABLE: 562C-5 AIRCRAFT
	634-9668-001	ROCKWELL COLLINS		ASI-18-3K	CABLE: ASI-183 (971F-1) TO 562C-8()
	634-9759-001	ROCKWELL COLLINS	55-0243-14	ASI-9759-001	EXT CARD: SMO
	634-9802-001	ROCKWELL COLLINS		ASI-11-1A	CABLE: ASI-CTS-11 (CTS-11) TO ADI-85
	634-9812-001	ROCKWELL COLLINS		ASI-35-8A	CABLE: ASI-358 (969Y-1) TO 331D-7
	634-9848-001	ROCKWELL COLLINS		ASI-Y-1	HF Y-ADAPTER UNIT
	634-9945-001	ROCKWELL COLLINS		ASI-9945-001	EXTENDER CARD FOR HIS-85 A5 (P/O ASI-9999-001 EXTENDER KIT)
	634-9977-001	ROCKWELL COLLINS		ASI-9977-001	EXTENDER CARD FOR ADI-85 (P/O ASI-9999-001 EXTENDER KIT)
	634-9994-001	ROCKWELL COLLINS		ASI-33-85C	CABLE: ASI-338-5 CTS-204) W3
	634-9995-001	ROCKWELL COLLINS		ASI-33-85A	CABLE: ASI-338-5 CTS-204) W1
	634-9996-001	ROCKWELL COLLINS		ASI-33-85B	CABLE: ASI-338-5 CTS-204) W2
	634-9999-001	ROCKWELL COLLINS		ASI-9999-001	ADI-85() AND HSI-85() EXTENDER KIT
	635-3127-001	ROCKWELL COLLINS		ASI-188-1	RADAR TEST PANEL FOR WXR-150/200/220/250/270/300/350
	635-5687-001	ROCKWELL COLLINS		ASI-5687-001	CABLE: RCVR (P/O ASI-2235-001/-002)
	635-5688-001	ROCKWELL COLLINS		ASI-5688-001	CABLE: PWR AMP (P/O ASI-2235-001/-002)
	635-5689-001	ROCKWELL COLLINS		ASI-5689-001	CABLE: DRVR (P/O ASI-2235-001/-002)
	635-5774-001	ROCKWELL COLLINS	55-0105-01	ASI-18-2B	CABLE: ASI-182 (975D-2) TO ARINC 568 DME
	635-5775-001	ROCKWELL COLLINS		ASI-18-2A	CABLE: ASI-182 (975D-2) TO ARINC 521 DME
	635-5791-001	ROCKWELL COLLINS	55-0105-00	ASI-18-2C	CABLE: ASI-182 (975D-2) TO SQUAWK NAUT
	635-5795-001	ROCKWELL COLLINS	55-0105-02	ASI-18-2D	CABLE: ASI-182 (975D-2) TO DME 40
	635-6254-001	ROCKWELL COLLINS	55-0105-03	ASI-239	SPECIAL COAXIAL WRENCH
	635-6382-001	ROCKWELL COLLINS		ASI-209-6	HARNESS TEST SET
	637-0789-001	ROCKWELL COLLINS		ASI-213-2	334C-6 / SVO-80 MINIMUM PERFORMANCE TEST SET
	637-1902-001	ROCKWELL COLLINS		ASI-32-8A	490T-() A1 EXTENDER
	637-1904-001	ROCKWELL COLLINS		ASI-32-8B	490T-() A3 EXTENDER
	637-1964-001	ROCKWELL COLLINS		ASI-32-83B	DISCRIMINATOR TESTER ADAPTER FOR 548S-()
	637-7656-001	ROCKWELL COLLINS		ASI-158	UNIVERSAL HIGH POT TESTER
	638-0161-002	ROCKWELL COLLINS		ASI-CTS-961	LOW CURRENT POWER CONTROL PANEL
	638-0199-001	ROCKWELL COLLINS		ASI-402	CTC-429 TEST ADAPTER
	638-0239-001	ROCKWELL COLLINS		ASI-354	AHC-85 DUAL MULTI-SENSOR TEST PANEL
	638-0246-001	ROCKWELL COLLINS		ASI-35-4A	CABLE: ASI-354 TO AHC-85
	638-0246-002	ROCKWELL COLLINS		ASI-35-4B	CABLE: ASI-354 TO AHC-85

OEM TO ASI EQUIVALENT CROSS REFERENCE

EQUIV MN	EQUIV PN	EQUIV OEM	JC-AIR PN	ASI MN	DESCRIPTION
	638-0246-003	ROCKWELL COLLINS		ASI-35-4C	CABLE: ASI-354 TO AHC-85-A5
	638-0246-004	ROCKWELL COLLINS		ASI-35-4D	CABLE: ASI-354 TO AHC-85-A6
	638-0246-005	ROCKWELL COLLINS		ASI-35-4E	CABLE: ASI-354 TO COMPUTER
	638-0246-006	ROCKWELL COLLINS		ASI-35-4F	CABLE: ASI-354 TO COMPUTER
	638-0246-007	ROCKWELL COLLINS		ASI-35-4G	CABLE: ASI-354 TO AHC-85
	638-0274-001	ROCKWELL COLLINS		ASI-CTS-960	AHC-85 SYNCHRO SELECT PANEL
	638-0501-001	ROCKWELL COLLINS		ASI-330	SPIN TABLE INTERLOCK
	638-0511-001	ROCKWELL COLLINS		ASI-6358-001	AHC-85 DUAL MULTI-SENSOR TESTER
	638-0524-001	ROCKWELL COLLINS	01-0253-00	ASI-37-3C	CABLE: ASI-373 TO VHF-20/21
	638-0525-002	ROCKWELL COLLINS		ASI-373	VHF-20/21/22/422 TEST PANEL
	638-0716-001	ROCKWELL COLLINS		ASI-35-5A	CABLE: ASI-355 TO VHF-21
	638-0717-001	ROCKWELL COLLINS		ASI-35-5B	CABLE: ASI-355 TO VHF-22
	638-0721-001	ROCKWELL COLLINS		ASI-35-5C	CABLE: ASI-355 TO VHF-422
	638-0722-001	ROCKWELL COLLINS		ASI-355	ANALOG BURN-IN PANEL (VHF-21/22/422)
	638-0723-001	ROCKWELL COLLINS		ASI-35-5D	CABLE: ASI-355 TO VHF-ESS INTERFACE
	638-1226-010	ROCKWELL COLLINS		ASI-1226-010	CABLE: ASI-CTS-974 CHROME INTERFACE
	638-1226-075	ROCKWELL COLLINS		ASI-1226-075	CABLE: ASI-CTS-974 TO FCP-65
	638-1226-076	ROCKWELL COLLINS		ASI-1226-076	CABLE: ASI-CTS-974 TO MAP-65
	638-1226-077	ROCKWELL COLLINS		ASI-1226-077	CABLE: ASI-CTS-974 TO IND-42
	638-1226-078	ROCKWELL COLLINS		ASI-1226-078	CABLE: ASI-CTS-974 TO TCU-906
	638-1226-079	ROCKWELL COLLINS		ASI-1226-079	CABLE: ASI-CTS-974 TO CAD-31/62
	638-1226-080	ROCKWELL COLLINS		ASI-1226-080	CABLE: ASI-CTS-974 TO CAD-870G
	638-1226-081	ROCKWELL COLLINS		ASI-1226-081	CABLE: ASI-CTS-974 TO CAD-870/875 / RAC-870/875
	638-1226-082	ROCKWELL COLLINS		ASI-1226-082	CABLE: ASI-CTS-974 TO RTU-870
	638-1226-083	ROCKWELL COLLINS		ASI-1226-083	CABLE: ASI-CTS-974 TO ASI-80 / MSI-80 / VSI-80
	638-1226-084	ROCKWELL COLLINS		ASI-1226-084	CABLE: ASI-CTS-974 TO PRE-80
	638-1226-085	ROCKWELL COLLINS		ASI-1226-085	CABLE: ASI-CTS-974 TO TAI-80
	638-1226-110	ROCKWELL COLLINS		ASI-1226-085	CABLE: ASI-CTS-974 CHROME DATA
	638-1316-001	ROCKWELL COLLINS		ASI-1316-001	LN2 CHAMBER RACK MOUNT
	638-1381-001	ROCKWELL COLLINS		ASI-CTS-974	FC BURN-IN PANEL
	638-1440-001	ROCKWELL COLLINS		ASI-CTS-973	VHF-2100/4000 HASS PANEL
	638-1461-001	ROCKWELL COLLINS		ASI-CTS-975	POWER CONTROL INTERFACE PANEL
	638-1627-001	ROCKWELL COLLINS		ASI-1627-001	RTA-4XXX WW-MAP LOAD BOX (REPLACED BY ASI-4922-001/964-4922-001)
	638-2221-001	ROCKWELL COLLINS		ASI-2221-001	EXTENDER NO. 1: ADC-80/81/82
	638-2222-001	ROCKWELL COLLINS		ASI-2222-001	EXTENDER NO. 2: ADC-80/81/82
	638-2223-001	ROCKWELL COLLINS		ASI-2223-001	EXTENDER NO. 3: PRE-80
	638-2225-001	ROCKWELL COLLINS		ASI-2225-001	EXTENDER NO. 5: ALI-80/MSI-80/VSI-80
	638-2226-001	ROCKWELL COLLINS		ASI-2226-001	EXTENDER NO. 6: ALI-80/MSI-80/VSI-80
	638-2227-001	ROCKWELL COLLINS		ASI-2227-001	EXTENDER KIT (INCLUDES NO. 1 THRU NO. 6)
	638-2362-001	ROCKWELL COLLINS		ASI-33-81C	RF/TCR CABLE
	638-2383-001	ROCKWELL COLLINS		ASI-33-83A	TCR CABLE
	638-2384-001	ROCKWELL COLLINS		ASI-33-83B	PWR CABLE
	638-2385-001	ROCKWELL COLLINS		ASI-33-83C	AAC CABLE
	638-2388-001	ROCKWELL COLLINS		ASI-33-81D	RF/PWR CABLE
	638-2389-002	ROCKWELL COLLINS		ASI-2389-002	INTERCONNECT CABLE SET
	638-2390-001	ROCKWELL COLLINS		ASI-2390-001	EXT CABLE SET FOR AN/ARC-186
	638-2390-002	ROCKWELL COLLINS		ASI-2390-002	EXT CABLE SET FOR AN/ARC-186 (W/1553 CABLES)
	638-2404-001	ROCKWELL COLLINS		ASI-33-83D	ALC CAPACITOR
	638-2405-001	ROCKWELL COLLINS		ASI-33-81A	TEST FIXTURE: ALC MONITOR
	638-2406-001	ROCKWELL COLLINS		ASI-33-81B	TEST FIXTURE: SNIFFER
	638-2433-001	ROCKWELL COLLINS		ASI-29-4A	CABLE: ASI-294 (970D-2) TO ADC-80()
	638-2448-001	ROCKWELL COLLINS	55-0156-02	ASI-33-84A	CABLE: AAC/PAC
	641-4652-001	ROCKWELL COLLINS		ASI-4652-001	EXTENDER BOARD NO. 1 FOR 590A-3K/K1
	641-4652-002	ROCKWELL COLLINS		ASI-4652-002	EXTENDER BOARD NO. 2 FOR 590A-3K/K1
	641-5058-001	ROCKWELL COLLINS		ASI-5058-001	HSI-85() CARD EXTRACTOR
	641-5058-002	ROCKWELL COLLINS		ASI-5058-002	ADI-85() CARD EXTRACTOR
	641-5761-001	ROCKWELL COLLINS		ASI-37-3A	CABLE: ASI-373 TO VHF-22
	641-5834-003	ROCKWELL COLLINS		ASI-386	AHC-85 BURN-IN PANEL
	641-5834-005	ROCKWELL COLLINS		ASI-38-6A	CABLE: ASI-386 TO AHC-85
	641-5955-001	ROCKWELL COLLINS		ASI-419	AHC-85 A7 TEST FIXTURE
	641-6133-002	ROCKWELL COLLINS		ASI-37-3B	CABLE: ASI-373 TO VHF-422S
	641-6388-900	ROCKWELL COLLINS		ASI-382	VIR-32/432 INTERFACE PANEL
	641-6388-902	ROCKWELL COLLINS		ASI-38-2A	CABLE: ASI-382 TO VIR-32
	641-6388-903	ROCKWELL COLLINS		ASI-38-2B	CABLE: ASI-382 TO VIR-432
	641-6468-001	ROCKWELL COLLINS		ASI-370	ANT-462 T/L TEST PANEL
	641-6468-002	ROCKWELL COLLINS		ASI-37-0A	CABLE: ASI-370 TO ANT-462
	642-6964-001	ROCKWELL COLLINS		ASI-6964-628T	678P-1 TEST KIT (INCLUDES ASI-209-8 AND ASI-209-9)
	642-6964-010	ROCKWELL COLLINS	55-0480-00	ASI-209-9	BREAKOUT BOX
	642-6964-011	ROCKWELL COLLINS		ASI-209-8	678P-1/2 (ASI-209-X) TEST SET ADAPTER FOR 628T-2/2A (MAN FIG 906)
	642-7952-001	ROCKWELL COLLINS		ASI-209-10	678P-1/2 (ASI-209-X) TEST SET ADAPTER FOR 628T-3/3A (MAN FIG 905-906)
	646-3759-001	ROCKWELL COLLINS		ASI-707C	DME-700 A5 ALIGNMENT COVER
	646-3780-001	ROCKWELL COLLINS		ASI-707B	DME-700 A3 ALIGNMENT COVER
	646-3781-001	ROCKWELL COLLINS		ASI-707A	DME-700 A4 ALIGNMENT COVER
	646-6578-001	ROCKWELL COLLINS		ASI-31-0G	CABLE: ASI-310 (438K-2) W8
	646-7779-001	ROCKWELL COLLINS		ASI-7779-DLM(L)	DLM-700() CIRCUIT CARD EXTENDER-LEFT (A3, A4, A5)
	646-7779-002	ROCKWELL COLLINS		ASI-7779-DLM(R)	DLM-700() CIRCUIT CARD EXTENDER-RIGHT (A6, A7)
	646-7830-001	ROCKWELL COLLINS		ASI-7830-001	EXTENDER CARD
	646-8260-001	ROCKWELL COLLINS		ASI-8260-DLC	PART OF ASI-DLC-800 MAINTENANCE KIT
	646-8260-002	ROCKWELL COLLINS	01-0427-00	ASI-8261-DLC	PART OF ASI-DLC-800 MAINTENANCE KIT
	647-0283-001	ROCKWELL COLLINS	01-0428-00	ASI-729	POWER SUPPLY TEST FIXTURE FOR WMA-701X
	647-1934-000	ROCKWELL COLLINS	01-0476-00	ASI-1934-DLC	DLC-800 BACKLIGHT TEST FIXTURE
	647-1997-001	ROCKWELL COLLINS	01-0510-00	ASI-726	MOTOR DRIVER TEST FIXTURE FOR WMA-701X
	647-2036-001	ROCKWELL COLLINS	01-0478-00	ASI-74-0A	CABLE: ASI-740 TO EDU-766/776
	647-2143-001	ROCKWELL COLLINS		ASI-700-4-05	POWER SUPPLY TEST SET, HFS-900/628T-()
	647-3825-001	ROCKWELL COLLINS		ASI-18-9E	BACKLASH TEST FIXTURE

OEM TO ASI EQUIVALENT CROSS REFERENCE

<u>EQUIV MN</u>	<u>EQUIV PN</u>	<u>EQUIV OEM</u>	<u>JC-AIR PN</u>	<u>ASI MN</u>	<u>DESCRIPTION</u>
	647-4015-001	ROCKWELL COLLINS		ASI-4015-186	INTERCONNECT CABLE SET FOR AN/ARC-186
	647-4016-001	ROCKWELL COLLINS		ASI-4016-001	CABLE: W1
	647-4093-001	ROCKWELL COLLINS		ASI-4093-001	CABLE: W2
	647-4094-001	ROCKWELL COLLINS		ASI-4094-001	CABLE: W3
	647-4095-001	ROCKWELL COLLINS		ASI-4095-001	CABLE: W4
	647-4096-001	ROCKWELL COLLINS		ASI-4096-001	CABLE: W5
	647-4762-001	ROCKWELL COLLINS		ASI-191-4	331A-3G BREAKOUT BOX
	647-4868-001	ROCKWELL COLLINS		ASI-74-0C	CABLE: ASI-740 TO BLACK LABEL POWER SUPPLIES
	647-5733-002	ROCKWELL COLLINS		ASI-718	LRA-700 RF TUNING COVER
	647-6485-001	ROCKWELL COLLINS		ASI-25-9C	SERVO ASSY PIN NO 1 (RDMI-743)
	647-6485-002	ROCKWELL COLLINS		ASI-25-9D	SERVO ASSY PIN NO 2 (RDMI-743)
	647-6485-003	ROCKWELL COLLINS		ASI-25-9A	SERVO ASSY PIN NO. 3 (339H-6 MAN FIG 920)
	647-6485-004	ROCKWELL COLLINS		ASI-25-9B	SERVO ASSY PIN NO. 4 (MAN FIG 920)
	647-6485-005	ROCKWELL COLLINS		ASI-25-9E	SERVO ASSY PIN NO 5
	647-6750-001	ROCKWELL COLLINS		ASI-412-1	TEST FIXTURE: BED OF NAILS (P/O ASI-412)
	647-6787-001	ROCKWELL COLLINS		ASI-200-5A1	DIGITAL DME SIMULATOR AND CASE
	647-8028-001	ROCKWELL COLLINS	20-5043-00	ASI-740	EFIS LVPS TEST PANEL
	647-8076-004	ROCKWELL COLLINS	01-0044-00	ASI-701-1C	CABLE: SUPPLY INTERFACE (ASI-701)
	647-8158-001	ROCKWELL COLLINS		ASI-74-0B	CABLE: ASI-740 TO RED LABEL POWER SUPPLIES
	647-8457-001	ROCKWELL COLLINS		ASI-314	ARN-118 TEST INTERFACE ADAPTER
	647-8773-001	ROCKWELL COLLINS		ASI-705	POWER SUPPLY FIXTURE (EAP-701() MAN. FIG. 903-904)
	647-8962-001	ROCKWELL COLLINS		ASI-11-1D	CABLE: ADI-77 EXTENDER
	647-8962-002	ROCKWELL COLLINS		ASI-11-1E	CABLE: ADI-77 EXTENDER
	647-8962-003	ROCKWELL COLLINS		ASI-11-1F	CABLE: ADI-77 EXTENDER
	647-8962-004	ROCKWELL COLLINS		ASI-11-1G	CABLE: ADI-77 EXTENDER
	647-8962-005	ROCKWELL COLLINS		ASI-11-1H	CABLE: ADI-77 EXTENDER
	647-8962-006	ROCKWELL COLLINS		ASI-11-1I	CABLE: ADI-77 EXTENDER
	647-8962-020	ROCKWELL COLLINS		ASI-11-1J	CABLE: ADI-77 EXTENDER
	647-9262-001	ROCKWELL COLLINS		ASI-344	DAU-850 TEST ADAPTER (FOR CTS-2000)
	649-0491-001	HONEYWELL (ALLIED SIGNAL)		ASI-0491-001	BREAKOUT BOX ASSEMBLY
	649-0491-002	HONEYWELL (ALLIED SIGNAL)		ASI-0491-002	BREAKOUT BOX ASSEMBLY
	649-0970-000	HONEYWELL (BENDIX)		ASI-77-1E	DAA-4A DUMMY ANTENNA WEIGHT (INCLUDES ASI-77-1E1 AND ASI-771E2)
	649-0970-001	HONEYWELL (BENDIX)	01-0340-00	ASI-77-1E1	DAA-4A DUMMY ANTENNA WEIGHT 1 (PART OF ASI-77-1E)
	649-0970-002	HONEYWELL (BENDIX)		ASI-77-1E2	DAA-4A DUMMY ANTENNA WEIGHT 2 (PART OF ASI-77-1E)
	651-1902-001	ROCKWELL COLLINS		ASI-1902-001	WRT-701X PWR AMP TEST COVER
	651-1903-001	ROCKWELL COLLINS		ASI-1903-001	WRT-701X COUPLER LOAD PORT ADAPTER
	651-1904-001	ROCKWELL COLLINS		ASI-1904-001	WRT-701X EXTENDER CABLE (P/O ASI-7994-701X)
	651-1904-002	ROCKWELL COLLINS		ASI-1904-002	WRT-701X EXTENDER CABLE (P/O ASI-7994-701X)
	651-1904-003	ROCKWELL COLLINS		ASI-1904-003	WRT-701X EXTENDER CABLE (P/O ASI-7994-701X)
	651-1904-004	ROCKWELL COLLINS		ASI-1904-004	WRT-701X EXTENDER CABLE (P/O ASI-7994-701X)
	651-1904-005	ROCKWELL COLLINS		ASI-1904-005	WRT-701X EXTENDER CABLE (P/O ASI-7994-701X)
	651-1904-006	ROCKWELL COLLINS		ASI-1904-006	WRT-701X EXTENDER CABLE (P/O ASI-7994-701X)
	651-1904-007	ROCKWELL COLLINS	01-0342-00	ASI-1904-007	WRT-701X EXTENDER CABLE (P/O ASI-7994-701X)
	651-1904-008	ROCKWELL COLLINS		ASI-1904-008	WRT-701X EXTENDER CABLE (P/O ASI-7994-701X)
	651-1909-001	ROCKWELL COLLINS		ASI-1909-001	WRT-701X EXTENDER CABLE (P/O ASI-7994-701X)
	651-1910-001	ROCKWELL COLLINS		ASI-1910-001	WRT-701X MULTIPLIER TEST FIXTURE (P/O ASI-7994-701X)
	651-1914-001	ROCKWELL COLLINS		ASI-1914-001	WRT-701X EXTENDER CABLE (P/O ASI-7994-701X)
	651-1915-001	ROCKWELL COLLINS		ASI-1915-001	WRT-701X TEST COVER (P/O ASI-7994-701X)
	651-1916-001	ROCKWELL COLLINS		ASI-1916-001	WRT-701X TEST COVER (P/O ASI-7994-701X)
	651-1917-001	ROCKWELL COLLINS		ASI-1917-001	WRT-701X TEST COVER (P/O ASI-7994-701X)
	651-1918-001	ROCKWELL COLLINS		ASI-1918-001	WRT-701X TEST COVER (P/O ASI-7994-701X)
	651-1919-001	ROCKWELL COLLINS		ASI-1919-001	WRT-701X TEST COVER (P/O ASI-7994-701X)
	651-1920-001	ROCKWELL COLLINS		ASI-1920-001	WRT-701X TEST COVER (P/O ASI-7994-701X)
	651-3028-001	ROCKWELL COLLINS		ASI-30-2B	CABLE: ASI-302 (966B-1) TO POWER SUPPLY
	651-3032-001	ROCKWELL COLLINS		ASI-30-2A	CABLE: ASI-302 (966B-1) TO POWER AMP
	651-3121-001	ROCKWELL COLLINS		ASI-3121-001	CABLE: 966D-5A TO R/T
	651-3244-001	ROCKWELL COLLINS		ASI-329-33	TEST RF FEEDLINE FOR CU-2314(V)3/ARC-190(V)
	651-3262-001	ROCKWELL COLLINS		ASI-329-32	TEST RF FEEDLINE FOR CU-2314(V)2/ARC-190(V)
	651-3663-001	ROCKWELL COLLINS		ASI-30-2C	CABLE: ASI-302 (966B-1) RF
	651-3667-001	ROCKWELL COLLINS		ASI-30-2D	CABLE: ASI-302 (966B-1) RF
	651-3667-002	ROCKWELL COLLINS		ASI-30-2E	CABLE: ASI-302 (966B-1) RF
	651-3669-001	ROCKWELL COLLINS		ASI-30-2F	CABLE: ASI-302 (966B-1) RF
	652-2416-001	ROCKWELL COLLINS		ASI-329-31	TEST RF FEEDLINE FOR CU-2314(V)1/ARC-190(V)
	652-2419-001	ROCKWELL COLLINS		ASI-329-34	TEST RF FEEDLINE FOR CU-2314(V)4/ARC-190(V)
	652-2440-001	ROCKWELL COLLINS		ASI-329-141	TEST RF FEEDLINE FOR CU-2275(V)3
	652-2443-001	ROCKWELL COLLINS		ASI-207-13	CPL-920D TEST ADAPTER
	652-5939-001	ROCKWELL COLLINS		ASI-256	SERVO CALIBRATION FIXTURE
	652-9483-001	ROCKWELL COLLINS		ASI-9483-001	CABLE: W6
	652-9484-001	ROCKWELL COLLINS		ASI-9484-001	CABLE: W7
	652-9485-001	ROCKWELL COLLINS		ASI-9485-001	CABLE: W8
	652-9486-001	ROCKWELL COLLINS		ASI-9486-001	CABLE: W9
	652-9487-001	ROCKWELL COLLINS		ASI-9487-001	CABLE: W10
	652-9488-001	ROCKWELL COLLINS		ASI-9488-001	CABLE: W11
	652-9764-001	ROCKWELL COLLINS		ASI-701	EDU HVPS TEST SET
	653-1078-001	ROCKWELL COLLINS	01-0045-00	ASI-41-21	CABLE: ASI-412 (CTS-64) P10
	653-1288-002	ROCKWELL COLLINS		ASI-40-3E	CABLE: ASI-403 (972S-5) TO SVO-1000
	653-2159-001	ROCKWELL COLLINS		ASI-Y-2	CABLE: CTL-230 Y-ADAPTER
	653-2360-001	ROCKWELL COLLINS		ASI-37-9A	CABLE: ASI-379 TO EFIS
	653-2361-001	ROCKWELL COLLINS		ASI-37-9B	CABLE: ASI-379 TO WXP-4000
	653-2362-001	ROCKWELL COLLINS		ASI-37-9C	CABLE: ASI-379 TO STD-7000
	653-4242-001	ROCKWELL COLLINS		ASI-3109-002	CABLE: ASI-CTS-958 TO AHC-3000/A
	653-5113-001	ROCKWELL COLLINS		ASI-817	RF/SIGNAL DISTRIBUTION PANEL WITH CABLE
	659-3423-001	ROCKWELL COLLINS		ASI-3423-001	DFC-206A CONTROL TEST PANEL
	659-3483-001	ROCKWELL COLLINS		ASI-37-5B	CABLE: ASI-375 TO ADF ANTENNA
	659-3486-001	ROCKWELL COLLINS		ASI-37-5A	CABLE: ASI-375 TO ADF RECEIVER AND CONTROL

OEM TO ASI EQUIVALENT CROSS REFERENCE

EQUIV MN	EQUIV PN	EQUIV OEM	JC-AIR PN	ASI MN	DESCRIPTION
	659-3488-001	ROCKWELL COLLINS		ASI-309	1553 ADDRESS BOX
	659-3488-002	ROCKWELL COLLINS		ASI-30-9A	CABLE: ASI-309 1553 ADDRESS CABLE
	659-3597-001	ROCKWELL COLLINS		ASI-37-6A	CABLE: ASI-376 I/O
	659-3598-001	ROCKWELL COLLINS	50-0007-01	ASI-37-B1	CABLE: ASI-376 MB
	659-3598-002	ROCKWELL COLLINS		ASI-37-B2	CABLE: ASI-376 RF
	659-3598-003	ROCKWELL COLLINS		ASI-37-B3	CABLE: ASI-376 NR
	659-3598-004	ROCKWELL COLLINS		ASI-37-B4	CABLE: ASI-376 GS
	659-3603-001	ROCKWELL COLLINS		ASI-37-B5	CABLE: ASI-376 CONTROL
	659-3933-001	ROCKWELL COLLINS		ASI-37-6D	1553 BUS ADAPTER VIR-130A TO ALTANTIS DCM-1553
	659-7994-001	ROCKWELL COLLINS		ASI-7994-701C	WRT-701C MAINTENANCE KIT
	659-7994-002	ROCKWELL COLLINS		ASI-7994-701X	WRT-701X MAINTENANCE KIT
	659-8431-001	ROCKWELL COLLINS	50-0007-00	ASI-8431-001	SDU-640 PROG FIXTURE ASSY
	659-8732-001	ROCKWELL COLLINS		ASI-9557-DLM	DLM-700() POWER SUPPLY A6 TEST FIXTURE
	659-8803-003	ROCKWELL COLLINS	01-0343-00	ASI-8803-DLM	DLM-700 DATA LINK TEST ADAPTER
	659-8804-001	ROCKWELL COLLINS		ASI-7779-DLM(L)	DLM-700 CIRCUIT CARD EXTENDER
	659-8804-002	ROCKWELL COLLINS		ASI-7779-DLM(R)	DLM-700 CIRCUIT CARD EXTENDER
	676-1949-001	ROCKWELL COLLINS	01-0338-00	ASI-249	SVT-1000 TEST PANEL / RUN-IN FIXTURE
	676-1949-011	ROCKWELL COLLINS		ASI-24-9A	CABLE: ASI-249 TO SVT-1000
	676-3842-001	ROCKWELL COLLINS		ASI-3842-DLM	DLM POWER SUPPLY TEST SET
	676-3866-001	ROCKWELL COLLINS		ASI-40-41C	BCA-770 TORQUE BACKLASH TEST FIXTURE (REQ USER SUPPLIED 25-241J)
	676-3871-001	ROCKWELL COLLINS		ASI-40-41A	BACKLASH TEST FIXTURE (REQ USER 25-241 DIAL INDICATOR)
	676-3923-001	ROCKWELL COLLINS		ASI-404-1	BCA SERVO TEST SET FOR BCA-770
	676-6715-001	ROCKWELL COLLINS		ASI-376-5	AM-X ADAPTER
	676-6722-001	ROCKWELL COLLINS		ASI-37-6E	CABLE: ASI-37-6D TO ATLANTIS DCM-1553
	676-7385-001	ROCKWELL COLLINS		ASI-747	BUS BUFFER CARD
	676-7387-003	ROCKWELL COLLINS		ASI-746-1	RAM BUFFER CARD
	676-7387-003	ROCKWELL COLLINS		ASI-746-2	SDU-906-900 RAM BUFFER CARD
	685-1179-001	ROCKWELL COLLINS		ASI-777-6	HF-9000 LOWPASS FILTER TEST FIXTURE
	685-1807-001	ROCKWELL COLLINS		ASI-777-8	HF-9000 POWER AMPLIFIER TEST PANEL
	685-6220-001	ROCKWELL COLLINS		ASI-250	590B-2 TEST AID
	685-6238-001	ROCKWELL COLLINS		ASI-378-8	WXP-840/850 TEST ADAPTER
	685-6295-001	ROCKWELL COLLINS		ASI-251	CTS-859 TERMINAL TO IBM SWITCH UNIT (ALT PN 628-8839-001)
	685-6461-ASI	ROCKWELL COLLINS		ASI-CTS-964	JC CONTROL PANEL
	685-6581-001	ROCKWELL COLLINS		ASI-156	AHC-85 AHRS MONITOR INTERFACE PANEL
	685-6590-001	ROCKWELL COLLINS		ASI-15-6A	CABLE: ASI-156 TO AHC-85
	685-6824-001	ROCKWELL COLLINS		ASI-CTS-947	A7 IF/ LVPS TEST PANEL
	687-4041-001	ROCKWELL COLLINS		ASI-17-72K	1553 BUS ADAPTER VIR-130A TO ALTANTIS DCM-1553
	687-7724-001	ROCKWELL COLLINS		ASI-37-5C	RF ATTENUATOR
	687-7902-001	ROCKWELL COLLINS		ASI-18-5C	CABLE: ASI-185 TO ANT-60B/462B (ADF-60 FIG 10-2, ADF-462 FIG 5-14)
	687-7931-001	ROCKWELL COLLINS		ASI-37-5D	MIL-STD-1553B BUS ADAPTER
	687-8450-001	ROCKWELL COLLINS		ASI-322	TCN-118 TEST INTERFACE ADAPTER
	687-9993-001	ROCKWELL COLLINS		ASI-15-8A	HIGH POT TEST CABLE FOR SVO-1000
	696-05641-0001	HONEYWELL (BENDIX/KING)		ASI-362	KAD-280 TEST SET (MAN FIG 5-1 - 5-3)
	696-4825-00	HONEYWELL (BENDIX/KING)		ASI-361	KVG-350 TEST PANEL (MAN FIG 5-2)
	696-6257-00	HONEYWELL (BENDIX/KING)		ASI-428-2	TEST SET FOR KA-133 / KI-250 / KRA-10/10A
	7005-3741-400	AEROFLEX (IFR)		ASI-7005-3741-400	CRT INTERFACE ASSY FOR STD-7000
	7005-3741-800	AEROFLEX (IFR)		ASI-7005-3741-800	KEYBOARD ASSY FOR STD-7000
	7005-4042-101	AEROFLEX (IFR)		ASI-7005-4042-101	EXTERNAL RD POWER MODULE ASSY FOR RDX-3000 / RDX-7708
	7007114-0502	HONEYWELL (BENDIX)		ASI-78-01C	CABLE: ASI-780-1 (P7) TO PITCH SERVO WITH AMP CONN (TS-810A-02 SB)
	7010571-901	HONEYWELL		ASI-266-4	MODULATOR DUMMY LOAD
	7015904-904	HONEYWELL		ASI-266-5	DIGITAL PROTRACTOR ADAPTER
	747-0446-001	HONEYWELL (BENDIX)		ASI-80-3B	CABLE: ASI-803 (RTT-44A) AND RTA-83A
	751-0519-001	ROCKWELL COLLINS		ASI-0519-001	THINLINE EXTRACTOR (INCL TOOL 751-0519-001 & HANDLE 007-0611-000)
	751-1762-001	ROCKWELL COLLINS		ASI-30-1G	CABLE: ASI-301 (973W-3) W7
	751-1765-001	ROCKWELL COLLINS		ASI-30-1F	CABLE: ASI-301 (973W-3) W6
	751-1766-001	ROCKWELL COLLINS		ASI-30-1D	CABLE: ASI-301 (973W-3) W4
	751-1766-002	ROCKWELL COLLINS		ASI-30-1E	CABLE: ASI-301 (973W-3) W5
	751-1767-001	ROCKWELL COLLINS		ASI-30-1A	CABLE: ASI-301 (973W-3) W1
	751-1767-002	ROCKWELL COLLINS		ASI-30-1B	CABLE: ASI-301 (973W-3) W2
	751-1767-003	ROCKWELL COLLINS		ASI-30-1C	CABLE: ASI-301 (973W-3) W3
	751-2412-001	ROCKWELL COLLINS		ASI-77-8D	CABLE: ASI-778 (TE-9400) W1
	751-2412-002	ROCKWELL COLLINS		ASI-77-8E	CABLE: ASI-778 (TE-9400) W13
	751-2412-003	ROCKWELL COLLINS		ASI-77-8F	CABLE: ASI-778 (TE-9400) W14
	751-2413-001	ROCKWELL COLLINS		ASI-77-8G	CABLE: ASI-778 (TE-9400) W2
	751-2413-002	ROCKWELL COLLINS		ASI-77-8H	CABLE: ASI-778 (TE-9400) W15
	751-2414-001	ROCKWELL COLLINS		ASI-77-8J	CABLE: ASI-778 (TE-9400) W3
	751-2415-001	ROCKWELL COLLINS		ASI-77-8K	CABLE: ASI-778 (TE-9400) W4
	751-2416-001	ROCKWELL COLLINS		ASI-77-8L	CABLE: ASI-778 (TE-9400) W5
	751-2417-001	ROCKWELL COLLINS		ASI-77-8M	CABLE: ASI-778 (TE-9400) W6
	751-2417-002	ROCKWELL COLLINS		ASI-77-8N	CABLE: ASI-778 (TE-9400) W16
	751-2422-001	ROCKWELL COLLINS		ASI-77-8P	CABLE: ASI-778 (TE-9400) W7
	751-2423-001	ROCKWELL COLLINS		ASI-77-8Q	CABLE: ASI-778 (TE-9400) W8
	751-2424-001	ROCKWELL COLLINS		ASI-77-8R	CABLE: ASI-778 (TE-9400) W9
	751-2425-001	ROCKWELL COLLINS		ASI-77-8S	CABLE: ASI-778 (TE-9400) W10
	751-2426-001	ROCKWELL COLLINS		ASI-77-8T	CABLE: ASI-778 (TE-9400) W11
	751-2427-001	ROCKWELL COLLINS		ASI-77-8U	CABLE: ASI-778 (TE-9400) W12
	751-3081-001	ROCKWELL COLLINS		ASI-77-8A	EXTENDER CARD: ASI-778 (TE-9400) A1
	751-3082-001	ROCKWELL COLLINS		ASI-77-8B	EXTENDER CARD: ASI-778 (TE-9400) A3
	751-3082-002	ROCKWELL COLLINS		ASI-77-8C	EXTENDER CARD: ASI-778 (TE-9400) A3
	751-5126-001	ROCKWELL COLLINS		ASI-77-8V	CABLE: ASI-778 (TE-9400) W17
	751-7477-001	ROCKWELL COLLINS		ASI-77-7G	CABLE: ASI-777 (TE-9210) FIBER OPTIC
	751-8272-001	ROCKWELL COLLINS		ASI-30-1H	CABLE: ASI-301 (973W-3) W8
	752-7263-001	ROCKWELL COLLINS		ASI-7263-001	CABLE: MEMORY EXTENDER
	752-7264-001	ROCKWELL COLLINS		ASI-7264-001	CABLE: EXTENDER
	752-7264-002	ROCKWELL COLLINS		ASI-7264-002	CABLE: EXTENDER

OEM TO ASI EQUIVALENT CROSS REFERENCE

EQUIV MN	EQUIV PN	EQUIV OEM	JC-AIR PN	ASI MN	DESCRIPTION
	752-7275-001	ROCKWELL COLLINS		ASI-32-4A	CABLE: ASI-324 (964R-2) W1
	752-8342-001	ROCKWELL COLLINS		ASI-8342-001	DIPLEXER/PREAMP TEST FIXTURE (WITH 2 CABLES)
	752-8896-001	ROCKWELL COLLINS		ASI-207-5	CPL-920D CONTROL CARD TEST SET (INCLUDES W1 AND W2) (TE1)
	756-5248-004	ROCKWELL COLLINS		ASI-20-9Q	CABLE: ASI-209 TO 488A-2
	756-5248-005	ROCKWELL COLLINS		ASI-20-9Q1	CABLE: ASI-209 TO 488A-2
	756-7400-001	ROCKWELL COLLINS		ASI-49-94G2	CABLE: ASI-499-4 TO AQU-2/A / AQU-4/A
	757-0544-001	ROCKWELL COLLINS		ASI-191-001	ASI-191 (978F-1D) OVERLAY FOR TESTING 329B-7
	757-0544-002	ROCKWELL COLLINS		ASI-191-002	ASI-191 (978F-1D) OVERLAY FOR TESTING 331A-7
	757-0544-003	ROCKWELL COLLINS		ASI-191-003	ASI-191 (978F-1D) OVERLAY FOR TESTING 329B-7A
	757-0544-004	ROCKWELL COLLINS		ASI-191-004	ASI-191 (978F-1D) OVERLAY FOR TESTING 329B-7C
	757-0544-005	ROCKWELL COLLINS		ASI-191-005	ASI-191 (978F-1D) OVERLAY FOR TESTING 329B-6D
	757-0544-006	ROCKWELL COLLINS		ASI-191-006	ASI-191 (978F-1D) OVERLAY FOR TESTING 331A-6A
	757-0544-007	ROCKWELL COLLINS		ASI-191-007	ASI-191 (978F-1D) OVERLAY FOR TESTING 331A-6D
	757-0544-008	ROCKWELL COLLINS		ASI-191-008	ASI-191 (978F-1D) OVERLAY FOR TESTING 331A-7A
	757-0544-009	ROCKWELL COLLINS		ASI-191-009	ASI-191 (978F-1D) OVERLAY FOR TESTING 329B-7F
	757-0544-010	ROCKWELL COLLINS		ASI-191-010	ASI-191 (978F-1D) OVERLAY FOR TESTING 329B-7F-1
	757-0544-011	ROCKWELL COLLINS		ASI-191-011	ASI-191 (978F-1D) OVERLAY FOR TESTING 329B-7G
	757-0544-012	ROCKWELL COLLINS		ASI-191-012	ASI-191 (978F-1D) OVERLAY FOR TESTING 331A-6E
	757-0544-013	ROCKWELL COLLINS		ASI-191-013	ASI-191 (978F-1D) OVERLAY FOR TESTING 329B-7J
	757-0544-014	ROCKWELL COLLINS		ASI-191-014	ASI-191 (978F-1D) OVERLAY FOR TESTING 329B-7K
	757-0544-015	ROCKWELL COLLINS		ASI-191-015	ASI-191 (978F-1D) OVERLAY FOR TESTING 329B-8C
	757-0544-016	ROCKWELL COLLINS		ASI-191-016	ASI-191 (978F-1D) OVERLAY FOR TESTING 331A-6K
	757-0544-017	ROCKWELL COLLINS		ASI-191-017	ASI-191 (978F-1D) OVERLAY FOR TESTING 329B-6E
	757-0544-018	ROCKWELL COLLINS		ASI-191-018	ASI-191 (978F-1D) OVERLAY FOR TESTING 329B-8A
	757-0544-019	ROCKWELL COLLINS		ASI-191-019	ASI-191 (978F-1D) OVERLAY FOR TESTING 329B-8B
	757-0544-020	ROCKWELL COLLINS		ASI-191-020	ASI-191 (978F-1D) OVERLAY FOR TESTING 329B-8F
	757-0544-021	ROCKWELL COLLINS		ASI-191-021	ASI-191 (978F-1D) OVERLAY FOR TESTING 329B-7M
	757-0544-022	ROCKWELL COLLINS		ASI-191-022	ASI-191 (978F-1D) OVERLAY FOR TESTING 329B-8G
	757-0544-023	ROCKWELL COLLINS		ASI-191-023	ASI-191 (978F-1D) OVERLAY FOR TESTING 329B-8N
	757-1377-001	ROCKWELL COLLINS		ASI-20-9M	CABLE: ASI-209 TO 490T-1/1A
	757-1377-002	ROCKWELL COLLINS	55-0361-04	ASI-20-9M1	CABLE: ASI-209 TO 490T-1/1A
	757-6385-001	ROCKWELL COLLINS		ASI-34-01A	CABLE: W1
	757-8979-001	ROCKWELL COLLINS		ASI-20-7G	CABLE: AC SUPPLY TO J36
	761-1496-001	ROCKWELL COLLINS		ASI-20-11F	CABLE: POWER
	761-4400-001	ROCKWELL COLLINS		ASI-32-81A	CABLE: W2
	761-4599-001	ROCKWELL COLLINS		ASI-328-4	POWER PANEL
	761-4600-001	ROCKWELL COLLINS	20-0232-14	ASI-32-84A	CABLE: W1
	761-4790-001	ROCKWELL COLLINS		ASI-20-9P	CABLE: ASI-209 TO 313V-1
	761-4790-002	ROCKWELL COLLINS		ASI-20-9P1	CABLE: ASI-209 TO 313V-1
	761-4969-001	ROCKWELL COLLINS		ASI-20-9R	CABLE: ASI-209 TO DC PWR
	761-4971-001	ROCKWELL COLLINS		ASI-20-9N	CABLE: ASI-209 TO 490B-1
	761-4971-002	ROCKWELL COLLINS		ASI-20-9N1	CABLE: ASI-209 TO 490B-1
	761-5230-006	ROCKWELL COLLINS		ASI-191-024	ASI-191 (978F-1D) OVERLAY FOR TESTING 331A-3G/6P/HSI-70
	762-1496-001	ROCKWELL COLLINS		ASI-20-11F	CABLE: ASI-201-1 (AN/ARM-93) DC POWER
	762-1496-002	ROCKWELL COLLINS		ASI-20-1F	CABLE: ASI-201-2 (477U-2) DC POWER
	762-1499-003	ROCKWELL COLLINS		ASI-20-11E	TEST FIXTURE: ASI-201-1 (AN/ARM-93) ADF LOOP ANTENNA
	762-1499-004	ROCKWELL COLLINS		ASI-20-1E	TEST FIXTURE: ASI-201-2 (477U-3) ADF LOOP ANTENNA
	762-1551-001	ROCKWELL COLLINS		ASI-20-11A	CABLE: ASI-201-1 (AN/ARM-93) RF INPUT
	762-1551-002	ROCKWELL COLLINS		ASI-20-1A	CABLE: ASI-201-2 (477U-3) RF INPUT
	762-1561-001	ROCKWELL COLLINS		ASI-20-11B	CABLE: ASI-201-1 (AN/ARM-93) INVERTER SERVICING
	762-1561-002	ROCKWELL COLLINS		ASI-20-1B	CABLE: ASI-201-2 (477U-3) INVERTER SERVICING
	762-1667-001	ROCKWELL COLLINS		ASI-20-11D	CABLE: ASI-201-1 (AN/ARM-93) LOW CAP SENSE ADAPTER
	762-1667-002	ROCKWELL COLLINS		ASI-20-1D	CABLE: ASI-201-2 (477U-3) LOW CAP SENSE ADAPTER
	769-4969-002	ROCKWELL COLLINS		ASI-20-9R1	CABLE: ASI-209 TO DC PWR
	772-0998-001	ROCKWELL COLLINS		ASI-0998-001	590A-3 ALLEN-HEAD WRENCH
	772-6871-001	ROCKWELL COLLINS		ASI-346-4	980H-3 POWER PANEL
	772-6874-001	ROCKWELL COLLINS		ASI-33-91B	HOUSING
	772-6875-001	ROCKWELL COLLINS		ASI-33-91C	HOUSING
	772-6877-001	ROCKWELL COLLINS		ASI-34-63A	RF CABLE
	772-6878-001	ROCKWELL COLLINS		ASI-34-64A	POWER CABLE
	775-9706-001	ROCKWELL COLLINS		ASI-33-9A	W1 CABLE
	787-8303-001	ROCKWELL COLLINS		ASI-33-93C	CARD EXTENDER
	787-8891-001	ROCKWELL COLLINS		ASI-33-94B	1W2 CABLE
	791-0740-001	ROCKWELL COLLINS		ASI-0740-001	51RV-2B SLICE EXTENDER KIT
	791-3366-001	ROCKWELL COLLINS		ASI-33-94A	CARD HOLDER
	791-3381-001	ROCKWELL COLLINS		ASI-33-92B	CARD EXTENDER
	791-3393-001	ROCKWELL COLLINS		ASI-33-92A	CABLE: 3W2
	791-8001-001	ROCKWELL COLLINS		ASI-8001-001	51RV-2B CARD EXT CABLE FOR MANUAL VOR/LOC SENSOR CARD Z2
	791-8048-001	ROCKWELL COLLINS		ASI-8048-001	51RV-2B CARD EXTENDER KIT
	791-8153-001	ROCKWELL COLLINS		ASI-18-1A	CABLE: ASI-181 (975D-1) TO 860E-3
	791-8381-001	ROCKWELL COLLINS		ASI-18-2G	TUBE EXTENDER A FOR 860E-3
	791-8390-001	ROCKWELL COLLINS		ASI-18-2H	TUBE EXTENDER B FOR 860E-3
	791-8405-001	ROCKWELL COLLINS		ASI-8405-001	MAINTENANCE KIT FOR 860E-3
	792-0031-001	ROCKWELL COLLINS		ASI-33-93D	CABLE: 2W1
	792-0032-001	ROCKWELL COLLINS		ASI-33-93E	CABLE: 2W2
	792-0042-001	ROCKWELL COLLINS		ASI-33-93B	CARD ADAPTER
	792-0055-001	ROCKWELL COLLINS		ASI-33-93A	CARD HOLDER
	792-0070-001	ROCKWELL COLLINS		ASI-339-5	POWER PANEL
	792-0202-001	ROCKWELL COLLINS		ASI-33-95A	CABLE: POWER
	797-7008-001	ROCKWELL COLLINS		ASI-40Y-11-1	345C-2A POSITIONING FIXTURE
	8050799-0501	HONEYWELL (BENDIX)		ASI-244-4	CON-1TB TEST ADAPTER
	8056285-0501	HONEYWELL (BENDIX)		ASI-244-2B	CABLE: ASI-244-2 (PPT-1FB) W102
	8056302-0501	HONEYWELL (BENDIX)		ASI-15-3C	CABLE: ASI-153 (ATT-1T) W103
	8056334-0501	HONEYWELL (BENDIX)		ASI-15-22A	CABLE: ASI-152-2 (RDT-1FB) W101
	8056342-0501	HONEYWELL (BENDIX)		ASI-15-42E	CABLE: ASI-154-2 (RCT-1FB) W105

OEM TO ASI EQUIVALENT CROSS REFERENCE

EQUIV MN	EQUIV PN	EQUIV OEM	JC-AIR PN	ASI MN	DESCRIPTION
	8056346-0501	HONEYWELL (BENDIX)		ASI-15-42A	CABLE: ASI-154-2 (RCT-1FB) W101
	8057258-0501	HONEYWELL (BENDIX)		ASI-79-9A	CABLE: ASI-799 TO RDR-4 CABLE (MUST BE WIRED TO RDR-4 CABLE)
	8057438-0501	HONEYWELL (BENDIX)		ASI-74-3D	CABLE: ASI-743 (AIT-4A) TO ITA W4
	8072585-0501	HONEYWELL (BENDIX)		ASI-42-6A	CABLE: ASI-426 TO DA-1503A (W1)
	8072586-0501	HONEYWELL (BENDIX)		ASI-42-6B	CABLE: ASI-426 TO DC POWER (W2)
	8072587-0501	HONEYWELL (BENDIX)		ASI-42-6C	CABLE: ASI-426 TO IU-1507A (W3)
	8072588-0501	HONEYWELL (BENDIX)		ASI-42-6D	CABLE: ASI-426 TO MT-1508A (W4)
	8072589-0501	HONEYWELL (BENDIX)		ASI-42-6E	CABLE: ASI-426 TO DA-1203A (W5)
	8072590-0501	HONEYWELL (BENDIX)		ASI-42-6F	CABLE: ASI-426 TO CC-2024 (W6)
	8072591-0501	HONEYWELL (BENDIX)		ASI-42-6G	CABLE: ASI-426 TO IN-1502A (W7)
	8072594-0501	HONEYWELL (BENDIX)		ASI-42-6J	CABLE: ASI-426 TO RT-1501A (W9)
	8072622-0501	HONEYWELL (BENDIX)		ASI-42-6K	CABLE: ASI-426 TO IN-1502B (W10)
	8072625-0502	HONEYWELL (BENDIX)		ASI-74-3C	CABLE: ASI-743 (AIT-4A) TO PPI-4B W3
	8072626-0502	HONEYWELL (BENDIX)		ASI-74-3A	CABLE: ASI-743 (AIT-4A) TO PPI-1T W1
	8072628-0502	HONEYWELL (BENDIX)		ASI-74-3B	CABLE: ASI-743 (AIT-4A) TO PPI-1U W2
	8073780-0001	HONEYWELL (BENDIX)		ASI-76-0B	CABLE: ASI-760 TO CCA-4A
	807-40-1	ROCKWELL COLLINS		ASI-811-8	TEST SET
	8090950-0001	HONEYWELL (BENDIX)		ASI-360-2	NC-104 COMPOSITE TEST PANEL
	8091209-0001	HONEYWELL (BENDIX)		SAI-360-21	TEST MODULE FOR NC-104
	815-2274-001	ROCKWELL COLLINS		ASI-269-8	BUFFER ADAPTER (W/2 CABLES)
	822-1577-001	ROCKWELL COLLINS		ASI-1577-001	TEST ADAPTER ASSY
	822-1588-001	ROCKWELL COLLINS		ASI-1588-001	TEST ADAPTER ASSY
	822-2058-001	ROCKWELL COLLINS		ASI-2058-001	JTRS CLUSTER 1 RF MUX PANEL
	827-0182-001	ROCKWELL COLLINS	01-0426-00	ASI-0182-DLC	DLC-800() POWER SUPPLY TEST FIXTURE
	827-0200-003	ROCKWELL COLLINS		ASI-714-2	IDENT SIGNAL GENERATOR (REPLACED ASI-714-2)
	827-0201-001	ROCKWELL COLLINS	01-0328-00	ASI-0201-DLM	DLM-700() BREAKOUT TO MU CABLE
	827-0201-004	ROCKWELL COLLINS		ASI-0202-DLM	DLM-700() BREAKOUT TO LOOP BACK CABLE
	827-0332-001	ROCKWELL COLLINS		ASI-40-41B2	SLIP CLUTCH CHECK FIXTURE (INCLUDED WITH ASI-40-41B)
	827-0465-001	ROCKWELL COLLINS		ASI-0465-DLC	DLC-800() TEST PANEL W/CABLE
	827-0465-003	ROCKWELL COLLINS	01-0425-00	ASI-0465-003	CABLE: ASI-0465-DLC TO DLC-800()
	827-1090-001	ROCKWELL COLLINS		ASI-40-32A	SVO-85C/1000 BACKLASH/TORQUE TEST FIXTURE
	827-1100-002	ROCKWELL COLLINS		ASI-1100-DLM	DLM-700() BREAKOUT PANEL
	827-1130-001	ROCKWELL COLLINS	01-0339-00	ASI-1130-DLM	DLM-700() POWER DISTRIBUTION PANEL W/3 CABLES
	827-1522-009	ROCKWELL COLLINS	01-0341-10	ASI-1522-DLM	DLM-700() ACARS LOOPBACK POD
	827-1543-001	ROCKWELL COLLINS		ASI-34-82C	CLUTCH TEST FIXTURE
	827-1646-001	ROCKWELL COLLINS		ASI-40-41B1	PRESSURE CHECK FITTING (INCLUDED WITH ASI-40-41B)
	827-2298-001	ROCKWELL COLLINS		ASI-40-31J	SVO-85 BRUSH ADJUSTMENT FIXTURE
	827-2370-101	ROCKWELL COLLINS		ASI-2370-101	DCP-5020 TEST ADAPTER
	827-2370-102	ROCKWELL COLLINS		ASI-2370-102	DCP-3030 TEST ADAPTER
	827-2370-104	ROCKWELL COLLINS		ASI-2370-104	DCP-3000 TEST ADAPTER
	827-2421-001	ROCKWELL COLLINS		ASI-2421-001	SVO-3000 CABLE ASSY
	827-2421-002	ROCKWELL COLLINS		ASI-2421-002	SVO-3000 CABLE ASSY
	827-2421-003	ROCKWELL COLLINS		ASI-2421-003	SVO-3000 CABLE ASSY
	827-2647-001	ROCKWELL COLLINS		ASI-2647-001	DCP-400X DATA LOADER CABLE ASSY
	827-2704-001	ROCKWELL COLLINS		ASI-40-32Q	SERVO MOUNT HOUSING LEAK CHECK FIXTURE (INCL WITH ASI-40-32S)
	827-2780-001	ROCKWELL COLLINS		ASI-269-4	TILT SECTOR GEAR PULLER
	827-2781-001	ROCKWELL COLLINS		ASI-269-5A	SCAN SECTOR GEAR PULLER
	827-2785-001	ROCKWELL COLLINS		ASI-40-32D	CLUTCH HALF FORCE TEST TOOL (REQUIRES USER SUPPLIED 25-243)
	827-2796-001	ROCKWELL COLLINS		ASI-40-32R	SLIP CLUTCH LEAK CHECK FIXTURE (INCLUDED WITH ASI-40-32S)
	827-2952-001	ROCKWELL COLLINS		ASI-393-8	CABLE ASSY
	827-3620-001	ROCKWELL COLLINS		ASI-3620-001	CABLE ASSY
	827-3793-001	ROCKWELL COLLINS		ASI-40-32N	SVO-1000 / BCA-770 PUSHER FIXTURE
	827-3794-001	ROCKWELL COLLINS		ASI-40-32M	SVO-1000 EXPANDER FIXTURE
	827-3794-002	ROCKWELL COLLINS		ASI-40-32M1	BCA-770 EXPANDER FIXTURE
	827-3795-001	ROCKWELL COLLINS		ASI-40-32P	SVO-1000 COMPRESSOR FIXTURE
	827-3795-002	ROCKWELL COLLINS		ASI-40-32P1	BCA-770 COMPRESSOR FIXTURE
	827-3807-001	ROCKWELL COLLINS		ASI-393-7	EFD-84 LINEARITY GAUGE
	827-6554-001	ROCKWELL COLLINS		ASI-29-42A	CABLE: ASI-294-2 (970D-2A) TO ADC-80() (W1)
	827-6554-002	ROCKWELL COLLINS		ASI-29-42B	CABLE: ASI-294-2 (970D-2A) TO ADC-85/86/850 (W2)
	827-7366-001	ROCKWELL COLLINS		ASI-7366-001	CABLE: METER W3 (P/O CTA-2028)
	827-7367-001	ROCKWELL COLLINS		ASI-7367-001	CABLE: SCOPE W4 (P/O CTA-2028)
	827-7373-001	ROCKWELL COLLINS		ASI-7373-001	DCU-4000/4001 POWER MONITOR TEST AID
	827-7419-002	ROCKWELL COLLINS		ASI-7419-002	RTU-42X0 DATA LOADER CABLE ASSY
	827-7419-007	ROCKWELL COLLINS		ASI-7419-007	RTU-40X0 DATA LOADER CABLE ASSY
	827-7419-038	ROCKWELL COLLINS		ASI-7419-038	"T" DATA LOAD CABLE
	827-7841-005	ROCKWELL COLLINS		ASI-7841-005	TEMPLATE ASSY (P/O CTA-2052)
	827-7847-001	ROCKWELL COLLINS		ASI-7847-001	CABLE: CTS-2000 TO CDU-5000 (P/O CTA-2052)
	827-8271-001	ROCKWELL COLLINS		ASI-8271-001	A1 INTERFACE BOX ASSY
	827-8272-001	ROCKWELL COLLINS		ASI-8272-001	A2 INTERFACE BOX ASSY
	827-8273-001	ROCKWELL COLLINS		ASI-8273-001	A5 INTERFACE BOX ASSY
	827-8274-001	ROCKWELL COLLINS		ASI-8274-001	W49 RIBBON CABLE ASSY
	827-8274-002	ROCKWELL COLLINS		ASI-8274-002	W47 RIBBON CABLE ASSY
	827-8274-003	ROCKWELL COLLINS		ASI-8274-003	W48 RIBBON CABLE ASSY
	827-8633-005	ROCKWELL COLLINS		ASI-8633-050	TEST SET
	827-9736-001	ROCKWELL COLLINS		ASI-40Y-76-10	APC-65 GYRO MONITOR TEST SET
	828-0281-001	ROCKWELL COLLINS		ASI-759	DLM-900 I/O EXTENDER CARD
	828-0501-001	ROCKWELL COLLINS		ASI-0501-001	A1 BOARD PROGRAMMER FOR HFS-700D/900D
	828-1050-001	ROCKWELL COLLINS		ASI-0150-001	COAX SWITCHING MODULE (CSSI-1000)
	828-2551-002	ROCKWELL COLLINS		ASI-271	INCIRCUIT PROGRAMMER
	828-3109-001	ROCKWELL COLLINS		ASI-3109-001	CABLE: CTS-88
	828-3413-001	ROCKWELL COLLINS		ASI-3413-001	ADC-850 MODULE ADAPTER
	828-3413-002	ROCKWELL COLLINS		ASI-3413-002	ADC-850 MODULE ADAPTER
	828-40-1	ROCKWELL COLLINS		ASI-811-2	TEST SET FOR 828-1 (AIRSHOW / CABIN SYSTEMS)
	828-8249-001	ROCKWELL COLLINS		ASI-299	ALT-1000/4000 / -5B TEST PANEL
	830-0343-001	ROCKWELL COLLINS		ASI-0343-001	CABLE: NO. 1

OEM TO ASI EQUIVALENT CROSS REFERENCE

EQUIV MN	EQUIV PN	EQUIV OEM	JC-AIR PN	ASI MN	DESCRIPTION
	830-0344-001	ROCKWELL COLLINS		ASI-0344-001	CABLE: NO. 2
	830-0345-001	ROCKWELL COLLINS		ASI-0345-001	CABLE: NO. 3
	830-1212-001	ROCKWELL COLLINS		ASI-356-1	CIU-906 TEST PANEL (REQUIRES ASI-356-2 FOR OPERATION)
	830-1228-001	ROCKWELL COLLINS		ASI-749	SDU-906 SYSTEM PROCESSOR TEST SET
	830-1243-001	ROCKWELL COLLINS		ASI-750	SDU-906 VCO TEST FIXTURE
	830-1630-001	ROCKWELL COLLINS		ASI-751	SDU-906 MAIN UNIT TEST SET
	830-1631-001	ROCKWELL COLLINS		ASI-752	SDU-906 VCO TEST SET
	830-1635-001	ROCKWELL COLLINS		ASI-753	SDU-906 IF/SYNTHESIZER TEST SET
	830-1638-001	ROCKWELL COLLINS		ASI-754	SDU-906 CHANNEL MODULE ADAPTER
	830-1639-001	ROCKWELL COLLINS		ASI-755	SDU-906 CEPT ADAPTER TEST FIXTURE
	830-1640-001	ROCKWELL COLLINS		ASI-756	SDU-906 429 ADAPTER TEST MODULE
	830-1641-001	ROCKWELL COLLINS		ASI-757	SDU-906 REAR AUXILIARY TEST SET
	830-1643-001	ROCKWELL COLLINS		ASI-74-6A	CABLE: ASI-746 RIBBON
	830-1644-001	ROCKWELL COLLINS		ASI-74-6B	CABLE: ASI-746 RIBBON
	830-1645-001	ROCKWELL COLLINS		ASI-74-6C	CABLE: ASI-746 RIBBON
	830-2513-002	ROCKWELL COLLINS		ASI-364	STANDBY INDICATOR PS TEST FIXTURE (FPI-9330/9331)
	830-2523-001	ROCKWELL COLLINS		ASI-15-8B	CABLE: ASI-158 TO BCA-770
	830-2599-001	ROCKWELL COLLINS		ASI-2599-001	EDU TALK OUT TEST FIXTURE
	830-2756-001	ROCKWELL COLLINS		ASI-2756-001	WRT-701X TEST COVER (P/O ASI-7994-701X)
	830-3358-001	ROCKWELL COLLINS		ASI-3358-001	WMA-701/702X SHIMMING PRY TOOL NO 1 (MAN FIG 918)
	830-3359-004	ROCKWELL COLLINS		ASI-763-2	WMA-701/702X SCAN DRIVE GEAR SHIMMING FIXTURE (MAN FIG 921)
	830-3359-005	ROCKWELL COLLINS		ASI-763-1	WMA-701/702X ELEVATION DRIVE GEAR SHIMMING FIXTURE (MAN FIG 920)
	830-3360-001	ROCKWELL COLLINS		ASI-3360-001	WMA-701/702X SHIMMING PRY TOOL NO 2 (MAN FIG 919)
	830-3364-001	ROCKWELL COLLINS		ASI-3364-001	WMA-701/702X SHIMMING PRY TOOL NO 5 (MAN FIG 917)
	830-3829-001	ROCKWELL COLLINS		ASI-3829-001	WMA-701/702X SHIMMING PRY TOOL NO 6 (MAN FIG 915)
	830-3830-001	ROCKWELL COLLINS		ASI-3830-001	WMA-701/702X SHIMMING PRY TOOL NO 7 (MAN FIG 916)
	830-3831-001	ROCKWELL COLLINS		ASI-3831-001	WMA-701/702X AIRBORNE GEAR SHIMMING KIT
	830-3834-001	ROCKWELL COLLINS		ASI-745-1	DLM-900 POWER SUPPLY TEST FIXTURE
	830-3834-002	ROCKWELL COLLINS		ASI-745-2	TTR-920 POWER SUPPLY TEST PANEL (CALL FOR AVAILABILITY)
	830-3834-003	ROCKWELL COLLINS		ASI-745-3	SDU-906 POWER SUPPLY TEST FIXTURE
	830-3835-001	ROCKWELL COLLINS		ASI-74-5A	CABLE: ASI-745-1 TO DLM-900 PWR SUPPLY
	830-3835-002	ROCKWELL COLLINS		ASI-74-5C	CABLE: ASI-745-2 TO TTR-920 POWER SUPPLY
	830-3835-003	ROCKWELL COLLINS		ASI-74-5B	CABLE: ASI-745-3 TO SDU-906 POWER SUPPLY
	830-3915-001	ROCKWELL COLLINS		ASI-356-2	CIU-906 MOUNTING TRAY
	830-4928-001	ROCKWELL COLLINS		ASI-748	DLM-900 LOOPBACK POD
	830-5758-001	ROCKWELL COLLINS		ASI-40-32B1	TORQUE TEST FIXTURE
	830-5758-002	ROCKWELL COLLINS		ASI-40-32B2	SMT SHAFT FREE PLAY FIXTURE
	830-6309-001	ROCKWELL COLLINS		ASI-762	CIU-906 TEST PANEL
	830-6309-009	ROCKWELL COLLINS		ASI-76-2A	CABLE: ASI-762 NO. 1
	830-6309-010	ROCKWELL COLLINS		ASI-76-2B	CABLE: ASI-762 NO. 2
	830-6309-011	ROCKWELL COLLINS		ASI-76-2C	CABLE: ASI-762 NO. 3
	830-6309-012	ROCKWELL COLLINS		ASI-76-2D	CABLE: ASI-762 NO. 4
	830-6309-013	ROCKWELL COLLINS		ASI-76-2E	CABLE: ASI-762 NO. 5
	830-6309-014	ROCKWELL COLLINS		ASI-76-2F	CABLE: ASI-762 NO. 6
	830-6900-002	ROCKWELL COLLINS		ASI-6900-002	CABLE: A51 NOISE DIODE BREAKOUT FOR WRT-701X / WRT-2100
	830-6900-003	ROCKWELL COLLINS		ASI-6900-003	CABLE: A50 SOURCE EXTENDER FOR WRT-701X / WRT-2100
	830-6943-001	ROCKWELL COLLINS		ASI-6943-001	DRIVE EXT CABLE AND CONTROL BOX (WS) (P/O ASI-6960-001)
	830-6944-001	ROCKWELL COLLINS		ASI-6944-001	SEC IF A8 EXT CABLE AND CONTROL BOX (WS) (P/O ASI-6960-001)
	830-6945-001	ROCKWELL COLLINS		ASI-6945-001	NOISE DIODE TEST BOX FOR WRT-701X (WS) (P/O ASI-6960-001)
	830-6946-001	ROCKWELL COLLINS		ASI-6946-001	CABLE: PREDM EXTENDER (P/O ASI-6960-001)
	830-6946-002	ROCKWELL COLLINS		ASI-6946-002	CABLE: MULTIPLIER EXTENDER (P/O ASI-6960-001)
	830-6946-003	ROCKWELL COLLINS		ASI-6946-003	CABLE: MIXER A7 EXTENDER (P/O ASI-6960-001)
	830-6946-004	ROCKWELL COLLINS		ASI-6946-004	CABLE: RF EXTENDER (P/O ASI-6960-001)
	830-6951-001	ROCKWELL COLLINS		ASI-6951-001	TUNING COVER (P/O ASI-6960-001)
	830-6952-001	ROCKWELL COLLINS		ASI-6952-001	TUNING COVER (P/O ASI-6960-001)
	830-6953-001	ROCKWELL COLLINS		ASI-6953-001	TUNING COVER (P/O ASI-6960-001)
	830-6954-001	ROCKWELL COLLINS		ASI-6954-001	TUNING COVER (P/O ASI-6960-001)
	830-6960-001	ROCKWELL COLLINS		ASI-6960-001	WXR FLW RF ALIGNMENT KIT (ALT CPN: 099-4920-000)
	830-6984-001	ROCKWELL COLLINS		ASI-36-4A	PLATE: STANDBY SUPPORT
	830-6984-002	ROCKWELL COLLINS		ASI-36-4B	BLOCK: LCD WEIGHT
	830-7415-101	ROCKWELL COLLINS		ASI-700-4-03	TRANSLATOR TESTER
	830-7424-001	ROCKWELL COLLINS		ASI-7424-001	WRT LO FILTER TEST FIXTURE
	830-7754-001	ROCKWELL COLLINS		ASI-700-4-08	CONTROL BOX ASSEMBLY-BANDSWITCH ADAPTER FOR HFS-700/900
	830-7934-001	ROCKWELL COLLINS		ASI-700-4-04	BLOWER A4A2 TEST FIXTURE
	830-8075-001	ROCKWELL COLLINS		ASI-775	UNIVERSAL POWER SUPPLY TEST PANEL
	830-8361-001	ROCKWELL COLLINS		ASI-8361-001	CMU-900 POWER SUPPLY TESTER
	830-8625-001	ROCKWELL COLLINS		ASI-766	CMU-900 TEST PANEL
	856-8022-010	ROCKWELL COLLINS		ASI-SDU-906	SDU-906 TEST EQUIPMENT KIT
	856-8022-020	ROCKWELL COLLINS		ASI-746-2	SDU-906 RAM BUFFER CARD
	856-8022-060	ROCKWELL COLLINS		ASI-749	SDU-906 SYSTEM PROCESSOR TEST SET
	856-8022-070	ROCKWELL COLLINS		ASI-751	SDU-906 MAIN UNIT TEST SET
	856-8022-080	ROCKWELL COLLINS		ASI-754	SDU-906 CHANNEL MODULE ADAPTER
	856-8022-090	ROCKWELL COLLINS		ASI-755	SDU-906 CEPT ADAPTER TEST FIXTURE
	856-8022-100	ROCKWELL COLLINS		ASI-756	SDU-906 429 ADAPTER TEST MODULE
	856-8022-140	ROCKWELL COLLINS		ASI-747	BUS BUFFER CARD
	902-40-1	ROCKWELL COLLINS		ASI-811-3	TEST SET FOR 902-1 (AIRSHOW / CABIN SYSTEMS)
	930005-101	ROCKWELL COLLINS		ASI-930005-101	ALIGNMENT TOOL FOR DBS2100 ASTV (INCL 2 DIGITAL PROTRACTORS)
	931101-100-1	ROCKWELL COLLINS		ASI-931101-100-1	RDU BREAKOUT BOX
	931407-100	ROCKWELL COLLINS		ASI-931407-100	CABLE: RDU CONFIGURATION ADAPTER
	932400-105-1	ROCKWELL COLLINS		ASI-932400-105-1	CABLE: GEM-P4 TP SSP-P3
	932400-105-2	ROCKWELL COLLINS		ASI-932400-105-2	CABLE: TMU-P1 TO GEM-P1
	932500-101	ROCKWELL COLLINS		ASI-CTS-976	LOCAL PANEL
	932500-400-W1	ROCKWELL COLLINS		ASI-97-6A	CABLE: ASI-CTS-976 W1
	932500-400-W16	ROCKWELL COLLINS		ASI-97-6C	CABLE: ASI-CTS-976 W16
	932500-400-W31	ROCKWELL COLLINS		ASI-97-6D	CABLE: ASI-CTS-976 W31

OEM TO ASI EQUIVALENT CROSS REFERENCE

EQUIV MN	EQUIV PN	EQUIV OEM	JC-AIR PN	ASI MN	DESCRIPTION
	932500-400-W4	ROCKWELL COLLINS		ASI-97-6B	CABLE: ASI-CTS-976 W4
	933428-100	ROCKWELL COLLINS		ASI-933428-100	CABLE: IRDM
	933436-100	ROCKWELL COLLINS		ASI-933436-100	CABLE: IR INTERFACE DONGLE
	949F859-1	HONEYWELL		ASI-335	GENERATOR TESTER
	964-4922-001	ROCKWELL COLLINS		ASI-4922-001	RTA-4XXX WW-MAP LOAD BOX
	983-4287-054	ROCKWELL COLLINS		ASI-4287-054	ZERO SENSOR HOUSING TEST COVER
	983-4287-201	ROCKWELL COLLINS		ASI-4287-201	ZERO MON CAL FIXTURE
	983-4287-202	ROCKWELL COLLINS		ASI-4287-202	CABLE: ZERO SENSOR
	983-4287-203	ROCKWELL COLLINS		ASI-4287-203	WMA INCLIMOMETER / COUNTERWEIGHT ASSEMBLY
	983-4287-205	ROCKWELL COLLINS		ASI-4287-205	CABLE: SCAN ZERO SENSOR
	983-4667-001	ROCKWELL COLLINS		ASI-4667-001	CABLE: RF
	983-4904-001	ROCKWELL COLLINS		ASI-700-4-01	OSCILLOSCOPE LOGIC PROBE
	983-4924-001	ROCKWELL COLLINS		ASI-700-4-02	POWER SUPPLY LOAD TEST FIXTURE
	983-8108-001	ROCKWELL COLLINS		ASI-900-1	GPS TIME MARK ASSY FOR TDR-94/94D
	983-8108-005	ROCKWELL COLLINS		ASI-900-2	GPS TIME MARK ASSY FOR CISS
	987-0007-767	ROCKWELL COLLINS		ASI-777-61	HF-9000 LOWPASS FILTER TEST FIXTURE
	987-0007-768	ROCKWELL COLLINS		ASI-777-71	HF-9087F AUDIO I/O TEST FIXTURE
	987-0007-786	ROCKWELL COLLINS		ASI-777-81	HF-9000 POWER AMPLIFIER TEST PANEL
	987-0007-787	ROCKWELL COLLINS		ASI-777-82	HF-9000 BLOWER FIXTURE
	987-0018-001	ROCKWELL COLLINS		ASI-777-7	HF-9087D AUDIO I/O TEST FIXTURE
	987-0788-001	ROCKWELL COLLINS		ASI-0788-001	TEST SET
	987-0896-001	ROCKWELL COLLINS		ASI-0896-001	CABLE: ELECTRICAL POWER
	987-0897-001	ROCKWELL COLLINS		ASI-0897-001	CABLE: UUT
	987-1253-001	ROCKWELL COLLINS		ASI-1253-001	CABLE: RS-232
	987-1254-001	ROCKWELL COLLINS		ASI-1254-001	CABLE: RS-422
	987-1374-030	ROCKWELL COLLINS		ASI-1374-030	RESOURCE PANEL TEST CABLE: CDU-7000
	987-1374-040	ROCKWELL COLLINS		ASI-1374-040	RESOURCE PANEL TEST CABLE
	987-1374-050	ROCKWELL COLLINS		ASI-1374-050	RESOURCE PANEL TEST CABLE
	987-1374-060	ROCKWELL COLLINS		ASI-1374-060	RESOURCE PANEL TEST CABLE
	987-1374-070	ROCKWELL COLLINS		ASI-1374-070	RESOURCE PANEL TEST CABLE
	987-1374-075	ROCKWELL COLLINS		ASI-1374-075	RESOURCE PANEL TEST CABLE
	987-1374-078	ROCKWELL COLLINS		ASI-1374-078	RESOURCE PANEL TEST CABLE
	987-2013-002	ROCKWELL COLLINS		ASI-2013-002	CABLE: ITA W2
	987-2013-008	ROCKWELL COLLINS		ASI-2013-008	CABLE: ITA W8
	987-2013-010	ROCKWELL COLLINS		ASI-2013-010	CABLE: ITA W10
	987-2013-012	ROCKWELL COLLINS		ASI-2013-012	CABLE: ITA W12
	987-2013-034	ROCKWELL COLLINS		ASI-2013-034	CABLE: ITA W38
	987-2587-001	ROCKWELL COLLINS		ASI-2587-001	MFD-286P ADAPTER CABLE
	987-6695-050	ROCKWELL COLLINS		ASI-6695-050	CABLE: ELECTRICAL INTERFACE
	987-6695-051	ROCKWELL COLLINS		ASI-6695-051	CABLE: ELECTRICAL INTERFACE
	988-3056-001	ROCKWELL COLLINS		ASI-3056-001	COAX CABLE ASSY
	988-5561-001	ROCKWELL COLLINS		ASI-20-74A	CABLE: ASI-207-4 (967R-2) SPECIAL PURPOSE
	988-5562-001	ROCKWELL COLLINS		ASI-20-74B	CABLE: ASI-207-4 (967R-2) SPECIAL PURPOSE
	988-5563-001	ROCKWELL COLLINS		ASI-20-74C	CABLE: ASI-207-4 (967R-2) SPECIAL PURPOSE
	988-5564-001	ROCKWELL COLLINS		ASI-20-74D	CABLE: ASI-207-4 (967R-2) SPECIAL PURPOSE
	988-5565-001	ROCKWELL COLLINS		ASI-20-74E	CABLE: ASI-207-4 (967R-2) SPECIAL PURPOSE
	988-5566-001	ROCKWELL COLLINS		ASI-20-74F	CABLE: ASI-207-4 (967R-2) SPECIAL PURPOSE
	988-5567-001	ROCKWELL COLLINS		ASI-20-74G	CABLE: ASI-207-4 (967R-2) SPECIAL PURPOSE
	988-5567-002	ROCKWELL COLLINS		ASI-20-74G1	CABLE: ASI-207-4 (967R-2) SPECIAL PURPOSE
	988-5568-001	ROCKWELL COLLINS		ASI-20-74H	CABLE: ASI-207-4 (967R-2) SPECIAL PURPOSE
	988-5569-001	ROCKWELL COLLINS		ASI-20-74J	CABLE: ASI-207-4 (967R-2) SPECIAL PURPOSE
	988-5570-001	ROCKWELL COLLINS		ASI-20-74K	CABLE: ASI-207-4 (967R-2) SPECIAL PURPOSE
	988-5571-001	ROCKWELL COLLINS		ASI-20-74L	CABLE: ASI-207-4 (967R-2) SPECIAL PURPOSE
	988-5572-001	ROCKWELL COLLINS		ASI-20-74M1	CABLE: ASI-207-4 (967R-2) SPECIAL PURPOSE
	988-5572-002	ROCKWELL COLLINS		ASI-20-74M2	CABLE: ASI-207-4 (967R-2) SPECIAL PURPOSE
	988-8192-001	ROCKWELL COLLINS		ASI-60-33A	CABLE: ASI-603-3 (964B-3) SPECIAL PURPOSE
	988-8193-001	ROCKWELL COLLINS		ASI-60-33B	CABLE: ASI-603-3 (964B-3) SPECIAL PURPOSE
	988-9194-001	ROCKWELL COLLINS		ASI-60-33C	CABLE: ASI-603-3 (964B-3) SPECIAL PURPOSE
	988-9276-001	ROCKWELL COLLINS		ASI-9276-001	CABLE: MFD-255E BURN IN, TURKEY-PHENIX
	988-9774-001	ROCKWELL COLLINS		ASI-77-7A	CABLE: ASI-777 (TE-9210) W1
	988-9775-001	ROCKWELL COLLINS		ASI-77-7B	CABLE: ASI-777 (TE-9210) W2
	988-9776-001	ROCKWELL COLLINS		ASI-77-7C	CABLE: ASI-777 (TE-9210) W3
	988-9777-001	ROCKWELL COLLINS		ASI-77-7D	CABLE: ASI-777 (TE-9210) W4
	988-9778-001	ROCKWELL COLLINS		ASI-77-7E	CABLE: ASI-777 (TE-9210) W5
	988-9779-001	ROCKWELL COLLINS		ASI-77-7F	CABLE: ASI-777 (TE-9210) W6
	989-2146-001	ROCKWELL COLLINS		ASI-207-10	CPL-920D 90 DEGREE PHASE SHIFT NETWORK
	989-2146-002	ROCKWELL COLLINS		ASI-207-11	CPL-920D 0 DEGREE PHASE DIVIDER
	989-2146-007	ROCKWELL COLLINS		ASI-207-12	CPL-920D RF TEST CABLE (2 REQUIRED)
	989-2159-001	ROCKWELL COLLINS		ASI-207-6	CPL-920D MIMS/ DISCRIMINATOR TEST FIXTURE (TE2)
	989-2159-006	ROCKWELL COLLINS		ASI-207-6-1	CPL-920D MIMS/SENSOR ASSY TOP TEST COVER (P/O ASI-207-6)
	989-2159-007	ROCKWELL COLLINS		ASI-207-6-2	CPL-920D MIMS/SENSOR ASSY TEST COIL TOP COVER (P/O ASI-207-6)
	989-2159-008	ROCKWELL COLLINS		ASI-207-6-3	CPL-920D MIMS/SENSOR ASSY BOTTOM TEST COVER (P/O ASI-207-6)
	989-2159-011	ROCKWELL COLLINS		ASI-207-6-4	CPL-920D SMB COAX TEST JUMPER (P/O ASI-207-6)
	989-2159-012	ROCKWELL COLLINS		ASI-207-6-5	CPL-920D SMB COAX TEST JUMPER (P/O ASI-207-6)
	989-2167-001	ROCKWELL COLLINS		ASI-207-7	CPL-920D RF NETWORK TEST FIXTURE (TE3)
	989-2168-001	ROCKWELL COLLINS		ASI-207-8	CPL-920D RF NETWORK HOLDING FIXTURE (TE4)
	989-2168-009	ROCKWELL COLLINS		ASI-207-8-1	CPL-920D RF TEST CABLE (P/O ASI-207-8)
	989-2168-010	ROCKWELL COLLINS		ASI-207-8-2	CPL-920D RF TEST CABLE (P/O ASI-207-8)
	989-2169-001	ROCKWELL COLLINS		ASI-207-9	CPL-920D CALIBRATION FIXTURE (TE5)
	ES1202683-15	LOCKHEED		ASI-ES1202683-15	C130 CARD EXTENDER
	ES120665-43	LOCKHEED		ASI-ES120665-43	C130 SENSOR
	ES120666-13	LOCKHEED		ASI-ES120666-13	C130 TORQUE METER CABLE
	ES120666-65	LOCKHEED		ASI-ES120666-65	C130 TACHOMETER CABLE
	ES120666-9	LOCKHEED		ASI-ES120666-9	C130 FUEL FLOW CABLE
	GSE601303-001	EATON AEROSPACE		ASI-1010-1	INTERFACE CONTROL PANEL

OEM TO ASI EQUIVALENT CROSS REFERENCE

EQUIV MN	EQUIV PN	EQUIV OEM	JC-AIR PN	ASI MN	DESCRIPTION
	GSE601303-001	EATON AEROSPACE		ASI-1010-2	INTERFACE CONTROL PANEL (KLM MOD OF ASI-10101-1)
	HT/100E-32K	ROCKWELL COLLINS		ASI-8268-DLC	DLC-800() DUMB TERMINAL (HANDHELD)
	MI-592186	HONEYWELL (RCA)		ASI-270-4	AVQ-30 RADAR R-T TEST PANEL
	MI-592187	HONEYWELL (RCA)		ASI-270-3	AVQ-30 RADAR INDICATOR TEST PANEL
	MI-592188	HONEYWELL (RCA)		ASI-270-2	AVQ-30 RADAR ANTENNA TEST PANEL
	MI-592189	HONEYWELL (RCA)		ASI-270-1	AVQ-30 RADAR RT MODULE TEST PANEL
	NYLZ-52238	SMITHS		ASI-1032-1	WINDOW DEFOG CONTROLLER TEST FIXTURE FOR SYLZ-5185
	NYLZ-52239	SMITHS		ASI-1032-2	WINDOW DEFOG CONTROLLER TEST FIXTURE FOR SYLZ-5185
	PRO-360	MITUTOYO		ASI-PRO-360	DIGITAL PROTRACTER / LEVEL (ACCURACY +/-0.1 DEGREES)
	PRO-3600	MITUTOYO		ASI-PRO-3600	DIGITAL PROTRACTER / LEVEL WITH RS-232 OUTPUT (+/-0.05 DEGREES)
	PRO-3600 CABLE	MITUTOYO		ASI-PRO-3600-CBL	RS-232 CABLE AND FOOT SWITCH FOR ASI-PRE-3600 (PRO-3600)
	RX1-LM	GULL		ASI-RX1-LM	TEST ADAPTER FOR GTF-1, GTF-2, GTF-6, GTF-10
	T3000626	HONEYWELL (SPERRY)		ASI-26-02F	HOLDING FIXTURE
	T3008089	HONEYWELL (SPERRY)		ASI-27-5V	DIAL INDICATING MOUNTING ADAPTER
	T3009296	HONEYWELL (SPERRY)		ASI-26-01V	OFFSET WRENCH
	T3009480	HONEYWELL (SPERRY)	01-0334-00	ASI-27-5X	TEST WEIGHT
	T3012026	HONEYWELL (SPERRY)		ASI-26-01L	SYNCHRO CEMENTING FIXTURE
	T3012027	HONEYWELL (SPERRY)		ASI-26-01M	SLIP RING ALIGNMENT FIXTURE
	T3012029	HONEYWELL (SPERRY)		ASI-26-01N	SLIP RING ALIGNMENT TOOL
	T3012040	HONEYWELL (SPERRY)		ASI-26-01K	SYNCHRO ALIGNMENT BLOCK
	T3012042	HONEYWELL (SPERRY)		ASI-26-01Z	ALIGNMENT PLATE
	T3012050	HONEYWELL (SPERRY)		ASI-26-01P	ROTOR SHIMMING FIXTURE
	T3012051	HONEYWELL (SPERRY)		ASI-26-02E	GIMBAL SHIMMING STEP PLUG
	T3012054	HONEYWELL (SPERRY)		ASI-26-01W	ROTOR BALANCE ADAPTER SET
	T3012055	HONEYWELL (SPERRY)		ASI-26-01F	HOLDING FIXTURE
	T3012061-A	HONEYWELL (SPERRY)		ASI-27-5C1	ROTOR CLAMP A
	T3012061-B	HONEYWELL (SPERRY)		ASI-27-5C2	ROTOR CLAMP B
	T3012062	HONEYWELL (SPERRY)		ASI-26-01S	ANVIL
	T3012066	HONEYWELL (SPERRY)		ASI-27-5D	ROTOR ASSEMBLY BUSHING
	T3012066	HONEYWELL (SPERRY)		ASI-26-01R	ROTOR ASSEMBLY BUSHING (SAME AS ASI-27-5D)
	T3012067	HONEYWELL (SPERRY)		ASI-26-01G	SLIP RING GUARD
	T3012074	HONEYWELL (SPERRY)		ASI-26-01J	HEMISPHERE ALIGNING FIXTURE
	T3012469	HONEYWELL (SPERRY)		ASI-26-01T	ADAPTER SET
	T3013063	HONEYWELL (SPERRY)		ASI-26-01Q	BRAKE SHIMMING FIXTURE
	T3013271	HONEYWELL (SPERRY)		ASI-26-02J	SPACER BLOCK
	T3017560	HONEYWELL (SPERRY)		ASI-26-01Y	BALANCE WEIGHT
	T3075022	HONEYWELL (SPERRY)		ASI-27-5F	BEARING PARALLEL CHECKING TOOL
	T307520-201	HONEYWELL (SPERRY)		ASI-453	SERVO AMPLIFIER TEST FIXTURE
	T307527-201	HONEYWELL (SPERRY)		ASI-454-1	CONTROL PANEL TEST FIXTURE
	T307527-202	HONEYWELL (SPERRY)		ASI-454-2	CONTROL PANEL TEST FIXTURE
	T307531-201	HONEYWELL (SPERRY)		ASI-455	YAW SYNCHRONIZER TEST FIXTURE
	T307533-201	HONEYWELL (SPERRY)		ASI-456	AIR DATA SENSOR TEST FIXTURE
	T307534-201	HONEYWELL (SPERRY)		ASI-457	ALTITUDE SIGNAL COUPLER TEST FIXTURE
	T307535-201	HONEYWELL (SPERRY)		ASI-458-1	PITCH COMPUTER TEST FIXTURE
	T307535-202	HONEYWELL (SPERRY)		ASI-458-2	PITCH COMPUTER TEST FIXTURE
	T307535-300	HONEYWELL (SPERRY)		ASI-458-3	PITCH COMPUTER TEST ADAPTER
	T307535-310	HONEYWELL (SPERRY)		ASI-458-4	PITCH COMPUTER TEST ADAPTER
	T307536-201	HONEYWELL (SPERRY)		ASI-459-1	LATERAL PATH COUPLER TEST FIXTURE
	T307536-202	HONEYWELL (SPERRY)		ASI-459-2	LATERAL PATH COUPLER TEST FIXTURE
	T307545-201	HONEYWELL (SPERRY)		ASI-460-1	PITCH CONTROL CHANNEL TEST FIXTURE
	T307545-202	HONEYWELL (SPERRY)		ASI-460-2	PITCH CONTROL CHANNEL TEST FIXTURE
	T307545-401	HONEYWELL (SPERRY)		ASI-460-3	PITCH CONTROL CHANNEL ADAPTER
	T307547-201	HONEYWELL (SPERRY)		ASI-461-1	ROLL CONTROL CHANNEL TEST FIXTURE
	T307547-202	HONEYWELL (SPERRY)		ASI-461-2	ROLL CONTROL CHANNEL TEST FIXTURE
	T307547-401	HONEYWELL (SPERRY)		ASI-461-3	ROLL CONTROL CHANNEL ADAPTER
	T307550-201	HONEYWELL (SPERRY)		ASI-462	POSITION SENSOR TEST FIXTURE
	T307554-201	HONEYWELL (SPERRY)		ASI-463-1	YAW DAMPER COUPLER TEST FIXTURE
	T307554-202	HONEYWELL (SPERRY)		ASI-463-2	YAW DAMPER COUPLER TEST FIXTURE
	T307554-401	HONEYWELL (SPERRY)		ASI-463-3	YAW DAMPER COUPLER ADAPTER
	T307555-201	HONEYWELL (SPERRY)		ASI-464-1	TRIM COUPLER TEST FIXTURE
	T307555-202	HONEYWELL (SPERRY)		ASI-464-2	TRIM COUPLER TEST FIXTURE
	T307563-201	HONEYWELL (SPERRY)		ASI-465	HEADING SYNCHRONIZER TEST FIXTURE
	T307571-201	HONEYWELL (SPERRY)		ASI-466-1	VERTICAL PATH COUPLER TEST FIXTURE
	T307571-202	HONEYWELL (SPERRY)		ASI-466-2	VERTICAL PATH COUPLER TEST FIXTURE
	T307573-201	HONEYWELL (SPERRY)		ASI-467-1	ROLL COMPUTER TEST FIXTURE
	T307573-202	HONEYWELL (SPERRY)		ASI-467-2	ROLL COMPUTER TEST FIXTURE
	T307574-201	HONEYWELL (SPERRY)		ASI-468	Q SENSOR TEST FIXTURE
	T307702-4	HONEYWELL (SPERRY)		ASI-407-1	POWER SUPPLY AND READOUT
	T307724-201	HONEYWELL (SPERRY)		ASI-470	VERTICAL SPEED PITCH CONTROL TEST FIXTURE
	T307846-902	HONEYWELL (SPERRY)		ASI-471	VERTICAL GYRO TEST FIXTURE
	T307875	HONEYWELL (SPERRY)		ASI-472	FAILURE WARNING MONITOR TEST FIXTURE
	T307950	HONEYWELL (SPERRY)		ASI-473	RATE OF TURN RACK TEST FIXTURE
	T307951	HONEYWELL (SPERRY)		ASI-450	UNIVERSAL POINTER/FLAG TEST FIXTURE
	T307962	HONEYWELL (SPERRY)		ASI-451-1	UNIVERSAL INSTRUMENT SERVO TEST FIXTURE
	T307962-425	HONEYWELL (SPERRY)		ASI-451-2	FUNCTION TEST SET FOR C6
	T307965	HONEYWELL (SPERRY)		ASI-491	RATE OF TURN RACK MOUNTING FIXTURE
	T307967	HONEYWELL (SPERRY)		ASI-410	C-14 FLUX VALVE HEADING SIMULATOR
	T307972	HONEYWELL (SPERRY)		ASI-27-5B	SCORSBY ADAPTER PLATE
	T307976	HONEYWELL (SPERRY)		ASI-275-1	DG-401 PRELIMINARY AND C14FINAL TEST FIXTURE
	T307977	HONEYWELL (SPERRY)		ASI-275-2	DG-401 CALIBRATION FIXTURE
	T321019-201	HONEYWELL (SPERRY)		ASI-474-1	CONTROL PANEL TEST FIXTURE
	T321019-202	HONEYWELL (SPERRY)		ASI-474-2	CONTROL PANEL TEST FIXTURE
	T321019-301	HONEYWELL (SPERRY)		ASI-474-3	TEST ADAPTER PANEL
	T321019-401	HONEYWELL (SPERRY)		ASI-474-4	TEST ADAPTER PANEL
	T321019-404	HONEYWELL (SPERRY)		ASI-474-5	TEST ADAPTER PANEL

OEM TO ASI EQUIVALENT CROSS REFERENCE

EQUIV MN	EQUIV PN	EQUIV OEM	JC-AIR PN	ASI MN	DESCRIPTION
	T321019-405	HONEYWELL (SPERRY)		ASI-474-6	TEST ADAPTER PANEL
	T321116-201	HONEYWELL (SPERRY)		ASI-475	PITCH CONTROL CHANNEL TEST FIXTURE
	T321121-201	HONEYWELL (SPERRY)		ASI-476	ROLL CONTROL CHANNEL TEST FIXTURE
	T321241-201	HONEYWELL (SPERRY)		ASI-477	MACH TRIM COUPLER TEST FIXTURE
	T321272-901	HONEYWELL (SPERRY)		ASI-407-2	API LATCHING FIXTURE
	T321352	HONEYWELL (SPERRY)		ASI-478	AUTOMATIC STABILIZER TRIM UNIT TEST FIXTURE
	T321355-1	HONEYWELL (SPERRY)		ASI-479-1	UNIVERSAL COUNTER FOR USE WITH VG-321 TEST FIXTURE (P/O ASI-479)
	T321356	HONEYWELL (SPERRY)		ASI-479	VG-321 TEST FIXTURE
	T321356-2	HONEYWELL (SPERRY)		ASI-479-2	VG-321 TEST FIXTURE SET (INCLUDES ASI-479-1/-2/-3)
	T321356-3	HONEYWELL (SPERRY)		ASI-479-3	FREQ MONITOR PU CABLE FOR VG-321 TEST FIXTURE (P/O ASI-479) W5
	T321372	HONEYWELL (SPERRY)		ASI-480	MONITOR AND LOGIC UNIT TEST FIXTURE
	T321670	HONEYWELL (SPERRY)		ASI-481	CONTROLLER TEST FIXTURE WITH 10 CABLES
	T321677	HONEYWELL (SPERRY)		ASI-26-01D	INDEXING TURNTABLE
	T321686	HONEYWELL (SPERRY)		ASI-26-01E	VG-401 HOLDING FIXTURE
	T321693	HONEYWELL (SPERRY)		ASI-493	CS-412 COMPENSATOR TEST HARNESS
	T321703	HONEYWELL (SPERRY)		ASI-260-1	TARSYN/VG-14 FINAL TEST FIXTURE
	T321703-49	HONEYWELL (SPERRY)		ASI-26-01A	CABLE: ASI-260-1 PWR (W1)
	T321703-50	HONEYWELL (SPERRY)		ASI-26-01B	CABLE: ASI-260-1 (T321703) TO UUT (W2)
	T321703-51	HONEYWELL (SPERRY)		ASI-26-01C	CABLE: ASI-260-1 (T321703) TO UUT (W3)
	T321705	HONEYWELL (SPERRY)		ASI-260-2	TARSYN/VG-14 FIELD TEST FIXTURE
	T321705-49	HONEYWELL (SPERRY)		ASI-26-02A	CABLE: ASI-260-2 PWR (W1)
	T321705-50	HONEYWELL (SPERRY)		ASI-26-02B	CABLE: ASI-260-2 (T321705) TO UUT (W2)
	T321705-51	HONEYWELL (SPERRY)		ASI-26-02C	CABLE: ASI-260-2 (T321705) TO UUT (W3)
	T321746	HONEYWELL (SPERRY)		ASI-350-1	COMPARISON FLUX VALVE TEST FIXTURE
	T321989	HONEYWELL (SPERRY)		ASI-482	DIGITAL ALTIMETER TEST FIXTURE
	T322029	HONEYWELL (SPERRY)		ASI-483	RECEIVER TRANSMITTER TEST FIXTURE
	T322695	HONEYWELL (SPERRY)		ASI-411-1	VG-401 TEST FIXTURE
	T322710	HONEYWELL (SPERRY)		ASI-26-02L	NUT COVER TIGHTENING TOOL
	T322745-1	HONEYWELL (SPERRY)		ASI-27-5A1	CABLE: ASI-275-1 TO C-14 GYRO SYNCHRONIZER (PN 4019190-1 THRU -7)
	T322745-2	HONEYWELL (SPERRY)		ASI-27-5A2	CABLE: ASI-275-1 TO C-14 GYRO SYNCHRONIZER (PN 4019190-13/-16/-18)
	T322771	HONEYWELL (SPERRY)		ASI-27-5A3	CABLE: ASI-275-1 TO C-14 GYRO SYNCHRONIZER (PN 4019190-13/-16)
	T322780	HONEYWELL (SPERRY)		ASI-409	C-14 AMPLIFIER/SYNCHRONIZER TEST FIXTURE
	T322861	HONEYWELL (SPERRY)		ASI-408	C-14D BASE TEST FIXTURE
	T322870	HONEYWELL (SPERRY)		ASI-27-5A4	CABLE: ASI-275-1 (T307976) TO C-14D GYRO (PN 4020577-VAR)
	T322880	HONEYWELL (SPERRY)		ASI-411-2	TARSYN-H / VG-14H BASE TEST FIXTURE
	T322896	HONEYWELL (SPERRY)		ASI-26-02K	BASE HOLDING FIXTURE
	T322967	HONEYWELL (SPERRY)		ASI-492-1	RADIO ALTIMETER TEST SET
	T323177	HONEYWELL (SPERRY)		ASI-484	TEST CABLE
	T323206	HONEYWELL (SPERRY)		ASI-485	DC-9/10 TRC POWER SUPPLY TEST FIXTURE
	T323687-201	HONEYWELL (SPERRY)		ASI-486	ROLL AUTOLAND TEST FIXTURE
	T323689-201	HONEYWELL (SPERRY)		ASI-487	PITCH AUTOLAND TEST FIXTURE
	T323689-202	HONEYWELL (SPERRY)		ASI-489	PITCH AUTOLAND TEST FIXTURE
	T325144	HONEYWELL (SPERRY)		ASI-490	AUTOMATIC STABILIZER TRIM UNIT TEST FIXTURE ADAPTER
	T334109	HONEYWELL (SPERRY)		ASI-492-2	RT-300 TEST FIXTURE ADAPTER
	T334822	HONEYWELL (SPERRY)		ASI-264	WC-874 EFIS AUX. CONN TEST BOX
	T450-100-TB1	KAISER AEROSPACE		ASI-T450-100-TB1	SWITCH TESTER FOR LANDING GEAR (450-100) AND FIRE CTL(450-300)
	T450-100-TS	KAISER AEROSPACE		ASI-T450-100-TS	TEST STAND (INCLUDED WITH ASI-T450-100-TB1)
	T626912	HONEYWELL (SPERRY)		ASI-26-02H	GIMBAL BALANCING FIXTURE
	T674655	HONEYWELL (SPERRY)		ASI-26-01X	STATIC BALANCE FIXTURE
	T675344	HONEYWELL (SPERRY)		ASI-26-01U	TORQUE NUT DRIVER
	T891970	HONEYWELL (SPERRY)		ASI-27-5I	BEARING PRELOAD FIXTURE
	T893165	HONEYWELL (SPERRY)		ASI-26-01H	BRUSH GUARD
	T896276	HONEYWELL (SPERRY)		ASI-27-5K	ROTOR BALANCING CRADLE
	T896405	HONEYWELL (SPERRY)		ASI-27-5Y	PUNCH AND ANVIL
	T896455	HONEYWELL (SPERRY)		ASI-27-5P	MAGNET CEMENTING FIXTURE
	T896496	HONEYWELL (SPERRY)		ASI-27-5W	STATOR LOC. AND CEMENTING FIXTURE
	T896497	HONEYWELL (SPERRY)		ASI-27-5J	ROTOR BALANCING ADAPTERS
	T896499	HONEYWELL (SPERRY)		ASI-27-5Z	PRESSING TOOL
	T896500	HONEYWELL (SPERRY)		ASI-27-5H	BEARING PRELOAD ADAPTER SET
	T896598	HONEYWELL (SPERRY)		ASI-27-5U	GIMBAL ASSEMBLY BALANCE FIXTURE
	T896625	HONEYWELL (SPERRY)		ASI-27-5N	SWITCH RING ALIGNMENT FIXTURE
	T896773	HONEYWELL (SPERRY)		ASI-27-5R	SLIPRING ALIGNING AND CEMENTING TOOL
	T896871	HONEYWELL (SPERRY)		ASI-27-5S	SLIPRING PROTECTOR
	T897024	HONEYWELL (SPERRY)		ASI-27-5L	TERMINAL INSERTER
	T897167	HONEYWELL (SPERRY)		ASI-27-5Q	STATIC BALANCE FIXTURE
	T897177	HONEYWELL (SPERRY)		ASI-26-02D	RUN-OUT FIXTURE
	T897413	HONEYWELL (SPERRY)		ASI-27-5M	SLIPRING CEMENTING CLAMPS
	T897487	HONEYWELL (SPERRY)		ASI-27-5E	HEIGHT DIMENSION GAUGE
	T898023	HONEYWELL (SPERRY)		ASI-27-5T	DIAL INDICATOR MOUNTING ADAPTER
	T898487	HONEYWELL (SPERRY)		ASI-27-5G	OPEN END WRENCH
	T898656	HONEYWELL (SPERRY)		ASI-26-02G	DIAL INDICATOR POST
	TP6-1146-011	ROCKWELL COLLINS		ASI-33-83L	ATM-200 BREAKOUT CABLE
	TP6-2800-013	ROCKWELL COLLINS		ASI-33-85D	CABLE: SELCAL WIRING CHECK ADAPTER
	TP6-3955-013-1	ROCKWELL COLLINS		ASI-33-81F	CABLE: CTL-230
	TSH-4D	FLITEFONE		ASI-273	FLITEFONE TEST SET
	TS-PC15-1	MARATHON		ASI-818-1	TEST SET FOR PC-15 / PC-15A
	TS-PC17-1	MARATHON		ASI-818-2	TEST SET FOR PC-17 / PC-17A
	TT-1241	HONEYWELL (BENDIX)		ASI-19-9K	ALA-51A STRIPLINE TEST ADAPTER
	TT-3-2037042	HONEYWELL (BENDIX)		ASI-19-9L	ALA-51A CENTER CONDUCTOR ALIGNMENT TOOL
	TT-6-2037042	HONEYWELL (BENDIX)		ASI-19-9M	ALA-51A CENTER CONDUCTOR ALIGNMENT RING
	UG2293AA01	HONEYWELL (SPERRY)		ASI-796-1	TOTALIZING INDICATOR TEST SET
	UG2293AA02	HONEYWELL (SPERRY)		ASI-796-2	TOTALIZING INDICATOR TEST SET
	UG2559AB	HONEYWELL (SPERRY)		ASI-332	RADAR ALTIMETER SYSTEM TESTER (TESTS YG-7500 / 7600)
	UG2926AA	HONEYWELL (SPERRY)		ASI-333	CALIBRATION UNIT PANEL (TESTS HG7502BC02/03/04)
	WB-1	FLITEFONE		ASI-274	FLITEFONE AUXILIARY BELL ASSEMBLY

OEM TO ASI EQUIVALENT CROSS REFERENCE

<u>EQUIV MN</u>	<u>EQUIV PN</u>	<u>EQUIV OEM</u>	<u>JC-AIR PN</u>	<u>ASI MN</u>	<u>DESCRIPTION</u>
-----------------	-----------------	------------------	------------------	---------------	--------------------

ASI TEST EQUIPMENT UNIT UNDER TEST (UUT) CROSS REFERENCE

UNIT TESTED	ASI MN	EQUIV MN	EQUIV PN	EQUIV OEM	DESCRIPTION
1051B-1	ASI-161	479V-3	522-1339-000	ROCKWELL COLLINS	PRECISION TRACK SELECTOR
1051B-1	ASI-327-3	977C-1	777-1358-001	ROCKWELL COLLINS	51RV-2B CARD TEST PANEL
147B-2	ASI-406	NMN	NPN	ROCKWELL COLLINS	TEST PANEL
161E-1	ASI-40Y-7	440Y-7	522-4944-001	ROCKWELL COLLINS	980L-1 PLUG-IN ADAPTER
161E-2	ASI-40Y-20	440Y-20	777-1039-001	ROCKWELL COLLINS	980L-1 PLUG-IN ADAPTER
161E-2A	ASI-183-1	971F-1	622-2013-002	ROCKWELL COLLINS	FCS-105 AUTOPILOT TEST SET
161E-2A	ASI-40Y-39	440Y-39	792-6384-001	ROCKWELL COLLINS	980L-1 PLUG-IN ADAPTER
161E-6	ASI-40Y-30	440Y-30	787-6139-001	ROCKWELL COLLINS	980L-1 PLUG-IN ADAPTER
161E-7A	ASI-40Y-26	440Y-26	777-1919-001	ROCKWELL COLLINS	980L-1 PLUG-IN ADAPTER
161E-7B	ASI-40Y-35	440Y-35	787-6144-001	ROCKWELL COLLINS	980L-1 PLUG-IN ADAPTER/SERVO UNIT
161F-1	ASI-40Y-11	440Y-11	522-4960-001	ROCKWELL COLLINS	980L-1 PLUG-IN ADAPTER
161F-1A	ASI-40Y-11	440Y-11	522-4960-001	ROCKWELL COLLINS	980L-1 PLUG-IN ADAPTER
161F-1B	ASI-40Y-11	440Y-11	522-4960-001	ROCKWELL COLLINS	980L-1 PLUG-IN ADAPTER
161F-1C	ASI-40Y-11	440Y-11	522-4960-001	ROCKWELL COLLINS	980L-1 PLUG-IN ADAPTER
161H-1	ASI-204	972S-1	622-1626-001	ROCKWELL COLLINS	AUTOPILOT RAMP TEST SET
161H-1	ASI-205	972S-2	622-1628-001	ROCKWELL COLLINS	AUTOPILOT BENCH TEST SET
161H-1	ASI-CTS-10	CTS-10	622-4561-00	ROCKWELL COLLINS	UNIVERSAL ATR BREAKOUT BOX
179L-1	ASI-192	477U-2	522-2710-000	ROCKWELL COLLINS	ADF ANTENNA SIMULATOR
180R-4/4A	ASI-346	980H-3	522-4748-001	ROCKWELL COLLINS	ANTENNA COUPLER TEST SET
180R-4/6/7/8/10	ASI-329-2	172H-1	522-1708-000	ROCKWELL COLLINS	DUMMY COMPOSITE ANTENNA
180R-4/6/7/8/10	ASI-329-13	172H-26	622-5605-001	ROCKWELL COLLINS	ELECTRICAL DUMMY LOAD
180R-6/6A	ASI-329-10	172H-10	522-4601-001	ROCKWELL COLLINS	ELECTRICAL DUMMY LOAD
180R-4/6/7/8/10	ASI-346	980H-3	522-4748-001	ROCKWELL COLLINS	ANTENNA COUPLER TEST SET
180R-12	ASI-329-9	172H-17	777-1864-001	ROCKWELL COLLINS	ELECTRICAL DUMMY LOAD
180R-12	ASI-367-3	878L-19	522-4410-001	ROCKWELL COLLINS	DISCRIMINATOR MODULE TEST PANEL
180R-17	ASI-329-9	172H-17	777-1864-001	ROCKWELL COLLINS	ELECTRICAL DUMMY LOAD
180R-17	ASI-339	980H-6	777-1534-001	ROCKWELL COLLINS	ANTENNA COUPLER TEST SET
180R-17	ASI-339-1	878L-19A	772-5291-001	ROCKWELL COLLINS	DISCRIMINATOR PANEL
180R-17	ASI-339-2	878L-28	777-1856-001	ROCKWELL COLLINS	ELECTRONIC CONTROL AMPLIFIER TEST PANEL
180R-17	ASI-339-4	878L-30	777-1858-001	ROCKWELL COLLINS	COUPLER CIRCUIT CARD TEST PANEL
188M-1	ASI-40Y-29	440Y-29	787-6138-001	ROCKWELL COLLINS	980L-1 PLUG-IN ADAPTER
263BC101-2	ASI-604-1	263TS101-1	NPN	ACME AEROSPACE	BATTERY CHARGER TEST SET
263BC101-3	ASI-604-1	263TS101-1	NPN	ACME AEROSPACE	BATTERY CHARGER TEST SET
309A-1/1A	ASI-346	980H-3	522-4748-001	ROCKWELL COLLINS	ANTENNA COUPLER TEST SET
309A-2/2D/2E/2F	ASI-346	980H-3	522-4748-001	ROCKWELL COLLINS	ANTENNA COUPLER TEST SET
309A-3	ASI-346	980H-3	522-4748-001	ROCKWELL COLLINS	ANTENNA COUPLER TEST SET
309A-9/9A	ASI-367-1	878L-13	522-3981-001	ROCKWELL COLLINS	RELAY CONTROL MODULE TEST PANEL
309A-9/9A	ASI-367-2	878L-18	522-4409-001	ROCKWELL COLLINS	SERVO AMPLIFIER MODULE TEST PANEL
309A-17	ASI-339	980H-6	777-1534-001	ROCKWELL COLLINS	ANTENNA COUPLER TEST SET
309A-17	ASI-339-3	878L-29	777-1857-001	ROCKWELL COLLINS	COUPLER CONTROL TEST PANEL
309L-4	ASI-323-3	966D-5B	622-9034-001	ROCKWELL COLLINS	RADIO SET TEST PANEL
309M-1	ASI-323-3	966D-5B	622-9034-001	ROCKWELL COLLINS	RADIO SET TEST PANEL
323A-1	ASI-40Y-25	440Y-25	777-1044-001	ROCKWELL COLLINS	980L-1 PLUG-IN ADAPTER
323A-5	ASI-205	972S-2	622-1668-001	ROCKWELL COLLINS	AP-106/107 TEST PANEL
327C-3	ASI-205	972S-2	622-1668-001	ROCKWELL COLLINS	AP-106/107 TEST PANEL
327J-3	ASI-40Y-29	440Y-29	787-6138-001	ROCKWELL COLLINS	980L-1 PLUG-IN ADAPTER
328A-3G	ASI-180	NMN	NPN	ROCKWELL COLLINS	328A-3G SLAVING ACCESSORY TEST SET
329A-4/4V	ASI-205	972S-2	622-1668-001	ROCKWELL COLLINS	AP-106/107 TEST PANEL
328A-5	ASI-40Y-25	440Y-25	777-1044-001	ROCKWELL COLLINS	980L-1 PLUG-IN ADAPTER
329B-4	ASI-285	477P-1	522-1150-000	ROCKWELL COLLINS	APPROACH HORIZON TEST PANEL
329B-4A	ASI-285	477P-1	522-1150-000	ROCKWELL COLLINS	APPROACH HORIZON TEST PANEL
329B-4AX	ASI-285	477P-1	522-1150-000	ROCKWELL COLLINS	APPROACH HORIZON TEST PANEL
329B-4B	ASI-285	477P-1	522-1150-000	ROCKWELL COLLINS	APPROACH HORIZON TEST PANEL
329B-6D	ASI-191	978F-1D	522-3424-000	ROCKWELL COLLINS	INSTRUMENT TEST SET
329B-6D	ASI-167	978F-2S	522-3498-000	ROCKWELL COLLINS	SYNCHRO SIMULATOR
329B-6D	ASI-285	477P-1A	522-3329-000	ROCKWELL COLLINS	APPROACH HORIZON TEST PANEL
329B-6E	ASI-167	978F-2S	522-3498-000	ROCKWELL COLLINS	SYNCHRO SIMULATOR
329B-6E	ASI-191	978F-1D	522-3424-000	ROCKWELL COLLINS	INSTRUMENT TEST SET
329B-6E	ASI-285	477P-1A	522-3329-000	ROCKWELL COLLINS	APPROACH HORIZON TEST PANEL
329B-7/7()	ASI-167	978F-2S	522-3498-000	ROCKWELL COLLINS	SYNCHRO SIMULATOR
329B-7/7()	ASI-191	978F-1D	522-3424-000	ROCKWELL COLLINS	INSTRUMENT TEST SET
329B-7A	ASI-191	978F-1D	522-3424-000	ROCKWELL COLLINS	INSTRUMENT TEST SET
329B-7C	ASI-191	978F-1D	522-3424-000	ROCKWELL COLLINS	INSTRUMENT TEST SET
329B-7F	ASI-191	978F-1D	522-3424-000	ROCKWELL COLLINS	INSTRUMENT TEST SET
329B-7F-1	ASI-191	978F-1D	522-3424-000	ROCKWELL COLLINS	INSTRUMENT TEST SET
329B-7G	ASI-191	978F-1D	522-3424-000	ROCKWELL COLLINS	INSTRUMENT TEST SET
329B-7J	ASI-191	978F-1D	522-3424-000	ROCKWELL COLLINS	INSTRUMENT TEST SET
329B-7K	ASI-191	978F-1D	522-3424-000	ROCKWELL COLLINS	INSTRUMENT TEST SET
329B-7M	ASI-191	978F-1D	522-3424-000	ROCKWELL COLLINS	INSTRUMENT TEST SET
329B-7R()	ASI-167	978F-2S	522-3498-000	ROCKWELL COLLINS	SYNCHRO SIMULATOR
329B-8()	ASI-167	978F-2S	522-3498-000	ROCKWELL COLLINS	SYNCHRO SIMULATOR
329B-8A	ASI-191	978F-1D	522-3424-000	ROCKWELL COLLINS	INSTRUMENT TEST SET
329B-8B	ASI-191	978F-1D	522-3424-000	ROCKWELL COLLINS	INSTRUMENT TEST SET
329B-8C	ASI-191	978F-1D	522-3424-000	ROCKWELL COLLINS	INSTRUMENT TEST SET
329B-8F	ASI-167	978F-2S	522-3498-000	ROCKWELL COLLINS	SYNCHRO SIMULATOR

ASI TEST EQUIPMENT UNIT UNDER TEST (UUT) CROSS REFERENCE

UNIT TESTED	ASI MN	EQUIV MN	EQUIV PN	EQUIV OEM	DESCRIPTION
329B-8F	ASI-191	978F-1D	522-3424-000	ROCKWELL COLLINS	INSTRUMENT TEST SET
329B-8G	ASI-167	978F-2S	522-3498-000	ROCKWELL COLLINS	SYNCHRO SIMULATOR
329B-8G	ASI-40Y-36	440Y-36	787-6810-001	ROCKWELL COLLINS	980L-1 PLUG-IN ADAPTER
329B-8G	ASI-191	978F-1D	522-3424-000	ROCKWELL COLLINS	INSTRUMENT TEST SET
329B-8J	ASI-40Y-33	440Y-33	787-6142-001	ROCKWELL COLLINS	980L-1 PLUG-IN ADAPTER
329B-8J	ASI-230	NMN	229-0223-030	ROCKWELL COLLINS	FLUX KEEPER RING
329B-8L	ASI-40Y-43	440Y-43	787-6889-001	ROCKWELL COLLINS	980L-1 PLUG-IN ADAPTER
329B-8N	ASI-191	978F-1D	522-3424-000	ROCKWELL COLLINS	INSTRUMENT TEST SET
329B-8R	ASI-40Y-43	440Y-43	787-6889-001	ROCKWELL COLLINS	980L-1 PLUG-IN ADAPTER
329B-8R	ASI-167	978F-2S	522-3498-000	ROCKWELL COLLINS	SYNCHRO SIMULATOR
329B-8U	ASI-40Y-43	440Y-43	787-6889-001	ROCKWELL COLLINS	980L-1 PLUG-IN ADAPTER
329B-8U	ASI-167	978F-2S	522-3498-000	ROCKWELL COLLINS	SYNCHRO SIMULATOR
329B-8U-1	ASI-167	978F-2S	522-3498-000	ROCKWELL COLLINS	SYNCHRO SIMULATOR
329B-8U-1	ASI-40Y-43	440Y-43	792-6889-001	ROCKWELL COLLINS	980L-1 PLUG-IN ADAPTER
329B-8V	ASI-40Y-33	440Y-33	787-6142-001	ROCKWELL COLLINS	980L-1 PLUG-IN ADAPTER
329B-8V	ASI-167	978F-2S	522-3498-000	ROCKWELL COLLINS	SYNCHRO SIMULATOR
329B-8Y	ASI-40Y-33	440Y-33	787-6142-001	ROCKWELL COLLINS	980L-1 PLUG-IN ADAPTER
329B-8Y	ASI-167	978F-2S	522-3498-000	ROCKWELL COLLINS	SYNCHRO SIMULATOR
329B-8Z	ASI-40Y-43	440Y-43	787-6889-001	ROCKWELL COLLINS	980L-1 PLUG-IN ADAPTER
329B-8Z	ASI-167	978F-2S	522-3498-000	ROCKWELL COLLINS	SYNCHRO SIMULATOR
329B-9A	ASI-40Y-33	440Y-33	787-6142-001	ROCKWELL COLLINS	980L-1 PLUG-IN ADAPTER
329B-9L	ASI-40Y-43	440Y-43	792-6889-001	ROCKWELL COLLINS	980L-1 PLUG-IN ADAPTER
329T-1	ASI-205	972S-2	622-1668-001	ROCKWELL COLLINS	AUTOPILOT TEST SET
331A-3C	ASI-178	477Q-1	522-1151-000	ROCKWELL COLLINS	331A-3() INDICATOR TEST SET
331A-3C	ASI-166	479X-2	522-0167-001	ROCKWELL COLLINS	RESOLVER ZEROING PANEL
331A-3F	ASI-178	477Q-1	522-1151-000	ROCKWELL COLLINS	331A-3F/3G INDICATOR TEST SET
331A-3F	ASI-166	479X-2	522-0167-001	ROCKWELL COLLINS	RESOLVER ZEROING PANEL
331A-3G	ASI-166	479X-2	522-0167-001	ROCKWELL COLLINS	RESOLVER ZEROING PANEL
331A-3G	ASI-191	978F-1D	522-3424-000	ROCKWELL COLLINS	INSTRUMENT TEST SET
331A-3G	ASI-167	978F-2S	522-3498-000	ROCKWELL COLLINS	SYNCHRO SIMULATOR
331A-3G	ASI-178	477Q-1	522-1151-000	ROCKWELL COLLINS	INDICATOR TEST SET
331A-3G	ASI-178	477Q-1	522-1151-000	ROCKWELL COLLINS	331A-3F/3G INDICATOR TEST SET
331A-4()	ASI-178	477Q-1	522-1151-000	ROCKWELL COLLINS	INDICATOR TEST SET
331A-4()	ASI-166	479X-2	522-0167-001	ROCKWELL COLLINS	RESOLVER ZEROING PANEL
331A-6()/7()	ASI-166	479X-2	522-0167-001	ROCKWELL COLLINS	RESOLVER ZEROING PANEL
331A-6()/7()	ASI-178	477Q-1	522-1151-000	ROCKWELL COLLINS	INDICATOR TEST SET
331A-6()/7()	ASI-167	978F-2S	522-3498-000	ROCKWELL COLLINS	SYNCHRO SIMULATOR
331A-6()/7()	ASI-191	978F-1D	522-3424-000	ROCKWELL COLLINS	INSTRUMENT TEST SET
331A-6A	ASI-191	978F-1D	522-3424-000	ROCKWELL COLLINS	INSTRUMENT TEST SET
331A-6A	ASI-167	978F-2S	522-3498-000	ROCKWELL COLLINS	SYNCHRO SIMULATOR
331A-6A	ASI-166	479X-2	522-0167-001	ROCKWELL COLLINS	RESOLVER ZEROING PANEL
331A-6D	ASI-178	477Q-1A	522-3330-000	ROCKWELL COLLINS	COURSE INDICATOR TEST PANEL
331A-6D	ASI-191	978F-1D	522-3424-000	ROCKWELL COLLINS	INSTRUMENT TEST SET
331A-6E	ASI-191	978F-1D	522-3424-000	ROCKWELL COLLINS	INSTRUMENT TEST SET
331A-6K	ASI-191	978F-1D	522-3424-000	ROCKWELL COLLINS	INSTRUMENT TEST SET
331A-6K	ASI-167	978F-2S	522-3498-000	ROCKWELL COLLINS	SYNCHRO SIMULATOR
331A-6K	ASI-166	479X-2	522-0167-001	ROCKWELL COLLINS	RESOLVER ZEROING PANEL
331A-6P	ASI-167	978F-2S	522-3498-000	ROCKWELL COLLINS	SYNCHRO SIMULATOR
331A-6P/6R	ASI-167	978F-2S	522-3498-000	ROCKWELL COLLINS	SYNCHRO SIMULATOR
331A-6P/6R	ASI-191	978F-1D	522-3424-000	ROCKWELL COLLINS	INSTRUMENT TEST SET
331A-7	ASI-191	978F-1D	522-3424-000	ROCKWELL COLLINS	INSTRUMENT TEST SET
331A-7A	ASI-191	978F-1D	522-3424-000	ROCKWELL COLLINS	INSTRUMENT TEST SET
331A-8A/8K	ASI-40Y-23	440Y-23	777-1042-001	ROCKWELL COLLINS	980L-1 PLUG-IN ADAPTER
331A-8D	ASI-40Y-23	440Y-23	777-1042-001	ROCKWELL COLLINS	980L-1 PLUG-IN ADAPTER
331A-8G	ASI-40Y-19	440Y-19	777-1038-001	ROCKWELL COLLINS	980L-1 PLUG-IN ADAPTER
331A-8H	ASI-40Y-19	440Y-19	777-1038-001	ROCKWELL COLLINS	980L-1 PLUG-IN ADAPTER
331A-8L	ASI-40Y-23	440Y-23	777-1042-001	ROCKWELL COLLINS	980L-1 PLUG-IN ADAPTER
331A-9G	ASI-40Y-23	440Y-23	777-1042-001	ROCKWELL COLLINS	980L-1 PLUG-IN ADAPTER
331A-9G	ASI-167	978F-2S	522-3498-000	ROCKWELL COLLINS	SYNCHRO SIMULATOR
331A-9G	ASI-40Y-23AB	NMN	NPN	ROCKWELL COLLINS	331A-9G ADAPTER FOR 440Y-23
331D-7	ASI-358	969Y-1	622-5359-001	ROCKWELL COLLINS	HSI TEST PANEL
331P-1	ASI-205	972S-2	622-1668-001	ROCKWELL COLLINS	AP-106/107 TEST PANEL
332C-4	ASI-187	970E-1	622-2914-001	ROCKWELL COLLINS	RMI TEST PANEL
332C-8	ASI-187	970E-1	622-2914-001	ROCKWELL COLLINS	RMI TEST PANEL
332C-8	ASI-40Y-25	440Y-25	777-1044-001	ROCKWELL COLLINS	980L-1 PLUG-IN ADAPTER
332C-10/10B	ASI-187	970E-1	622-2914-001	ROCKWELL COLLINS	RMI TEST PANEL
332C-10/10B	ASI-167	978F-2S	522-3498-000	ROCKWELL COLLINS	SYNCHRO SIMULATOR
332D-11	ASI-168-1	NMN	NPN	ROCKWELL COLLINS	332D-11 NOISE TEST PANEL
332D-11	ASI-168	NMN	NPN	ROCKWELL COLLINS	332D-11() GYRO TEST SET
332D-11A	ASI-168-1	NMN	NPN	ROCKWELL COLLINS	332D-11 NOISE TEST PANEL
332D-11A	ASI-168	NMN	NPN	ROCKWELL COLLINS	332D-11() GYRO TEST SET
332D-11B	ASI-168-1	NMN	NPN	ROCKWELL COLLINS	332D-11 NOISE TEST PANEL
332D-11B	ASI-168	NMN	NPN	ROCKWELL COLLINS	332D-11() GYRO TEST SET
332D-11T	ASI-168-1	NMN	NPN	ROCKWELL COLLINS	332D-11 NOISE TEST PANEL
332D-11T	ASI-168	NMN	NPN	ROCKWELL COLLINS	332D-11() GYRO TEST SET

ASI TEST EQUIPMENT UNIT UNDER TEST (UUT) CROSS REFERENCE

UNIT TESTED	ASI MN	EQUIV MN	EQUIV PN	EQUIV OEM	DESCRIPTION
332D-11V	ASI-168-1	NMN	NPN	ROCKWELL COLLINS	332D-11 NOISE TEST PANEL
332D-11V	ASI-168	NMN	NPN	ROCKWELL COLLINS	332D-11() GYRO TEST SET
332D-12	ASI-205	972S-2	622-1668-001	ROCKWELL COLLINS	AP-106/107 TEST PANEL
332E-2	ASI-179	476E-7	NPN	ROCKWELL COLLINS	GYRO TEST SET
332E-4	ASI-179	476E-7	522-2078-000	ROCKWELL COLLINS	DIRECTIONAL GYRO TEST SET
332E-5	ASI-40Y-25	440Y-25	777-1044-001	ROCKWELL COLLINS	980L-1 PLUG-IN ADAPTER
332E-5	ASI-372	NMN	NPN	ROCKWELL COLLINS	332E-5 GYRO TEST PANEL
332G-2	ASI-40Y-3	440Y-3	522-4609-001	ROCKWELL COLLINS	980L-1 PLUG-IN ADAPTER
334C-11	ASI-206	972S-3	622-2562-001	ROCKWELL COLLINS	SERVO TEST SET
334C-1F	ASI-40Y-6	440Y-6	522-4900-001	ROCKWELL COLLINS	980L-1 PLUG-IN ADAPTER
334C-1G	ASI-40Y-6	440Y-6	522-4900-001	ROCKWELL COLLINS	980L-1 PLUG-IN ADAPTER
334C-3()	ASI-345	578F-1	522-1977-000	ROCKWELL COLLINS	MAGNETIC AMPLIFIER TEST PANEL
334C-6()	ASI-212-1	960M-1	622-0471-001	ROCKWELL COLLINS	TORQUE TESTER
334C-6()	ASI-213-1	NMN	608-3617-001	ROCKWELL COLLINS	SERVO LOOP TEST SET
334C-6()	ASI-213-2	NMN	608-0789-001	ROCKWELL COLLINS	MINIMUM PERFORMANCE TEST SET
334C-9/9A/11	ASI-206	972S-3	622-2562-001	ROCKWELL COLLINS	SERVO TEST SET
334C-9/9A	ASI-212-2	960M-2	622-2094-001	ROCKWELL COLLINS	TORQUE TESTER
334C-9/9A/11/12H	ASI-212-3	960M-3	622-2741-001	ROCKWELL COLLINS	SERVO TORQUE TESTER
334C-9/9A/11	ASI-206	972S-3	622-2562-001	ROCKWELL COLLINS	SERVO TEST SET
334C-9/9A/11	ASI-246-1	NMN	621-9185-001	ROCKWELL COLLINS	CAPSTAN TEST FIXTURE
334C-12	ASI-431	972S-4	622-3211-001	ROCKWELL COLLINS	SERVO TEST PANEL
334D-6()	ASI-212-3	960M-3	622-2741-001	ROCKWELL COLLINS	SERVO TORQUE TESTER
334D-6()	ASI-206	972S-3	622-2562-001	ROCKWELL COLLINS	SERVO TEST SET
334D-6()	ASI-212-2	960M-2	622-2094-001	ROCKWELL COLLINS	TORQUE TESTER
339F-12	ASI-416	NMN	NPN	ROCKWELL COLLINS	DME TEST SET
339H-1	ASI-164	NMN	NPN	ROCKWELL COLLINS	RADIO ALTIMETER INDICATOR TEST PANEL
339H-1/1A/1B	ASI-231-1	974G-1	NPN	ROCKWELL COLLINS	INDICATOR TEST SET
339H-1/1A/1B	ASI-231R	NMN	NPN	ROCKWELL COLLINS	SPECIAL TEST PANEL
339H-1/1A/1B	ASI-232	NMN	229-9515-050	ROCKWELL COLLINS	MAGNET KEEPER
339H-1A	ASI-164	NMN	NPN	ROCKWELL COLLINS	RADIO ALTIMETER INDICATOR TEST PANEL
339H-1B	ASI-164	NMN	NPN	ROCKWELL COLLINS	RADIO ALTIMETER INDICATOR TEST PANEL
339H-1C	ASI-164	NMN	NPN	ROCKWELL COLLINS	RADIO ALTIMETER INDICATOR TEST PANEL
339H-1D	ASI-164	NMN	NPN	ROCKWELL COLLINS	RADIO ALTIMETER INDICATOR TEST PANEL
339H-2	ASI-164	NMN	NPN	ROCKWELL COLLINS	RADIO ALTIMETER INDICATOR TEST PANEL
339H-4/4A	ASI-200-20	NMN	NPN	ROCKWELL COLLINS	RADIO ALTIMETER TEST PANEL
339H-5	ASI-164	NMN	NPN	ROCKWELL COLLINS	RADIO ALTIMETER INDICATOR TEST PANEL
339H-6	ASI-164	NMN	NPN	ROCKWELL COLLINS	RADIO ALTIMETER INDICATOR TEST PANEL
339H-6	ASI-258-1	NMN	NPN	ROCKWELL COLLINS	339H-6 (-001) TEST PANEL
339H-6	ASI-258-2	NMN	NPN	ROCKWELL COLLINS	339H-6 TEST PANEL
339H-6	ASI-259-R	NMN	NPN	ROCKWELL COLLINS	TAPE WINDING FIXTURE - LEFT
339H-6	ASI-259-L	NMN	NPN	ROCKWELL COLLINS	TAPE WINDING FIXTURE - RIGHT
339H-6	ASI-25-9A	NMN	647-6485-005	ROCKWELL COLLINS	SERVO ASSY PIN NO. 3
339H-6	ASI-25-9B	NMN	647-6485-004	ROCKWELL COLLINS	SERVO ASSY PIN NO. 4
344B-1	ASI-166	479X-2	522-0167-001	ROCKWELL COLLINS	RESOLVER ZEROING PANEL
344C-1D	ASI-40Y-8	440Y-8	522-4957-001	ROCKWELL COLLINS	980L-1 PLUG-IN ADAPTER
344C-1E/1K	ASI-40Y-14	440Y-14	522-4963-001	ROCKWELL COLLINS	980L-1 PLUG-IN ADAPTER
344C-1()	ASI-377-1	978F-4A	522-3427-000	ROCKWELL COLLINS	AMPLIFIER TEST PANEL
345A-4()	ASI-40Y-3	440Y-3	522-4609-001	ROCKWELL COLLINS	980L-1 PLUG-IN ADAPTER
345C-2A	ASI-40Y-11	440Y-11	522-4960-001	ROCKWELL COLLINS	980L-1 PLUG-IN ADAPTER
346B-3	ASI-325	NMN	NPN	ROCKWELL COLLINS	TEST FIXTURE
346D-1A/1B	ASI-222-1	NMN	NMN	ROCKWELL COLLINS	TEST FIXTURE (INCL LOADS AND SPKR PANEL)
346D-2/2B	ASI-222-1	NMN	NMN	ROCKWELL COLLINS	TEST FIXTURE (INCL LOADS AND SPKR PANEL)
374D-3	ASI-226	514M-2	622-7082-001	ROCKWELL COLLINS	INTERFACE PANEL
377J-3	ASI-226	514M-2	622-7082-001	ROCKWELL COLLINS	INTERFACE PANEL
379F-1()	ASI-300	973W-2	622-5058-001	ROCKWELL COLLINS	RADIO TEST SET
379F-1()	ASI-301	973W-3	622-6121-001	ROCKWELL COLLINS	RADIO TEST SET
437R-1	ASI-340-1	980H-2	522-4541-001	ROCKWELL COLLINS	ANTENNA TESTER / SIMULATOR
454N-2/2D	ASI-205	972S-2	622-1668-001	ROCKWELL COLLINS	AP-106/107 TEST PANEL
454N-2/2D	ASI-205-3	NMN	NPN	ROCKWELL COLLINS	RATE LEVEL SENSOR TEST SET
454N-3	ASI-205-2	NMN	NPN	ROCKWELL COLLINS	TRIM SERVO TEST SET
479S-6()	ASI-223	478A-3	622-3701-001	ROCKWELL COLLINS	ZIFOR III VOR RADIAL STANDARD
479V-3	ASI-166A	NMN	NPN	ROCKWELL COLLINS	479V-3 TEST FIXTURE
490A-1	ASI-323-3	966D-5B	622-9034-001	ROCKWELL COLLINS	RADIO SET TEST PANEL
490A-1	ASI-329-4	DA-174/GRM-10	522-1248-004	ROCKWELL COLLINS	ELECTRICAL DUMMY LOAD
490A-1	ASI-329-6	DA-173/GRM-10	522-1247-002	ROCKWELL COLLINS	ELECTRICAL DUMMY LOAD
490A-2	ASI-323-3	966D-5B	622-9034-001	ROCKWELL COLLINS	RADIO SET TEST PANEL
490A-2	ASI-329-5	DA-175/GRM-10	522-1249-004	ROCKWELL COLLINS	ELECTRICAL DUMMY LOAD
490A-5	ASI-323-3	966D-5B	622-9034-001	ROCKWELL COLLINS	RADIO SET TEST PANEL
490R-6	ASI-329-12	172H-12	777-1455-001	ROCKWELL COLLINS	DUMMY ANTENNA
490S-1	ASI-207	477W-7	622-0158-001	ROCKWELL COLLINS	TEST BENCH HARNESS
490S-1	ASI-207-1	172H-18	622-0180-001	ROCKWELL COLLINS	DUMMY ANTENNA SHUNT
490S-1	ASI-207-2	678P-5	622-0304-001	ROCKWELL COLLINS	RADIO SET TEST HARNESS
490S-1	ASI-208	980H-5	777-1526-001	ROCKWELL COLLINS	ANTENNA COUPLER TEST SET
490S-1	ASI-208-1	878L-19D	622-0226-001	ROCKWELL COLLINS	DISCRIMINATOR TEST SET
490S-1	ASI-208-3	878L-39	622-0227-001	ROCKWELL COLLINS	SERVO-POWER SUPPLY TEST PANEL

ASI TEST EQUIPMENT UNIT UNDER TEST (UUT) CROSS REFERENCE

UNIT TESTED	ASI MN	EQUIV MN	EQUIV PN	EQUIV OEM	DESCRIPTION
490S-1	ASI-208-4	878L-40	622-0228-001	ROCKWELL COLLINS	TUNER-CHASSIS TEST PANEL
490S-1	ASI-208-5	878L-41	622-0229-001	ROCKWELL COLLINS	LOGIC CARD TEST SET
490S-1	ASI-329-3	172H-18A	622-7148-001	ROCKWELL COLLINS	SHUNT DUMMY ANTENNA
490S-1	ASI-700-4	NMN	NPN	ROCKWELL COLLINS	HF/VHF DISCRETE FUNCTION INTERFACE UNIT
490S-4	ASI-207-1	172H-18	622-0180-001	ROCKWELL COLLINS	DUMMY ANTENNA SHUNT
490S-4	ASI-323-3	966D-5B	622-9034-001	ROCKWELL COLLINS	RADIO SET TEST PANEL
490S-4	ASI-329-3	172H-18A	622-7148-001	ROCKWELL COLLINS	SHUNT DUMMY ANTENNA
490T-1/1A	ASI-340-1	980H-2	522-4541-001	ROCKWELL COLLINS	ANTENNA TESTER / SIMULATOR
490T-1/1A/2/2A/4/9	ASI-328	980H-1	522-4380-001	ROCKWELL COLLINS	ANTENNA COUPLER TEST SET
490T-1/1A/2/2A/9	ASI-329-1	172H-8	522-4514-001	ROCKWELL COLLINS	ELECTRICAL DUMMY LOAD
490T-1/1A/2/2A/9	ASI-329-1A	172H-8	522-4514-002	ROCKWELL COLLINS	ELECTRICAL DUMMY LOAD
490T-1/1A/2/2A/9	ASI-329-1B	DA-487/U	522-4514-001	ROCKWELL COLLINS	ELECTRICAL DUMMY LOAD
490T-3	ASI-329-7	172H-21	622-1380-001	ROCKWELL COLLINS	ANTENNA SIMULATOR
490T-4	ASI-328	980H-1	522-4380-001	ROCKWELL COLLINS	ANTENNA COUPLER TEST SET
490T-9	ASI-328	980H-1	522-4380-001	ROCKWELL COLLINS	ANTENNA COUPLER TEST SET
5082-1	ASI-349-1	2482-1	NPN	ROCKWELL COLLINS	PAA TEST PANEL
5088-1	ASI-349-1	2488-1	NPN	ROCKWELL COLLINS	ICU TEST PANEL
5289-1	ASI-349-1	TR5289-1	NPN	ROCKWELL COLLINS	ACU TEST PANEL
5260-1	ASI-349-4	TR5260-1	NPN	ROCKWELL COLLINS	AREU TEST PANEL
5260-60	ASI-349-3	TR5260-40-9	NPN	ROCKWELL COLLINS	STATION CARD TEST PANEL
5261-1	ASI-349-3	2361-1	NPN	ROCKWELL COLLINS	ACP TEST PANEL
5264-1	ASI-349-2	TR5289-1	NPN	ROCKWELL COLLINS	EU TEST PANEL
51R-10/10A/10B	ASI-161	479V-3	NPN	ROCKWELL COLLINS	PRECISION TRACK SELECTOR
51R-10/10A/10B	ASI-221-1	968Y-1	622-4768-001	ROCKWELL COLLINS	ARINC 547 VOR/ILS TEST SET
51R-10/10A/10B	ASI-280	NMN	NPN	ROCKWELL COLLINS	CPU TEST SET
51R-11/11A/11B	ASI-221-1	968Y-1	622-4768-001	ROCKWELL COLLINS	ARINC 547 VOR/ILS TEST SET
51R-6	ASI-161	479V-3	NPN	ROCKWELL COLLINS	PRECISION TRACK SELECTOR
51R-7/7A	ASI-161	479V-3	NPN	ROCKWELL COLLINS	PRECISION TRACK SELECTOR
51R-8/8A	ASI-161	479V-3	NPN	ROCKWELL COLLINS	PRECISION TRACK SELECTOR
51RV-1	ASI-161	479V-3	NPN	ROCKWELL COLLINS	PRECISION TRACK SELECTOR
51RV-1A	ASI-161	479V-3	NPN	ROCKWELL COLLINS	PRECISION TRACK SELECTOR
51RV-1A	ASI-221-1	968Y-1	622-4768-001	ROCKWELL COLLINS	ARINC 547 VOR/ILS TEST SET
51RV-1C	ASI-161	479V-3	NPN	ROCKWELL COLLINS	PRECISION TRACK SELECTOR
51RV-1C	ASI-221-1	968Y-1	622-4768-001	ROCKWELL COLLINS	ARINC 547 VOR/ILS TEST SET
51RV-2B	ASI-161	479V-3	NPN	ROCKWELL COLLINS	PRECISION TRACK SELECTOR
51RV-2/2B	ASI-221-1	968Y-1	622-4768-001	ROCKWELL COLLINS	ARINC 547 VOR/ILS TEST SET
51RV-2B	ASI-327-1	977A-1	777-1356-001	ROCKWELL COLLINS	51RV-2B TEST PANEL
51RV-4/4()	ASI-221-1	968Y-1	622-4768-001	ROCKWELL COLLINS	ARINC 547 VOR/ILS TEST SET
51RV-4/4()	ASI-161	479V-3	NPN	ROCKWELL COLLINS	PRECISION TRACK SELECTOR
51RV-4/4()	ASI-280	NMN	NPN	ROCKWELL COLLINS	CPU TEST SET
51RV-5/5B/5D	ASI-221-1	968Y-1	622-4768-001	ROCKWELL COLLINS	ARINC 547 VOR/ILS TEST SET
51Y-3	ASI-192	477U-2	522-2710-000	ROCKWELL COLLINS	ADF ANTENNA SIMULATOR
5141-1-()	ASI-349-5AV	NMN	2020-1-AV	AVTECH	CONTROL PANEL TEST SET
5144-1-()	ASI-349-5AV	NMN	2020-1-AV	AVTECH	CONTROL PANEL TEST SET
5145-1-()	ASI-349-5AV	NMN	2020-1-AV	AVTECH	CONTROL PANEL TEST SET
5145-1-()	ASI-349-50	NMN	2020-1-1	AVTECH	SELCAL TESTER
5145-1-()	ASI-349-51	NMN	2020-1-2	AVTECH	SELCAL TESTER
514A-12	ASI-323-3	966D-5B	622-9034-001	ROCKWELL COLLINS	RADIO SET TEST PANEL
514A-13	ASI-323-3	966D-5B	622-9034-001	ROCKWELL COLLINS	RADIO SET TEST PANEL
514A-8	ASI-323-3	966D-5B	622-9034-001	ROCKWELL COLLINS	RADIO SET TEST PANEL
514A-9	ASI-323-3	966D-5B	622-9034-001	ROCKWELL COLLINS	RADIO SET TEST PANEL
51Y-4/4A	ASI-192	477U-2	522-2710-000	ROCKWELL COLLINS	ADF ANTENNA SIMULATOR
51Y-4/4A	ASI-193	477V-2	522-2711-002	ROCKWELL COLLINS	ADF TEST SET
51Y-4/4A	ASI-201-2	477U-3	522-4458-002	ROCKWELL COLLINS	ADF TEST SET
51Y-7()	ASI-184	477V-3	792-6209-001	ROCKWELL COLLINS	FAULT ISOLATION PANEL
51Y-7()	ASI-192	477U-2	522-2710-000	ROCKWELL COLLINS	ADF ANTENNA SIMULATOR
51Y-7()	ASI-193	477V-2	522-2711-002	ROCKWELL COLLINS	ADF TEST SET
51Y-7()	ASI-233	NMN	NPN	ROCKWELL COLLINS	RF BAL ADJ TEST FIXTURE
51Y-7()	ASI-234	NMN	NPN	ROCKWELL COLLINS	50 OHM PROBE
51Y-7()	ASI-235	NMN	NPN	ROCKWELL COLLINS	SPECIAL SOLDER TIP
51Z-3	ASI-236	NMN	NPN	ROCKWELL COLLINS	TEST FIXTURE
51Z-4	ASI-236	NMN	NPN	ROCKWELL COLLINS	TEST FIXTURE
51Z-4	ASI-236	NMN	NPN	ROCKWELL COLLINS	TEST AND ALIGN JIG
51Z-6	ASI-236	NMN	NPN	ROCKWELL COLLINS	TEST FIXTURE
5260-1	ASI-349-4	TR5260-1	NPN	AVTECH	TEST PANEL
5261-1	ASI-349-3	2361-1	NPN	AVTECH	TEST PANEL
5264-1	ASI-349-2	TR5264-1	NPN	AVTECH	TEST PANEL
5289-1	ASI-349-1	TR5289-1	NPN	AVTECH	TEST PANEL
548S-3/3A/5/5A/6	ASI-207-1	172H-18	622-0180-001	ROCKWELL COLLINS	DUMMY LOAD
548S-3/3A/5/5A/6	ASI-328-3	878L-17	522-4254-001	ROCKWELL COLLINS	DISCRIMINATOR TEST PANEL
548S-3/3A/5/5A/6	ASI-329-11	172H-22	622-1381-001	ROCKWELL COLLINS	SHUNT DUMMY ANTENNA
548S-3/3A/5/5A/6	ASI-329-7	172H-21	622-1380-001	ROCKWELL COLLINS	ANTENNA SIMULATOR
548S-3/3A/5/5A/6	ASI-497-1	967M-1	622-5285-001	ROCKWELL COLLINS	HARMONIC FILTER
548S-3/3A/5/5A/6	ASI-497-2	967M-2	622-5286-001	ROCKWELL COLLINS	DUAL SERVO AMPLIFIER TEST SET
548S-3/3A/5/5A/6	ASI-497-3	967M-3	622-5287-001	ROCKWELL COLLINS	POWER AMPLIFIER TEST SET

ASI TEST EQUIPMENT UNIT UNDER TEST (UUT) CROSS REFERENCE

UNIT TESTED	ASI MN	EQUIV MN	EQUIV PN	EQUIV OEM	DESCRIPTION
548S-3/3A/5/5A/6	ASI-497-4	967M-4	622-5288-001	ROCKWELL COLLINS	CONTROL CIRCUIT CARD TEST SET
548S-3/3A/5/5A/6	ASI-497-5	967M-5	622-5289-001	ROCKWELL COLLINS	PREREGULATOR TEST SET
54W-1E	ASI-40Y-12	440Y-12	522-4961-001	ROCKWELL COLLINS	980L-1 PLUG-IN ADAPTER
54W-1F	ASI-40Y-12	440Y-12	522-4961-001	ROCKWELL COLLINS	980L-1 PLUG-IN ADAPTER
54W-3	ASI-40Y-24	440Y-24	777-1043-001	ROCKWELL COLLINS	980L-1 PLUG-IN ADAPTER
54W-3A	ASI-40Y-24	440Y-24	777-1043-001	ROCKWELL COLLINS	980L-1 PLUG-IN ADAPTER
54W-3B	ASI-40Y-24	440Y-24	777-1043-001	ROCKWELL COLLINS	980L-1 PLUG-IN ADAPTER
54W-4	ASI-40Y-34	440Y-34	787-6143-001	ROCKWELL COLLINS	980L-1 PLUG-IN ADAPTER
562A-5()	ASI-276	477N-1	522-1149-000	ROCKWELL COLLINS	STEERING COMPUTER TEST PANEL
562A-5()	ASI-377-2	978F-9A	522-4085-000	ROCKWELL COLLINS	AMPLIFIER TEST ADAPTER
562A-5()	ASI-377-3	978F-5R	522-3501-000	ROCKWELL COLLINS	ROLL STEERING COMPUTER TEST PANEL
562A-5()	ASI-377-4	978F-10R	522-4086-001	ROCKWELL COLLINS	ROLL STEERING COMPUTER TEST ADAPTER
562A-5()	ASI-377-5	978F-6P	522-3426-000	ROCKWELL COLLINS	PITCH STEERING COMPUTER TEST PANEL
562A-5E	ASI-276A	477N-1A	522-3328-000	ROCKWELL COLLINS	STEERING COMPUTER TEST PANEL
562A-5F	ASI-40Y-5	440Y-5	522-4899-001	ROCKWELL COLLINS	980L-1 PLUG-IN ADAPTER
562A-5F	ASI-40Y-5	440Y-5	522-4899-001	ROCKWELL COLLINS	980L-1 PLUG-IN ADAPTER
562A-5F1	ASI-40Y-5	440Y-5	522-4899-001	ROCKWELL COLLINS	980L-1 PLUG-IN ADAPTER
562A-5F2	ASI-40Y-5	440Y-5	522-4899-001	ROCKWELL COLLINS	980L-1 PLUG-IN ADAPTER
562A-5F4	ASI-40Y-5	440Y-5	522-4899-001	ROCKWELL COLLINS	980L-1 PLUG-IN ADAPTER
562A-5F5	ASI-40Y-5	440Y-5	522-4899-001	ROCKWELL COLLINS	980L-1 PLUG-IN ADAPTER
562A-5M	ASI-40Y-15	440Y-15	522-4964-001	ROCKWELL COLLINS	980L-1 PLUG-IN ADAPTER
562A-5M5	ASI-286-1	CTS-82	622-4562-001	ROCKWELL COLLINS	AUTOPILOT TEST SET
562A-5M5	ASI-40Y-15	440Y-15	522-4964-001	ROCKWELL COLLINS	980L-1 PLUG-IN ADAPTER
562C-13/13A	ASI-204	972S-1	622-1626-001	ROCKWELL COLLINS	AUTOPILOT RAMP TEST SET
562C-13/13A	ASI-205	972S-2	622-1668-001	ROCKWELL COLLINS	AP-106/107 TEST PANEL
562C-3E	ASI-40Y-27	440Y-27	787-6073-001	ROCKWELL COLLINS	980L-1 PLUG-IN ADAPTER
562C-4	ASI-40Y-1	440Y-1	522-4606-001	ROCKWELL COLLINS	980L-1 PLUG-IN ADAPTER
562C-4A	ASI-40Y-16	440Y-16	777-1035-001	ROCKWELL COLLINS	980L-1 PLUG-IN ADAPTER
562C-4E	ASI-40Y-1	440Y-1	522-4606-001	ROCKWELL COLLINS	980L-1 PLUG-IN ADAPTER
562C-5	ASI-286-1	CTS-82	622-4562-001	ROCKWELL COLLINS	AUTOPILOT TEST SET
562C-5	ASI-40Y-38	440Y-38	792-6383-001	ROCKWELL COLLINS	980L-1 PLUG-IN ADAPTER
562C-5()	ASI-167	978F-2S	522-3498-000	ROCKWELL COLLINS	SYNCHRO SIMULATOR
562C-5()	ASI-183-1	971F-1	622-2013-002	ROCKWELL COLLINS	FCS-105 AUTOPILOT TEST SET
562C-5G	ASI-40Y-2	440Y-2	522-4607-001	ROCKWELL COLLINS	980L-1 PLUG-IN ADAPTER
562C-8A	ASI-183-1	971F-1	622-2013-002	ROCKWELL COLLINS	FCS-105 AUTOPILOT TEST SET
562C-8A	ASI-247	NMN	634-0549-001	ROCKWELL COLLINS	YAW DAMPER TEST FIXTURE
562C-8A	ASI-40Y-38	440Y-38	792-6383-001	ROCKWELL COLLINS	980L-1 PLUG-IN ADAPTER
562C-8B	ASI-40Y-38	440Y-38	792-6383-001	ROCKWELL COLLINS	980L-1 PLUG-IN ADAPTER
562C-8F/8G	ASI-183-1	971F-1	622-2013-002	ROCKWELL COLLINS	FCS-105 AUTOPILOT TEST SET
562C-8F/8G	ASI-247	NMN	634-0549-001	ROCKWELL COLLINS	YAW DAMPER TEST FIXTURE
562P-1	ASI-40Y-9	440Y-9	522-4958-001	ROCKWELL COLLINS	980L-1 PLUG-IN ADAPTER
562P-1()	ASI-377-1	978F-4A	522-3427-000	ROCKWELL COLLINS	AMPLIFIER TEST PANEL
562P-1()	ASI-377-2	978F-9A	522-4085-000	ROCKWELL COLLINS	AMPLIFIER TEST ADAPTER
562P-1()	ASI-377-5	978F-6P	522-3426-000	ROCKWELL COLLINS	PITCH STEERING COMPUTER TEST PANEL
562P-1()	ASI-377-6	978F-11P	522-4113-000	ROCKWELL COLLINS	PITCH STEERING COMPUTER TEST ADAPTER
562P-1E/1E1	ASI-167	978F-2S	522-3498-000	ROCKWELL COLLINS	SYNCHRO SIMULATOR
562R-1	ASI-40Y-9	440Y-9	522-4958-001	ROCKWELL COLLINS	980L-1 PLUG-IN ADAPTER
562R-1()	ASI-377-1	978F-4A	522-3427-000	ROCKWELL COLLINS	AMPLIFIER TEST PANEL
562R-1()	ASI-377-2	978F-9A	522-4085-000	ROCKWELL COLLINS	AMPLIFIER TEST ADAPTER
562R-1()	ASI-377-3	978F-5R	522-3501-000	ROCKWELL COLLINS	ROLL STEERING COMPUTER TEST PANEL
562R-1()	ASI-377-4	978F-10R	522-4086-001	ROCKWELL COLLINS	ROLL STEERING COMPUTER TEST ADAPTER
562R-1E	ASI-167	978F-2S	522-3498-000	ROCKWELL COLLINS	SYNCHRO SIMULATOR
562R-1E	ASI-167	978F-2S	522-3498-000	ROCKWELL COLLINS	SYNCHRO SIMULATOR
562R-1E	ASI-40Y-9	440Y-9	522-4958-001	ROCKWELL COLLINS	980L-1 PLUG-IN ADAPTER
562R-1F	ASI-167	978F-2S	522-3498-000	ROCKWELL COLLINS	SYNCHRO SIMULATOR
562R-1F	ASI-40Y-9	440Y-9	522-4958-001	ROCKWELL COLLINS	980L-1 PLUG-IN ADAPTER
590A-3	ASI-CTS-10	CTS-10	622-4561-00	ROCKWELL COLLINS	UNIVERSAL ATR BREAKOUT BOX
590A-3()	ASI-40Y-3	440Y-3	522-4609-001	ROCKWELL COLLINS	980L-1 PLUG-IN ADAPTER
590A-3H	ASI-151	NMN	NPN	ROCKWELL COLLINS	AIR DATA CONTROL TEST SET
590A-3J	ASI-151	NMN	NPN	ROCKWELL COLLINS	AIR DATA CONTROL TEST SET
590A-3J1	ASI-151	NMN	NPN	ROCKWELL COLLINS	AIR DATA CONTROL TEST SET
590A-3K	ASI-151	NMN	NPN	ROCKWELL COLLINS	AIR DATA CONTROL TEST SET
590A-3K1	ASI-151	NMN	NPN	ROCKWELL COLLINS	AIR DATA CONTROL TEST SET
590A-5	ASI-40Y-17	440Y-17	777-1036-001	ROCKWELL COLLINS	980L-1 PLUG-IN ADAPTER
590A-6	ASI-205	972S-2	622-1668-001	ROCKWELL COLLINS	AP-106/107 TEST PANEL
590B-2	ASI-250	NMN	685-6220-001	ROCKWELL COLLINS	TEST AID AND BREAKOUT BOX
590B-2	ASI-40Y-3	440Y-3	522-4609-001	ROCKWELL COLLINS	980L-1 PLUG-IN ADAPTER
590B-3	ASI-205	972S-2	622-1668-001	ROCKWELL COLLINS	AP-106/107 TEST PANEL
614E-10()	ASI-167	978F-2S	522-3498-000	ROCKWELL COLLINS	SYNCHRO SIMULATOR
614E-10()	ASI-229	NMN	NPN	ROCKWELL COLLINS	MODE SEL SWITCH ADJUST FIXTURE
614E-10()	ASI-377-7	978F-3M	522-3423-00	ROCKWELL COLLINS	MODE CONTROL TEST PANEL
614E-10()	ASI-40Y-13	440Y-13	522-4962-001	ROCKWELL COLLINS	980L-1 PLUG-IN ADAPTER
614E-10H	ASI-167	978F-2S	522-3498-000	ROCKWELL COLLINS	SYNCHRO SIMULATOR
614E-11/11A	ASI-167	978F-2S	522-3498-000	ROCKWELL COLLINS	SYNCHRO SIMULATOR
614E-11/11A	ASI-40Y-13	440Y-13	522-4962-001	ROCKWELL COLLINS	980L-1 PLUG-IN ADAPTER

ASI TEST EQUIPMENT UNIT UNDER TEST (UUT) CROSS REFERENCE

UNIT TESTED	ASI MN	EQUIV MN	EQUIV PN	EQUIV OEM	DESCRIPTION
614E-13()	ASI-167	978F-2S	522-3498-000	ROCKWELL COLLINS	SYNCHRO SIMULATOR
614E-13()	ASI-40Y-13	440Y-13	522-4962-001	ROCKWELL COLLINS	980L-1 PLUG-IN ADAPTER
614E-20()	ASI-40Y-20	440Y-20	777-1039-001	ROCKWELL COLLINS	980L-1 PLUG-IN ADAPTER
614E-20G	ASI-40Y-39	440Y-39	792-6384-001	ROCKWELL COLLINS	980L-1 PLUG-IN ADAPTER
614E-20H	ASI-40Y-39	440Y-39	792-6384-001	ROCKWELL COLLINS	980L-1 PLUG-IN ADAPTER
614E-20I	ASI-40Y-39	440Y-39	792-6384-001	ROCKWELL COLLINS	980L-1 PLUG-IN ADAPTER
614E-22	ASI-40Y-19	440Y-19	777-1038-001	ROCKWELL COLLINS	980L-1 PLUG-IN ADAPTER
614E-22B	ASI-40Y-19	440Y-19	777-1038-001	ROCKWELL COLLINS	980L-1 PLUG-IN ADAPTER
614E-22G/22L	ASI-166	479X-2	522-0167-001	ROCKWELL COLLINS	RESOLVER ZEROING PANELL
614E-22G/22L	ASI-167	978F-2S	522-3498-000	ROCKWELL COLLINS	SYNCHRO SIMULATOR
614E-23()	ASI-40Y-20	440Y-20	777-1039-001	ROCKWELL COLLINS	980L-1 PLUG-IN ADAPTER
614E-23E	ASI-40Y-39	440Y-39	792-6384-001	ROCKWELL COLLINS	980L-1 PLUG-IN ADAPTER
614E-23G	ASI-40Y-39	440Y-39	792-6384-001	ROCKWELL COLLINS	980L-1 PLUG-IN ADAPTER
614E-27	ASI-40Y-31	440Y-31	787-6140-001	ROCKWELL COLLINS	980L-1 PLUG-IN ADAPTER
614E-2F	ASI-40Y-3	440Y-3	522-4609-001	ROCKWELL COLLINS	980L-1 PLUG-IN ADAPTER
614E-2G	ASI-40Y-3	440Y-3	522-4609-001	ROCKWELL COLLINS	980L-1 PLUG-IN ADAPTER
614E-2G1	ASI-40Y-3	440Y-3	522-4609-001	ROCKWELL COLLINS	980L-1 PLUG-IN ADAPTER
614E-36	ASI-40Y-31	440Y-31	787-6140-001	ROCKWELL COLLINS	980L-1 PLUG-IN ADAPTER
614E-4	ASI-40Y-17	440Y-17	777-1036-001	ROCKWELL COLLINS	980L-1 PLUG-IN ADAPTER
614E-41/41A	ASI-205	972S-2	622-1668-001	ROCKWELL COLLINS	AP-106/107 TEST PANEL
614E-4B	ASI-40Y-17	440Y-17	777-1036-001	ROCKWELL COLLINS	980L-1 PLUG-IN ADAPTER
614E-4C	ASI-40Y-31	440Y-31	787-6140-001	ROCKWELL COLLINS	980L-1 PLUG-IN ADAPTER
614E-5A	ASI-183-1	971F-1	622-2013-002	ROCKWELL COLLINS	FCS-105 AUTOPILOT TEST SET
614E-5A	ASI-40Y-38	440Y-38	792-6383-001	ROCKWELL COLLINS	980L-1 PLUG-IN ADAPTER
614E-5C	ASI-40Y-38	440Y-38	792-6383-001	ROCKWELL COLLINS	980L-1 PLUG-IN ADAPTER
614E-7()	ASI-167	978F-2S	522-3498-000	ROCKWELL COLLINS	SYNCHRO SIMULATOR
614E-7()	ASI-377-7	978F-3M	522-3423-00	ROCKWELL COLLINS	MODE CONTROL TEST PANEL
614E-7()	ASI-40Y-13	440Y-13	522-4962-001	ROCKWELL COLLINS	980L-1 PLUG-IN ADAPTER
614E-8()	ASI-377-7	978F-3M	522-3423-00	ROCKWELL COLLINS	MODE CONTROL TEST PANEL
614E-8A	ASI-40Y-13	440Y-13	522-4962-001	ROCKWELL COLLINS	980L-1 PLUG-IN ADAPTER
614E-8B	ASI-40Y-13	440Y-13	522-4962-001	ROCKWELL COLLINS	980L-1 PLUG-IN ADAPTER
614E-9()	ASI-377-7	978F-3M	522-3423-00	ROCKWELL COLLINS	MODE CONTROL TEST PANEL
614E-9B	ASI-40Y-13	440Y-13	522-4962-001	ROCKWELL COLLINS	980L-1 PLUG-IN ADAPTER
614E-9C/9E	ASI-167	978F-2S	522-3498-000	ROCKWELL COLLINS	SYNCHRO SIMULATOR
614E-9C/9E	ASI-40Y-13	440Y-13	522-4962-001	ROCKWELL COLLINS	980L-1 PLUG-IN ADAPTER
614E-9G	ASI-40Y-13	440Y-13	522-4962-001	ROCKWELL COLLINS	980L-1 PLUG-IN ADAPTER
614L-12()	ASI-243	NMN	NPN	ROCKWELL COLLINS	BREAKOUT BOX
614L-8	ASI-201-2	477U-3	522-4458-002	ROCKWELL COLLINS	ADF TEST SET
618M-1	ASI-221-2	NMN	NPN	ROCKWELL COLLINS	COMMUNICATIONS R/T TEST PANEL
618M-2B/2D	ASI-221-2	NMN	NPN	ROCKWELL COLLINS	COMMUNICATIONS R/T TEST PANEL
618M-3/3A	ASI-221-2	NMN	NPN	ROCKWELL COLLINS	COMMUNICATIONS R/T TEST PANEL
618M-4/4A	ASI-221-2	NMN	NPN	ROCKWELL COLLINS	COMMUNICATIONS R/T TEST PANEL
618M-5/5A	ASI-221-2	NMN	NPN	ROCKWELL COLLINS	COMMUNICATIONS R/T TEST PANEL
618T-1/1B	ASI-209-1A	678P-1A	547-3914-000	ROCKWELL COLLINS	RADIO SET TEST HARNESS
618T-1/1B	ASI-427	678Z-1	548-8001-005	ROCKWELL COLLINS	TEST SET
618T-2/2B	ASI-209-1A	678P-1A	547-3914-000	ROCKWELL COLLINS	RADIO SET TEST HARNESS
618T-2/2B	ASI-427	678Z-1	548-8001-005	ROCKWELL COLLINS	TEST SET
618T-3/3B	ASI-209-1A	678P-1A	547-3914-000	ROCKWELL COLLINS	RADIO SET TEST HARNESS
618T-3/3B	ASI-427	678Z-1	548-8001-005	ROCKWELL COLLINS	TEST SET
621A-3	ASI-242R	NMN	NPN	ROCKWELL COLLINS	TEST PANEL
621A-6/6A	ASI-242	NMN	NPN	ROCKWELL COLLINS	TEST FIXTURE
621A-6/6A	ASI-242R	NMN	NPN	ROCKWELL COLLINS	TEST PANEL
627098	ASI-1004	CT8122	NPN	HONEYWELL (GARRETT)	PRESSURE SENSOR ELECTRONIC TEST PANEL
627098	ASI-1005	CT2506	NPN	HONEYWELL (GARRETT)	PRESSURE SENSOR PNEUMATIC TEST PANEL
627100	ASI-1004	CT8122	NPN	HONEYWELL (GARRETT)	PRESSURE SENSOR ELECTRONIC TEST PANEL
627100	ASI-1005	CT2506	NPN	HONEYWELL (GARRETT)	PRESSURE SENSOR PNEUMATIC TEST PANEL
628B-1()	ASI-300	973W-2	622-5058-001	ROCKWELL COLLINS	RADIO TEST SET
628B-1()	ASI-301	973W-3	622-6121-001	ROCKWELL COLLINS	RADIO TEST SET
628T-1/1B	ASI-209-1A	678P-1A	547-3914-000	ROCKWELL COLLINS	RADIO SET TEST HARNESS
628T-1/1B	ASI-700-4	NMN	NPN	ROCKWELL COLLINS	HF/VHF DISCRETE FUNCTION INTERFACE PANEL
628T-2/2A	ASI-209-1A	678P-1A	547-3914-000	ROCKWELL COLLINS	RADIO SET TEST HARNESS
628T-2/2A	ASI-6964-628T	NMN	642-6964-001	ROCKWELL COLLINS	628T-2() MAINTENANCE KIT
628T-2/2A	ASI-700-4	NMN	NPN	ROCKWELL COLLINS	HF/VHF DISCRETE FUNCTION INTERFACE PANEL
628T-2/2A	ASI-711	NMN	NPN	ROCKWELL COLLINS	500-OHM T-ATTENUATOR
628T-2/2A	ASI-712	NMN	NPN	ROCKWELL COLLINS	RF INJECTION PROBE
628T-2D	ASI-700-4	NMN	NPN	ROCKWELL COLLINS	HF/VHF DISCRETE FUNCTION INTERFACE PANEL
628T-2D	ASI-70-04C	NMN	NPN	ROCKWELL COLLINS	ARINC 753 HF/DL INTERFACE FIXTURE
628T-3/3A	ASI-209-1A	678P-1A	547-3914-000	ROCKWELL COLLINS	RADIO SET TEST HARNESS
628T-3/3A	ASI-711	NMN	NPN	ROCKWELL COLLINS	500-OHM T-ATTENUATOR
628T-3/3A	ASI-712	NMN	NPN	ROCKWELL COLLINS	RF INJECTION PROBE
628U-2/11	ASI-300	973W-2	622-5058-001	ROCKWELL COLLINS	RADIO TEST SET
628U-2/11	ASI-301	973W-3	622-6121-001	ROCKWELL COLLINS	RADIO TEST SET
639U-1	ASI-293	968X-1	622-4726-001	ROCKWELL COLLINS	639U-1 TEST PANEL
640B-1	ASI-2389-002	NMN	638-2389-001	ROCKWELL COLLINS	INTERCONNECT CABLE SET
640B-1	ASI-4015-186	NMN	647-4015-186	ROCKWELL COLLINS	INTERCONNECT CABLE SET

ASI TEST EQUIPMENT UNIT UNDER TEST (UUT) CROSS REFERENCE

UNIT TESTED	ASI MN	EQUIV MN	EQUIV PN	EQUIV OEM	DESCRIPTION
642C-1	ASI-366	NMN	NPN	ROCKWELL COLLINS	TEST PANEL
699Z-1	ASI-414	NMN	NPN	ROCKWELL COLLINS	TEST FIXTURE
714E-1	ASI-162	NMN	NPN	ROCKWELL COLLINS	714E-() TEST PANEL
714E-2()	ASI-162	NMN	NPN	ROCKWELL COLLINS	714E-() TEST PANEL
714E-3()	ASI-162	NMN	NPN	ROCKWELL COLLINS	714E-() TEST PANEL
714E-6()	ASI-162	NMN	NPN	ROCKWELL COLLINS	714E-() TEST PANEL
719S-1	ASI-321A	969N-1A	622-5532-001	ROCKWELL COLLINS	AUDIO TEST FIXTURE
719S-3	ASI-321A	969N-1A	622-5532-001	ROCKWELL COLLINS	AUDIO TEST FIXTURE
728U-2	ASI-323-3	966D-5B	622-9034-001	ROCKWELL COLLINS	RADIO SET TEST PANEL
728U-4	ASI-323-3	966D-5B	622-9034-001	ROCKWELL COLLINS	RADIO SET TEST PANEL
806A	ASI-221-1	968Y-1	622-4768-001	WILCOX	ARINC 547 VOR/ILS TEST SET
844A-1	ASI-327-3	977C-1	777-1358-001	ROCKWELL COLLINS	51RV-2B CARD TEST PANEL
860E-2	ASI-182	975D-2	622-3582-001	ROCKWELL COLLINS	DME TEST SET
860E-3	ASI-181	975D-1	787-6842-001	ROCKWELL COLLINS	860E-3 DME TEST CONTROL
860E-3	ASI-182	975D-2	622-3582-001	ROCKWELL COLLINS	DME TEST SET
860E-3	ASI-8405-001	NMN	791-8405-001	ROCKWELL COLLINS	860E-3 MAINTENANCE KIT
860E-4	ASI-182	975D-2	622-3582-001	ROCKWELL COLLINS	DME TEST SET
860E-4	ASI-2235-001	NMN	621-2235-001	ROCKWELL COLLINS	860E-4/5 MAINTENANCE KIT
860E-5	ASI-182	975D-2	622-3582-001	ROCKWELL COLLINS	DME TEST SET
860E-5	ASI-2235-001	NMN	621-2235-001	ROCKWELL COLLINS	860E-4/5 MAINTENANCE KIT
860F-1	ASI-194	NMN	NPN	ROCKWELL COLLINS	RADIO ALTIMETER TEST SET (PANEL MOUNT)
860F-1	ASI-203	980N-1	522-4610-004	ROCKWELL COLLINS	RADIO ALTIMETER TEST SET
860F-1	ASI-210	NMN	NPN	ROCKWELL COLLINS	RADIO ALTIMETER SYSTEM RAMP TEST SET
860F-1	ASI-237	NMN	NPN	ROCKWELL COLLINS	RADIO ALTIMETER TEST FIXTURE (BOX MOUNT)
860F-1	ASI-238	NMN	NPN	ROCKWELL COLLINS	TRANSMITTER ALIGNMENT TOOL
860F-1	ASI-240	NMN	NPN	ROCKWELL COLLINS	RF CABLE
860F-2	ASI-200-20	NMN	NPN	ROCKWELL COLLINS	ASI-2000 PLUG-IN ADAPTER
860F-2	ASI-299	NMN	828-8249-001	ROCKWELL COLLINS	PRO LINE ALT TEST PANEL
860F-2	ASI-CTS-10	CTS-10	622-4561-00	ROCKWELL COLLINS	UNIVERSAL ATR BREAKOUT BOX
860F-4	ASI-194	NMN	NPN	ROCKWELL COLLINS	RADIO ALTIMETER TEST SET (PANEL MOUNT)
860F-4	ASI-203	980N-1	522-4610-004	ROCKWELL COLLINS	RADIO ALTIMETER TEST SET
860F-4	ASI-210	NMN	NPN	ROCKWELL COLLINS	RADIO ALTIMETER SYSTEM RAMP TEST SET
860F-4	ASI-237	NMN	NPN	ROCKWELL COLLINS	RADIO ALTIMETER TEST FIXTURE (BOX MOUNT)
860F-4	ASI-238	NMN	NPN	ROCKWELL COLLINS	TRANSMITTER ALIGNMENT TOOL
860F-4	ASI-239	NMN	635-6250-001	ROCKWELL COLLINS	SPECIAL WRENCH
860F-4	ASI-240	NMN	NPN	ROCKWELL COLLINS	RF CABLE
860F-4	ASI-241	MST-901	622-6100-001	ROCKWELL COLLINS	MICROPROCESSOR SYSTEM TEST SET ADAPTER
860F-4	ASI-719	NMN	NPN	ROCKWELL COLLINS	PULSE GEN TEST BOX
8-930-3	ASI-604-2	NMN	NPN	CRANE AEROSPACE (ELDEC)	BATTERY CHARGER TEST SET
899L-1	ASI-225	NMN	NPN	ROCKWELL COLLINS	TEST ADAPTER INTERFACE
899L-1	ASI-226	514M-2	622-7082-001	ROCKWELL COLLINS	INTERFACE PANEL
899P-1	ASI-CTS-10	CTS-10	622-4561-00	ROCKWELL COLLINS	UNIVERSAL ATR BREAKOUT BOX
913K-1/1A	ASI-204	972S-1	622-1626-001	ROCKWELL COLLINS	AUTOPILOT RAMP TEST SET
913K-1/1A	ASI-205	972S-2	622-1668-001	ROCKWELL COLLINS	AP-106/107 TEST PANEL
914F-1	ASI-366	NMN	NPN	ROCKWELL COLLINS	TEST PANEL
914G-8/9/11	ASI-405	969L-1	635-7420-001	ROCKWELL COLLINS	914G-8/9/11 TEST PANEL
938J-1	ASI-226	514M-2	622-7082-001	ROCKWELL COLLINS	INTERFACE PANEL
938Y-1	ASI-226	514M-2	622-7082-001	ROCKWELL COLLINS	INTERFACE PANEL
951A-1	ASI-327-3	977C-1	777-1358-001	ROCKWELL COLLINS	51RV-2B CARD TEST PANEL
951A-1	ASI-327-4	977D-1	777-1359-001	ROCKWELL COLLINS	51RV-2B/618M-2 CARD TEST PANEL
959W-1	ASI-2389-002	NMN	638-2389-001	ROCKWELL COLLINS	INTERCONNECT CABLE SET
959W-1	ASI-4015-186	NMN	647-4015-186	ROCKWELL COLLINS	INTERCONNECT CABLE SET
998M-1	ASI-226	514M-2	622-7082-001	ROCKWELL COLLINS	INTERFACE PANEL
AAC-200/220	ASI-338-1	CTS-201	622-4281-001	ROCKWELL COLLINS	HF SYSTEM INTERCONNECT TEST SET
AAC-200/220	ASI-338-2	CTS-201	622-4282-001	ROCKWELL COLLINS	ANTENNA SIMULATOR
AAC-200/220	ASI-338-3	CTS-202	622-4283-001	ROCKWELL COLLINS	TRANSCEIVER-PA TEST PANEL
AAC-200/220	ASI-338-4	CTS-203	622-4285-001	ROCKWELL COLLINS	COUPLER LOGIC TEST PANEL
AAC-85	ASI-CTS-10	CTS-10	622-4561-00	ROCKWELL COLLINS	UNIVERSAL ATR BREAKOUT BOX
AAP-850	ASI-255	NMN	NPN	ROCKWELL COLLINS	AAP TEST SET
ADC-80	ASI-CTS-10	CTS-10	622-4561-00	ROCKWELL COLLINS	UNIVERSAL ATR BREAKOUT BOX
ADC-80()	ASI-294-1	970D-2	622-3304-001	ROCKWELL COLLINS	AIR DATA TEST SET
ADC-80()	ASI-294-2	970D-2A	622-8624-001	ROCKWELL COLLINS	AIR DATA TEST SET
ADC-80()	ASI-415-1	970D-1A	622-5811-001	ROCKWELL COLLINS	ADS AIR DATA TEST PANEL
ADC-81	ASI-CTS-10	CTS-10	622-4561-00	ROCKWELL COLLINS	UNIVERSAL ATR BREAKOUT BOX
ADC-81A	ASI-294-1	970D-2	622-3304-001	ROCKWELL COLLINS	AIR DATA TEST SET
ADC-81A	ASI-294-2	970D-2A	622-8624-001	ROCKWELL COLLINS	AIR DATA TEST SET
ADC-81A	ASI-415-1	970D-1A	622-5811-001	ROCKWELL COLLINS	ADS AIR DATA TEST PANEL
ADC-82	ASI-CTS-10	CTS-10	622-4561-00	ROCKWELL COLLINS	UNIVERSAL ATR BREAKOUT BOX
ADC-82()	ASI-294-1	970D-2	622-3304-001	ROCKWELL COLLINS	AIR DATA TEST SET
ADC-82()	ASI-294-2	970D-2A	622-8624-001	ROCKWELL COLLINS	AIR DATA TEST SET
ADC-82A	ASI-415-1	970D-1A	622-5811-001	ROCKWELL COLLINS	ADS AIR DATA TEST PANEL
ADC-85()	ASI-294-2	970D-2A	622-8624-001	ROCKWELL COLLINS	AIR DATA TEST SET
ADC-850()	ASI-294-2	970D-2A	622-8624-001	ROCKWELL COLLINS	AIR DATA TEST SET
ADC-86()	ASI-294-2	970D-2A	622-8624-001	ROCKWELL COLLINS	AIR DATA TEST SET
ADF-462	ASI-135	NMN	NPN	ROCKWELL COLLINS	PRO LINE ADF TEST PANEL

ASI TEST EQUIPMENT UNIT UNDER TEST (UUT) CROSS REFERENCE

UNIT TESTED	ASI MN	EQUIV MN	EQUIV PN	EQUIV OEM	DESCRIPTION
ADF-462	ASI-185	970G-1	622-2854-001	ROCKWELL COLLINS	ADF-462 TEST SET
ADF-462	ASI-200-10	NMN	NPN	ROCKWELL COLLINS	ASI-2000 PLUG-IN ADAPTER
ADF-462	ASI-61	NMN	NPN	ROCKWELL COLLINS	ADF LOOP ANTENNA SIMULATOR
ADF-462	ASI-61W	970W-1	622-3099-001	ROCKWELL COLLINS	ADF LOOP ANTENNA SIMULATOR
ADF-60	ASI-185	970G-1	622-2854-001	ROCKWELL COLLINS	ADF-60() TEST SET
ADF-60	ASI-200-10	NMN	NPN	ROCKWELL COLLINS	ASI-2000 PLUG-IN ADAPTER
ADF-60	ASI-61	NMN	NPN	ROCKWELL COLLINS	ADF BEARING SIMULATOR
ADF-60	ASI-61W	970W-1	622-3099-001	ROCKWELL COLLINS	ADF LOOP ANTENNA SIMULATOR
ADF-700	ASI-700-2	NMN	NPN	ROCKWELL COLLINS	ADF/GLU/ILS/VOR D.F.I.U.
ADF-900	ASI-700-2	NMN	NPN	ROCKWELL COLLINS	ADF/GLU/ILS/VOR D.F.I.U.
ADI-44V	ASI-167	978F-2S	522-3498-000	ROCKWELL COLLINS	SYNCHRO SIMULATOR
ADI-44V	ASI-191	978F-1D	522-3424-000	ROCKWELL COLLINS	INSTRUMENT TEST SET
ADI-55V	ASI-167	978F-2S	522-3498-000	ROCKWELL COLLINS	SYNCHRO SIMULATOR
ADI-55V	ASI-40Y-33	440Y-33	787-6142-001	ROCKWELL COLLINS	980L-1 PLUG-IN ADAPTER
ADI-55V-1	ASI-40Y-33	440Y-33	787-6142-001	ROCKWELL COLLINS	980L-1 PLUG-IN ADAPTER
ADI-55V-2	ASI-167	978F-2S	522-3498-000	ROCKWELL COLLINS	SYNCHRO SIMULATOR
ADI-55V-2	ASI-40Y-33	440Y-33	787-6142-001	ROCKWELL COLLINS	980L-1 PLUG-IN ADAPTER
ADI-70()	ASI-167	978F-2S	522-3498-000	ROCKWELL COLLINS	SYNCHRO SIMULATOR
ADI-77()	ASI-167	978F-2S	522-3498-000	ROCKWELL COLLINS	SYNCHRO SIMULATOR
ADI-77()	ASI-CTS-11A	CTS-11A	622-6823-001	ROCKWELL COLLINS	ADI-77 INSTRUMENT TEST SET
ADI-84()	ASI-167	978F-2S	522-3498-000	ROCKWELL COLLINS	SYNCHRO SIMULATOR
ADI-84()	ASI-429-1	NMN	NPN	ROCKWELL COLLINS	TEST ADAPTER PANEL
ADI-84()	ASI-429-2	NMN	NPN	ROCKWELL COLLINS	BREAKOUT BOX
ADI-85()	ASI-CTS-11	CTS-11	622-5380-001	ROCKWELL COLLINS	ADI-85 INSTRUMENT TEST SET
ADS-65()	ASI-381	CTS-61	622-6317-001	ROCKWELL COLLINS	AIR DATA SENSOR TEST PANEL
ADS-80	ASI-415-1	970D-1A	622-5811-001	ROCKWELL COLLINS	ADS AIR DATA TEST PANEL
ADS-81	ASI-415-1	970D-1A	622-5811-001	ROCKWELL COLLINS	ADS AIR DATA TEST PANEL
ADS-82	ASI-415-1	970D-1A	622-5811-001	ROCKWELL COLLINS	ADS AIR DATA TEST PANEL
AHC-85	ASI-354	NMN	638-0239-001	ROCKWELL COLLINS	AHC-85 DUAL MULTI SENSOR TEST PANEL
AHC-85	ASI-386	NMN	641-5834-003	ROCKWELL COLLINS	BURN-IN PANEL
AHC-85	ASI-390	NMN	NPN	ROCKWELL COLLINS	STRAPPING SWITCH ASSY
AHC-85	ASI-391-1	NMN	NPN	ROCKWELL COLLINS	INTERGRATION INTERFACE PANEL
AHC-85	ASI-391-2	NMN	NPN	ROCKWELL COLLINS	INTERGRATION CABLE ADAPTER
AHC-85	ASI-419	NMN	641-5955-001	ROCKWELL COLLINS	A7 TEST FIXTURE
AHC-85	ASI-CTS-10	CTS-10	622-4561-00	ROCKWELL COLLINS	UNIVERSAL ATR BREAKOUT BOX
AIU-4000	ASI-248	NMN	NPN	ROCKWELL COLLINS	TEST PANEL
AL-101	ASI-203	980N-1	522-4610-004	ROCKWELL COLLINS	ALTIMETER RAMP TEST SET
AL-101	ASI-210	NMN	NPN	ROCKWELL COLLINS	AL-101 SYSTEM RAMP TEST FIXTURE
AL-101A	ASI-203	980N-1	522-4610-004	ROCKWELL COLLINS	ALTIMETER RAMP TEST SET
ALA-51A	ASI-175	AMT-51A	2037028-5103	HONEYWELL (BENDIX)	RADIO ALTIMETER RAMP TEST SET
ALA-51A	ASI-199	ALT-51A	2037120-0501	HONEYWELL (BENDIX)	RADIO ALTIMETER TEST SET
ALA-52A	ASI-175-2	AMT-52A	2041595-5201	HONEYWELL (BENDIX)	PORTABLE ALTOMETER TEST SET
ALA-52A	ASI-802	ALT-52A	2041475-5201	HONEYWELL (BENDIX)	RADIO ALTIMETER TEST PANEL
ALI-55	ASI-299	NMN	828-8249-001	ROCKWELL COLLINS	ALT TEST PANEL
ALI-80()	ASI-415-1	970D-1A	622-5811-001	ROCKWELL COLLINS	ADS AIR DATA TEST PANEL
ALT-1000	ASI-299	NMN	NPN	ROCKWELL COLLINS	ALT-4000/55 TEST PANEL
ALT-4000	ASI-299	NMN	NPN	ROCKWELL COLLINS	ALT-4000/55 TEST PANEL
ALT-4000	ASI-CTS-10	CTS-10	622-4561-00	ROCKWELL COLLINS	UNIVERSAL ATR BREAKOUT BOX
ALT-50()	ASI-200-20	NMN	NPN	ROCKWELL COLLINS	ASI-2000 PLUG-IN ADAPTER
ALT-50A	ASI-299	NMN	NPN	ROCKWELL COLLINS	ALT-4000/55 TEST PANEL
ALT-50A	ASI-CTS-10	CTS-10	622-4561-00	ROCKWELL COLLINS	UNIVERSAL ATR BREAKOUT BOX
ALT-55/55A	ASI-200-20	NMN	NPN	ROCKWELL COLLINS	RADIO ALTIMETER TEST PANEL
ALT-55B	ASI-200-20	NMN	NPN	ROCKWELL COLLINS	ASI-2000 PLUG-IN ADAPTER
ALT-55B	ASI-299	NMN	NPN	ROCKWELL COLLINS	ALT-4000/55 TEST PANEL
ALT-55B	ASI-CTS-10	CTS-10	622-4561-00	ROCKWELL COLLINS	UNIVERSAL ATR BREAKOUT BOX
AM-3624/ARA-50	ASI-789	AN/ARM-102	522-4545-001	ROCKWELL COLLINS	DIRECTION FINDER GROUP TEST SET
AM-3624/ARA-50	ASI-789-1	TS-2544/ARM-102	522-4817-001	ROCKWELL COLLINS	DIRECTION FINDER TEST SET
AM-3624/ARA-50	ASI-789-2	MT-3726/ARM-102	522-4818-001	ROCKWELL COLLINS	DIRECTION FINDER TEST SET MOUNT
AN/ARA-50	ASI-789	AN/ARM-102	522-4545-001	ROCKWELL COLLINS	DIRECTION FINDER GROUP TEST SET
AN/ARA-50	ASI-789-1	TS-2544/ARM-102	522-4817-001	ROCKWELL COLLINS	DIRECTION FINDER TEST SET
AN/ARA-50	ASI-789-2	MT-3726/ARM-102	522-4818-001	ROCKWELL COLLINS	DIRECTION FINDER TEST SET MOUNT
AN/ARC-159(V)	ASI-308-1	AN/ARM-165	623-5403-001	ROCKWELL COLLINS	RADIO SET TEST PANEL
AN/ARC-159(V)	ASI-308-2	AN/ARM-165A	622-2750-001	ROCKWELL COLLINS	RADIO SET TEST PANEL
AN/ARC-182(V)	ASI-300	973W-2	622-5058-001	ROCKWELL COLLINS	RADIO TEST SET
AN/ARC-182(V)	ASI-301	973W-3	622-6121-001	ROCKWELL COLLINS	RADIO TEST SET
AN/ARC-186	ASI-2389-002	NMN	638-2389-002	ROCKWELL COLLINS	INTERCONNECT CABLE SET
AN/ARC-186	ASI-2390-001	NMN	638-2390-001	ROCKWELL COLLINS	INTERCONNECT CABLE SET
AN/ARC-186	ASI-4015-186	NMN	647-4015-001	ROCKWELL COLLINS	INTERCONNECT CABLE SET
AN/ARC-186	ASI-6787-001	CTS-90	622-6787-001	ROCKWELL COLLINS	INTERCONNECT CABLE SET
AN/ARC-190(V)	ASI-323-21	966D-5A	622-7574-002	ROCKWELL COLLINS	RADIO SET TEST PANEL
AN/ARC-190(V)	ASI-323-3	966D-5B	622-9034-001	ROCKWELL COLLINS	RADIO SET TEST PANEL
AN/ARC-217(V)	ASI-777	TE-9210	822-1429-001	ROCKWELL COLLINS	HF-9000 SYSTEM TEST PANEL
AN/ARC-217(V)	ASI-778	TE-9400	622-9420-001	ROCKWELL COLLINS	EXTENDER KIT
AN/ARC-80	ASI-346-2	878L-1	522-3022-000	ROCKWELL COLLINS	AMPLIFIER TEST PANEL
AN/ARN-123	ASI-177-2	RNT-260A	4000951-6001	HONEYWELL (BENDIX)	VOR/ILS SYSTEM TEST PANEL

ASI TEST EQUIPMENT UNIT UNDER TEST (UUT) CROSS REFERENCE

UNIT TESTED	ASI MN	EQUIV MN	EQUIV PN	EQUIV OEM	DESCRIPTION
AN/ARN-127	ASI-177-2-04	RNT-260A	4000951-6004	HONEYWELL (BENDIX)	VOR/ILS SYSTEM TEST PANEL
AN/ARN-139(V)	ASI-226	514M-2	622-7082-001	ROCKWELL COLLINS	INTERFACE PANEL
AN/ARN-144(V)	ASI-376-1	966Y-2	622-6926-001	ROCKWELL COLLINS	VOR/ILS TEST PANEL
AN/ARN-147(V)	ASI-177-2-04	RNT-260A	4000951-6004	HONEYWELL (BENDIX)	VOR/ILS SYSTEM TEST PANEL
AN/ARN-147(V)	ASI-376-1	966Y-2	622-6926-001	ROCKWELL COLLINS	VOR/ILS TEST PANEL
AN/ARN-149(V)	ASI-375-1	970G-2	622-7345-001	ROCKWELL COLLINS	ADF TEST PANEL
AN/ARN-149(V)	ASI-61W	970W-1	622-3099-001	ROCKWELL COLLINS	ADF ANTENNA SIMULATOR
AN/ARN-83	ASI-201-1	AN/ARM-93	52204458-001	ROCKWELL COLLINS	ADF TEST SET
ANA-75B	ASI-804-1	DFT-75B	2041597-7501	HONEYWELL (BENDIX)	ADF ANTENNA TEST SET
ANS-31()	ASI-295	971K-1	522-2011-001	ROCKWELL COLLINS	AREA NAVIGATION SYSTEM TEST PANEL
ANT-1()	ASI-172	RDT-1B	2037737-0501	HONEYWELL (BENDIX)	ANT-1() RADAR ANTENNA TEST SET
ANT-152	ASI-188	NMN	NPN	ROCKWELL COLLINS	WXR DIGITAL WEATHER RADAR TEST PANEL
ANT-152	ASI-188-1	NMN	NPN	ROCKWELL COLLINS	WXR DIGITAL WEATHER RADAR TEST PANEL
ANT-1F/1G	ASI-172	RDT-1B	2037737-0501	HONEYWELL (BENDIX)	RADAR ANTENNA TEST PANEL
ANT-1S	ASI-169	RST-1A	2064746-0501	HONEYWELL (BENDIX)	STAB RAMP TEST SET
ANT-1S	ASI-172	RDT-1B	2037737-0501	HONEYWELL (BENDIX)	RADAR ANTENNA TEST PANEL
ANT-1T	ASI-153-1	ATT-1F	2038070-0501	HONEYWELL (BENDIX)	ANT-1T RADAR ANT TEST PANEL
ANT-1T	ASI-154-1	RCT-1F	2038326-0501	HONEYWELL (BENDIX)	RADAR SYSTEM TEST PANEL
ANT-1TB	ASI-153-2	ATT-1FB	2038270-0502	HONEYWELL (BENDIX)	ANT-1TB RADAR ANTENNA TEST PANEL
ANT-1TB	ASI-154-2	RCT-1FB	2041349-0102	HONEYWELL (BENDIX)	RDR-1FB RADAR SYSTEM TEST PANEL
ANT-1TB(M)	ASI-153-3	ATT-1FB	2038270-0503	HONEYWELL (BENDIX)	ANT-1TB(M) RADAR ANTENNA TEST PANEL
ANT-1TB(M)	ASI-154-2	RCT-1FB	2041349-0102	HONEYWELL (BENDIX)	RDR-1FB RADAR SYSTEM TEST PANEL
ANT-210	ASI-188-1	NMN	NPN	ROCKWELL COLLINS	WXR DIGITAL WEATHER RADAR TEST PANEL
ANT-212	ASI-188-1	NMN	NPN	ROCKWELL COLLINS	WXR DIGITAL WEATHER RADAR TEST PANEL
ANT-212D	ASI-188-1	NMN	NPN	ROCKWELL COLLINS	WXR DIGITAL WEATHER RADAR TEST PANEL
ANT-310	ASI-188-1	NMN	NPN	ROCKWELL COLLINS	WXR DIGITAL WEATHER RADAR TEST PANEL
ANT-310	ASI-188-2	NMN	NPN	ROCKWELL COLLINS	ANTENNA CALIBRATION/TEST FIXTURE
ANT-310A	ASI-188-1	NMN	NPN	ROCKWELL COLLINS	WXR DIGITAL WEATHER RADAR TEST PANEL
ANT-312	ASI-188-1	NMN	NPN	ROCKWELL COLLINS	WXR DIGITAL WEATHER RADAR TEST PANEL
ANT-312	ASI-188-2	NMN	NPN	ROCKWELL COLLINS	ANTENNA CALIBRATION/TEST FIXTURE
ANT-312A	ASI-188-1	NMN	NPN	ROCKWELL COLLINS	WXR DIGITAL WEATHER RADAR TEST PANEL
ANT-318	ASI-188-1	NMN	NPN	ROCKWELL COLLINS	WXR DIGITAL WEATHER RADAR TEST PANEL
ANT-318	ASI-188-2	NMN	NPN	ROCKWELL COLLINS	ANTENNA CALIBRATION/TEST FIXTURE
ANT-318A	ASI-188-1	NMN	NPN	ROCKWELL COLLINS	WXR DIGITAL WEATHER RADAR TEST PANEL
ANT-462A	ASI-278	969W-1	622-3874-001	ROCKWELL COLLINS	ADF ANTENNA TESTER
ANT-462B	ASI-278	969W-1	622-3874-001	ROCKWELL COLLINS	ADF ANTENNA TESTER
ANT-60A	ASI-278	969W-1	622-3874-001	ROCKWELL COLLINS	ADF ANTENNA TESTER
ANT-60B	ASI-278	969W-1	622-3874-001	ROCKWELL COLLINS	ADF ANTENNA TESTER
ANT-650A	ASI-278	969W-1	622-3874-001	ROCKWELL COLLINS	ADF ANTENNA TESTER
AP-106	ASI-204	972S-1	622-1626-001	ROCKWELL COLLINS	AUTOPILOT RAMP TEST SET
AP-106	ASI-205	972S-2	622-1668-001	ROCKWELL COLLINS	AUTOPILOT BENCH TEST PANEL
AP-107	ASI-204	972S-1	622-1626-001	ROCKWELL COLLINS	AUTOPILOT RAMP TEST SET
AP-107	ASI-205	972S-2	622-1668-001	ROCKWELL COLLINS	AUTOPILOT BENCH TEST PANEL
APA-80	ASI-286-1	CTS-82	622-4562-001	ROCKWELL COLLINS	AUTOPILOT TEST SET
APA-80	ASI-40Y-69A	440Y-69A	622-4088-001	ROCKWELL COLLINS	980L-1A PLUG-IN ADAPTER
APA-80	ASI-CTS-10	CTS-10	622-4561-00	ROCKWELL COLLINS	UNIVERSAL ATR BREAKOUT BOX
APC-65	ASI-40Y-76	440Y-76	622-6315-001	ROCKWELL COLLINS	980L-1A PLUG-IN ADAPTER
APC-65	ASI-CTS-10	CTS-10	622-4561-00	ROCKWELL COLLINS	UNIVERSAL ATR BREAKOUT BOX
APC-80	ASI-286	CTS-82	622-4562-001	ROCKWELL COLLINS	AUTOPILOT TEST SET
APC-80	ASI-40Y-68A	440Y-68A	622-4087-001	ROCKWELL COLLINS	980L-1A PLUG-IN ADAPTER
APC-80	ASI-CTS-10	CTS-10	622-4561-00	ROCKWELL COLLINS	UNIVERSAL ATR BREAKOUT BOX
APP-80	ASI-40Y-68A	440Y-68A	622-4087-001	ROCKWELL COLLINS	980L-1A PLUG-IN ADAPTER
APS-65	ASI-40Y-76	440Y-76	622-6315-001	ROCKWELL COLLINS	980L-1A PLUG-IN ADAPTER
AQU-2/2A	ASI-499-2	476E-4A	522-2698-004	ROCKWELL COLLINS	HSI TEST SET
AQU-2/2A	ASI-499-3	476E-4C	522-3547-000	ROCKWELL COLLINS	HSI TEST SET
AQU-4/4A	ASI-499-3	476E-4C	522-3547-000	ROCKWELL COLLINS	HSI TEST SET
ARN-83	ASI-201	AN/ARM-93	522-4458-001	ROCKWELL COLLINS	ADF SYSTEM TEST SET
ARN-83	ASI-201	477U-3	522-4458-002	ROCKWELL COLLINS	ADF SYSTEM TEST SET
ART-2000	ASI-783	NMN	NPN	HONEYWELL	RDR-2000/2100 RADAR SYSTEM TEST SET
ART-2100	ASI-783	NMN	NPN	HONEYWELL	RDR-2000/2100 RADAR SYSTEM TEST SET
AS-909/ARA-50	ASI-789	AN/ARM-102	522-4545-001	ROCKWELL COLLINS	DIRECTION FINDER GROUP TEST SET
AS-909/ARA-50	ASI-789-1	TS-2544/ARM-102	522-4817-001	ROCKWELL COLLINS	DIRECTION FINDER TEST SET
AS-909/ARA-50	ASI-789-2	MT-3726/ARM-102	522-4818-001	ROCKWELL COLLINS	DIRECTION FINDER TEST SET MOUNT
AT-102A	ASI-329-10	172H-10	522-4601-001	ROCKWELL COLLINS	ELECTRICAL DUMMY LOAD
AT-107	ASI-329-9	172H-17	777-1864-001	ROCKWELL COLLINS	ELECTRICAL DUMMY LOAD
AT-107	ASI-339	980H-6	777-1534-001	ROCKWELL COLLINS	ANTENNA COUPLER TEST SET
AT-133A/AT	ASI-360	NMN	NPN	HONEYWELL (BENDIX)	RDR RADAR SYSTEM TEST PANEL
AT-143A	ASI-360	NMN	NPN	HONEYWELL (BENDIX)	RDR RADAR SYSTEM TEST PANEL
AT-434A	ASI-810-1	92AF-1	01-0216-00	HONEYWELL (BENDIX)	SERIES III / FLITELINE ADF SYSTEM TEST PANEL
AVQ-10	ASI-262	NMN	NPN	HONEYWELL (RCA/SPERRY)	AVQ-10 SYSTEM TEST PANEL
AVQ-30	ASI-270-1	NMN	MI-592189	HONEYWELL (RCA/SPERRY)	AVQ-30 RADAR R-T MODULE TEST PANEL
AVQ-30	ASI-270-2	NMN	MI-592188	HONEYWELL (RCA/SPERRY)	AVQ-30 RADAR ANTENNA TEST PANEL
AVQ-30	ASI-270-3	NMN	MI-592187	HONEYWELL (RCA/SPERRY)	AVQ-30 RADAR INDICATOR TEST PANEL
AVQ-30	ASI-270-4	NMN	MI-592186	HONEYWELL (RCA/SPERRY)	AVQ-30 RADAR R-T TEST PANEL
BCA-770	ASI-158	NMN	637-7656-001	ROCKWELL COLLINS	UNIVERSAL HIGH POT TESTER

ASI TEST EQUIPMENT UNIT UNDER TEST (UUT) CROSS REFERENCE

UNIT TESTED	ASI MN	EQUIV MN	EQUIV PN	EQUIV OEM	DESCRIPTION
BCA-770	ASI-158-1	NMN	637-7656-100	ROCKWELL COLLINS	UNIVERSAL HIGH POT TESTER
BCA-770	ASI-404-1	NMN	676-3923-001	ROCKWELL COLLINS	BCA SERVO TEST PANEL
BDI-36	ASI-123	NMN	NPN	ROCKWELL COLLINS	BDI-36 TEST PANEL
BDI-36	ASI-167	978F-2S	522-3498-000	ROCKWELL COLLINS	SYNCHRO SIMULATOR
BDI-36	ASI-187	970E-1	622-2914-001	ROCKWELL COLLINS	RMI TEST PANEL
BIA-32	ASI-121	NMN	NPN	ROCKWELL COLLINS	BIA-32 TEST PANEL
BIA-32	ASI-200-19	NMN	NPN	ROCKWELL COLLINS	ASI-2000 PLUG-IN ADAPTER
BIA-32	ASI-CTS-10	CTS-10	622-4561-00	ROCKWELL COLLINS	UNIVERSAL ATR BREAKOUT BOX
BRG-40	ASI-120	NMN	NPN	ROCKWELL COLLINS	TCN-40 TEST PANEL
BRG-40	ASI-200-22	NMN	NPN	ROCKWELL COLLINS	ASI-2000 PLUG-IN ADAPTER
BRG-40	ASI-CTS-10	CTS-10	622-4561-00	ROCKWELL COLLINS	UNIVERSAL ATR BREAKOUT BOX
C-10048	ASI-177-2	RNT-260A	4000951-6002	HONEYWELL (BENDIX)	VOR/ILS SYSTEM TEST PANEL
C-10049	ASI-177-2	RNT-260A	4000951-6002	HONEYWELL (BENDIX)	VOR/ILS SYSTEM TEST PANEL
C-10124	ASI-177-2-04	RNT-260A	4000951-6004	HONEYWELL (BENDIX)	VOR/ILS SYSTEM TEST PANEL
C-10125	ASI-177-2-04	RNT-260A	4000951-6004	HONEYWELL (BENDIX)	VOR/ILS SYSTEM TEST PANEL
C-10218	ASI-177-2-04	RNT-260A	4000951-6004	HONEYWELL (BENDIX)	VOR/ILS SYSTEM TEST PANEL
C-10319A	ASI-300	973W-2	622-5058-001	ROCKWELL COLLINS	RADIO TEST SET
C-10319A	ASI-301	973W-3	622-6121-001	ROCKWELL COLLINS	RADIO TEST SET
C-10490	ASI-177-2	RNT-260A	3604031-0501	HONEYWELL (BENDIX)	VOR/ILS SYSTEM TEST PANEL
C-10776A	ASI-300	973W-2	622-5058-001	ROCKWELL COLLINS	RADIO TEST SET
C-10776A	ASI-301	973W-3	622-6121-001	ROCKWELL COLLINS	RADIO TEST SET
C-10828()	ASI-323-21	966D-5A	622-7574-002	ROCKWELL COLLINS	RADIO SET TEST PANEL
C-10828()	ASI-323-3	966D-5B	622-9034-001	ROCKWELL COLLINS	RADIO SET TEST PANEL
C-10994()	ASI-226	514M-2	622-7082-001	ROCKWELL COLLINS	INTERFACE PANEL
C-11029()	ASI-2389-002	NMN	638-2389-002	ROCKWELL COLLINS	INTERCONNECT CABLE SET
C-11029()	ASI-4015-186	NMN	647-4015-001	ROCKWELL COLLINS	INTERCONNECT CABLE SET
C-11029()	ASI-6787-001	CTS-90	622-6787-001	ROCKWELL COLLINS	INTERCONNECT CABLE SET
C-11131	ASI-300	973W-2	622-5058-001	ROCKWELL COLLINS	RADIO TEST SET
C-11131	ASI-301	973W-3	622-6121-001	ROCKWELL COLLINS	RADIO TEST SET
C-11443	ASI-323-21	966D-5A	622-7574-002	ROCKWELL COLLINS	RADIO SET TEST PANEL
C-11443	ASI-323-3	966D-5B	622-9034-001	ROCKWELL COLLINS	RADIO SET TEST PANEL
C-11814	ASI-323-21	966D-5A	622-7574-002	ROCKWELL COLLINS	RADIO SET TEST PANEL
C-11814	ASI-323-3	966D-5B	622-9034-001	ROCKWELL COLLINS	RADIO SET TEST PANEL
C-14/A/D	ASI-275-1	T307976	NPN	HONEYWELL (SPERRY)	C14 PRELIMINARY AND FINAL TEST PANEL
C-14/A/D	ASI-275-2	T307977	NPN	HONEYWELL (SPERRY)	DG-401 CALIBRATION FIXTURE
C-14/A/D	ASI-407-1	T307702-4	NPN	HONEYWELL (SPERRY)	POWER SUPPLY AND READOUT FIXTURE
C-14/A/D	ASI-408	T322861	NPN	HONEYWELL (SPERRY)	C-14D BASE TEST FIXTURE
C-14/A/D	ASI-409	T322780	NPN	HONEYWELL (SPERRY)	C14 AMPLIFIER/SYNCHRONIZER TEST FIXTURE
C-14/A/D	ASI-410	T307967	NPN	HONEYWELL (SPERRY)	FLUX VALVE HEADING SIMULATOR
C-6/A/D/F/H/J	ASI-115	NMN	NPN	HONEYWELL (SPERRY)	C-6() INDICATOR TEST PANEL
C-6899	ASI-201-1	AN/ARM-93	522-4458-001	ROCKWELL COLLINS	ADF TEST SET
C-6B	ASI-115	NMN	NPN	HONEYWELL (SPERRY)	C-6() INDICATOR TEST PANEL
C-6E	ASI-115	NMN	NPN	HONEYWELL (SPERRY)	C-6() INDICATOR TEST PANEL
C-9577	ASI-308-2	AN/ARM-165A	622-2750-001	ROCKWELL COLLINS	RADIO TEST SET
C-9815	ASI-308-2	AN/ARM-165A	622-2750-001	ROCKWELL COLLINS	RADIO TEST SET
C-9816	ASI-308-2	AN/ARM-165A	622-2750-001	ROCKWELL COLLINS	RADIO TEST SET
C-9817	ASI-308-2	AN/ARM-165A	622-2750-001	ROCKWELL COLLINS	RADIO TEST SET
C-9818	ASI-308-2	AN/ARM-165A	622-2750-001	ROCKWELL COLLINS	RADIO TEST SET
C-9946	ASI-308-2	AN/ARM-165A	622-2750-001	ROCKWELL COLLINS	RADIO TEST SET
C-9951	ASI-308-2	AN/ARM-165A	622-2750-001	ROCKWELL COLLINS	RADIO TEST SET
C-9952	ASI-308-2	AN/ARM-165A	622-2750-001	ROCKWELL COLLINS	RADIO TEST SET
C-9954	ASI-308-2	AN/ARM-165A	622-2750-001	ROCKWELL COLLINS	RADIO TEST SET
CAD-31	ASI-129	NMN	NPN	ROCKWELL COLLINS	PRO LINE CONTROL ADAPTER TEST PANEL
CAD-31	ASI-200-4	NMN	NPN	ROCKWELL COLLINS	ASI-2000 PLUG-IN ADAPTER
CAD-62	ASI-129	NMN	NPN	ROCKWELL COLLINS	PRO LINE CONTROL ADAPTER TEST PANEL
CAD-62	ASI-200-4	NMN	NPN	ROCKWELL COLLINS	ASI-2000 PLUG-IN ADAPTER
CAD-870	ASI-132	NMN	NPN	ROCKWELL COLLINS	PRO LINE RAC / CAD TEST PANEL
CAD-870	ASI-200-18	NMN	NPN	ROCKWELL COLLINS	ASI-2000 PLUG-IN ADAPTER
CAD-870G	ASI-124	NMN	NPN	ROCKWELL COLLINS	CAD-870G TEST PANEL
CAD-870G	ASI-200-14	NMN	NPN	ROCKWELL COLLINS	ASI-2000 PLUG-IN ADAPTER
CAD-870G	ASI-CTS-10	CTS-10	622-4561-00	ROCKWELL COLLINS	UNIVERSAL ATR BREAKOUT BOX
CAD-92	ASI-200-4	NMN	NPN	ROCKWELL COLLINS	ASI-2000 PLUG-IN ADAPTER
CAN-73BC/BF	ASI-202-2	DFT-73C1	2070555-0501	HONEYWELL (BENDIX)	ASF SYSTEM TEST PANEL
CAN-73FB/FC/FD	ASI-202	DFT-73AA	2064943-0501	HONEYWELL (BENDIX)	ADF SYSTEM TEST PANEL
CAN-73FB/FC/FD	ASI-202-1	DFT-73AA	2064943-0501	HONEYWELL (BENDIX)	ADF SYSTEM TEST PANEL
CC-2024	ASI-426	RCT-1500A	3614129-1501	HONEYWELL (BENDIX)	RADAR SYSTEM TEST PANEL
CCA-4A	ASI-760	PPT-4A	2041591-0401	HONEYWELL (BENDIX)	RADAR INDICATOR TEST PANEL
CCU-65	ASI-412	CTS-64	622-6459-001	ROCKWELL COLLINS	MCS-65 COMPASS SYSTEM TEST PANEL
CD-402A	ASI-810-2	92CN-1	01-0217-00	HONEYWELL (BENDIX)	SERIES III / FLITELINE COM/NAV SYSTEM TEST PANEL
CD-402B	ASI-810-2	92CN-1	01-0217-00	HONEYWELL (BENDIX)	SERIES III / FLITELINE COM/NAV SYSTEM TEST PANEL
CD-402C	ASI-810-2	92CN-1	01-0217-00	HONEYWELL (BENDIX)	SERIES III / FLITELINE COM/NAV SYSTEM TEST PANEL
CD-412A	ASI-810-2	92CN-1	01-0217-00	HONEYWELL (BENDIX)	SERIES III / FLITELINE COM/NAV SYSTEM TEST PANEL
CD-412B	ASI-810-2	92CN-1	01-0217-00	HONEYWELL (BENDIX)	SERIES III / FLITELINE COM/NAV SYSTEM TEST PANEL
CD-413B	ASI-810-2	92CN-1	01-0217-00	HONEYWELL (BENDIX)	SERIES III / FLITELINE COM/NAV SYSTEM TEST PANEL
CD-422B	ASI-810-3	92XD-1	01-0218-00	HONEYWELL (BENDIX)	SERIES III / FLITELINE DME/XPDR SYSTEM TEST PANEL

ASI TEST EQUIPMENT UNIT UNDER TEST (UUT) CROSS REFERENCE

UNIT TESTED	ASI MN	EQUIV MN	EQUIV PN	EQUIV OEM	DESCRIPTION
CD-432A	ASI-810-1	92AF-1	01-0216-00	HONEYWELL (BENDIX)	SERIES III / FLITELINE ADF SYSTEM TEST PANEL
CD-432B	ASI-810-1	92AF-1	01-0216-00	HONEYWELL (BENDIX)	SERIES III / FLITELINE ADF SYSTEM TEST PANEL
CDF-552	ASI-810-1	92AF-1	01-0216-00	HONEYWELL (BENDIX)	SERIES III / FLITELINE ADF SYSTEM TEST PANEL
CDM-451	ASI-810-3	92XD-1	01-0218-00	HONEYWELL (BENDIX)	SERIES III / FLITELINE DME/XPDR SYSTEM TEST PANEL
CHP-850()	ASI-254	NMN	NPN	ROCKWELL COLLINS	CHP-850() TEST SET
CIU-906	ASI-356-1	NMN	830-1212-001	ROCKWELL COLLINS	CIU-906 TEST SET (REQ ASI-356-2 FOR OPERATION)
CIU-906	ASI-356-2	NMN	830-3915-001	ROCKWELL COLLINS	CIU-906 TEST POD (REQ ASI-356-1 FOR OPERATION)
CIU-906	ASI-762	NMN	830-6309-001	ROCKWELL COLLINS	CIU-906 TEST PANEL
CMU-900	ASI-746-1	NMN	676-7387-003	ROCKWELL COLLINS	RAM BUFFER CARD
CMU-900	ASI-747	NMN	676-7385-001	ROCKWELL COLLINS	BUS BUFFER CARD
CMU-900	ASI-765	NMN	099-4421-000	ROCKWELL COLLINS	CMU-900 POWER SUPPLY TEST SET
CMU-900	ASI-766	NMN	830-8625-001	ROCKWELL COLLINS	CMU-900 TEST PANEL
CMU-900	ASI-767	NMN	NPN	ROCKWELL COLLINS	CMU-900 JTAG ASSY
CN1506A	ASI-426	RCT-1500A	3614129-1501	HONEYWELL (BENDIX)	RADAR SYSTEM TEST PANEL
CN-261A	ASI-177-2-04	RNT-260A	4000951-6004	HONEYWELL (BENDIX)	VOR/ILS SYSTEM TEST PANEL
CN-268A	ASI-177-2-04	RNT-260A	4000951-6004	HONEYWELL (BENDIX)	VOR/ILS SYSTEM TEST PANEL
CN-269A	ASI-177-2-04	RNT-260A	4000951-6004	HONEYWELL (BENDIX)	VOR/ILS SYSTEM TEST PANEL
CNA-73A	ASI-202-1	DFT-73AA	2064943-0501	HONEYWELL (BENDIX)	ADF SYSTEM TEST PANEL
CNA-73B/BB	ASI-202-1	DFT-73AA	2064943-0501	HONEYWELL (BENDIX)	ADF SYSTEM TEST PANEL
CNA-73C/CB	ASI-202-1	DFT-73AA	2064943-0501	HONEYWELL (BENDIX)	ADF SYSTEM TEST PANEL
CNA-73D	ASI-202-1	DFT-73AA	2064943-0501	HONEYWELL (BENDIX)	ADF SYSTEM TEST PANEL
CNA-73E	ASI-202-1	DFT-73AA	2064943-0501	HONEYWELL (BENDIX)	ADF SYSTEM TEST PANEL
CON-1()	ASI-172	RDT-1B	2037737-0501	HONEYWELL (BENDIX)	RADAR ANTENNA TEST PANEL
CON-1FB	ASI-244-1	PPT-1FB	2041350-0101	HONEYWELL (BENDIX)	RADAR INDICATOR TEST PANEL
CON-1R	ASI-154-1	RCT-1F	2038326-0501	HONEYWELL (BENDIX)	RDR-1F RADAR SYSTEM TEST PANEL
CON-1RB	ASI-154-2	RCT-1FB	2041349-0102	HONEYWELL (BENDIX)	RDR-1FB RADAR SYSTEM TEST PANEL
CON-1RB	ASI-252-1	COT-1FB	2041348-0102	HONEYWELL (BENDIX)	RADAR CONTROLLER TEST PANEL
CON-1RB(M)	ASI-252-1	COT-1FB	2041348-0102	HONEYWELL (BENDIX)	RADAR CONTROLLER TEST PANEL
CON-1S	ASI-154-1	RCT-1F	2038326-0501	HONEYWELL (BENDIX)	RDR-1F RADAR SYSTEM TEST PANEL
CON-1SB	ASI-154-2	RCT-1FB	2041349-0102	HONEYWELL (BENDIX)	RDR-1FB RADAR SYSTEM TEST PANEL
CON-1SB	ASI-252-1	COT-1FB	2041348-0102	HONEYWELL (BENDIX)	RADAR CONTROLLER TEST PANEL
CON-1SB(M)	ASI-154-2	RCT-1FB	2041349-0102	HONEYWELL (BENDIX)	RDR-1FB RADAR SYSTEM TEST PANEL
CON-1SB(M)	ASI-252-1	COT-1FB	2041348-0102	HONEYWELL (BENDIX)	RADAR CONTROLLER TEST PANEL
CON-1TB	ASI-244-2	PPT-1FB	2041350-0102	HONEYWELL (BENDIX)	RADAR INDICATOR TEST PANEL
CON-1TB(M)	ASI-154-2	RCT-1FB	2041349-0102	HONEYWELL (BENDIX)	RDR-1FB RADAR SYSTEM TEST PANEL
CON-1TB(M)	ASI-244-2	PPT-1FB	2041350-0102	HONEYWELL (BENDIX)	RADAR INDICATOR TEST PANEL
CON-4A/4B	ASI-252-2	COT-4A	2041593-0401	HONEYWELL (BENDIX)	RADAR CONTROLLER TEST PANEL
CON-4A/4B	ASI-742	RCT-4A	2041589-0401	HONEYWELL (BENDIX)	RADAR SYSTEM TEST PANEL
CP-2024	ASI-323-21	966D-5A	622-7574-002	ROCKWELL COLLINS	RADIO SET TEST PANEL
CP-2024	ASI-323-3	966D-5B	622-9034-001	ROCKWELL COLLINS	RADIO SET TEST PANEL
CPA-83A	ASI-422	CPT-83A	2041065-8301	ROCKWELL COLLINS	GPW SYSTEM TEST PANEL
CPL-920D	ASI-207-1	172H-18	622-0180-001	ROCKWELL COLLINS	SHUNT DUMMY ANTENNA
CPL-920D	ASI-207-10	NMN	989-2146-001	ROCKWELL COLLINS	90 DEGREE PHASE SHIFT NETWORK
CPL-920D	ASI-207-11	NMN	989-2146-002	ROCKWELL COLLINS	0 DEGREE POWER DIVIDER
CPL-920D	ASI-207-12	NMN	989-2146-007	ROCKWELL COLLINS	RF TEST CABLE
CPL-920D	ASI-207-13	NMN	989-2443-001	ROCKWELL COLLINS	COAX TEST ADAPTER
CPL-920D	ASI-207-3	NMN	NPN	ROCKWELL COLLINS	RF HIGH VOLTAGE TEST FIXTURE
CPL-920D	ASI-207-4	967R-2	822-1176-001	ROCKWELL COLLINS	CONTROL CARD TEST SET
CPL-920D	ASI-207-5	TE1	752-8896-001	ROCKWELL COLLINS	POWER SUPPLY TEST SET
CPL-920D	ASI-207-6	TE2	989-2159-001	ROCKWELL COLLINS	HFDL MIMS DISCRIMINATOR TEST FIXTURE
CPL-920D	ASI-207-7	TE3	989-2167-001	ROCKWELL COLLINS	RF NETWORK TEST FIXTURE
CPL-920D	ASI-207-8	TE4	989-2168-001	ROCKWELL COLLINS	RF NETWORK HOLDING FIXTURE
CPL-920D	ASI-207-9	TE5	989-2169-001	ROCKWELL COLLINS	RF NETWORK CALIBRATION FIXTURE
CPL-920D	ASI-700-4	NMN	NPN	ROCKWELL COLLINS	HF/VHF DISCRETE FUNCTION INTERFACE UNIT
CPL-920D	ASI-70-04C	NMN	NPN	ROCKWELL COLLINS	ARINC 753 HFDL INTERFACE FIXTURE
CPU-4/4A	ASI-499-5	476E-1	522-1431-004	ROCKWELL COLLINS	FLIGHT DIRECTOR TEST SET
CPU-4/4A	ASI-499-6	476E-1A	522-2848-004	ROCKWELL COLLINS	FLIGHT DIRECTOR TEST SET
CTL-20	ASI-200-21	NMN	NPN	ROCKWELL COLLINS	ASI-2000 PLUG-IN ADAPTER
CTL-20	ASI-289-1	CTS-231	622-5188-001	ROCKWELL COLLINS	OUTPUT MONITOR TEST PANEL
CTL-20	ASI-289-2	CTS-232	622-5189-001	ROCKWELL COLLINS	MONITOR / NCS SIMULATOR TEST PANEL
CTL-200	ASI-338-5	CTS-204	622-5403-001	ROCKWELL COLLINS	HF CONTROL TEST PANEL
CTL-201	ASI-338-5	CTS-204	622-5403-001	ROCKWELL COLLINS	HF CONTROL TEST PANEL
CTL-21	ASI-200-21	NMN	NPN	ROCKWELL COLLINS	ASI-2000 PLUG-IN ADAPTER
CTL-21	ASI-289-1	CTS-231	622-5188-001	ROCKWELL COLLINS	OUTPUT MONITOR TEST PANEL
CTL-21	ASI-289-2	CTS-232	622-5189-001	ROCKWELL COLLINS	MONITOR / NCS SIMULATOR TEST PANEL
CTL-22	ASI-126	NMN	NPN	ROCKWELL COLLINS	CTL-X2/X2A/23 TEST PANEL
CTL-22	ASI-200-1	NMN	NPN	ROCKWELL COLLINS	ASI-2000 PLUG-IN ADAPTER
CTL-220	ASI-338-5	CTS-204	622-5403-001	ROCKWELL COLLINS	HF CONTROL TEST PANEL
CTL-23	ASI-126	NMN	NPN	ROCKWELL COLLINS	CTL-X2/X2A/23 TEST PANEL
CTL-23	ASI-200-1	NMN	NPN	ROCKWELL COLLINS	ASI-2000 PLUG-IN ADAPTER
CTL-230	ASI-131	NMN	NPN	ROCKWELL COLLINS	PRO LINE HF CONTROL HEAD TEST PANEL
CTL-230	ASI-200-6	NMN	NPN	ROCKWELL COLLINS	ASI-2000 PLUG-IN ADAPTER
CTL-30	ASI-200-21	NMN	NPN	ROCKWELL COLLINS	ASI-2000 PLUG-IN ADAPTER
CTL-30	ASI-289-1	CTS-231	622-5188-001	ROCKWELL COLLINS	OUTPUT MONITOR TEST PANEL
CTL-30	ASI-289-2	CTS-232	622-5189-001	ROCKWELL COLLINS	MONITOR / NCS SIMULATOR TEST PANEL

ASI TEST EQUIPMENT UNIT UNDER TEST (UUT) CROSS REFERENCE

UNIT TESTED	ASI MN	EQUIV MN	EQUIV PN	EQUIV OEM	DESCRIPTION
CTL-30R	ASI-289-1	CTS-231	622-5188-001	ROCKWELL COLLINS	OUTPUT MONITOR TEST PANEL
CTL-30R	ASI-289-2	CTS-232	622-5189-001	ROCKWELL COLLINS	MONITOR / NCS SIMULATOR TEST PANEL
CTL-31	ASI-200-21	NMN	NPN	ROCKWELL COLLINS	ASI-2000 PLUG-IN ADAPTER
CTL-31	ASI-289-1	CTS-231	622-5188-001	ROCKWELL COLLINS	OUTPUT MONITOR TEST PANEL
CTL-31	ASI-289-2	CTS-232	622-5189-001	ROCKWELL COLLINS	MONITOR / NCS SIMULATOR TEST PANEL
CTL-32	ASI-126	NMN	NPN	ROCKWELL COLLINS	CTL-X2/X2A/23 TEST PANEL
CTL-32	ASI-200-1	NMN	NPN	ROCKWELL COLLINS	ASI-2000 PLUG-IN ADAPTER
CTL-60	ASI-200-21	NMN	NPN	ROCKWELL COLLINS	ASI-2000 PLUG-IN ADAPTER
CTL-60	ASI-289-1	CTS-231	622-5188-001	ROCKWELL COLLINS	OUTPUT MONITOR TEST PANEL
CTL-60	ASI-289-2	CTS-232	622-5189-001	ROCKWELL COLLINS	MONITOR / NCS SIMULATOR TEST PANEL
CTL-61	ASI-200-21	NMN	NPN	ROCKWELL COLLINS	ASI-2000 PLUG-IN ADAPTER
CTL-61	ASI-289-1	CTS-231	622-5188-001	ROCKWELL COLLINS	OUTPUT MONITOR TEST PANEL
CTL-61	ASI-289-2	CTS-232	622-5189-001	ROCKWELL COLLINS	MONITOR / NCS SIMULATOR TEST PANEL
CTL-62	ASI-126	NMN	NPN	ROCKWELL COLLINS	CTL-X2/X2A/23 TEST PANEL
CTL-62	ASI-200-1	NMN	NPN	ROCKWELL COLLINS	ASI-2000 PLUG-IN ADAPTER
CTL-90	ASI-200-21	NMN	NPN	ROCKWELL COLLINS	ASI-2000 PLUG-IN ADAPTER
CTL-90	ASI-289-1	CTS-231	622-5188-001	ROCKWELL COLLINS	OUTPUT MONITOR TEST PANEL
CTL-90	ASI-289-2	CTS-232	622-5189-001	ROCKWELL COLLINS	MONITOR / NCS SIMULATOR TEST PANEL
CTL-91	ASI-200-21	NMN	NPN	ROCKWELL COLLINS	ASI-2000 PLUG-IN ADAPTER
CTL-91	ASI-289-1	CTS-231	622-5188-001	ROCKWELL COLLINS	OUTPUT MONITOR TEST PANEL
CTL-91	ASI-289-2	CTS-232	622-5189-001	ROCKWELL COLLINS	MONITOR / NCS SIMULATOR TEST PANEL
CTL-92	ASI-126	NMN	NPN	ROCKWELL COLLINS	CTL-X2/X2A/23 TEST PANEL
CTL-92	ASI-200-1	NMN	NPN	ROCKWELL COLLINS	ASI-2000 PLUG-IN ADAPTER
CTL-92T	ASI-200-27	NMN	NPN	ROCKWELL COLLINS	ASI-2000 PLUG-IN ADAPTER
CTL-92T	ASI-220	NMN	NPN	ROCKWELL COLLINS	CTL-92T TEST PANEL
CTL-X2/X2A	ASI-126	NMN	NPN	ROCKWELL COLLINS	CTL-X2/X2A/23 TEST PANEL
CU-1094	ASI-346-3	878L-3	522-3272-000	ROCKWELL COLLINS	DISCRIMINATOR TEST PANEL
CU-1239	ASI-346-3	878L-3	522-3272-000	ROCKWELL COLLINS	DISCRIMINATOR TEST PANEL
CU-1658/A	ASI-329-1	172H-8	522-4514-001	ROCKWELL COLLINS	ELECTRICAL DUMMY LOAD
CU-1658/A	ASI-329-1A	172H-8	522-4514-002	ROCKWELL COLLINS	ELECTRICAL DUMMY LOAD
CU-1658/A	ASI-329-1B	DA-487/U	522-4514-001	ROCKWELL COLLINS	ELECTRICAL DUMMY LOAD
CU-2041/AR	ASI-329-1C	172H-8A	642-2190-001	ROCKWELL COLLINS	ELECTRICAL DUMMY LOAD
CU-2275(V)	ASI-323-21	966D-5A	622-7574-002	ROCKWELL COLLINS	RADIO SET TEST PANEL
CU-2275(V)	ASI-323-3	966D-5B	622-9034-001	ROCKWELL COLLINS	RADIO SET TEST PANEL
CU-2275(V)1	ASI-329-4	DA-174/GRM-10	522-1248-004	ROCKWELL COLLINS	ELECTRICAL DUMMY LOAD
CU-2275(V)1	ASI-329-6	DA-173/GRM-10	522-1247-002	ROCKWELL COLLINS	ELECTRICAL DUMMY LOAD
CU-2275(V)2	ASI-329-5	DA-175/GRM	522-1249-004	ROCKWELL COLLINS	ELECTRICAL DUMMY LOAD
CU-2275(V)3	ASI-329-14	172H-27	4S61700-101B	ROCKWELL COLLINS	ANTENNA SIMULATOR
CU-2314(V)	ASI-323-21	966D-5A	622-7574-002	ROCKWELL COLLINS	RADIO SET TEST PANEL
CU-2314(V)	ASI-323-3	966D-5B	622-9034-001	ROCKWELL COLLINS	RADIO SET TEST PANEL
CU-2314(V)1/2/3/4	ASI-329-3	172H-18A	622-7148-001	ROCKWELL COLLINS	SHUNT DUMMY ANTENNA
CU-2575	ASI-329-4	DA-174/GRM-10	522-1248-004	ROCKWELL COLLINS	ELECTRICAL DUMMY LOAD
CU-2575	ASI-329-6	DA-173/GRM-10	522-1247-002	ROCKWELL COLLINS	ELECTRICAL DUMMY LOAD
CU-523	ASI-346-3	878L-3	522-3272-000	ROCKWELL COLLINS	DISCRIMINATOR TEST PANEL
CVC-151	ASI-810-2	92CN-1	01-0217-00	HONEYWELL (BENDIX)	SERIES III / FLITELINE COM/NAV SYSTEM TEST PANEL
CVC-152	ASI-810-2	92CN-1	01-0217-00	HONEYWELL (BENDIX)	SERIES III / FLITELINE COM/NAV SYSTEM TEST PANEL
CVN-251	ASI-810-2	92CN-1	01-0217-00	HONEYWELL (BENDIX)	SERIES III / FLITELINE COM/NAV SYSTEM TEST PANEL
CVN-252	ASI-810-2	92CN-1	01-0217-00	HONEYWELL (BENDIX)	SERIES III / FLITELINE COM/NAV SYSTEM TEST PANEL
CWC-80	ASI-CTS-10	CTS-10	622-4561-00	ROCKWELL COLLINS	UNIVERSAL ATR BREAKOUT BOX
DA-1203A	ASI-360	NMN	NPN	HONEYWELL (BENDIX)	RDR RADAR SYSTEM TEST PANEL
DA-1502A	ASI-426	RCT-1500A	3614129-1501	HONEYWELL (BENDIX)	RADAR SYSTEM TEST PANEL
DA-1503A	ASI-426	RCT-1500A	3614129-1501	HONEYWELL (BENDIX)	RADAR SYSTEM TEST PANEL
DAA-4A	ASI-742	RCT-4A	2041589-0401	HONEYWELL (BENDIX)	RADAR SYSTEM TEST PANEL
DAA-4A	ASI-771	ATT-4A	2041592-0401	HONEYWELL (BENDIX)	RADAR ANTENNA TEST PANEL
DAA-4B	ASI-771	ATT-4A	2041592-0401	HONEYWELL (BENDIX)	RADAR ANTENNA TEST PANEL
DCP-270	ASI-188-1	NMN	NPN	ROCKWELL COLLINS	WXR DIGITAL WEATHER RADAR TEST PANEL
DCP-300	ASI-188-1	NMN	NPN	ROCKWELL COLLINS	WXR DIGITAL WEATHER RADAR TEST PANEL
DCP-320	ASI-188-1	NMN	NPN	ROCKWELL COLLINS	WXR DIGITAL WEATHER RADAR TEST PANEL
DCP-325	ASI-188-1	NMN	NPN	ROCKWELL COLLINS	WXR DIGITAL WEATHER RADAR TEST PANEL
DCP-85	ASI-396	NMN	NPN	ROCKWELL COLLINS	TEST SET
DDA-42	ASI-122	NMN	NPN	ROCKWELL COLLINS	DDA-42 TEST PANEL
DDA-42	ASI-200-15	NMN	NPN	ROCKWELL COLLINS	ASI-2000 PLUG-IN ADAPTER
DDA-4A/4B	ASI-771	ATT-4A	2041592-0401	HONEYWELL (BENDIX)	RADAR ANTENNA TEST PANEL
DDI-713	ASI-700-1	NMN	NPN	ROCKWELL COLLINS	DFIU TEST SET
DF-202G	ASI-192	477U-2	522-2710-000	ROCKWELL COLLINS	ADF ANTENNA SIMULATOR
DF-203	ASI-192	477U-2	522-2710-000	ROCKWELL COLLINS	ADF ANTENNA SIMULATOR
DF-203	ASI-193	477V-2	522-2711-002	ROCKWELL COLLINS	ADF TEST SET
DF-203	ASI-201-2	477U-3	522-4458-002	ROCKWELL COLLINS	ADF TEST SET
DF-206	ASI-184	477V-3	792-6209-001	ROCKWELL COLLINS	FAULT ISOLATION PANEL
DF-206	ASI-192	477U-2	522-2710-000	ROCKWELL COLLINS	ADF ANTENNA SIMULATOR
DF-206	ASI-193	477V-2	522-2711-002	ROCKWELL COLLINS	ADF TEST SET
DF-206A	ASI-375-1	970G-2	622-7345-001	ROCKWELL COLLINS	ADF TEST PANEL
DF-206A	ASI-61W	970W-1	622-3099-001	ROCKWELL COLLINS	ADF ANTENNA SIMULATOR
DF-301E	ASI-790	970V-1	622-3029-001	ROCKWELL COLLINS	DIRECTION FINDER TEST SET
DF-431A	ASI-810-1	92AF-1	01-0216-00	HONEYWELL (BENDIX)	SERIES III / FLITELINE ADF SYSTEM TEST PANEL

ASI TEST EQUIPMENT UNIT UNDER TEST (UUT) CROSS REFERENCE

UNIT TESTED	ASI MN	EQUIV MN	EQUIV PN	EQUIV OEM	DESCRIPTION
DF-431B	ASI-810-1	92AF-1	01-0216-00	HONEYWELL (BENDIX)	SERIES III / FLITELINE ADF SYSTEM TEST PANEL
DFA-206A	ASI-375-1	970G-2	622-7345-001	ROCKWELL COLLINS	ADF TEST PANEL
DFA-73A	ASI-202-1	DFT-73AA	2064943-0501	HONEYWELL (BENDIX)	ADF SYSTEM TEST PANEL
DFA-73A1	ASI-202-1	DFT-73AA	2064943-0501	HONEYWELL (BENDIX)	ADF SYSTEM TEST PANEL
DFA-73AA	ASI-202-1	DFT-73AA	2064943-0501	HONEYWELL (BENDIX)	ADF SYSTEM TEST PANEL
DFA-73AC	ASI-202-2	DFT-73C1	2070555-0501	HONEYWELL (BENDIX)	ASF SYSTEM TEST PANEL
DFA-73AF	ASI-202-2	DFT-73C1	2070555-0501	HONEYWELL (BENDIX)	ASF SYSTEM TEST PANEL
DFA-74A	ASI-202-1	DFT-73AA	2064943-0501	HONEYWELL (BENDIX)	ADF SYSTEM TEST PANEL
DFA-75A	ASI-700-2	NMN	NPN	HONEYWELL (BENDIX)	ADF/ILS/MB/VOR DFIU
DFA-75A	ASI-804	DFT-75A	2041520-7501	HONEYWELL (BENDIX)	ADF TEST PANEL
DFC-206A	ASI-375-1	970G-2	622-7345-001	ROCKWELL COLLINS	ADF TEST PANEL
DFR-206A	ASI-375-1	970G-2	622-7345-001	ROCKWELL COLLINS	ADF TEST PANEL
DFS-43A	ASI-810-1	92AF-1	01-0216-00	HONEYWELL (BENDIX)	DFS-43A SYSTEM TEST PANEL
DG-304	ASI-410	T307967	NPN	HONEYWELL (SPERRY)	FLUX VALVE HEADING SIMULATOR
DG-401	ASI-275-1	T307976	NPN	HONEYWELL (SPERRY)	C14 PRELIMINARY AND FINAL TEST PANEL
DG-401	ASI-275-2	T307977	NPN	HONEYWELL (SPERRY)	DG-401 CALIBRATION FIXTURE
DG-401	ASI-407-1	T307702-4	NPN	HONEYWELL (SPERRY)	POWER SUPPLY AND READOUT FIXTURE
DGS-65	ASI-412	CTS-64	622-6459-001	ROCKWELL COLLINS	MCS-65 COMPASS SYSTEM TEST PANEL
DGS-65	ASI-412-2	NMN	NPN	ROCKWELL COLLINS	DGS-65 CUSTOMER ACCEPTANCE TEST SET
DI-1007	ASI-155	NMN	7010569-901	HONEYWELL (SPERRY)	UNIVERSAL DIGITAL INTERFACE TEST CIRCUIT
DI-1008	ASI-155	NMN	7010569-901	HONEYWELL (SPERRY)	UNIVERSAL DIGITAL INTERFACE TEST CIRCUIT
DI-2006	ASI-155	NMN	7010569-901	HONEYWELL (SPERRY)	UNIVERSAL DIGITAL INTERFACE TEST CIRCUIT
DI-2007	ASI-155	NMN	7010569-901	HONEYWELL (SPERRY)	UNIVERSAL DIGITAL INTERFACE TEST CIRCUIT
DI-2008	ASI-155	NMN	7010569-901	HONEYWELL (SPERRY)	UNIVERSAL DIGITAL INTERFACE TEST CIRCUIT
DI-3001	ASI-155	NMN	7010569-901	HONEYWELL (SPERRY)	UNIVERSAL DIGITAL INTERFACE TEST CIRCUIT
DI-4001	ASI-155	NMN	7010569-901	HONEYWELL (SPERRY)	UNIVERSAL DIGITAL INTERFACE TEST CIRCUIT
DI-4002	ASI-155	NMN	7010569-901	HONEYWELL (SPERRY)	UNIVERSAL DIGITAL INTERFACE TEST CIRCUIT
DI-5001	ASI-155	NMN	7010569-901	HONEYWELL (SPERRY)	UNIVERSAL DIGITAL INTERFACE TEST CIRCUIT
DI-9001	ASI-155	NMN	7010569-901	HONEYWELL (SPERRY)	UNIVERSAL DIGITAL INTERFACE TEST CIRCUIT
DI-9002	ASI-155	NMN	7010569-901	HONEYWELL (SPERRY)	UNIVERSAL DIGITAL INTERFACE TEST CIRCUIT
DI-9004	ASI-155	NMN	7010569-901	HONEYWELL (SPERRY)	UNIVERSAL DIGITAL INTERFACE TEST CIRCUIT
DLC-800	ASI-0182-DLC	NMN	827-0182-001	ROCKWELL COLLINS	POWER SUPPLY TEST FIXTURE
DLC-800	ASI-0465-DLC	NMN	827-0465-003	ROCKWELL COLLINS	DLC-800 TEST PANEL
DLC-800	ASI-1934-DLC	NMN	647-1934-000	ROCKWELL COLLINS	BACKLIGHT TEST FIXTURE
DLC-800	ASI-8260-DLC	NMN	646-8260-001	ROCKWELL COLLINS	EXTENDER CABLE, A3
DLC-800	ASI-8261-DLC	NMN	646-8260-002	ROCKWELL COLLINS	EXTENDER CABLE, A4, A5, A6
DLM-700()	ASI-0201-DLM	NMN	827-0201-002	ROCKWELL COLLINS	BREAKOUT TO MU CABLE
DLM-700()	ASI-0202-DLM	NMN	827-0201-004	ROCKWELL COLLINS	BREAKOUT TO LOOPBACK PANEL
DLM-700()	ASI-1100-DLM	NMN	827-1100-002	ROCKWELL COLLINS	BREAKOUT PANEL
DLM-700()	ASI-1130-DLM	NMN	827-1130-001	ROCKWELL COLLINS	POWER DISTRIBUTION PANEL
DLM-700()	ASI-1522-DLM	NMN	827-1522-009	ROCKWELL COLLINS	ACARS LOOPBACK POD
DLM-700()	ASI-3842-DLM	NMN	676-3842-001	ROCKWELL COLLINS	DLM PWR SUPPLY (676-7059-002) TEST SET
DLM-700()	ASI-7779-DLM(L)	NMN	649-7779-001	ROCKWELL COLLINS	CIRCUIT CARD EXTENDER, LEFT
DLM-700()	ASI-7779-DLM(R)	NMN	649-7779-0023	ROCKWELL COLLINS	CIRCUIT CARD EXTENDER, RIGHT
DLM-700()	ASI-8803-DLM	NMN	659-8803-003	ROCKWELL COLLINS	DATA LINK TEST ADAPTER
DLM-700()	ASI-9557-DLM	NMN	NPN	ROCKWELL COLLINS	POWER SUPPLY A6 TEST FIXTURE
DLM-900	ASI-745-1	NMN	830-3834-001	ROCKWELL COLLINS	POWER SUPPLY TEST SET
DLM-900	ASI-746-1	NMN	676-7387-003	ROCKWELL COLLINS	RAM BUFFER CARD
DLM-900	ASI-747	NMN	676-7385-001	ROCKWELL COLLINS	BUS BUFFER CARD
DLM-900	ASI-748	NMN	830-4928-001	ROCKWELL COLLINS	LOOPBACK POD
DM-441A	ASI-810-2	92XD-1	01-0218-00	HONEYWELL (BENDIX/KING)	SERIES III / FLITELINE DME/XPDR SYSTEM TEST PANEL
DM-441B	ASI-810-2	92XD-1	01-0218-00	HONEYWELL (BENDIX/KING)	SERIES III / FLITELINE DME/XPDR SYSTEM TEST PANEL
DMA-37A	ASI-801	DMT-37A	2041594-3701	HONEYWELL (BENDIX/KING)	DME TEST PANEL
DME-40	ASI-182	975D-2	622-3582-001	ROCKWELL COLLINS	DME TEST SET
DME-40	ASI-200-5	NMN	NPN	ROCKWELL COLLINS	ASI-2000 PLUG-IN ADAPTER
DME-40	ASI-283	NMN	NPN	ROCKWELL COLLINS	TROUBLESHOOTING PROBE
DME-40	ASI-292	968W-1	622-4725-001	ROCKWELL COLLINS	DME-40 TEST PANEL
DME-40	ASI-416	NMN	NPN	ROCKWELL COLLINS	DME TEST SET
DME-40	ASI-CTS-10	CTS-10	622-4561-00	ROCKWELL COLLINS	UNIVERSAL ATR BREAKOUT BOX
DME-40A	ASI-120	NMN	NPN	ROCKWELL COLLINS	TCN-40 SYSTEM TEST PANEL
DME-40A	ASI-200-5	NMN	NPN	ROCKWELL COLLINS	ASI-2000 PLUG-IN ADAPTER (WITH SB19-5)
DME-42	ASI-134	NMN	NPN	ROCKWELL COLLINS	PRO LINE DME TEST PANEL
DME-42	ASI-200-5	NMN	NPN	ROCKWELL COLLINS	ASI-2000 PLUG-IN ADAPTER
DME-42	ASI-200-5A-1	NMN		ROCKWELL COLLINS	DME SIMULATOR CARD
DME-42	ASI-CTS-10	CTS-10	622-4561-00	ROCKWELL COLLINS	UNIVERSAL ATR BREAKOUT BOX
DME-442	ASI-134	NMN	NPN	ROCKWELL COLLINS	PRO LINE DME TEST PANEL
DME-442	ASI-200-13	NMN	NPN	ROCKWELL COLLINS	ASI-2000 PLUG-IN ADAPTER
DME-442	ASI-200-5A-1	NMN	NPN	ROCKWELL COLLINS	DME SIMULATOR CARD
DME-442	ASI-CTS-10	CTS-10	622-4561-00	ROCKWELL COLLINS	UNIVERSAL ATR BREAKOUT BOX
DME-450	ASI-257	CTS-451	622-3882-001	ROCKWELL COLLINS	DME-451 TEST SET
DME-450C	ASI-257	CTS-451	622-3882-001	ROCKWELL COLLINS	DME-451 TEST SET
DME-451	ASI-257	CTS-451	622-3882-001	ROCKWELL COLLINS	DME-451 TEST SET
DME-700	ASI-700-3	NMN	NPN	ROCKWELL COLLINS	DME/LRA DISCRETE FUNCTION INTERFACE PANEL
DME-700	ASI-706	MST-904	622-6103-001	ROCKWELL COLLINS	MICROPROCESSOR TEST ADAPTER
DME-700	ASI-707	NMN	NPN	ROCKWELL COLLINS	DRIVER A4 ALIGNMENT COVER

ASI TEST EQUIPMENT UNIT UNDER TEST (UUT) CROSS REFERENCE

UNIT TESTED	ASI MN	EQUIV MN	EQUIV PN	EQUIV OEM	DESCRIPTION
DME-900	ASI-700-3	NMN	NPN	ROCKWELL COLLINS	DME/LRA DISCRETE FUNCTION INTERFACE PANEL
DMS-44A	ASI-810-2	92XD-1	01-0218-00	HONEYWELL (BENDIX/KING)	DMS-44A/TRS-44A SYSTEM TEST PANEL
DPU-85	ASI-CTS-9	CTS-9	622-6720-001	ROCKWELL COLLINS	UNIVERSAL ATR BREAKOUT BOX
DPU-86	ASI-CTS-9	CTS-9	622-6720-001	ROCKWELL COLLINS	UNIVERSAL ATR BREAKOUT BOX
DRI-55	ASI-218	NMN	NPN	ROCKWELL COLLINS	INDICATOR TEST PANEL
DRI-55	ASI-299	NMN	828-8249-001	ROCKWELL COLLINS	ALT TEST PANEL
DSA-220	ASI-211	NMN	NPN	ROCKWELL COLLINS	DUAL SYSTEM/LONG WIRE ADAPTER TEST SET
DSP-7000	ASI-744	NMN	NPN	ROCKWELL COLLINS	DSP-7000 STANDARD TEST PANEL
DU-1000	ASI-701	NMN	652-9764-001	ROCKWELL COLLINS	HI-VOLT PWR SUPPLY TEST SET
EAP-701	ASI-705	NMN	NPN	ROCKWELL COLLINS	POWER SUPPLY TEST FIXTURE
EDU-766/776	ASI-701	NMN	652-9764-001	ROCKWELL COLLINS	HI-VOLT PWR SUPPLY TEST SET
EDU-766/776	ASI-740	NMN	647-8028-001	ROCKWELL COLLINS	LO-VOLT POWER SUPPLY TEST SET
EDU-870	ASI-701	NMN	652-9764-001	ROCKWELL COLLINS	HI-VOLT PWR SUPPLY TEST SET
EFD-84	ASI-417-1	CTS-855	622-6457-011	ROCKWELL COLLINS	ELECTRONICS FLIGHT DISPLAY SYSTEM TEST PANEL
EFD-84	ASI-418	CTS-858	622-7321-001	ROCKWELL COLLINS	EFD/MFD GAIN POSITION CALIBRATOR
EFD-85	ASI-417-1	CTS-855	622-6457-011	ROCKWELL COLLINS	ELECTRONICS FLIGHT DISPLAY SYSTEM TEST PANEL
EFD-85	ASI-418	CTS-858	622-7321-001	ROCKWELL COLLINS	EFD/MFD GAIN POSITION CALIBRATOR
EFD-86	ASI-417-1	CTS-855	622-6457-011	ROCKWELL COLLINS	ELECTRONICS FLIGHT DISPLAY SYSTEM TEST PANEL
EFD-86	ASI-418	CTS-858	622-7321-001	ROCKWELL COLLINS	EFD/MFD GAIN POSITION CALIBRATOR
EFIS-84/85/86	ASI-417-1	CTS-855	622-6457-011	ROCKWELL COLLINS	ELECTRONICS FLIGHT DISPLAY SYSTEM TEST PANEL
EFIS-84/85/86	ASI-418	CTS-858	622-7321-001	ROCKWELL COLLINS	EFD/MFD GAIN POSITION CALIBRATOR
F-1420	ASI-308-2	AN/ARM-165A	622-2750-001	ROCKWELL COLLINS	RADIO TEST SET
FCC-85	ASI-388	NMN	NPN	ROCKWELL COLLINS	TEST AID FIXTURE
FCC-85	ASI-389	NMN	NPN	ROCKWELL COLLINS	SERVO PANEL
FCC-85	ASI-CTS-9	CTS-9	622-6720-001	ROCKWELL COLLINS	UNIVERSAL ATR BREAKOUT BOX
FCC-86	ASI-388	NMN	NPN	ROCKWELL COLLINS	TEST AID FIXTURE
FCC-86	ASI-389	NMN	NPN	ROCKWELL COLLINS	SERVO PANEL
FCC-86	ASI-CTS-9	CTS-9	622-6720-001	ROCKWELL COLLINS	UNIVERSAL ATR BREAKOUT BOX
FCS-105	ASI-183	971F-1	622-2013-002	ROCKWELL COLLINS	FCS-105 AUTOPILOT TEST SET
FCS-105	ASI-286	CTS-82	622-4562-001	ROCKWELL COLLINS	AUTOPILOT TEST SET
FCS-80	ASI-286	CTS-82	622-4562-001	ROCKWELL COLLINS	AUTOPILOT TEST SET
FD-108	ASI-377-1	978F-4A	522-3427-001	ROCKWELL COLLINS	AMPLIFIER TEST PANEL FOR FD-108/109
FD-109	ASI-377-1	978F-4A	522-3427-001	ROCKWELL COLLINS	AMPLIFIER TEST PANEL FOR FD-108/109
FD-109	ASI-377-2	978F-9A	522-4085-001	ROCKWELL COLLINS	AMPLIFIER TEST ADAPTER PANEL FOR FD-109
FD-112A	ASI-343	NMN	NPN	ROCKWELL COLLINS	FD-112 TEST PANEL
FD-112A/B/C/V	ASI-166	479X-2	522-0167-001	ROCKWELL COLLINS	RESOLVER ZEROING PANEL
FD-112A/B/C/V	ASI-167	978F-2S	522-3498-000	ROCKWELL COLLINS	SYNCHRO SIMULATOR
FD-112A/B/C/V	ASI-343	NMN	NPN	ROCKWELL COLLINS	FD-112 TEST PANEL
FDU-70	ASI-412	CTS-64	622-6459-001	ROCKWELL COLLINS	MCS-65 COMPASS SYSTEM TEST PANEL
FGC-65	ASI-CTS-10	CTS-10	622-4561-00	ROCKWELL COLLINS	UNIVERSAL ATR BREAKOUT BOX
FGC-80	ASI-286	CTS-82	622-4562-001	ROCKWELL COLLINS	AUTOPILOT TEST SET
FGC-80	ASI-CTS-10	CTS-10	622-4561-00	ROCKWELL COLLINS	UNIVERSAL ATR BREAKOUT BOX
FGC-80()	ASI-40Y-67A	440Y-67A	622-4086-001	ROCKWELL COLLINS	980L-1 PLUG-IN ADAPTER
FGP-80()	ASI-40Y-67A	440Y-67A	622-4086-001	ROCKWELL COLLINS	980L-1 PLUG-IN ADAPTER
FGP-81()	ASI-40Y-67A	440Y-67A	622-4086-001	ROCKWELL COLLINS	980L-1 PLUG-IN ADAPTER
FMC-28/28A	ASI-166	479X-2	522-0167-001	ROCKWELL COLLINS	RESOLVER ZEROING PANEL
FMC-28/28A	ASI-167	978F-2S	522-3498-000	ROCKWELL COLLINS	SYNCHRO SIMULATOR
FMC-28/28A	ASI-288	968A-1	622-3962-001	ROCKWELL COLLINS	FLIGHT MODE CONTROL TEST PANEL
FPA-80	ASI-281	NMN	NPN	ROCKWELL COLLINS	FPA-80 TEST PANEL
FPA-80	ASI-CTS-10	CTS-10	622-4561-00	ROCKWELL COLLINS	UNIVERSAL ATR BREAKOUT BOX
FPC-75	ASI-295	969T-1	622-3868-001	ROCKWELL COLLINS	GPWS TEST SET
FPC-75	ASI-296-1	971T-1	622-2640-001	ROCKWELL COLLINS	FLIGHT PROFILE COMPARATOR TEST PANEL
GLU-910	ASI-700-2	NMN	NPN	ROCKWELL COLLINS	ADF/GLU/LLS/VOR D.F.I.U
GPW-83	ASI-422	CPT-83A	2041065-8301	ROCKWELL COLLINS	GPW SYSTEM TEST PANEL
HCP-74/74C	ASI-334	NMN	NPN	ROCKWELL COLLINS	TEST SET
HF-200/220/230	ASI-338-1	CTS-200	622-4281-001	ROCKWELL COLLINS	INTERCONNECT TEST AET
HF-200/220/230	ASI-338-2	CTS-201	622-4282-001	ROCKWELL COLLINS	HF ANTENNA SIMULATOR
HF-200/220/230	ASI-338-3	CTS-202	622-4283-001	ROCKWELL COLLINS	HF TRANSCIVER PA TEST PANEL
HF-200/220/230	ASI-338-4	CTS-203	622-4285-001	ROCKWELL COLLINS	HF COUPLER LOGIC TEST PANEL
HF-200/220/230	ASI-338-5	CTS-204	622-5403-001	ROCKWELL COLLINS	HF CONTROL TEST PANEL
HF-200/220/230	ASI-338-6	PFP-200	622-3839-001	ROCKWELL COLLINS	HF PROM FREQUENCY PROGRAMMER
HF-200/220/230	ASI-Y-1	NMN	634-9848-001	ROCKWELL COLLINS	HF Y-ADAPTER UNIT
HF-9000	ASI-777	TE-9210	822-1429-001	ROCKWELL COLLINS	HF-9000 SYSTEM TEST PANEL
HF-9000	ASI-778	TE-9400	622-9420-001	ROCKWELL COLLINS	HF-9000 EXTENDER KIT
HF-9010	ASI-777	TE-9210	822-1429-001	ROCKWELL COLLINS	HF-9000 SYSTEM TEST PANEL
HF-9012	ASI-777	TE-9210	822-1429-001	ROCKWELL COLLINS	HF-9000 SYSTEM TEST PANEL
HF-9012D	ASI-777	TE-9210	822-1429-001	ROCKWELL COLLINS	HF-9000 SYSTEM TEST PANEL
HF-9030	ASI-777	TE-9210	822-1429-001	ROCKWELL COLLINS	HF-9000 SYSTEM TEST PANEL
HF-9031	ASI-777	TE-9210	822-1429-001	ROCKWELL COLLINS	HF-9000 SYSTEM TEST PANEL
HF-9032	ASI-777	TE-9210	822-1429-001	ROCKWELL COLLINS	HF-9000 SYSTEM TEST PANEL
HF-9034	ASI-777	TE-9210	822-1429-001	ROCKWELL COLLINS	HF-9000 SYSTEM TEST PANEL
HF-9034	ASI-777	TE-9210	822-1429-001	ROCKWELL COLLINS	HF-9000 SYSTEM TEST PANEL
HF-9040	ASI-207-1	172H-18	622-0180-001	ROCKWELL COLLINS	DUMMY ANTENNA SHUNT
HF-9040	ASI-329-3	172H-18A	622-7148-001	ROCKWELL COLLINS	SHUNT DUMMY ANTENNA
HF-9040	ASI-777	TE-9210	822-1429-001	ROCKWELL COLLINS	HF-9000 SYSTEM TEST PANEL

ASI TEST EQUIPMENT UNIT UNDER TEST (UUT) CROSS REFERENCE

UNIT TESTED	ASI MN	EQUIV MN	EQUIV PN	EQUIV OEM	DESCRIPTION
HF-9041	ASI-207-1	172H-18	622-0180-001	ROCKWELL COLLINS	DUMMY ANTENNA SHUNT
HF-9041	ASI-329-3	172H-18A	622-7148-001	ROCKWELL COLLINS	SHUNT DUMMY ANTENNA
HF-9041	ASI-777	TE-9210	822-1429-001	ROCKWELL COLLINS	HF-9000 SYSTEM TEST PANEL
HF-9042	ASI-207-1	172H-18	622-0180-001	ROCKWELL COLLINS	DUMMY ANTENNA SHUNT
HF-9042	ASI-329-3	172H-18A	622-7148-001	ROCKWELL COLLINS	SHUNT DUMMY ANTENNA
HF-9042	ASI-329-8	172H-21A	622-1732-001	ROCKWELL COLLINS	ANTENNA SIMULATOR
HF-9042	ASI-329-8A	172H-21A	622-1732-002	ROCKWELL COLLINS	ANTENNA SIMULATOR
HF-9042	ASI-777	TE-9210	822-1429-001	ROCKWELL COLLINS	HF-9000 SYSTEM TEST PANEL
HF-9070	ASI-777	TE-9210	822-1429-001	ROCKWELL COLLINS	HF-9000 SYSTEM TEST PANEL
HF-9072	ASI-777	TE-9210	822-1429-001	ROCKWELL COLLINS	HF-9000 SYSTEM TEST PANEL
HF-9087D	ASI-777	TE-9210	822-1429-001	ROCKWELL COLLINS	HF-9000 SYSTEM TEST PANEL
HFS-700	ASI-700-4	NMN	NPN	ROCKWELL COLLINS	HF/VHF DISCRETE FUNCTION TEST PANEL
HFS-700	ASI-711	NMN	NPN	ROCKWELL COLLINS	500 OHM ATTENUATOR
HFS-700	ASI-712	NMN	NPN	ROCKWELL COLLINS	RF INJECTION PROBE
HFS-700D	ASI-700-4	NMN	NPN	ROCKWELL COLLINS	HF/VHF DISCRETE FUNCTION TEST PANEL
HFS-700D	ASI-70-04C	NMN	NPN	ROCKWELL COLLINS	ARINC 753 HFDL INTERFACE FIXTURE
HFS-900	ASI-700-4	NMN	NPN	ROCKWELL COLLINS	HF/VHF DISCRETE FUNCTION TEST PANEL
HFS-900D	ASI-700-4	NMN	NPN	ROCKWELL COLLINS	HF/VHF DISCRETE FUNCTION TEST PANEL
HFS-900D	ASI-70-04C	NMN	NPN	ROCKWELL COLLINS	ARINC 753 HFDL INTERFACE FIXTURE
HG7501	ASI-332	UG2559AB	NPN	HONEYWELL	RADAR ALTIMETER TEST SET
HG7502	ASI-332	UG2559AB	NPN	HONEYWELL	RADAR ALTIMETER TEST SET
HG7502	ASI-333	UG2926AA	NPN	HONEYWELL	CALIBRATION FIXTURE
HG7601	ASI-332	UG2559AB	NPN	HONEYWELL	RADAR ALTIMETER TEST SET
HG7602	ASI-332	UG2559AB	NPN	HONEYWELL	RADAR ALTIMETER TEST SET
HG7605	ASI-332	UG2559AB	NPN	HONEYWELL	RADAR ALTIMETER TEST SET
HPU-74	ASI-394	NMN	NPN	ROCKWELL COLLINS	ANALOG MULTIPLEXER TEST FIXTURE
HPU-74	ASI-CTS-10	CTS-10	622-4561-00	ROCKWELL COLLINS	UNIVERSAL ATR BREAKOUT BOX
HSD-830	ASI-166	479X-2	522-0167-001	HONEYWELL (BENDIX/KING)	RESOLVER ZEROING PANEL
HSI-45	ASI-40Y-23	440Y-23	777-1042-001	ROCKWELL COLLINS	980L-1 PLUG-IN ADAPTER
HSI-45	ASI-40Y-23	440Y-23	777-1042-001	ROCKWELL COLLINS	980L-1 PLUG-IN ADAPTER
HSI-45	ASI-40Y-23AB	NMN	NPN	ROCKWELL COLLINS	HSI-45 ADAPTER FOR 440Y-23
HSI-70()	ASI-167	978F-2S	522-3498-000	ROCKWELL COLLINS	SYNCHRO SIMULATOR
HSI-70()	ASI-191	978F-1D	522-3424-000	ROCKWELL COLLINS	INSTRUMENT TEST SET
HSI-84()	ASI-167	978F-2S	522-3498-000	ROCKWELL COLLINS	SYNCHRO SIMULATOR
HSI-84()	ASI-191	978F-1D	522-3424-000	ROCKWELL COLLINS	INSTRUMENT TEST SET
HSI-85()	ASI-CTS-12	CTS-12	622-5381-001	ROCKWELL COLLINS	HSI-85 INSTRUMENT TEST SET
ID-1972	ASI-308-2	AN/ARM-165A	622-2750-001	ROCKWELL COLLINS	RADIO TEST SET
ID-1984	ASI-308-2	AN/ARM-165A	622-2750-001	ROCKWELL COLLINS	RADIO TEST SET
ID-2121A	ASI-300	973W-2	622-5058-001	ROCKWELL COLLINS	RADIO TEST SET
ID-2121A	ASI-301	973W-3	622-6121-001	ROCKWELL COLLINS	RADIO TEST SET
ID-2229A	ASI-300	973W-2	622-5058-001	ROCKWELL COLLINS	RADIO TEST SET
ID-2229A	ASI-301	973W-3	622-6121-001	ROCKWELL COLLINS	RADIO TEST SET
ID-2303	ASI-300	973W-2	622-5058-001	ROCKWELL COLLINS	RADIO TEST SET
ID-2303	ASI-301	973W-3	622-6121-001	ROCKWELL COLLINS	RADIO TEST SET
ILS-70	ASI-219	NMN	NPN	ROCKWELL COLLINS	ILS-70 TEST PANEL
ILS-700	ASI-700-2	NMN	NPN	ROCKWELL COLLINS	ADF/GLU/ILS/VOR D.F.I.U
ILS-700	ASI-713	MST-903	622-6102-001	ROCKWELL COLLINS	MICROPROCESSOR TEST ADAPTER
ILS-700	ASI-714	NMN	827-0200-003	ROCKWELL COLLINS	IDENT SIGNAL GENERATOR
ILS-700	ASI-715	NMN	NPN	ROCKWELL COLLINS	TUNING COVER
ILS-720	ASI-700-2	NMN	NPN	ROCKWELL COLLINS	ADF/GLU/ILS/VOR D.F.I.U.
ILS-900	ASI-700-2	NMN	NPN	ROCKWELL COLLINS	ADF/GLU/ILS/VOR D.F.I.U
IN-1152A/B	ASI-360	NMN	NPN	HONEYWELL (BENDIX/KING)	RDR RADAR SYSTEM TEST PANEL
IN-1202A	ASI-360	NMN	NPN	HONEYWELL (BENDIX/KING)	RDR RADAR SYSTEM TEST PANEL
IN-132A	ASI-360	NMN	NPN	HONEYWELL (BENDIX/KING)	RDR RADAR SYSTEM TEST PANEL
IN-1502A	ASI-426	RCT-1500A	3614129-1501	HONEYWELL (BENDIX/KING)	RADAR SYSTEM TEST PANEL
IN-1503A	ASI-426	RCT-1500A	3614129-1501	HONEYWELL (BENDIX/KING)	RADAR SYSTEM TEST PANEL
IN-152A	ASI-360	NMN	NPN	HONEYWELL (BENDIX/KING)	RDR RADAR SYSTEM TEST PANEL
IN-182A	ASI-783	NMN	NPN	HONEYWELL (BENDIX/KING)	RDR-2000/2100 RADAR SYSTEM TEST SET
IN-182A	ASI-786	NMN	NPN	HONEYWELL (BENDIX/KING)	RDS RADAR SYSTEM TEST SET
IN-2022A	ASI-360	NMN	NPN	HONEYWELL (BENDIX/KING)	RDR RADAR SYSTEM TEST PANEL
IN-2025A/B	ASI-360	NMN	NPN	HONEYWELL (BENDIX/KING)	RDR RADAR SYSTEM TEST PANEL
IN-2026A	ASI-360	NMN	NPN	HONEYWELL (BENDIX/KING)	RDR RADAR SYSTEM TEST PANEL
IN-2027A	ASI-360	NMN	NPN	HONEYWELL (BENDIX/KING)	RDR RADAR SYSTEM TEST PANEL
IN-812A	ASI-786	NMN	NPN	HONEYWELL (BENDIX/KING)	RDS RADAR SYSTEM TEST SET
IN-831A	ASI-166	479X-2	522-0167-001	HONEYWELL (BENDIX/KING)	RESOLVER ZEROING PANEL
IN-842A	ASI-783	NMN	NPN	HONEYWELL (BENDIX/KING)	RDR-2000/2100 RADAR SYSTEM TEST SET
IN-842A	ASI-786	NMN	NPN	HONEYWELL (BENDIX/KING)	RDS RADAR SYSTEM TEST SET
IN-862A	ASI-783	NMN	NPN	HONEYWELL (BENDIX/KING)	RDR-2000/2100 RADAR SYSTEM TEST SET
IN-862A	ASI-786	NMN	NPN	HONEYWELL (BENDIX/KING)	RDS RADAR SYSTEM TEST SET
INA-51A	ASI-164	NMN	NPN	HONEYWELL (BENDIX/KING)	RADIO ALTIMETER INDICATOR TEST PANEL
INA-51A	ASI-199	ALT-51A	2037120-0501	HONEYWELL (BENDIX)	RADIO ALTIMETER TEST PANEL
INA-51B	ASI-164	NMN	NPN	HONEYWELL (BENDIX)	RADIO ALTIMETER INDICATOR TEST PANEL
INA-51B	ASI-199	ALT-51A	2037120-0501	HONEYWELL (BENDIX)	RADIO ALTIMETER TEST PANEL
INA-51D	ASI-164	NMN	NPN	HONEYWELL (BENDIX)	RADIO ALTIMETER INDICATOR TEST PANEL
INA-51V	ASI-164	NMN	NPN	HONEYWELL (BENDIX)	RADIO ALTIMETER INDICATOR TEST PANEL

ASI TEST EQUIPMENT UNIT UNDER TEST (UUT) CROSS REFERENCE

UNIT TESTED	ASI MN	EQUIV MN	EQUIV PN	EQUIV OEM	DESCRIPTION
INA-51V	ASI-199	ALT-51A	2037120-0501	HONEYWELL (BENDIX)	RADIO ALTIMETER TEST PANEL
IND-150	ASI-188-1	NMN	NPN	ROCKWELL COLLINS	WXR DIGITAL WEATHER RADAR TEST PANEL
IND-200	ASI-188-1	NMN	NPN	ROCKWELL COLLINS	WXR DIGITAL WEATHER RADAR TEST PANEL
IND-200A	ASI-188-1	NMN	NPN	ROCKWELL COLLINS	WXR DIGITAL WEATHER RADAR TEST PANEL
IND-201	ASI-188-1	NMN	NPN	ROCKWELL COLLINS	WXR DIGITAL WEATHER RADAR TEST PANEL
IND-220	ASI-188-1	NMN	NPN	ROCKWELL COLLINS	WXR DIGITAL WEATHER RADAR TEST PANEL
IND-250A	ASI-188-1	NMN	NPN	ROCKWELL COLLINS	WXR DIGITAL WEATHER RADAR TEST PANEL
IND-250C	ASI-188-1	NMN	NPN	ROCKWELL COLLINS	WXR DIGITAL WEATHER RADAR TEST PANEL
IND-270	ASI-188-1	NMN	NPN	ROCKWELL COLLINS	WXR DIGITAL WEATHER RADAR TEST PANEL
IND-300	ASI-188-1	NMN	NPN	ROCKWELL COLLINS	WXR DIGITAL WEATHER RADAR TEST PANEL
IND-300	ASI-297	CTS-300	622-4946-001	ROCKWELL COLLINS	GENERATOR TEST PANEL
IND-40()	ASI-416	NMN	NPN	ROCKWELL COLLINS	DME TEST SET
IND-41()	ASI-416	NMN	NPN	ROCKWELL COLLINS	DME TEST SET
IND-42	ASI-200-5	NMN	NPN	ROCKWELL COLLINS	ASI-2000 PLUG-IN ADAPTER
IND-42	ASI-134	NMN	NPN	ROCKWELL COLLINS	DME-42/442 TEST PANEL;
IND-450	ASI-257	CTS-451	622-3882-001	ROCKWELL COLLINS	DME-451 TEST SET
IND-450C	ASI-257	CTS-451	622-3882-001	ROCKWELL COLLINS	DME-451 TEST SET
IND-451	ASI-257	CTS-451	622-3882-001	ROCKWELL COLLINS	DME-451 TEST SET
ITA-81A	ASI-743	AIT-4A	8074503-0401	HONEYWELL (BENDIX)	TCAS PPT ADAPTER PANEL
IU-1507A	ASI-426	RCT-1500A	3614129-1501	HONEYWELL (BENDIX/KING)	RADAR SYSTEM TEST PANEL
IUA-15B	ASI-423-1	IUT-15B	3614367-0101	HONEYWELL (BENDIX)	AIU TEST PANEL
KA-133	ASI-428-2	NMN	696-6257-00	HONEYWELL (BENDIX/KING)	KRA-10() BENCH TEST SET
KAC-1052	ASI-793-1	NMN	NPN	HONEYWELL (BENDIX/KING)	SYSTEM TEST HARNESS
KAC-952	ASI-708-1	KTS-157	071-5040-00	HONEYWELL (BENDIX/KING)	HF/SSB TEST SET (REQUIRES ASI-70-8A)
KAC-992	ASI-792	KTS-192	NPN	HONEYWELL (BENDIX/KING)	PROBE/ANTENNA COUPLER TEST SET
KAC-992	ASI-793	NMN	155-1442-00	HONEYWELL (BENDIX/KING)	SYSTEM TEST HARNESS
KAD-280	ASI-362	NMN	696-05641-0001	HONEYWELL (BENDIX/KING)	KAD-280 TEST SET
KCU-951	ASI-708-1	KTS-157	071-5040-00	HONEYWELL (BENDIX/KING)	HF/SSB TEST SET
KDC-281	ASI-362	NMN	696-05641-0001	HONEYWELL (BENDIX/KING)	KAD-280 TEST SET
KDI-572	ASI-357	NMN	NPN	HONEYWELL (BENDIX/KING)	DME/TACAN TEST PANEL
KDI-573	ASI-357	NMN	NPN	HONEYWELL (BENDIX/KING)	DME/TACAN TEST PANEL
KDI-574	ASI-357	NMN	NPN	HONEYWELL (BENDIX/KING)	DME/TACAN TEST PANEL
KDM-7000	ASI-776-4	NMN	696-2795-00	HONEYWELL (BENDIX/KING)	DME TEST AND PINOUT PANEL
KDM-706	ASI-357	NMN	NPN	HONEYWELL (BENDIX/KING)	DME/TACAN TEST PANEL
KDM-7060	ASI-776-1	NMN	002-00608-0000	HONEYWELL (BENDIX/KING)	DME TEST PANEL
KDM-706A	ASI-200-16	NMN	NPN	HONEYWELL (BENDIX/KING)	ASI-2000 PLUG-IN ADAPTER
KDM-706A	ASI-2002	NMN	NPN	HONEYWELL (BENDIX/KING)	GOLD CROWN APPLE IIe COMPUTER SYSTEM
KDM-706A	ASI-776-2	NMN	002-00609-0000	HONEYWELL (BENDIX/KING)	DME TEST PANEL
KDM-7070	ASI-776-3	NMN	002-00615-0000	HONEYWELL (BENDIX/KING)	DME TEST PANEL
KFS-564A	ASI-2002	NMN	NPN	HONEYWELL (BENDIX/KING)	GOLD CROWN APPLE IIe COMPUTER SYSTEM
KFS-564A	ASI-200-7	NMN	NPN	HONEYWELL (BENDIX/KING)	ASI-2000 PLUG-IN ADAPTER
KFS-564A	ASI-71	NMN	NPN	HONEYWELL (BENDIX/KING)	POWER SUPPLY FOR OPERATION WITH ASI-70B
KFS-576A	ASI-2002	NMN	NPN	HONEYWELL (BENDIX/KING)	GOLD CROWN APPLE IIe COMPUTER SYSTEM
KFS-576A	ASI-200-7	NMN	NPN	HONEYWELL (BENDIX/KING)	ASI-2000 PLUG-IN ADAPTER
KFS-576A	ASI-71	NMN	NPN	HONEYWELL (BENDIX/KING)	POWER SUPPLY FOR OPERATION WITH ASI-70B
KFS-578A	ASI-284	NMN	NPN	HONEYWELL (BENDIX/KING)	TEST FIXTURE
KFS-578A	ASI-71	NMN	NPN	HONEYWELL (BENDIX/KING)	POWER SUPPLY FOR OPERATION WITH ASI-70B
KFS-579A	ASI-2002	NMN	NPN	HONEYWELL (BENDIX/KING)	GOLD CROWN APPLE IIe COMPUTER SYSTEM
KFS-579A	ASI-200-7	NMN	NPN	HONEYWELL (BENDIX/KING)	ASI-2000 PLUG-IN ADAPTER
KFS-579A	ASI-71	NMN	NPN	HONEYWELL (BENDIX/KING)	POWER SUPPLY FOR OPERATION WITH ASI-70B
KFS-586A	ASI-2002	NMN	NPN	HONEYWELL (BENDIX/KING)	GOLD CROWN APPLE IIe COMPUTER SYSTEM
KFS-586A	ASI-200-7	NMN	NPN	HONEYWELL (BENDIX/KING)	ASI-2000 PLUG-IN ADAPTER
KFS-586A	ASI-71	NMN	NPN	HONEYWELL (BENDIX/KING)	POWER SUPPLY FOR OPERATION WITH ASI-70B
KFS-594	ASI-708-1	KTS-157	071-5040-00	HONEYWELL (BENDIX/KING)	HF/SSB TEST SET (REQUIRES ASI-70-8A)
KFS-594	ASI-793	NMN	155-1442-00	HONEYWELL (BENDIX/KING)	SYSTEM TEST HARNESS
KFS-598A	ASI-2002	NMN	NPN	HONEYWELL (BENDIX/KING)	GOLD CROWN APPLE IIe COMPUTER SYSTEM
KFS-598A	ASI-200-7	NMN	NPN	HONEYWELL (BENDIX/KING)	ASI-2000 PLUG-IN ADAPTER
KFS-598A	ASI-71	NMN	NPN	HONEYWELL (BENDIX/KING)	POWER SUPPLY FOR OPERATION WITH ASI-70B
KFS-599A/599B	ASI-782	NMN	NPN	HONEYWELL (BENDIX/KING)	KFS-599A/B TEST PANEL
KHF-1050	ASI-793-1	NMN	NPN	HONEYWELL (BENDIX/KING)	SYSTEM TEST HARNESS
KHF-990	ASI-793	NMN	155-1442-00	HONEYWELL (BENDIX/KING)	SYSTEM TEST HARNESS
KI-250	ASI-428-2	NMN	696-6257-00	HONEYWELL (BENDIX/KING)	KRA-10() BENCH TEST SET
KLN-35A	ASI-785	NMN	NPN	HONEYWELL (BENDIX/KING)	KLN TEST PANEL
KLN-89	ASI-785	NMN	NPN	HONEYWELL (BENDIX/KING)	KLN TEST PANEL
KLN-90	ASI-785	NMN	NPN	HONEYWELL (BENDIX/KING)	KLN TEST PANEL
KLN-900	ASI-781	NMN	NPN	HONEYWELL (BENDIX/KING)	KLN-900 TEST PANEL
KLN-94	ASI-785	NMN	NPN	HONEYWELL (BENDIX/KING)	KLN TEST PANEL
kix-135	ASI-116	NMN	NPN	HONEYWELL (BENDIX/KING)	GPS TEST PANEL
KMA-24/24H	ASI-794	NMN	NPN	HONEYWELL (BENDIX/KING)	KMA-24 TEST PANEL
KMD-540	ASI-784	NMN	071-00168-0000	HONEYWELL (BENDIX/KING)	KMD-540 TEST SET
KN-62/62A	ASI-357	NMN	NPN	HONEYWELL (BENDIX/KING)	DME/TACAN TEST PANEL
KN-63	ASI-357	NMN	NPN	HONEYWELL (BENDIX/KING)	DME/TACAN TEST PANEL
KN-64	ASI-357	NMN	NPN	HONEYWELL (BENDIX/KING)	DME/TACAN TEST PANEL
KNI-520	ASI-166	479X-2	522-0167-001	HONEYWELL (BENDIX/KING)	RESOLVER ZEROING PANEL
KNR-6030	ASI-221	968Y-1	622-4768-001	HONEYWELL (BENDIX/KING)	ARINC 547 VOR/ILS TEST SET

ASI TEST EQUIPMENT UNIT UNDER TEST (UUT) CROSS REFERENCE

UNIT TESTED	ASI MN	EQUIV MN	EQUIV PN	EQUIV OEM	DESCRIPTION
KNR-634/634A	ASI-791	NMN	002-00566-0000	HONEYWELL (BENDIX/KING)	KNR TEST PANEL
KPA-1052	ASI-793-1	NMN	NPN	HONEYWELL (BENDIX/KING)	SYSTEM TEST HARNESS
KPI-552()	ASI-428-1	NMN	002-0518-00	HONEYWELL (BENDIX/KING)	TEST PANEL
KPI-553()	ASI-428-1	NMN	002-0518-00	HONEYWELL (BENDIX/KING)	TEST PANEL
KPS-282	ASI-362	NMN	696-05641-0001	HONEYWELL (BENDIX/KING)	KAD-280 TEST SET
KRA-10A	ASI-428-2	NMN	696-6257-00	HONEYWELL (BENDIX/KING)	KRA-10() BENCH TEST SET
KRA-10A	ASI-428-2	NMN	696-6257-00	HONEYWELL (BENDIX/KING)	KRA-10() BENCH TEST SET
KRA-405	ASI-494	NMN	NPN	HONEYWELL (BENDIX/KING)	KRA-405 TEST SET
KRA-405B	ASI-495	NMN	050-03485-0000	HONEYWELL (BENDIX/KING)	KRA-405B TEST SET
KRX-1052	ASI-793-1	NMN	NPN	HONEYWELL (BENDIX/KING)	SYSTEM TEST HARNESS
KTR-9100/9100A	ASI-425	RTT-41A	2037676-0501	HONEYWELL (BENDIX/KING)	VHF TRANSCIVER TEST PANEL
KTR-953	ASI-708-1	KTS-157	071-5040-00	HONEYWELL (BENDIX/KING)	HF/SSB TEST SET
KTR-993	ASI-793	NMN	155-1442-00	HONEYWELL (BENDIX/KING)	SYSTEM TEST HARNESS
KTS-283	ASI-362	NMN	696-05641-0001	HONEYWELL (BENDIX/KING)	KAD-280 TEST SET
KTU-709	ASI-357	NMN	NPN	HONEYWELL (BENDIX/KING)	DME/TACAN TEST PANEL
KVG-350	ASI-361	NMN	696-4825-00	HONEYWELL (BENDIX/KING)	KVG-350 TEST PANEL
KX-155	ASI-794	NMN	002-00544-0000	HONEYWELL (BENDIX/KING)	KX-155/165 SYSTEM BENCH TEST SET
KX-165	ASI-794	NMN	002-00544-0000	HONEYWELL (BENDIX/KING)	KX-155/165 SYSTEM BENCH TEST SET
LRA-700	ASI-700-3	NMN	NPN	ROCKWELL COLLINS	DME/LRA DISCRETE FUNCTION INTERFACE UNIT
LRA-700	ASI-716	MST-905	622-6104-001	ROCKWELL COLLINS	MICROPROCESSOR TEST ADAPTER
LRA-700	ASI-717	NMN	NPN	ROCKWELL COLLINS	ALTITUDE SIMULATION FIXTURE
LRA-700	ASI-718	NMN	NPN	ROCKWELL COLLINS	RF TUNING COVER
LRA-700	ASI-719	NMN	NPN	ROCKWELL COLLINS	PULSE GENERATOR TEST BOX
LRA-900	ASI-700-3	NMN	NPN	ROCKWELL COLLINS	DME/LRA DISCRETE FUNCTION INTERFACE UNIT
LWA-200	ASI-211	NMN	NPN	ROCKWELL COLLINS	DUAL SYSTEM/LONG WIRE ADAPTER TEST SET
MC-103	ASI-40Y-25	440Y-25	777-1044-001	ROCKWELL COLLINS	980L-1 PLUG-IN ADAPTER
MCS-65	ASI-412	CTS-64	622-6459-001	ROCKWELL COLLINS	COMPASS SYSTEM TEST PANEL
MFD-85	ASI-392	NMN	NPN	ROCKWELL COLLINS	DATA ANALYZER TEST SET
MFD-85	ASI-417-1	CTS-855	622-6457-011	ROCKWELL COLLINS	ELECTRONICS FLIGHT DISPLAY SYSTEM TEST PANEL
MFD-85	ASI-418	CTS-858	622-7321-001	ROCKWELL COLLINS	EFD/MFD GAIN POSITION CALIBRATOR
MPU-85	ASI-CTS-9	CTS-9	622-6720-001	ROCKWELL COLLINS	UNIVERSAL ATR BREAKOUT BOX
MPU-86	ASI-CTS-9	CTS-9	622-6720-001	ROCKWELL COLLINS	UNIVERSAL ATR BREAKOUT BOX
MSI-80()	ASI-415-1	970D-1A	622-5811-001	ROCKWELL COLLINS	ADS AIR DATA TEST PANEL
MT-1508A	ASI-426	RCT-1500A	3614129-1501	HONEYWELL (BENDIX/KING)	RADAR SYSTEM TEST PANEL
MT-195/ARA-50	ASI-789	AN/ARM-102	522-4545-001	ROCKWELL COLLINS	DIRECTION FINDER GROUP TEST SET
MT-195/ARA-50	ASI-789-1	TS-2544/ARM-102	522-4817-001	ROCKWELL COLLINS	DIRECTION FINDER TEST SET
MT-195/ARA-50	ASI-789-2	MT-3726/ARM-102	522-4818-001	ROCKWELL COLLINS	DIRECTION FINDER TEST SET MOUNT
MX-10191()	ASI-226	514M-2	622-7082-001	ROCKWELL COLLINS	INTERFACE PANEL
MX-9577()	ASI-226	514M-2	622-7082-001	ROCKWELL COLLINS	INTERFACE PANEL
NAC-80	ASI-40Y-67A	440Y-67A	622-4086-001	ROCKWELL COLLINS	980L-1 PLUG-IN ADAPTER
NCS-31()	ASI-295	971K-1	522-2011-001	ROCKWELL COLLINS	AREA NAVIGATION SYSTEM TEST PANEL
OA-8697/ARD	ASI-790	970V-1	622-3029-001	ROCKWELL COLLINS	DIRECTION FINDER TEST SET
OD-122	ASI-308-2	AN/ARM-165A	622-2750-001	ROCKWELL COLLINS	RADIO TEST SET
PAC-200	ASI-338-3	CTS-202	622-4283-001	ROCKWELL COLLINS	TRANSCIVER-PA TEST PANEL
PAC-200	ASI-338-4	CTS-203	622-4285-001	ROCKWELL COLLINS	COUPLERT LOGIC TEST PANEL
PAC-230	ASI-338-3	CTS-202	622-4283-001	ROCKWELL COLLINS	TRANSCIVER-PA TEST PANEL
PAC-230	ASI-338-4	CTS-203	622-4285-001	ROCKWELL COLLINS	COUPLERT LOGIC TEST PANEL
PAU-700	ASI-720	NMN	NPN	ROCKWELL COLLINS	ATTENUATOR, 26 dB L-PAD
PAU-700	ASI-721	NMN	NPN	ROCKWELL COLLINS	PAU-700 TEST FIXTURE
PPI-1D	ASI-171	RDT-1A	2037736-0501	HONEYWELL (BENDIX)	RDR-1 RADAR SYSTEM TEST PANEL
PPI-1D	ASI-173	PPT-1A	2037738-0501	HONEYWELL (BENDIX)	PPI-1() RADAR INDICATOR TEST SET
PPI-1E	ASI-171	RDT-1A	2037736-0501	HONEYWELL (BENDIX)	RDR-1 RADAR SYSTEM TEST PANEL
PPI-1E-1	ASI-171	RDT-1A	2037736-0501	HONEYWELL (BENDIX)	RDR-1 RADAR SYSTEM TEST PANEL
PPI-1E-2	ASI-171	RDT-1A	2037736-0501	HONEYWELL (BENDIX)	RDR-1 RADAR SYSTEM TEST PANEL
PPI-1E-2	ASI-173	PPT-1A	2037738-0501	HONEYWELL (BENDIX)	PPI-1() RADAR INDICATOR TEST SET
PPI-1G	ASI-171	RDT-1A	2037736-0501	HONEYWELL (BENDIX)	RDR-1 RADAR SYSTEM TEST PANEL
PPI-1G	ASI-173	PPT-1A	2037738-0501	HONEYWELL (BENDIX)	PPI-1() RADAR INDICATOR TEST SET
PPI-1GT	ASI-171	RDT-1A	2037736-0501	HONEYWELL (BENDIX)	RDR-1 RADAR SYSTEM TEST PANEL
PPI-1GT	ASI-173	PPT-1A	2037738-0501	HONEYWELL (BENDIX)	PPI-1() RADAR INDICATOR TEST SET
PPI-1L	ASI-154-1	RCT-1F	2038326-0501	HONEYWELL (BENDIX)	RADAR SYSTEM TEST PANEL
PPI-1L	ASI-174	PPT-1B	2038141-0501	HONEYWELL (BENDIX)	PPI-1() RADAR INDICATOR TEST SET
PPI-1M	ASI-171	RDT-1A	2037736-0501	HONEYWELL (BENDIX)	RDR-1 RADAR SYSTEM TEST PANEL
PPI-1N	ASI-174	PPT-1B	2038141-0501	HONEYWELL (BENDIX)	PPI-1() RADAR INDICATOR TEST SET
PPI-1P	ASI-171	RDT-1A	2037736-0501	HONEYWELL (BENDIX)	RDR-1 RADAR SYSTEM TEST PANEL
PPI-1P	ASI-174	PPT-1B	2038141-0501	HONEYWELL (BENDIX)	PPI-1() RADAR INDICATOR TEST SET
PPI-1S	ASI-197	PPT-1CG	2041323-0101	HONEYWELL (BENDIX)	RADAR TEST PATTERN GENERATOR
PPI-1S	ASI-198	NMN	2039597-0501	HONEYWELL (BENDIX)	RADAR TEST PATTERN GENERATOR ADAPTER
PPI-1T	ASI-174	PPT-1B	2038141-0501	HONEYWELL (BENDIX)	PPI-1() RADAR INDICATOR TEST SET
PPI-1T	ASI-197	PPT-1CG	2041323-0101	HONEYWELL (BENDIX)	TEST PATTERN GENERATOR
PPI-1T	ASI-743	AIT-4A	8074503-0401	HONEYWELL (BENDIX)	TCAS PPT ADAPTER PANEL
PPI-1TB	ASI-154-2	RCT-1FB	2041349-0102	HONEYWELL (BENDIX)	RDR-1FB RADAR TEST PANEL
PPI-1TB	ASI-244-1	PPT-1FB	2041350-0101	HONEYWELL (BENDIX)	RADAR INDICATOR TEST PANEL
PPI-1TB(M)	ASI-154-2	RCT-1FB	2041349-0102	HONEYWELL (BENDIX)	RDR-1FB RADAR TEST PANEL
PPI-1TB(M)	ASI-244-2	PPT-1FB	2041350-0102	HONEYWELL (BENDIX)	RADAR INDICATOR TEST PANEL
PPI-1U	ASI-174	PPT-1B	2038141-0501	HONEYWELL (BENDIX)	PPI-1() RADAR INDICATOR TEST SET

ASI TEST EQUIPMENT UNIT UNDER TEST (UUT) CROSS REFERENCE

UNIT TESTED	ASI MN	EQUIV MN	EQUIV PN	EQUIV OEM	DESCRIPTION
PPI-1U	ASI-197	PPT-1CG	2041323-0101	HONEYWELL (BENDIX)	RADAR TEST PATTERN GENERATOR
PPI-1U	ASI-198	NMN	2039597-0501	HONEYWELL (BENDIX)	RADAR TEST PATTERN GENERATOR ADAPTER
PPI-1U	ASI-743	AIT-4A	8074503-0401	HONEYWELL (BENDIX)	TCAS PPT ADAPTER PANEL
PPI-4B	ASI-197	PPT-1CG	2041323-0101	HONEYWELL (BENDIX)	TEST PATTERN GENERATOR
PPI-4B	ASI-742	RCT-4A	2041589-0401	HONEYWELL (BENDIX)	RADAR SYSTEM TEST PANEL
PPI-4B	ASI-743	AIT-4A	8074503-0401	HONEYWELL (BENDIX)	TCAS PPT ADAPTER PANEL
PPI-4B	ASI-760	PPT-4A	2041591-0401	HONEYWELL (BENDIX)	RADAR INDICATOR TEST PANEL
PPI-IU	ASI-743	AIT-4A	8074503-0401	HONEYWELL (BENDIX)	TCAS PPT ADAPTER PANEL
PRA-83()	ASI-422	CPT-83A	2041065-8301	HONEYWELL (BENDIX)	GPW SYSTEM TEST PANEL
PRE-80()	ASI-415-1	970D-1A	622-5811-001	ROCKWELL COLLINS	ADS AIR DATA TEST PANEL
PRIMUS-300	ASI-163	NMN	NPN	HONEYWELL (SPERRY)	PRIMUS RADAR SYSTEM TEST PANEL
PRIMUS-40	ASI-163	NMN	NPN	HONEYWELL (SPERRY)	PRIMUS RADAR SYSTEM TEST PANEL
PRIMUS-400	ASI-163	NMN	NPN	HONEYWELL (SPERRY)	PRIMUS RADAR SYSTEM TEST PANEL
PRIMUS-500	ASI-163	NMN	NPN	HONEYWELL (SPERRY)	PRIMUS RADAR SYSTEM TEST PANEL
PRIMUS-90	ASI-163	NMN	NPN	HONEYWELL (SPERRY)	PRIMUS RADAR SYSTEM TEST PANEL
PS-440	ASI-793-1	NMN	NPN	HONEYWELL (BENDIX/KING)	SYSTEM TEST HARNESS
PS-823()	ASI-195	NMN	NPN	L3 (JET)	POWER SUPPLY TEST SET
PS-834()	ASI-196-2	JT-135A	570-7936-01	L3 (JET)	POWER SUPPLY TEST SET
PS-835()	ASI-196	NMN	NPN	L3 (JET)	POWER SUPPLY TEST SET
PS-850()	ASI-196-1	JT-138A	570-7996-01	L3 (JET)	PS-850/855 POWER SUPPLY TEST PANEL
PS-855()	ASI-196-1	JT-138A	570-7996-01	L3 (JET)	PS-850/855 POWER SUPPLY TEST PANEL
PWR-200	ASI-338-3	CTS-202	622-4283-001	ROCKWELL COLLINS	TRANSCEIVER-PA TEST PANEL
PWR-230	ASI-338-3	CTS-202	622-4283-001	ROCKWELL COLLINS	TRANSCEIVER-PA TEST PANEL
R-1391	ASI-201-1	AN/ARM-93	522-4458-001	ROCKWELL COLLINS	ADF TEST SET
R-1963	ASI-177-2-04	RNT-260A	4000951-6004	HONEYWELL (BENDIX)	VOR/ILS SYSTEM TEST PANEL
R-2023	ASI-177-2	RNT-260A	4000951-6002	HONEYWELL (BENDIX)	VOR/ILS SYSTEM TEST PANEL
R-2032	ASI-177-2-04	RNT-260A	4000951-6004	HONEYWELL (BENDIX)	VOR/ILS SYSTEM TEST PANEL
R-2139	ASI-177-2	RNT-260A	4000951-6002	HONEYWELL (BENDIX)	VOR/ILS SYSTEM TEST PANEL
R-2274	ASI-376-1	966Y-2	622-6926-001	ROCKWELL COLLINS	VOR/ILS TEST PANEL
R-2325	ASI-177-2-04	RNT-260A	4000951-6004	HONEYWELL (BENDIX)	VOR/ILS SYSTEM TEST PANEL
R-2325	ASI-376-1	966Y-2	622-6926-001	ROCKWELL COLLINS	VOR/ILS TEST PANEL
R-2382	ASI-375-1	970G-2	622-7345-001	ROCKWELL COLLINS	ADF TEST PANEL
R-2382	ASI-61W	970W-1	622-3099-001	ROCKWELL COLLINS	ADF ANTENNA SIMULATOR
R-2383	ASI-375-1	970G-2	622-7345-001	ROCKWELL COLLINS	ADF TEST PANEL
R-2383	ASI-61W	970W-1	622-3099-001	ROCKWELL COLLINS	ADF ANTENNA SIMULATOR
R-2492	ASI-376-1	966Y-2	622-6926-001	ROCKWELL COLLINS	VOR/ILS TEST PANEL
R-2494	ASI-376-1	966Y-2	622-6926-001	ROCKWELL COLLINS	VOR/ILS TEST PANEL
R-2593	ASI-376-1	966Y-2	622-6926-001	ROCKWELL COLLINS	VOR/ILS TEST PANEL
RAC-870	ASI-132	NMN	NPN	ROCKWELL COLLINS	PRO LINE RAC / CAD TEST PANEL
RAC-870	ASI-200-18	NMN	NPN	ROCKWELL COLLINS	ASI-2000 PLUG-IN ADAPTER
RAI-742	ASI-700-1	NMN	NPN	ROCKWELL COLLINS	DFIU TEST SET
RCP-65	ASI-412	CTS-64	622-6459-001	ROCKWELL COLLINS	MCS-65 COMPASS SYSTEM TEST PANEL
RDMI-743	ASI-700-1	NMN	NPN	ROCKWELL COLLINS	DFIU TEST SET
RDMI-743	ASI-702	NMN	NPN	ROCKWELL COLLINS	DEM TESTER
RDMI-743	ASI-703	NMN	NPN	ROCKWELL COLLINS	CALIBRATION FIXTURE
RDMI-743	ASI-704	NMN	NPN	ROCKWELL COLLINS	POWER SUPPLY TESTER
RDMI-743A	ASI-700-1	NMN	NPN	ROCKWELL COLLINS	DFIU TEST SET
RDMI-743A	ASI-702	NMN	NPN	ROCKWELL COLLINS	DEM TESTER
RDMI-743A	ASI-703	NMN	NPN	ROCKWELL COLLINS	CALIBRATION FIXTURE
RDMI-743A	ASI-703	NMN	NPN	ROCKWELL COLLINS	POWER SUPPLY TESTER
RDR-1100	ASI-360	NMN	NPN	HONEYWELL (SPERRY)	RDR RADAR SYSTEM TEST PANEL
RDR-1150	ASI-360	NMN	NPN	HONEYWELL (SPERRY)	RDR RADAR SYSTEM TEST PANEL
RDR-1200	ASI-360	NMN	NPN	HONEYWELL (SPERRY)	RDR RADAR SYSTEM TEST PANEL
RDR-130	ASI-360	NMN	NPN	HONEYWELL (SPERRY)	RDR RADAR SYSTEM TEST PANEL
RDR-1300	ASI-360	NMN	NPN	HONEYWELL (SPERRY)	RDR RADAR SYSTEM TEST PANEL
RDR-140	ASI-360	NMN	NPN	HONEYWELL (SPERRY)	RDR RADAR SYSTEM TEST PANEL
RDR-1400B	ASI-360	NMN	NPN	HONEYWELL (SPERRY)	RDR RADAR SYSTEM TEST PANEL
RDR-1400C	ASI-360	NMN	NPN	HONEYWELL (SPERRY)	RDR RADAR SYSTEM TEST PANEL
RDR-150	ASI-360	NMN	NPN	HONEYWELL (SPERRY)	RDR RADAR SYSTEM TEST PANEL
RDR-160	ASI-360	NMN	NPN	HONEYWELL (SPERRY)	RDR RADAR SYSTEM TEST PANEL
RDR-1E	ASI-169	RST-1A	2064746-0501	HONEYWELL (BENDIX)	RDR-1E/ED STABILIZATION RAMP TEST SET
RDR-1E	ASI-171	RDT-1A	2037736-0501	HONEYWELL (BENDIX)	RDR-1() RADAR TEST SET
RDR-1ED	ASI-169	RST-1A	2064746-0501	HONEYWELL (BENDIX)	RDR-1E/ED STABILIZATION RAMP TEST SET
RDR-1ED	ASI-171	RDT-1A	2037736-0501	HONEYWELL (BENDIX)	RDR-1() RADAR TEST SET
RDR-1F	ASI-152-1	RDT-1F	2038139-0501	HONEYWELL (BENDIX)	RDR-1F RADAR TEST SET
RDR-1F	ASI-154-1	RCT-1F	2038326-0501	HONEYWELL (BENDIX)	RDR-1F RADAR SYSTEM TEST PANEL
RDR-1F	ASI-170	RFT-1A	2038142-0501	HONEYWELL (BENDIX)	RDR-1F RADAR RAMP TEST SET
RDR-1FB	ASI-154-2	RCT-1FB	2041349-0101	HONEYWELL (BENDIX)	RADAR SYSTEM TEST PANEL
RDR-2000	ASI-783	NMN	NPN	HONEYWELL	RDR-2000/2100 RADAR SYSTEM TEST SET
RDR-2100	ASI-783	NMN	NPN	HONEYWELL	RDR-2000/2100 RADAR SYSTEM TEST SET
RDR-4A	ASI-169-2	RST-4A	2041797-0401	HONEYWELL (BENDIX)	PORTABLE RADAR TEST SET
RDR-4A	ASI-741	RMT-4A	8055325-0401	HONEYWELL (BENDIX)	DOPPLER SIGNAL GENERATOR
RDR-4A	ASI-742	RCT-4A	2041589-0401	HONEYWELL (BENDIX)	RADAR SYSTEM TEST PANEL
RDR-4A	ASI-770	AST-4A	2041886-0401	HONEYWELL (BENDIX)	RADAR ANTENNA SIMULATOR PANEL
RDS-81	ASI-786	NMN	NPN	HONEYWELL (BENDIX/KING)	RDS RADAR SYSTEM TEST SET

ASI TEST EQUIPMENT UNIT UNDER TEST (UUT) CROSS REFERENCE

UNIT TESTED	ASI MN	EQUIV MN	EQUIV PN	EQUIV OEM	DESCRIPTION
RDS-82	ASI-786	NMN	NPN	HONEYWELL (BENDIX/KING)	RDS RADAR SYSTEM TEST SET
RDS-84	ASI-786	NMN	NPN	HONEYWELL (BENDIX/KING)	RDS RADAR SYSTEM TEST SET
RDS-86	ASI-786	NMN	NPN	HONEYWELL (BENDIX/KING)	RDS RADAR SYSTEM TEST SET
RDT-4A	ASI-169-2	RST-4A	2041797-0401	HONEYWELL (BENDIX)	PORTABLE RADAR TEST SET
REA-4()	ASI-771	ATT-4A	2041592-0401	HONEYWELL (BENDIX)	RADAR ANTENNA TEST PANEL
RIA-32A	ASI-413-1	RIT-32A	2070809-3201	HONEYWELL (BENDIX)	ILS RECEIVER TEST PANEL
RIA-32A	ASI-413-2	RIG-32A	2070776-3201	HONEYWELL (BENDIX)	ILS AUDIO GENERATOR
RIA-35A	ASI-700-2	NMN	NPN	HONEYWELL (BENDIX)	ADF/ILS/MB/VOR DFIU
RIA-35A	ASI-805	RNT-30A	2041634-3003	HONEYWELL (BENDIX)	NAV TEST PANEL
RIA-35B	ASI-805	RNT-30A	2041634-3003	HONEYWELL (BENDIX)	NAV TEST PANEL
RMI-30	ASI-167	978F-2S	522-3498-000	ROCKWELL COLLINS	SYNCHRO SIMULATOR
RMI-30	ASI-187	970E-1	622-2914-001	ROCKWELL COLLINS	RMI TEST PANEL
RMI-36	ASI-167	978F-2S	522-3498-000	ROCKWELL COLLINS	SYNCHRO SIMULATOR
RMI-36	ASI-187	970E-1	622-2914-001	ROCKWELL COLLINS	RMI TEST PANEL
RMI-733	ASI-700-1	NMN	NPN	ROCKWELL COLLINS	DFIU TEST SET
RMI-733	ASI-702	NMN	NPN	ROCKWELL COLLINS	DEM TESTER
RMI-733	ASI-702	NMN	NPN	ROCKWELL COLLINS	DEM TESTER
RMI-733	ASI-703	NMN	NPN	ROCKWELL COLLINS	CALIBRATION FIXTURE
RMI-733	ASI-703	NMN	NPN	ROCKWELL COLLINS	CALIBRATION FIXTURE
RMI-733	ASI-703	NMN	NPN	ROCKWELL COLLINS	POWER SUPPLY TESTER
RMI-733	ASI-703	NMN	NPN	ROCKWELL COLLINS	POWER SUPPLY TESTER
RMI-733A	ASI-700-1	NMN	NPN	ROCKWELL COLLINS	DFIU TEST SET
RMI-733A	ASI-702	NMN	NPN	ROCKWELL COLLINS	DEM TESTER
RMI-733A	ASI-703	NMN	NPN	ROCKWELL COLLINS	CALIBRATION FIXTURE
RMI-733A	ASI-703	NMN	NPN	ROCKWELL COLLINS	POWER SUPPLY TESTER
RN-260B	ASI-177-2-04	RNT-260A	4000951-6004	HONEYWELL (BENDIX)	VOR/ILS SYSTEM TEST PANEL
RN-262B	ASI-177-2-04	RNT-260A	4000951-6004	HONEYWELL (BENDIX)	VOR/ILS SYSTEM TEST PANEL
RNA-26C	ASI-177-1	RNT-26A	2064139-0501	HONEYWELL (BENDIX)	VHF NAVIGATION RECEIVER TEST PANEL
RNA-26C	ASI-221-1	968Y-1	622-4768-001	ROCKWELL COLLINS	ARINC 547 VOR/ILS TEST SET
RNA-26CF	ASI-177-1	RNT-26A	2064139-0501	HONEYWELL (BENDIX)	VHF NAVIGATION RECEIVER TEST PANEL
RNA-34A	ASI-177-1	RNT-26A	2064139-0501	HONEYWELL (BENDIX)	VHF NAVIGATION RECEIVER TEST PANEL
RNA-34A	ASI-221-1	968Y-1	622-4768-001	ROCKWELL COLLINS	ARINC 547 VOR/ILS TEST SET
RNA-34A	ASI-413-2	RIG-32A	2070776-3201	HONEYWELL (BENDIX)	ILS AUDIO GENERATOR
RNA-34A	ASI-420-1	RNT-34A	2041341-3401	HONEYWELL (BENDIX)	VHF NAVIGATION RECEIVER TEST PANEL
RNA-34A	ASI-424-2	RVG-33A	2070810-3301	HONEYWELL (BENDIX)	VOR AUDIO GENERATOR
RNA-34AF	ASI-177-1	RNT-26A	2064139-0501	HONEYWELL (BENDIX)	VHF NAVIGATION RECEIVER TEST PANEL
RNA-34AF	ASI-420-2	ADT-34AF	3614307-3401	HONEYWELL (BENDIX)	VHF NAVIGATION RECEIVER TEST PANEL
RNC-300	ASI-298	CTS-301	622-5225-001	ROCKWELL COLLINS	RADAR NAV TEST SET
RNC-300	ASI-60-1,-2,-3	CTS-10	622-4561-001	ROCKWELL COLLINS	BREAKOUT EXTENDER CABLE
RNC-300	ASI-CTS-10	CTS-10	622-4561-00	ROCKWELL COLLINS	UNIVERSAL ATR BREAKOUT BOX
RNC-300A	ASI-298	CTS-301	622-5225-001	ROCKWELL COLLINS	RADAR NAV TEST SET
RNC-300A	ASI-60-1,-2,-3	CTS-10	622-4561-001	ROCKWELL COLLINS	BREAKOUT EXTENDER CABLE
RNI-30	ASI-187	970E-1	622-2914-001	ROCKWELL COLLINS	RMI TEST PANEL
RNI-36	ASI-187	970E-1	622-2914-001	ROCKWELL COLLINS	RMI TEST PANEL
RNS-300	ASI-298	CTS-301	622-5225-001	ROCKWELL COLLINS	RADAR NAV TEST SET
RNS-300	ASI-60-1,-2,-3	CTS-10	622-4561-001	ROCKWELL COLLINS	BREAKOUT EXTENDER CABLE
RNS-300A	ASI-298	CTS-301	622-5225-001	ROCKWELL COLLINS	RADAR NAV TEST SET
RNS-300A	ASI-60-1,-2,-3	CTS-10	622-4561-001	ROCKWELL COLLINS	BREAKOUT EXTENDER CABLE
RNS-325	ASI-298	CTS-301	622-5225-001	ROCKWELL COLLINS	RADAR NAV TEST SET
RNS-325	ASI-60-1,-2,-3	CTS-10	622-4561-001	ROCKWELL COLLINS	BREAKOUT EXTENDER CABLE
RNS-325A	ASI-298	CTS-301	622-5225-001	ROCKWELL COLLINS	RADAR NAV TEST SET
RNS-325A	ASI-60-1,-2,-3	CTS-10	622-4561-001	ROCKWELL COLLINS	BREAKOUT EXTENDER CABLE
RS-181A	ASI-786	NMN	NPN	HONEYWELL (BENDIX/KING)	RDS RADAR SYSTEM TEST SET
RS-811A	ASI-786	NMN	NPN	HONEYWELL (BENDIX/KING)	RDS RADAR SYSTEM TEST SET
RS-841A	ASI-786	NMN	NPN	HONEYWELL (BENDIX/KING)	RDS RADAR SYSTEM TEST SET
RS-861A	ASI-786	NMN	NPN	HONEYWELL (BENDIX/KING)	RDS RADAR SYSTEM TEST SET
RT-1150	ASI-308-2	AN/ARM-165A	622-2750-001	ROCKWELL COLLINS	RADIO TEST SET
RT-1151A	ASI-360	NMN	NPN	HONEYWELL (BENDIX/KING)	RDR RADAR SYSTEM TEST PANEL
RT-1194	ASI-308-2	AN/ARM-165A	622-2750-001	ROCKWELL COLLINS	RADIO TEST SET
RT-1201A	ASI-1207A	TS-1207A	4000595-0701	HONEYWELL (BENDIX/KING)	RADAR TEST SET
RT-1201A	ASI-360	NMN	NPN	HONEYWELL (BENDIX/KING)	RDR RADAR SYSTEM TEST PANEL
RT-1250()	ASI-300	973W-2	622-5058-001	ROCKWELL COLLINS	RADIO TEST SET
RT-1250()	ASI-301	973W-3	622-6121-001	ROCKWELL COLLINS	RADIO TEST SET
RT-1272()	ASI-321B	969N-1B	622-5655-001	ROCKWELL COLLINS	AUDIO TEST FIXTURE
RT-1272()	ASI-321D	969N-1D	622-8014-001	ROCKWELL COLLINS	AUDIO TEST FIXTURE
RT-1299	ASI-2389-002	NMN	638-2389-002	ROCKWELL COLLINS	INTERCONNECT CABLE SET
RT-1299	ASI-2390-001	NMN	638-2390-001	ROCKWELL COLLINS	INTERCONNECT CABLE SET
RT-1299	ASI-4015-186	NMN	647-4015-001	ROCKWELL COLLINS	INTERCONNECT CABLE SET
RT-1300	ASI-2389-002	NMN	638-2389-002	ROCKWELL COLLINS	INTERCONNECT CABLE SET
RT-1300	ASI-2390-001	NMN	638-2390-001	ROCKWELL COLLINS	INTERCONNECT CABLE SET
RT-1300	ASI-4015-186	NMN	647-4015-001	ROCKWELL COLLINS	INTERCONNECT CABLE SET
RT-1301A/B	ASI-1207A	TS-1207A	4000595-0701	HONEYWELL (BENDIX/KING)	RADAR TEST SET
RT-1301A/B	ASI-360	NMN	NPN	HONEYWELL (BENDIX/KING)	RDR RADAR SYSTEM TEST PANEL
RT-131A	ASI-360	NMN	NPN	HONEYWELL (BENDIX/KING)	RDR RADAR SYSTEM TEST PANEL
RT-1324A	ASI-300	973W-2	622-5058-001	ROCKWELL COLLINS	RADIO TEST SET

ASI TEST EQUIPMENT UNIT UNDER TEST (UUT) CROSS REFERENCE

UNIT TESTED	ASI MN	EQUIV MN	EQUIV PN	EQUIV OEM	DESCRIPTION
RT-1324A	ASI-301	973W-3	622-6121-001	ROCKWELL COLLINS	RADIO TEST SET
RT-1327A	ASI-300	973W-2	622-5058-001	ROCKWELL COLLINS	RADIO TEST SET
RT-1327A	ASI-301	973W-3	622-6121-001	ROCKWELL COLLINS	RADIO TEST SET
RT-1341	ASI-323-21	966D-5A	622-7574-002	ROCKWELL COLLINS	RADIO SET TEST PANEL
RT-1341	ASI-323-3	966D-5B	622-9034-001	ROCKWELL COLLINS	RADIO SET TEST PANEL
RT-1354	ASI-2389-002	NMN	638-2389-002	ROCKWELL COLLINS	INTERCONNECT CABLE SET
RT-1354	ASI-2390-001	NMN	638-2390-001	ROCKWELL COLLINS	INTERCONNECT CABLE SET
RT-1354	ASI-4015-186	NMN	647-4015-001	ROCKWELL COLLINS	INTERCONNECT CABLE SET
RT-1360A	ASI-300	973W-2	622-5058-001	ROCKWELL COLLINS	RADIO TEST SET
RT-1360A	ASI-301	973W-3	622-6121-001	ROCKWELL COLLINS	RADIO TEST SET
RT-1369	ASI-321A	969N-1A	622-5532-001	ROCKWELL COLLINS	AUDIO TEST FIXTURE
RT-1385/A	ASI-226	514M-2	622-7082-001	ROCKWELL COLLINS	INTERFACE PANEL
RT-1401A/B	ASI-1207A	TS-1207A	4000595-0701	HONEYWELL (BENDIX/KING)	RADAR TEST SET
RT-1401A/B	ASI-360	NMN	NPN	HONEYWELL (BENDIX/KING)	RDR RADAR SYSTEM TEST PANEL
RT-1407	ASI-300	973W-2	622-5058-001	ROCKWELL COLLINS	RADIO TEST SET
RT-1407	ASI-301	973W-3	622-6121-001	ROCKWELL COLLINS	RADIO TEST SET
RT-1501A	ASI-1207A	TS-1207A	4000595-0701	HONEYWELL (BENDIX/KING)	RADAR TEST SET
RT-1501A	ASI-426	RCT-1500A	3614129-1501	HONEYWELL (BENDIX/KING)	RDR-1500 RADAR SYSTEM TEST PANEL
RT-1629	ASI-300	973W-2	622-5058-001	ROCKWELL COLLINS	RADIO TEST SET
RT-1629	ASI-301	973W-3	622-6121-001	ROCKWELL COLLINS	RADIO TEST SET
RT-300	ASI-492-1	NMN	T322967	HONEYWELL (SPERRY)	RADIO ALTIMETER TEST SET
RT-300	ASI-492-2	NMN	T334109	HONEYWELL (SPERRY)	RT-300 TEST SET ADAPTER
RT-980	ASI-321A	969N-1A	622-5532-001	ROCKWELL COLLINS	AUDIO TEST FIXTURE
RTA-1FB	ASI-152-2	RDT-1FB	2041351-0102	HONEYWELL (BENDIX)	RDR-1FB RADAR TEST PANEL
RTA-1FB	ASI-154-2	RCT-1FB	2041349-0102	HONEYWELL (BENDIX)	RDR-1FB RADAR TEST PANEL
RTA-1FB(M)	ASI-152-2	RDT-1FB	2041351-0102	HONEYWELL (BENDIX)	RDR-1FB RADAR TEST PANEL
RTA-1FB(M)	ASI-154-2	RCT-1FB	2041349-0102	HONEYWELL (BENDIX)	RDR-1FB RADAR TEST PANEL
RTA-1TB	ASI-154-2	RCT-1FB	2041349-0102	HONEYWELL (BENDIX)	RDR-1FB RADAR TEST PANEL
RTA-41A	ASI-425	RTT-41A	2037676-0501	HONEYWELL (BENDIX)	VHF TRANSCEIVER TEST PANEL
RTA-42A	ASI-425	RTT-41A	2037676-0501	HONEYWELL (BENDIX)	VHF TRANSCEIVER TEST PANEL
RTA-43A	ASI-425	RTT-41A	2037676-0501	HONEYWELL (BENDIX)	VHF TRANSCEIVER TEST PANEL
RTA-44A	ASI-700-4	NMN	NPN	HONEYWELL (BENDIX)	HF/VHF DESCETE FUNCTION INTERFACE PANEL
RTA-44A	ASI-803	RTT-44A	2041524-4401	HONEYWELL (BENDIX)	VHF COM TEST PANEL
RTA-4A	ASI-169-2	RST-4A	2041797-0401	HONEYWELL (BENDIX)	PORTABLE RADAR TEST SET
RTA-4A	ASI-741	RMT-4A	8055325-0401	HONEYWELL (BENDIX)	DOPPLER SIGNAL GENERATOR
RTA-4A	ASI-742	RCT-4A	2041589-0401	HONEYWELL (BENDIX)	RADAR SYSTEM TEST PANEL
RTA-4A	ASI-770	AST-4A	2041886-0401	HONEYWELL (BENDIX)	RADAR ANTENNA SIMULATOR PANEL
RTA-4A	ASI-799	AXT-4A	8055692-0401	HONEYWELL (BENDIX)	FAULT DATA UNIT
RTA-800	ASI-CTS-840	CTS-840	822-0080-001	ROCKWELL COLLINS	RADAR ABSORPTION BARRELL
RTA-800	ASI-CTS-841	CTS-841	822-0081-001	ROCKWELL COLLINS	RTA TEST PANEL
RTA-83A	ASI-425	RTT-41A	2037676-0501	HONEYWELL (BENDIX)	VHF TRANSCEIVER TEST PANEL
RTA-83A	ASI-700-4	NMN	NPN	HONEYWELL (BENDIX)	HF/VHF DESCETE FUNCTION INTERFACE PANEL
RTA-83A	ASI-803	RTT-44A	2041524-4401	HONEYWELL (BENDIX)	VHF COM TEST PANEL
RTA-83B	ASI-803	RTT-44A	2041524-4401	HONEYWELL (BENDIX)	VHF COM TEST PANEL
RTA-842	ASI-CTS-840	CTS-840	822-0080-001	ROCKWELL COLLINS	RADAR ABSORPTION BARRELL
RTA-842	ASI-CTS-841	CTS-841	822-0081-001	ROCKWELL COLLINS	RTA TEST PANEL
RTA-844	ASI-CTS-840	CTS-840	822-0080-001	ROCKWELL COLLINS	RADAR ABSORPTION BARRELL
RTA-844	ASI-CTS-841	CTS-841	822-0081-001	ROCKWELL COLLINS	RTA TEST PANEL
RTA-848	ASI-CTS-840	CTS-840	822-0080-001	ROCKWELL COLLINS	RADAR ABSORPTION BARRELL
RTA-848	ASI-CTS-841	CTS-841	822-0081-001	ROCKWELL COLLINS	RTA TEST PANEL
RTA-852	ASI-CTS-840	CTS-840	822-0080-001	ROCKWELL COLLINS	RADAR ABSORPTION BARRELL
RTA-852	ASI-CTS-841	CTS-841	822-0081-001	ROCKWELL COLLINS	RTA TEST PANEL
RTA-852L	ASI-CTS-840	CTS-840	822-0080-001	ROCKWELL COLLINS	RADAR ABSORPTION BARRELL
RTA-852L	ASI-CTS-841	CTS-841	822-0081-001	ROCKWELL COLLINS	RTA TEST PANEL
RTA-854	ASI-CTS-840	CTS-840	822-0080-001	ROCKWELL COLLINS	RADAR ABSORPTION BARRELL
RTA-854	ASI-CTS-841	CTS-841	822-0081-001	ROCKWELL COLLINS	RTA TEST PANEL
RTA-858	ASI-CTS-840	CTS-840	822-0080-001	ROCKWELL COLLINS	RADAR ABSORPTION BARRELL
RTA-858	ASI-CTS-841	CTS-841	822-0081-001	ROCKWELL COLLINS	RTA TEST PANEL
RTU-870	ASI-200-17	NMN	NPN	ROCKWELL COLLINS	ASI-2000 PLUG-IN ADAPTER
RTU-870A/T	ASI-133	NMN	NPN	ROCKWELL COLLINS	PRO LINE RTU TEST PANEL
RTU-870A/T	ASI-200-17A	NMN	NPN	ROCKWELL COLLINS	ASI-2000 PLUG-IN ADAPTER
RVA-33A	ASI-424-1	RVT-33A	2070811-3301	HONEYWELL (BENDIX)	VOR RECEIVER TEST PANEL
RVA-33A	ASI-424-2	RVG-33A	2070810-3301	HONEYWELL (BENDIX)	VOR AUDIO GENERATOR
RVA-36A	ASI-700-2	NMN	NPN	HONEYWELL (BENDIX)	ADF/ILS/MB/VOR DFIU
RVA-36A	ASI-805	RNT-30A	2041634-3003	HONEYWELL (BENDIX)	NAV TEST PANEL
S282T003-3	ASI-604-2	NMN	NPN	CRANE AEROSPACE (ELDEC)	BATTERY CHARGER TEST SET
SD-442A	ASI-810-3	92XD-1	01-0218-00	HONEYWELL (BENDIX/KING)	SERIES III / FLITELINE DME/XPDR SYSTEM TEST PANEL
SD-442B	ASI-810-3	92XD-1	01-0218-00	HONEYWELL (BENDIX/KING)	SERIES III / FLITELINE DME/XPDR SYSTEM TEST PANEL
SDD-640	ASI-CTS-10	CTS-10	622-4561-00	ROCKWELL COLLINS	UNIVERSAL ATR BREAKOUT BOX
SDU-906	ASI-745-3	NMN	830-3834-001	ROCKWELL COLLINS	POWER SUPPLY TEST SET
SDU-906	ASI-746-2	NMN	676-7387-003	ROCKWELL COLLINS	RAM BUFFER CARD
SDU-906	ASI-747	NMN	676-7385-001	ROCKWELL COLLINS	BUS BUFFER CARD
SDU-906	ASI-749	NMN	830-1228-001	ROCKWELL COLLINS	SYSTEM PROCESSOR TEST SET
SDU-906	ASI-751	NMN	830-1630-001	ROCKWELL COLLINS	MAIN UNIT TEST SET (REQ ASI-755/756/757)
SMT-1001	ASI-212-5	960M-3	622-2741-001	ROCKWELL COLLINS	SERVO TORQUE TESTER

ASI TEST EQUIPMENT UNIT UNDER TEST (UUT) CROSS REFERENCE

UNIT TESTED	ASI MN	EQUIV MN	EQUIV PN	EQUIV OEM	DESCRIPTION
SMT-1001	ASI-348-2	NMN	NPN	ROCKWELL COLLINS	SERVO TEST PANEL
SMT-65	ASI-18-9B	NMN	634-2835-001	ROCKWELL COLLINS	CAPSTAN HOLDING FIXTURE
SMT-65E	ASI-18-9C	NMN	634-2830-001	ROCKWELL COLLINS	CAPSTAN HOLDING FIXTURE
SMT-65	ASI-212-5	960M-3	622-2741-001	ROCKWELL COLLINS	SERVO TORQUE TESTER
SMT-65	ASI-246-2	NMN	621-1985-002	ROCKWELL COLLINS	CAPSTAN TEST FIXTURE
SMT-65	ASI-348-1	NMN	NPN	ROCKWELL COLLINS	SVO-65 OPTIONAL TEST PANEL
SMT-85	ASI-246-3	997T-1	822-0030-001	ROCKWELL COLLINS	SERVO MOUNT TEST ADAPTER
SMT-86	ASI-246-3	997T-1	822-0030-001	ROCKWELL COLLINS	SERVO MOUNT TEST ADAPTER
SMT-87	ASI-246-3	997T-1	822-0030-001	ROCKWELL COLLINS	SERVO MOUNT TEST ADAPTER
SVO-1000	ASI-158	NMN	637-7656-001	ROCKWELL COLLINS	UNIVERSAL HIGH POT TESTER
SVO-1000	ASI-15-8A	NMN	687-9993-001	ROCKWELL COLLINS	CABLE: ASI-158 TO SVO-1000
SVO-1000	ASI-212-4	960M-4	622-5434-001	ROCKWELL COLLINS	TORQUE TESTER
SVO-1000	ASI-403-2	972S-5	622-7122-002	ROCKWELL COLLINS	PRIMARY SERVO TEST PANEL
SVO-3000	ASI-212-4	960M-4	622-5434-001	ROCKWELL COLLINS	TORQUE TESTER
SVO-3000	ASI-403-1	972S-5	622-7122-001	ROCKWELL COLLINS	PRIMARY SERVO TEST PANEL
SVO-65	ASI-212-5	960M-3	622-2741-001	ROCKWELL COLLINS	SERVO TORQUE TESTER
SVO-65	ASI-246-2	NMN	621-9185-002	ROCKWELL COLLINS	CAPSTAN TEST FIXTURE
SVO-65	ASI-348-1	NMN	NPN	ROCKWELL COLLINS	SVO-65 OPTIONAL TEST PANEL
SVO-75	ASI-212-5	960M-3	622-2741-001	ROCKWELL COLLINS	SERVO TORQUE TESTER
SVO-75	ASI-246-2	NMN	621-9185-002	ROCKWELL COLLINS	CAPSTAN TEST FIXTURE
SVO-75	ASI-403-1	972S-5	622-7122-001	ROCKWELL COLLINS	PRIMARY SERVO TEST PANEL
SVO-80()	ASI-212-1	960M-1	622-0471-001	ROCKWELL COLLINS	TORQUE TESTER
SVO-80()	ASI-213-1	NMN	608-3617-001	ROCKWELL COLLINS	SERVO LOOP TEST SET
SVO-80()	ASI-213-2	NMN	608-0789-001	ROCKWELL COLLINS	MINIMUM PERFORMANCE TEST PANEL
SVO-80()	ASI-40Y-69()	440Y-69A	622-4088-001	ROCKWELL COLLINS	980L-1 PLUG-IN ADAPTER
SVO-830()	ASI-212-3	960M-3	622-2741-001	ROCKWELL COLLINS	SERVO TORQUE TESTER
SVO-830()	ASI-431	972S-4	622-3211-001	ROCKWELL COLLINS	SERVO TEST PANEL
SVO-85()	ASI-212-4	960M-4	622-5434-001	ROCKWELL COLLINS	TORQUE TESTER
SVO-85()	ASI-403-1	972S-5	622-7122-001	ROCKWELL COLLINS	PRIMARY SERVO TEST PANEL
SVT-1000	ASI-21-24A	NMN	634-1773-001	ROCKWELL COLLINS	CAPSTAN TORQUE ADJUSTMENT FIXTURE
SVT-1000	ASI-21-24B	NMN	634-1773-002	ROCKWELL COLLINS	CAPSTAN TORQUE ADJUSTMENT FIXTURE
SVT-1000	ASI-21-24C	NMN	634-1723-001	ROCKWELL COLLINS	CAPSTAN ADJUSTMENT WRENCH (P/O ASI-21-24A)
SVT-1000()	ASI-212-5	960M-5	622-6454-001	ROCKWELL COLLINS	TORQUE TESTER
SVT-1000()	ASI-249	NMN	676-1949-001	ROCKWELL COLLINS	TEST PANEL / RUN-IN ASSY
SVT-1000()	ASI-348-2	NMN	NPN	ROCKWELL COLLINS	SERVO TEST PANEL
SYN-1B	ASI-171	RDT-1A	2037736-0501	HONEYWELL (BENDIX)	RDR-1 RADAR SYSTEM TEST PANEL
TARSYN	ASI-260-1	T321703	NPN	HONEYWELL (SPERRY)	TARSYN/G-14 TEST FIXTURE
TARSYN	ASI-407-1	T307702-4	NPN	HONEYWELL (SPERRY)	POWER SUPPLY AND READOUT FIXTURE
TARSYN	ASI-407-2	T321272-901	NPN	HONEYWELL (SPERRY)	API LATCHING FIXTURE
TARSYN-H	ASI-411-2	T322880	NPN	HONEYWELL (SPERRY)	TARSYN-H BASE TEST FIXTURE
TCN-40	ASI-120	NMN	NPN	ROCKWELL COLLINS	TCN-40 TEST PANEL
TCR-200	ASI-338-3	CTS-202	622-4283-001	ROCKWELL COLLINS	TRANSCEIVER-PA TEST PANEL
TCR-220	ASI-338-3	CTS-202	622-4283-001	ROCKWELL COLLINS	TRANSCEIVER-PA TEST PANEL
TCR-451	ASI-257	CTS-451	622-3882-001	ROCKWELL COLLINS	DME-451 TEST SET
TDR-230	ASI-338-3	CTS-202	622-4283-001	ROCKWELL COLLINS	TRANSCEIVER-PA TEST PANEL
TDR-90	ASI-130	NMN	NPN	ROCKWELL COLLINS	PRO LINE TRANSPONDER TEST PANEL
TDR-90	ASI-200-14	NMN	NPN	ROCKWELL COLLINS	ASI-2000 PLUG-IN ADAPTER
TDR-90	ASI-CTS-10	CTS-10	622-4561-00	ROCKWELL COLLINS	UNIVERSAL ATR BREAKOUT BOX
TDR-94/94D	ASI-214	NMN	NPN	ROCKWELL COLLINS	FLIGHT LINE TEST PANEL
TDR-94/94D	ASI-CTS-10	CTS-10	622-4561-00	ROCKWELL COLLINS	UNIVERSAL ATR BREAKOUT BOX
TDR-94/94D	ASI-CTS-940	CTS-940	628-8750-001	ROCKWELL COLLINS	MODE S TRANSPONDER TEST SET
TDR-94/94D	ASI-CTS-941R	NMN	NPN	ROCKWELL COLLINS	MODE S TRANSPONDER TEST SET
TPR-710A	ASI-708	NMN	NPN	ROCKWELL COLLINS	SUPPRESSOR LOAD BOX
TPR-710A	ASI-709	NMN	NPN	ROCKWELL COLLINS	RECEIVER EXTENDER CABLE
TPR-710A	ASI-710	NMN	NPN	ROCKWELL COLLINS	COAX EXTENDER CABLE
TR-421A	ASI-810-3	92XD-1	01-0218-00	HONEYWELL (BENDIX/KING)	SERIES III / FLITELINE DME/XPDR SYSTEM TEST PANEL
TR-421B	ASI-810-3	92XD-1	01-0218-00	HONEYWELL (BENDIX/KING)	SERIES III / FLITELINE DME/XPDR SYSTEM TEST PANEL
TRS-42A	ASI-810-3	92XD-1	01-0218-00	HONEYWELL (BENDIX/KING)	DMS-44A/TRS-44A SYSTEM TEST PANEL
TSM-1000	ASI-212-5	960M-3	622-2741-001	ROCKWELL COLLINS	SERVO TORQUE TESTER
TSM-1000	ASI-348-2	NMN	NPN	ROCKWELL COLLINS	SERVO TEST PANEL
TSM-1001	ASI-212-5	960M-3	622-2741-001	ROCKWELL COLLINS	SERVO TORQUE TESTER
TSM-1001	ASI-348-2	NMN	NPN	ROCKWELL COLLINS	SERVO TEST PANEL
TWR-850	ASI-CTS-841	CTS-841	822-0081-001	ROCKWELL COLLINS	RTA TEST PANEL
VC-401A	ASI-810-2	92CN-1	01-0217-00	HONEYWELL (BENDIX/KING)	SERIES III / FLITELINE COM/NAV SYSTEM TEST PANEL
VC-401B	ASI-810-2	92CN-1	01-0217-00	HONEYWELL (BENDIX/KING)	SERIES III / FLITELINE COM/NAV SYSTEM TEST PANEL
VC-401C	ASI-810-2	92CN-1	01-0217-00	HONEYWELL (BENDIX/KING)	SERIES III / FLITELINE COM/NAV SYSTEM TEST PANEL
VCC-186	ASI-2389-002	NMN	638-2389-002	ROCKWELL COLLINS	INTERCONNECT CABLE SET
VCC-186	ASI-2390-001	NMN	638-2390-001	ROCKWELL COLLINS	INTERCONNECT CABLE SET
VCN-186	ASI-2389-002	NMN	638-2389-002	ROCKWELL COLLINS	INTERCONNECT CABLE SET
VCN-186	ASI-4015-186	NMN	647-4015-001	ROCKWELL COLLINS	INTERCONNECT CABLE SET
VCN-186	ASI-6787-001	CTS-90	622-6787-001	ROCKWELL COLLINS	INTERCONNECT CABLE SET
VCS-40A	ASI-810-2	92CN-1	01-0217-00	HONEYWELL (BENDIX/KING)	SERIES III / FLITELINE COM/NAV SYSTEM TEST PANEL
VCS-40C	ASI-810-2	92CN-1	01-0217-00	HONEYWELL (BENDIX/KING)	SERIES III / FLITELINE COM/NAV SYSTEM TEST PANEL
VCT-186()	ASI-2389-002	NMN	638-2389-002	ROCKWELL COLLINS	INTERCONNECT CABLE SET
VCT-186()	ASI-2390-001	NMN	638-2390-001	ROCKWELL COLLINS	INTERCONNECT CABLE SET

ASI TEST EQUIPMENT UNIT UNDER TEST (UUT) CROSS REFERENCE

UNIT TESTED	ASI MN	EQUIV MN	EQUIV PN	EQUIV OEM	DESCRIPTION
VCT-186()	ASI-4015-186	NMN	647-4015-001	ROCKWELL COLLINS	INTERCONNECT CABLE SET
VG-14/14A/14H	ASI-260-1	T321703	NPN	HONEYWELL (SPERRY)	TARSYN/VG-14 TEST FIXTURE
VG-14/14A/14H	ASI-407-2	T321272-901	NPN	HONEYWELL (SPERRY)	API LATCHING FIXTURE
VG-14H	ASI-411-2	T322880	NPN	HONEYWELL (SPERRY)	VG-14H BASE TEST FIXTURE
VG-204()	ASI-253	NMN	NPN	L3 (JET)	GYRO TEST PANEL
VG-206()	ASI-253	NMN	NPN	L3 (JET)	GYRO TEST PANEL
VG-208	ASI-253	NMN	NPN	L3 (JET)	GYRO TEST PANEL
VG-401	ASI-260-1	T321703	NPN	HONEYWELL (SPERRY)	TARSYN/VG-14 TEST FIXTURE
VG-401	ASI-407-2	T321272-901	NPN	HONEYWELL (SPERRY)	API LATCHING FIXTURE
VG-401	ASI-411-1	T322695	NPN	HONEYWELL (SPERRY)	VG-401 TEST FIXTURE
VHF-186	ASI-2389-002	NMN	638-2389-002	ROCKWELL COLLINS	INTERCONNECT CABLE SET
VHF-186	ASI-2390-001	NMN	638-2390-001	ROCKWELL COLLINS	INTERCONNECT CABLE SET
VHF-186	ASI-4015-186	NMN	647-4015-001	ROCKWELL COLLINS	INTERCONNECT CABLE SET
VHF-186	ASI-6787-001	CTS-90	622-6787-001	ROCKWELL COLLINS	INTERCONNECT CABLE SET
VHF-20-/20A/-20B	ASI-200-3	NMN	NPN	ROCKWELL COLLINS	ASI-2000 PLUG-IN ADAPTER
VHF-20-/20A/-20B	ASI-217	NMN	NPN	ROCKWELL COLLINS	VHF-20() / VHF-21() TEST PANEL
VHF-21/A/B/C/D	ASI-125	NMN	NPN	ROCKWELL COLLINS	PRO LINE COM TEST PANEL
VHF-21/A/B/C/D	ASI-200-3	NMN	NPN	ROCKWELL COLLINS	ASI-2000 PLUG-IN ADAPTER
VHF-21/A/B/C/D	ASI-217	NMN	NPN	ROCKWELL COLLINS	VHF-20() / VHF-21() TEST PANEL
VHF-22	ASI-125	NMN	NPN	ROCKWELL COLLINS	PRO LINE COM TEST PANEL
VHF-22	ASI-200-3	NMN	NPN	ROCKWELL COLLINS	ASI-2000 PLUG-IN ADAPTER
VHF-422	ASI-125	NMN	NPN	ROCKWELL COLLINS	PRO LINE COM TEST PANEL
VHF-422	ASI-200-11	NMN	NPN	ROCKWELL COLLINS	ASI-2000 PLUG-IN ADAPTER
VHF-700	ASI-700-4	NMN	NPN	ROCKWELL COLLINS	HF/VHF DISCRETE FUNCTION INTERFACE PANEL
VHF-700A	ASI-700-4	NMN	NPN	ROCKWELL COLLINS	HF/VHF DISCRETE FUNCTION INTERFACE PANEL
VHF-700B	ASI-700-4	NMN	NPN	ROCKWELL COLLINS	HF/VHF DISCRETE FUNCTION INTERFACE PANEL
VHF-900	ASI-700-4	NMN	NPN	ROCKWELL COLLINS	HF/VHF DISCRETE FUNCTION INTERFACE PANEL
VHF-900B	ASI-700-4	NMN	NPN	ROCKWELL COLLINS	HF/VHF DISCRETE FUNCTION INTERFACE PANEL
VHF-920	ASI-700-4	NMN	NPN	ROCKWELL COLLINS	HF/VHF DISCRETE FUNCTION INTERFACE PANEL
VIR-130A	ASI-177-2-02	RNT-260A	4000951-6004	HONEYWELL (BENDIX)	VOR/ILS SYSTEM TEST PANEL
VIR-130A/C	ASI-376-1	966Y-2	622-6926-001	ROCKWELL COLLINS	VOR/ILS TEST PANEL
VIR-30	ASI-127-1	NMN	NPN	ROCKWELL COLLINS	VIR-30/31/32/33 MANUAL TEST PANEL
VIR-30	ASI-161	479V-3	NPN	ROCKWELL COLLINS	PRECISION TRACK SELECTOR
VIR-30	ASI-200-2()	NMN	NPN	ROCKWELL COLLINS	ASI-2000 PLUG-IN ADAPTER
VIR-31	ASI-127-1	NMN	NPN	ROCKWELL COLLINS	VIR-30/31/32/33 MANUAL TEST PANEL
VIR-31	ASI-161	479V-3	NPN	ROCKWELL COLLINS	PRECISION TRACK SELECTOR
VIR-31	ASI-200-2()	NMN	NPN	ROCKWELL COLLINS	ASI-2000 PLUG-IN ADAPTER
VIR-32	ASI-127-1	NMN	NPN	ROCKWELL COLLINS	VIR-30/31/32/33 MANUAL TEST PANEL
VIR-32	ASI-128	NMN	NPN	ROCKWELL COLLINS	VIR-32/33/432/433 TEST PANEL
VIR-32	ASI-200-2()	NMN	NPN	ROCKWELL COLLINS	ASI-2000 PLUG-IN ADAPTER
VIR-33	ASI-127-1	NMN	NPN	ROCKWELL COLLINS	VIR-30/31/32/33 MANUAL TEST PANEL
VIR-33	ASI-128	NMN	NPN	ROCKWELL COLLINS	VIR-32/33/432/433 TEST PANEL
VIR-33	ASI-200-2()	NMN	NPN	ROCKWELL COLLINS	ASI-2000 PLUG-IN ADAPTER
VIR-432	ASI-128	NMN	NPN	ROCKWELL COLLINS	VIR-32/33/432/433 TEST PANEL
VIR-432	ASI-200-12	NMN	NPN	ROCKWELL COLLINS	ASI-2000 PLUG-IN ADAPTER
VIR-433	ASI-128	NMN	NPN	ROCKWELL COLLINS	VIR-32/33/432/433 TEST PANEL
VIR-433	ASI-200-12	NMN	NPN	ROCKWELL COLLINS	ASI-2000 PLUG-IN ADAPTER
VN-411A	ASI-810-2	92CN-1	01-0217-00	HONEYWELL (BENDIX/KING)	SERIES III / FLITELINE COM/NAV SYSTEM TEST PANEL
VN-411B	ASI-810-2	92CN-1	01-0217-00	HONEYWELL (BENDIX/KING)	SERIES III / FLITELINE COM/NAV SYSTEM TEST PANEL
VNS-41A	ASI-810-2	92CN-1	01-0217-00	HONEYWELL (BENDIX/KING)	SERIES III / FLITELINE COM/NAV SYSTEM TEST PANEL
VOR-700	ASI-700-2	NMN	NPN	ROCKWELL COLLINS	ADF/GLU/ILS/VOR D.F.I.U.
VOR-700A	ASI-700-2	NMN	NPN	ROCKWELL COLLINS	ADF/GLU/ILS/VOR D.F.I.U.
VOR-900	ASI-700-2	NMN	NPN	ROCKWELL COLLINS	ADF/GLU/ILS/VOR D.F.I.U.
VSI-80()	ASI-415-1	970D-1A	622-5811-001	ROCKWELL COLLINS	ADS AIR DATA TEST PANEL
WA-700	ASI-266-2	HWX-700	7015455-901	HONEYWELL (BENDIX/KING)	PRIMUS 700/701 RADAR SYSTEM TEST PANEL
WA-700	ASI-266-2A	HWX-700A	T337333	HONEYWELL (BENDIX/KING)	PRIMUS 700/700A/701/701A RADAR SYSTEM TESTER
WA-800	ASI-266	NMN	T334614	HONEYWELL (BENDIX/KING)	PRIMUS-800 TEST PANEL
WC-440	ASI-263-2	HWX-660/880	T336162	HONEYWELL (BENDIX/KING)	PRIMUS 331/440/660/880 RADAR SYSTEM TEST SET
WC-650	ASI-263	NMN	T334612	HONEYWELL (BENDIX/KING)	PRIMUS-450/650/870 TEST PANEL
WC-650	ASI-265	NMN	NPN	HONEYWELL (BENDIX/KING)	BUS MONITOR
WC-660	ASI-263-2	HWX-660/880	T336162	HONEYWELL (BENDIX/KING)	PRIMUS 331/440/660/880 RADAR SYSTEM TEST SET
WC-700/701	ASI-266-2	HWX-700	7015455-901	HONEYWELL (BENDIX/KING)	PRIMUS 700/701 RADAR SYSTEM TEST PANEL
WC-700/701	ASI-266-2A	HWX-700A	T337333	HONEYWELL (BENDIX/KING)	PRIMUS 700/700A/701/701A RADAR SYSTEM TESTER
WC-800	ASI-265	NMN	NPN	ROCKWELL COLLINS	BUS MONITOR
WC-800	ASI-266	NMN	T334614	HONEYWELL (BENDIX/KING)	PRIMUS-800 TEST PANEL
WC-810	ASI-265	NMN	NPN	HONEYWELL (BENDIX/KING)	BUS MONITOR
WC-810	ASI-266	NMN	T334614	HONEYWELL (BENDIX/KING)	PRIMUS-800 TEST PANEL
WC-870	ASI-263	NMN	T334612	HONEYWELL (BENDIX/KING)	PRIMUS-450/650/870 TEST PANEL
WC-870	ASI-265	NMN	NPN	HONEYWELL (BENDIX/KING)	BUS MONITOR
WC-874	ASI-263	NMN	NPN	HONEYWELL (BENDIX/KING)	PRIMUS-450/650/870 TEST PANEL
WC-874	ASI-264	T334612	NPN	HONEYWELL (BENDIX/KING)	EFIS AUX CONN TEST BOX
WC-874	ASI-265	NMN	NPN	HONEYWELL (BENDIX/KING)	BUS MONITOR
WC-880	ASI-263-2	HWX-660/880	T336162	HONEYWELL (BENDIX/KING)	PRIMUS 331/440/660/880 RADAR SYSTEM TEST SET
WCP-701	ASI-738	WJB-701	622-5760-001	ROCKWELL COLLINS	WXR-700X J-BOX
WCP-701	ASI-764	NMN	NPN	ROCKWELL COLLINS	TEST FIXTURE

ASI TEST EQUIPMENT UNIT UNDER TEST (UUT) CROSS REFERENCE

UNIT TESTED	ASI MN	EQUIV MN	EQUIV PN	EQUIV OEM	DESCRIPTION
WCP-702	ASI-738	WJB-701	622-5760-001	ROCKWELL COLLINS	WXR-700X J-BOX
WCP-702	ASI-764	NMN	NPN	ROCKWELL COLLINS	TEST FIXTURE
WI-440	ASI-155	NMN	7010569-901	HONEYWELL (BENDIX/KING)	UNIVERSAL DIGITAL INTERFACE TEST SET
WI-440	ASI-263-2	HWX-660/880	T336162	HONEYWELL (BENDIX/KING)	PRIMUS 331/440/660/880 RADAR SYSTEM TEST SET
WI-450	ASI-155	NMN	7010569-901	HONEYWELL (BENDIX/KING)	UNIVERSAL DIGITAL INTERFACE TEST SET
WI-450	ASI-263	NMN	T334612	HONEYWELL (BENDIX/KING)	PRIMUS-450/650/870 TEST PANEL
WI-450	ASI-265	NMN	NPN	HONEYWELL (BENDIX/KING)	BUS MONITOR
WI-450	ASI-268	NMN	NPN	HONEYWELL (BENDIX/KING)	TARGET SIMULATOR
WI-650	ASI-155	NMN	7010569-901	HONEYWELL (BENDIX/KING)	UNIVERSAL DIGITAL INTERFACE TEST SET
WI-650	ASI-263	NMN	T334612	HONEYWELL (BENDIX/KING)	PRIMUS-450/650/870 TEST PANEL
WI-650	ASI-265	NMN	NPN	HONEYWELL (BENDIX/KING)	BUS MONITOR
WI-650	ASI-268	NMN	NPN	HONEYWELL (BENDIX/KING)	TARGET SIMULATOR
WI-660	ASI-155	NMN	7010569-901	HONEYWELL (BENDIX/KING)	UNIVERSAL DIGITAL INTERFACE TEST SET
WI-660	ASI-263-2	HWX-660/880	T336162	HONEYWELL (BENDIX/KING)	PRIMUS 331/440/660/880 RADAR SYSTEM TEST SET
WI-700	ASI-266-2	HWX-700	7015455-901	HONEYWELL (BENDIX/KING)	PRIMUS 700/701 RADAR SYSTEM TEST PANEL
WI-700	ASI-266-2A	HWX-700A	T337333	HONEYWELL (BENDIX/KING)	PRIMUS 700/700A/701/701A RADAR SYSTEM TESTER
WI-800	ASI-155	NMN	7010569-901	HONEYWELL (BENDIX/KING)	UNIVERSAL DIGITAL INTERFACE TEST SET
WI-800	ASI-266	NMN	T334614	HONEYWELL (BENDIX/KING)	PRIMUS-800 TEST PANEL
WI-870	ASI-155	NMN	7010569-901	HONEYWELL (BENDIX/KING)	UNIVERSAL DIGITAL INTERFACE TEST SET
WI-870	ASI-263	NMN	T334612	HONEYWELL (BENDIX/KING)	PRIMUS-450/650/870 TEST PANEL
WI-870	ASI-265	NMN	NPN	HONEYWELL (BENDIX/KING)	BUS MONITOR
WI-870	ASI-268	NMN	NPN	HONEYWELL (BENDIX/KING)	TARGET SIMULATOR
WI-880	ASI-263-2	HWX-660/880	T336162	HONEYWELL (BENDIX/KING)	PRIMUS 331/440/660/880 RADAR SYSTEM TEST SET
WMA-701X/702X	ASI-3831-001	NMN	830-3831-001	ROCKWELL COLLINS	AIRBORNE GEAR SHIMMING KIT
WMA-701X/702X	ASI-725	NMN	NPN	ROCKWELL COLLINS	LEVELING BASE
WMA-701X/702X	ASI-726	NMN	647-1997-001	ROCKWELL COLLINS	MOTOR DRIVER TEST FIXTURE
WMA-701X/702X	ASI-728	NMN	NPN	ROCKWELL COLLINS	ANTENNA WEIGHT SIMULATOR
WMA-701X/702X	ASI-729	NMN	647-0283-001	ROCKWELL COLLINS	POWER SUPPLY TEST FIXTURE
WMA-701X/702X	ASI-731	NMN	NPN	ROCKWELL COLLINS	MOTOR DRIVER TEST FIXTURE
WMA-701X/702X	ASI-732	NMN	NPN	ROCKWELL COLLINS	RCVR/MONITOR DRVR TEST FIXTURE
WMA-701X/702X	ASI-733	NMN	NPN	ROCKWELL COLLINS	PRELOAD SPRING TORQUE ADAPTER
WMA-701X/702X	ASI-734	NMN	NPN	ROCKWELL COLLINS	ZERO MON A5 AND A6 MOUNT JIG
WMA-701X/702X	ASI-735	NMN	NPN	ROCKWELL COLLINS	ZERO MON A5 ABD A6 MOUNT PROBE
WMA-701X/702X	ASI-736	NMN	NPN	ROCKWELL COLLINS	COIL SPRING TORQUE ADAPTER
WMA-701X/702X	ASI-737	NMN	NPN	ROCKWELL COLLINS	WAVEGUIDE FLANGE
WMA-701X/702X	ASI-738	WJB-701	622-5760-001	ROCKWELL COLLINS	WXR-700X J-BOX
WR-700	ASI-266-2	HWX-700	7015455-901	HONEYWELL (BENDIX/KING)	PRIMUS 700/701 RADAR SYSTEM TEST PANEL
WR-700A	ASI-266-2A	HWX-700A	T337333	HONEYWELL (BENDIX/KING)	PRIMUS 700/700A/701/701A RADAR SYSTEM TESTER
WR-701	ASI-266-2	HWX-700	7015455-901	HONEYWELL (BENDIX/KING)	PRIMUS 700/701 RADAR SYSTEM TEST PANEL
WR-701A	ASI-266-2A	HWX-700A	T337333	HONEYWELL (BENDIX/KING)	PRIMUS 700/700A/701/701A RADAR SYSTEM TESTER
WR-800	ASI-265	NMN	NPN	ROCKWELL COLLINS	BUS MONITOR
WR-800	ASI-266	NMN	T334614	ROCKWELL COLLINS	PRIMUS-800 TEST PANEL
WR-800	ASI-267	NMN	70110568	ROCKWELL COLLINS	GYRO SIMULATOR
WRT-701X	ASI-7000-701X	NMN	NPN	ROCKWELL COLLINS	CPU BOARD ANALYZER
WRT-701X	ASI-723	MST-902	622-6101-001	ROCKWELL COLLINS	MICROPROCESSOR TEST ADAPTER
WRT-701X	ASI-724	NMN	NPN	ROCKWELL COLLINS	TEST BREAKOUT BOX
WRT-701X	ASI-738	WJB-701	622-5760-001	ROCKWELL COLLINS	WXR-700X J-BOX
WRT-701X	ASI-739	NMN	NPN	ROCKWELL COLLINS	TURBULANCE TEST CONTROLLER
WRT-701X	ASI-7994-701X	NMN	659-7994-002	ROCKWELL COLLINS	WRT-701X MAINTENANCE KIT (X-BAND)
WRT-701X (FLW)	ASI-488	TS-488A/UP	279-0176-010	ROCKWELL COLLINS	ECHO BOX TEST PANEL
WRT-701X (FLW)	ASI-6960-001	NMN	830-6960-001	ROCKWELL COLLINS	FLW ALIGNMENT KIT
WRT-701X (FLW)	ASI-738	WJB-701	622-5760-001	ROCKWELL COLLINS	WXR-700X J-BOX
WU-331	ASI-263-2	HWX-660/880	T336162	HONEYWELL (BENDIX/KING)	PRIMUS 331/440/660/880 RADAR SYSTEM TEST SET
WU-440	ASI-263-2	HWX-660/880	T336162	HONEYWELL (BENDIX/KING)	PRIMUS 331/440/660/880 RADAR SYSTEM TEST SET
WU-450	ASI-263	NMN	T334612	HONEYWELL (BENDIX/KING)	PRIMUS-450/650/870 TEST PANEL
WU-450	ASI-265	NMN	NPN	HONEYWELL (BENDIX/KING)	BUS MONITOR
WU-450	ASI-267	NMN	70110568	ROCKWELL COLLINS	GYRO SIMULATOR
WU-450	ASI-268	NMN	NPN	HONEYWELL (BENDIX/KING)	TARGET SIMULATOR
WU-650	ASI-263	NMN	T334612	HONEYWELL (BENDIX/KING)	PRIMUS-450/650/870 TEST PANEL
WU-650	ASI-265	NMN	NPN	HONEYWELL (BENDIX/KING)	BUS MONITOR
WU-650	ASI-267	NMN	70110568	ROCKWELL COLLINS	GYRO SIMULATOR
WU-650	ASI-268	NMN	NPN	HONEYWELL (BENDIX/KING)	TARGET SIMULATOR
WU-660	ASI-263-2	HWX-660/880	T336162	HONEYWELL (BENDIX/KING)	PRIMUS 331/440/660/880 RADAR SYSTEM TEST SET
WU-870	ASI-263	NMN	T334612	HONEYWELL (BENDIX/KING)	PRIMUS-450/650/870 TEST PANEL
WU-870	ASI-265	NMN	NPN	HONEYWELL (BENDIX/KING)	BUS MONITOR
WU-870	ASI-267	NMN	70110568	ROCKWELL COLLINS	GYRO SIMULATOR
WU-870	ASI-268	NMN	NPN	HONEYWELL (BENDIX/KING)	TARGET SIMULATOR
WU-880	ASI-263-2	HWX-660/880	T336162	HONEYWELL (BENDIX/KING)	PRIMUS 331/440/660/880 RADAR SYSTEM TEST SET
WXA-85	ASI-188-1	NMN	NPN	ROCKWELL COLLINS	WXR DIGITAL WEATHER RADAR TEST PANEL
WXI-701	ASI-738	WJB-701	622-5760-001	ROCKWELL COLLINS	WXR-700X J-BOX
WXI-711	ASI-727	NMN	NPN	ROCKWELL COLLINS	FRONT PANEL EXTENDER CABLE
WXI-711	ASI-730-1	NMN	NPN	ROCKWELL COLLINS	REAR CONNECTOR BREAKOUT BOX
WXI-711	ASI-730-2	NMN	NPN	ROCKWELL COLLINS	TCAS BREAKOUT BOX
WXI-711	ASI-738	WJB-701	622-5760-001	ROCKWELL COLLINS	WXR-700X J-BOX
WXI-711A	ASI-269	NMN	NPN	ROCKWELL COLLINS	TWR-850 BASE TEST PANEL

ASI TEST EQUIPMENT UNIT UNDER TEST (UUT) CROSS REFERENCE

UNIT TESTED	ASI MN	EQUIV MN	EQUIV PN	EQUIV OEM	DESCRIPTION
WXP-840A	ASI-269	NMN	NPN	ROCKWELL COLLINS	TWR-850 BASE TEST PANEL
WXP-840B	ASI-269	NMN	NPN	ROCKWELL COLLINS	TWR-850 BASE TEST PANEL
WXP-850A	ASI-269	NMN	NPN	ROCKWELL COLLINS	TWR-850 BASE TEST PANEL
WXP-850B	ASI-269	NMN	NPN	ROCKWELL COLLINS	TWR-850 BASE TEST PANEL
WXP-85A	ASI-188-1	NMN	NPN	ROCKWELL COLLINS	WXR DIGITAL WEATHER RADAR TEST PANEL
WXP-85B	ASI-188-1	NMN	NPN	ROCKWELL COLLINS	WXR DIGITAL WEATHER RADAR TEST PANEL
WXP-85C	ASI-188-1	NMN	NPN	ROCKWELL COLLINS	WXR DIGITAL WEATHER RADAR TEST PANEL
WXP-85D	ASI-188-1	NMN	NPN	ROCKWELL COLLINS	WXR DIGITAL WEATHER RADAR TEST PANEL
WXR-150	ASI-188-1	NMN	NPN	ROCKWELL COLLINS	WXR DIGITAL WEATHER RADAR TEST PANEL
WXR-200	ASI-188-1	NMN	NPN	ROCKWELL COLLINS	WXR DIGITAL WEATHER RADAR TEST PANEL
WXR-200A	ASI-188-1	NMN	NPN	ROCKWELL COLLINS	WXR DIGITAL WEATHER RADAR TEST PANEL
WXR-220	ASI-188-1	NMN	NPN	ROCKWELL COLLINS	WXR DIGITAL WEATHER RADAR TEST PANEL
WXR-250A	ASI-188-1	NMN	NPN	ROCKWELL COLLINS	WXR DIGITAL WEATHER RADAR TEST PANEL
WXR-250B	ASI-188-1	NMN	NPN	ROCKWELL COLLINS	WXR DIGITAL WEATHER RADAR TEST PANEL
WXR-270	ASI-188-1	NMN	NPN	ROCKWELL COLLINS	WXR DIGITAL WEATHER RADAR TEST PANEL
WXR-300	ASI-188-1	NMN	NPN	ROCKWELL COLLINS	WXR DIGITAL WEATHER RADAR TEST PANEL
WXR-350	ASI-188-1	NMN	NPN	ROCKWELL COLLINS	WXR DIGITAL WEATHER RADAR TEST PANEL
WXR-700C	ASI-7994-701C	NMN	659-7994-001	ROCKWELL COLLINS	WRT-701C MAINTENANCE KIT (C-BAND)
WXR-700X	ASI-722	WMT-701X	646-4443-009	ROCKWELL COLLINS	TEST RACK
WXR-700X	ASI-723	MST-904	622-6101-001	ROCKWELL COLLINS	MICROPROCESSOR TEST ADAPTER
WXR-700X	ASI-724	NMN	NPN	ROCKWELL COLLINS	TEST BREAKOUT PANEL
WXR-700X	ASI-738	WJB-701	NPN	ROCKWELL COLLINS	J-BOX
WXR-800	ASI-CTS-841	CTS-841	822-0081-001	ROCKWELL COLLINS	RTA TEST PANEL
WXR-840	ASI-CTS-841	CTS-841	822-0081-001	ROCKWELL COLLINS	RTA TEST PANEL
WXT-150	ASI-188-1	NMN	NPN	ROCKWELL COLLINS	WXR DIGITAL WEATHER RADAR TEST PANEL
WXT-200	ASI-188-1	NMN	NPN	ROCKWELL COLLINS	WXR DIGITAL WEATHER RADAR TEST PANEL
WXT-200A	ASI-188-1	NMN	NPN	ROCKWELL COLLINS	WXR DIGITAL WEATHER RADAR TEST PANEL
WXT-250A	ASI-188-1	NMN	NPN	ROCKWELL COLLINS	WXR DIGITAL WEATHER RADAR TEST PANEL
WXT-250A	ASI-188-1	NMN	NPN	ROCKWELL COLLINS	WXR DIGITAL WEATHER RADAR TEST PANEL
WXT-250B	ASI-188-1	NMN	NPN	ROCKWELL COLLINS	WXR DIGITAL WEATHER RADAR TEST PANEL
WXT-250B	ASI-188-1	NMN	NPN	ROCKWELL COLLINS	WXR DIGITAL WEATHER RADAR TEST PANEL

Universal ATR Breakout Extender Cables

ASI-52-1 / ASI-52-2 / ASI-52-3
 ASI-60-1 / ASI-60-2 / ASI-60-3 / ASI-60-4
 ASI-80-1 / ASI-80-2

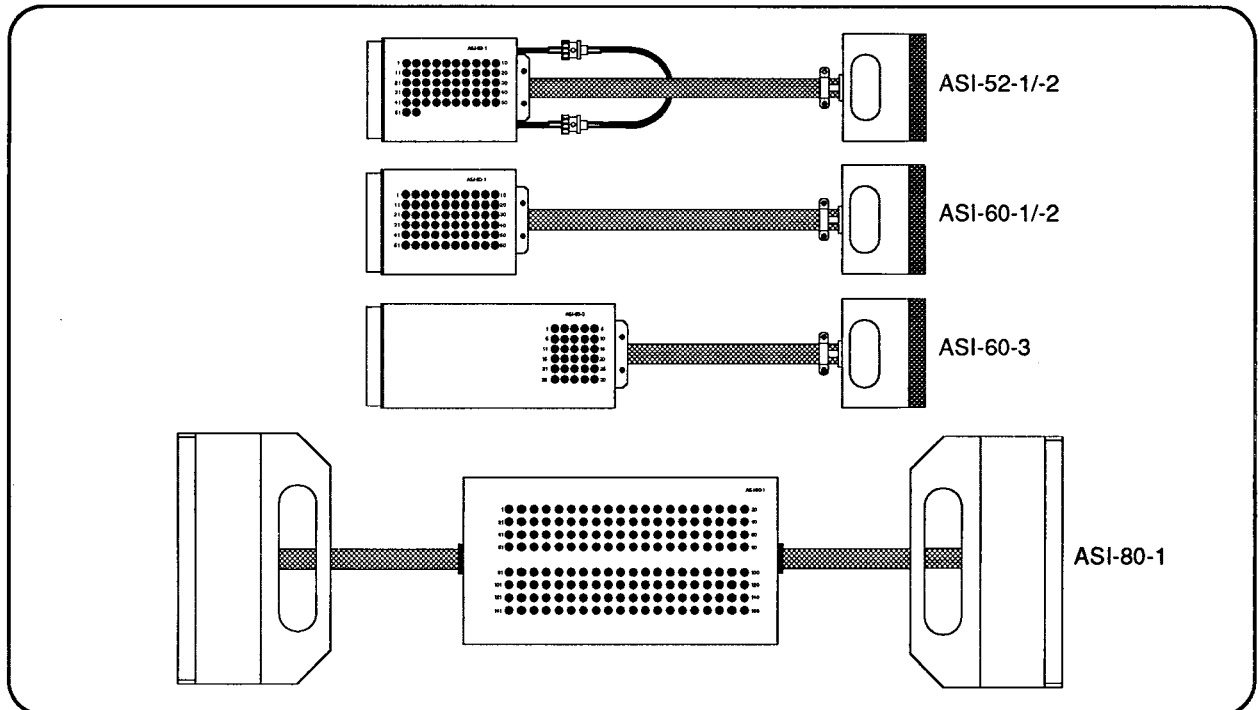

The Universal ATR Breakout Extender Cables provide access to all of the pins on the rear connector of a Collins avionics unit (equipped with a Thinline connector). The LRU can be extended from its rack in the aircraft so that signal checks and monitoring can be performed on each individual wire via the test jacks mounted in the cable chassis. Consult the matrix at the right for ASI-52-1/-2, ASI-60-1/-2/-3, and ASI-80-1 LRU compatibility.

The ASI-52-1/-2 provide access to 52 signal pins (half height Thinline) as well as two RF connections. The cables are 4 feet long and configured in the following fashion:

- ASI-52-1: 52 pin breakout with left side mounted test jacks.
- ASI-52-2: 52 pin breakout with right side mounted test jacks.
- ASI-52-3: 52 pin extender cable (without test jacks).

The ASI-60-1/-2/-3 provide access to 60 rear connector signal pins (half height Thinline). The cables are 4 feet long and configured in the following fashion:

- ASI-60-1: 60 pin breakout with left side mounted test jacks.
- ASI-60-2: 60 pin breakout with right side mounted test jacks.
- ASI-60-3: 60 pin breakout with right and left side mounted test jacks (30 each side).
- ASI-60-4: 60 pin extender cable (without test jacks).

When combined together, the ASI-60-1/-2/-3 will functionally replace the Collins CTS-10.

The ASI-80-1/-2 provide access to 80 rear connector signal pins (full height Thinline).

The cables are 6 feet long and configured in the following fashion:

- ASI-80-1: 80 pin breakout with chassis mounted test jacks.
- ASI-80-2: 80 pin extender cable (without test jacks).

Three ASI-80-1's used in unision will functionally replace the Collins CTS-9.

The extender cables (ASI-52-3, ASI-60-4, ASI-80-2) can be used in place of a breakout cable when LRU rear connector pin access is not required.

Direct (form, fit, and function) replacements for the Collins CTS-9 / CTS-10 are listed below.

Optional Equipment:

ASI MN	Equivalent MN	Equivalent PN	Description
ASI-CTS-9	CTS-9	622-6720-001	Universal ATR Breakout Box (Full-Height Thinline)
ASI-CTS-10	CTS-10	622-4561-001	Universal ATR Breakout Box (Half-Height Thinline)

LRU MATRIX	ASI-52-1	ASI-52-2	ASI-60-1	ASI-60-2	ASI-60-3	ASI-80-1	ASI-80-2
AAC-85			X	X			
ADC-80			X	X			
ADC-81			X	X			
ADC-82			X	X			
ADC-85			X	X			
ADC-86			X	X			
ADC-85B			X	X	X		
ADF-50	X						
ADF-462	X						
AHC-85			X	X			
ALT-50A			X				
ALT-55B			X				
ALT-4000			X				
APA-80A			X	X			
APA-80C			X	X	X		
APA-80F			X	X			
APA-80G			X	X	X		
APA-80M			X	X	X		
APC-85			X	X	X		
APC-80			X	X	X		
BA-32			X				
BRG-40			X				
DME-40			X				
DME-42			X				
DME-442			X				
DPU-85							2 ea
DPU-86							2 ea
CAD-870G			X				
CHC-80			X	X	X		
FCC-85			X	X	X		2 ea
FCC-86			X	X	X		2 ea
FGC-65			X	X			
FGC-80			X	X	X		
FPA-80			X				
HPU-74			X	X	X		
MPU-85							3 ea
MPU-86							3 ea
RNC-300			X	X	X		
SOD-440			X	X			
TDR-80			X				
TDR-94/94D			X	X			
VHF-22	X						
VHF-422	X						
VIR-30	X	X					
VIR-31	X	X	X				
VIR-32	X	X					
VIR-33	X	X					
VIR-432	X	X					
VIR-433	X	X					
161H-1			X				
590A-3H/J/K			X	X			
590A-3J1/K1			X	X			
866F-2			X				
899P-1			X	X	X		

ADF Antenna Simulator

ASI-61

OEM Equivalent: HTS
 MN: HTS-61
 PN: 2900-00061-000
 Manual:
 Manual Figure:

UUT: ADF-60 / ADF-462 / DFR-206A
 AN/ARN-149(V) / R-2382 / R-2383
 Size: H: 3.5" W: 19.00" D: 7.00"
 Pwr: Provided by UUT

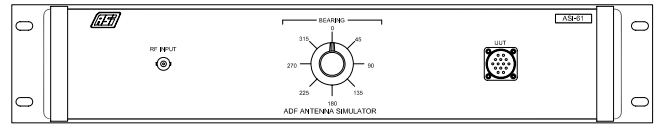

Description:

The ASI-61 ADF Antenna Simulator provides the simulated directional ADF signal required for testing, alignment, and troubleshooting the Collins ADF-60, ADF-462, and DFR-206A ADF Receivers. The ASI-61 works in conjunction with the Collins 970G-1 (ASI-185), 970G-2 (ASI-375-1) or ASI-200-10 / ASI-2000 for complete function testing of the ADF receiver. The optional ASI-18-5D cable is used to interface the ASI-61W to the 970G-1 (ASI-185) or 970G-2 (ASI-375-1).

The ASI-61 is functionally interchangeable with the Collins 970W-1. The ASI-61 is manufactured in a standard 19" wide rack mount chassis. See the ASI-61W For a control head size version of the ASI-61.

Optional Equipment:

ASI MN	OEM PN	Description
ASI-18-5D	NPN	Cable, ASI-185 / ASI-375-() to ASI-61
ASI-200-10	NPN	ADF-60 / ADF-462 Plug-In Adapter
ASI-185	622-2854-001	ADF Test Panel (970G-1)
ASI-375-1	622-7345-001	ADF Test Panel (970G-2)
ASI-0412-001	NPN	ADF Antenna Simulator Test Box

ADF Antenna Simulator

ASI-61W

OEM Equivalent: Rockwell Collins
 MN: 970W-1
 PN: 622-3099-001
 Manual:
 Manual Figure:

UUT: ADF-60 / ADF-462 / DFR-206A
 AN/ARN-149(V) / R-2382 / R-2383
 Size: H: 2.625" W: 5.75" D: 5.00"
 Pwr: Provided by UUT

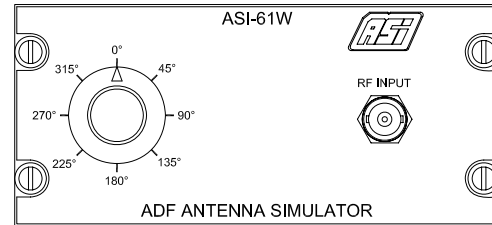

Description:

The ASI-61W ADF Antenna Simulator provides the simulated directional ADF signal required for testing, alignment, and troubleshooting of the Collins ADF-60, ADF-462, and DFR-206A ADF Receivers. The ASI-61W works in conjunction with the Collins 970G-1 (ASI-185), 970G-2 (ASI-375-1) or ASI-200-10 / ASI-2000 for complete function testing of the ADF receiver. The ASI-61W will mount directly into the face plate of the 970G-1 (ASI-185) or the 970G-2 (ASI-375-1).

The ASI-61W is a Form, Fit, and Functional replacement for the Collins 970W-1 / 622-3099-001. See the ASI-61 for a 19" rack mountable version of the ASI-61W.

Optional Equipment:

ASI MN	OEM PN	Description
ASI-200-10	NPN	ADF-60 / ADF-462 Plug-In Adapter
ASI-185	622-2854-001	ADF Test Panel (970G-1)
ASI-375-1	622-7345-001	ADF Test Panel (970G-2)
ASI-0412-001	NPN	ADF Antenna Simulator Test Box

Audio Watt Meter

ASI-83C

OEM Equivalent: HTS
 MN: HTS-83C
 PN: 2900-00083-003
 NSN: 6625-01-444-9555
 EQ NSN: 6625-00-937-6156

UUT: Various
 Size: H: 3.50" W: 19.00" D: 7.00"
 Pwr: 115 VAC 60 Hz

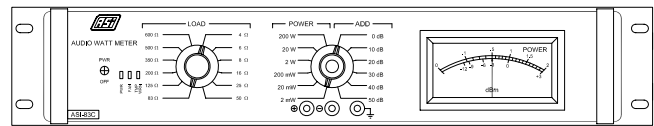

Description:

The ASI-83C Audio Watt Meter is capable of power measurements from the 100 microwatts to 200 watts. The ASI-83C features 12 common impedance loads, and additional non-inductive loading may be coupled for an extended range of impedance matches.

The watt meter has a frequency response from 20 Hz to 20 kHz with no more than a ± 0.5 dB error. The nearly flat power curve across this range is due to the use of non-reactive components within the load bank. Meter scale readings are shown as watts or as dB's referenced to 1 mW (0 dB being the equivalent of 1 mW of power). The power range switch is incremented in 10 dB steps from 0 dB (2 mW full scale) to 50 dB (200 W full scale).

Equipment Supplied:

ASI MN	OEM PN	Description
	4115	Shorting Link (Gnd)

Optional Equipment:

ASI MN	OEM PN	Description
--------	--------	-------------

Solid State Digital Synchro

ASI-110

OEM Equivalent: HTS
 MN: HTS-110
 PN: 2900-00110-000
 Manual:
 Manual Figure:

UUT: Various
 Size: H: 3.40" W: 3.40" D: 6.5"
 Pwr: 26 VAC 400 Hz

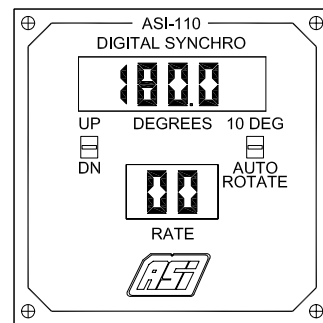

Description:

The ASI-110 Digital Synchro provides precise control over systems requiring ARINC standard synchro sources. The 3-Wire angular output can be set anywhere from 000.0° to 359.9° in either 0.1° or 10° increments. An auto rotation feature allows cycling at rates between 1° to 99° per second or preset at 150° or 300° per second.

The ASI-110 is housed in a standard ARINC ATI style case and is internally protected against short circuits, overloads, and transient voltages.

The ASI-110 is available in two different configurations:

ASI-110-1 Accuracy: ± 0.067° (± 4 min) / Resolution: 0.1° / Load: 7 VA Max
 ASI-110-2 Accuracy: ± 0.033° (± 2 min) / Resolution: 0.1° / Load: 7 VA Max

Equipment Supplied:

ASI MN	OEM PN	Description
--------	--------	-------------

Optional Equipment:

ASI MN	OEM PN	Description
--------	--------	-------------

TCN-40 Test Panel

ASI-120

OEM Equivalent: Rockwell Collins
 MN: NMN
 PN: NPN
 Manual: 523-0766909
 Manual Figure: 2 (Installation Section)

UUT: TCN-40 TACAN System
 DME-40A / BRG-40
 Size: H: 7.00" W: 19.00" D: 7.00"
 Pwr: 28 VDC / 26 VAC 400Hz

Description:
 The ASI-120 Test Panel facilitates testing of the Collins TCN-40 TACAN System consisting of the DME-40A and BRG-40. The ASI-120 duplicates the Special Test Fixture shown in the Collins TCN-40 maintenance manual.

The Test Panel provides proper switching, test points, and interconnection required to test the TCN-40 TACAN System.

Optional cables listed below are required for interconnection and operation of the various system components. An ASI-160B or ASI-160C can be used in place of the compass Simulator, CDI, and RMI.

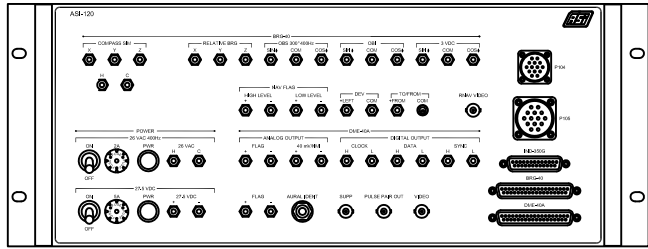

Equipment Supplied:

ASI MN	OEM PN	Description
ASI-12-0A	NPN	Cable, ASI-120 to BRG-40
ASI-12-0B	NPN	Cable, ASI-120 to DME-40A

Optional Equipment:

ASI MN	OEM PN	Description
ASI-12-0C	NPN	Cable, ASI-120 to 332C-10/-10B
ASI-12-0D	NPN	Cable, ASI-120 to IND-350G
ASI-12-0E	NPN	Cable, ASI-120 to 339F-12()
ASI-12-0F	NPN	Cable, ASI-120 to ASI-160B/-160C
ASI-12-0G	NPN	Cable, ASI-120 to 313N-4D / 378N-2
ASI-83C	NPN	Audio Power Meter
ASI-142-1	522-1147-004	Compass Simulator (477L-1)
ASI-160B	NPN	Universal Heading and Track Selector

BIA-32 Test Panel

ASI-121

OEM Equivalent: Rockwell Collins
 MN: NMN
 PN: NPN
 Manual: 523-0775205
 Manual Figure: 5-5 - 5-6

UUT: BIA-32
 Size: H: 5.25" W: 19.00" D: 7.00"
 Pwr: 28 VDC / 26 VAC 400Hz

Description:
 The ASI-121 Test Panel provides interface between the BIA-32 and the data bus simulator required for testing. The ASI-121 duplicates the performance of the BIA-32 Test Panel shown in the Collins maintenance manual. The test panel includes a current meter, test points, and discretes required for testing.

The ASI-121 is supplied with the BIA-32 test cable (ASI-12-1D). Optional RMI cables are available to interface the RMI-30 or RMI-36/BDI-36 to the test panel. The ASI-401-1 is required to interface the ASI-121 to the data bus simulator (PC). The test software required for testing must be purchased direct from Collins to ensure the latest revision level.

See the ASI-2000 and ASI-200-19 catalog pages for alternate test equipment available from ASI for testing the BIA-32.

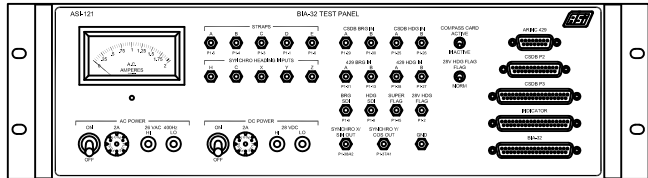

Equipment Supplied:

ASI MN	OEM PN	Description
ASI-12-1D	NPN	Cable, ASI-121 to BIA-32

Test Software:
 523-0777-527 BIA-32 Test Program (PC)

Optional Equipment:

ASI MN	OEM PN	Description
ASI-12-1E	NPN	Cable, ASI-121 to RMI-30
ASI-12-1F	NPN	Cable, ASI-121 to RMI-36 / BDI-36
ASI-165	622-5330-001	Synchro Simulator (CSS-10)
ASI-401-1	NPN	Pro Line PC Interface Panel
CTC-429	822-0854-001	ARINC 429 / CSDB Interface Card (ISA)

DDA-42 Test Panel

ASI-122

OEM Equivalent: Rockwell Collins
 MN: NMN
 PN: NPN
 Manual: 523-0773960
 Manual Figure: 5-4

UUT: DDA-42
 Size: H: 3.50" W: 19.00" D: 7.00"
 Pwr: 28 VDC

Description:
 The ASI-122 Test Panel provides interface between the DDA-42 and the data bus simulator required for testing. The ASI-122 duplicates the performance of the DDA-42 Test Fixture shown in the Collins maintenance manual. The test panel includes all test points, and discretes required for testing.

The ASI-122 is supplied with the DDA-42 test cable (ASI-12-2A). Optional Indicator cables are also available. The ASI-401-1 is required to interface the ASI-122 to the data bus simulator (PC). The test software required for testing must be purchased direct from Collins to ensure the latest revision level.

See the ASI-2000 and ASI-200-15 catalog pages for alternate test equipment available from ASI for testing the DDA-42.

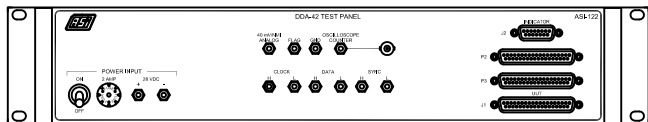

Equipment Supplied:

ASI MN	OEM PN	Description
ASI-12-2A	NPN	Cable, ASI-122 to DDA-42

Test Software:
 523-0777-539 DDA-42 Test Program (PC)

Optional Equipment:

ASI MN	OEM PN	Description
ASI-12-2B	NPN	Cable, ASI-122 to IND-40() / IND-41()
ASI-12-2C	NPN	Cable, ASI-122 to 339F-8B
ASI-12-2D	NPN	Cable, ASI-122 to 339F-12()
ASI-12-2E	NPN	Cable, ASI-122 to 339F-18()
ASI-401-1	NPN	Pro Line PC Interface Panel
CTC-429	822-0854-001	ARINC 429 / CSDB Interface Card (ISA)

BDI-36 Test Panel

ASI-123

OEM Equivalent: Rockwell Collins MN: NMN PN: NPN Manual: 523-0766802 Manual Figure: 5-6	UUT: BDI-36 Size: H: 3.50" W: 19.00" D: 7.00" Pwr: 28 VDC
---	---

Description:
The ASI-123 Test Panel tests the DME portion of the Collins BDI-36 Bearing Distance Indicator. The test panel provides switching, test points, and interconnection between the uut and an ARINC 568 DME data source in order to perform the test procedure outlined in the unit maintenance manual.

The ARINC 568 source can be either a Colt CTS-703 with CTA-339B1 Test adapter (ASI-12-3B) or an ASI-176-1 with an ASI-12-3C1 cable.

For more information on fully testing the BDI-36 and RMI-36 see the ASI-187 catalog page.

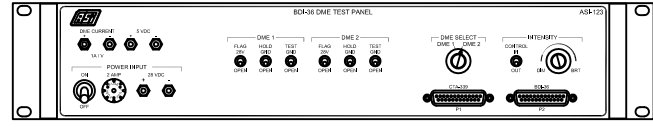

Equipment Supplied:

ASI MN	OEM PN	Description
ASI-12-3A	NPN	Cable, ASI-123 to BDI-36

Optional Equipment:

ASI MN	OEM PN	Description
ASI-12-3B	NPN	Cable, ASI-123 to Colt CTS-703 / CTA-339B1
ASI-12-3C	NPN	Cable, ASI-123 to ASI-176A / ASI-176BR
ASI-12-3C1	NPN	Cable, ASI-123 to ASI-176-1
ASI-165	522-3498-000	Synchro Simulator (CSS-10)
ASI-167	622-5330-001	Synchro Simulator (978F-2S)
ASI-176-1	NPN	Digital DME Indicator Test Set
ASI-187	622-2914-001	RMI Test Panel (970E-1)

CAD-870G Test Panel

ASI-124

OEM Equivalent: Rockwell Collins MN: NMN PN: NPN Manual: 523-0774234 Manual Figure: 5-6	UUT: CAD-870G Size: H: 5.25" W: 19.00" D: 7.00" Pwr: 28 VDC
---	---

Description:
The ASI-124 Test Panel provides interface between the CAD-870G and the data bus simulator required for testing. The ASI-124 duplicates the performance of the CAD-870G Test Fixture shown in the Collins maintenance manual. The test panel includes test points, discrettes, and interconnection required for testing.

The ASI-124 is supplied with two CAD-870G test cables (ASI-12-4A / ASI-12-4B). The ASI-401-1 is required to interface the ASI-124 to the data bus simulator (PC). The test software required for testing must be purchased direct from Collins to ensure the latest revision level.

See the ASI-2000 and ASI-200-14 catalog pages for alternate test equipment available from ASI for testing the CAD-870G.

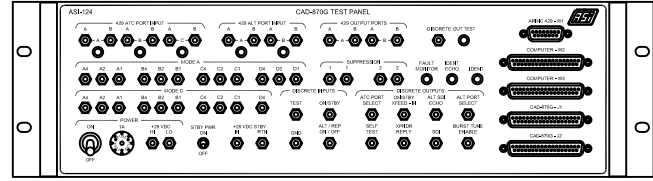

Equipment Supplied:

ASI MN	OEM PN	Description
ASI-12-4A	NPN	Cable, ASI-124 to CAD-870G (P1)
ASI-12-4B	NPN	Cable, ASI-124 to CAD-870G (P2)

Test Software:
523-0777-531 CAD-870G Test Program (PC)

Optional Equipment:

ASI MN	OEM PN	Description
ASI-401-1	NPN	Pro Line PC Interface Panel
CTC-429	822-0854-001	ARINC 429 / CSDB Interface Card (ISA)

VHF-21/22/422 Test Panel

ASI-125

OEM Equivalent: Rockwell Collins MN: NMN PN: NPN Manual: 523-0771854 / 523-0773785 Manual Figure: 5-25 / 5-24	UUT: VHF-21A/B / VHF-22A/B/C/D VHF-422A/B/C/D Size: H: 3.50" W: 19.00" D: 7.00" Pwr: 28 VDC
---	--

Description:
The ASI-125 Test Panel provides interface between the VHF-21/22/422 and the data bus simulator required for testing. The ASI-125 duplicates the performance of the Interface Test Fixture shown in the Collins VHF-21/22 and VHF-422 maintenance manuals. The test panel includes all test points, and discrettes required for testing.

The ASI-125 requires optional test cables for interconnection of the uut. The ASI-12-5B cable allows manual (non-computer) control using a CTL-22. The ASI-401-1 is required to interface the ASI-125 to the data bus simulator (PC). The test software required for testing must be purchased direct from Collins to ensure the latest revision level.

For test equipment required for VHF-21 remote COMM control testing see the ASI-217 catalog page. See the ASI-2000, ASI-200-3, and ASI-200-11 catalog pages for alternate test equipment available from ASI for testing the VHF-21, VHF-22, and VHF-422.

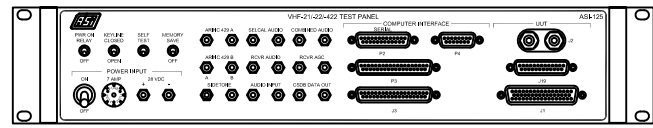

Equipment Supplied:

ASI MN	OEM PN	Description
--------	--------	-------------

Test Software:
523-0777-552 VHF-21/22 Test Program (PC)
523-0777-553 VHF-422 Test Program (PC)

Optional Equipment:

ASI MN	OEM PN	Description
ASI-12-5A	NPN	Cable, ASI-125 to VHF-21A/B
ASI-12-5B	NPN	Cable, ASI-125 to CTL-22 (Manual Control)
ASI-12-5C	NPN	Cable, ASI-125 to VHF-22A/B/C/D
ASI-12-5D	NPN	Cable, ASI-125 to VHF-422A/B/C/D
ASI-217	NPN	VHF-20/21 Test Panel (Manual Control)
ASI-401-1	NPN	Pro Line PC Interface Panel
CTC-429	822-0854-001	ARINC 429 / CSDB Interface Card (ISA)

CTL-X2/-X2A/-X2C/-23 Test Panel

ASI-126

OEM Equivalent: Rockwell Collins
 MN: NMN
 PN: NPN
 Manual: 523-0772495 / 523-0776775
 Manual Figure: 5-1 / 902

UUT: CTL-22/-22A/-22C/-23/-32/-32A
 CTL-62/-62A/-92/-92A
 Size: H: 3.50" W: 19.00" D: 7.00"
 Pwr: 28 VDC

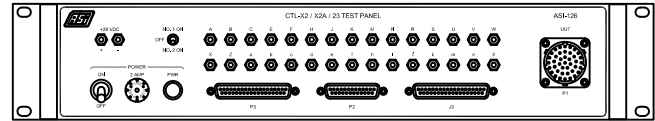

Description:
 The ASI-126 Test Panel provides interface between the Collins CTL-X2/A/C/23 Controls and the data bus simulator required for testing. The ASI-126 duplicates the performance of the Test Set shown in the Collins VHF-X2/X2A and CTL-23 maintenance manuals. The test panel includes all test points, and discretes.

The ASI-126 requires optional test cables for interconnection of the uut. The ASI-401-1 is required to interface the ASI-126 to the data bus simulator (PC with CTC-429). The test software required for testing must be purchased direct from Collins to ensure the latest revision level.

See the ASI-2000 and ASI-200-1 catalog pages for alternate test equipment available from ASI for testing the CTL-X2/X2A/22C/23 Controls.

Test Software:
 523-0777-532 CTL-23 Test Program (PC)
 523-0777-533 CTL-22/-22A/22C Test Program (PC)
 523-0777-534 CTL-32/-32A Test Program (PC)
 523-0777-535 CTL-62/62A Test Program (PC)
 523-0777-536 CTL-92/92A Test Program (PC)

Optional Equipment:

ASI MN	OEM PN	Description
ASI-12-6A	NPN	Cable, ASI-126 to CTL-22/-22A/-22C
ASI-12-6B	NPN	Cable, ASI-126 to CTL-32/-32A
ASI-12-6C	NPN	Cable, ASI-126 to CTL-62/-62A
ASI-12-6D	NPN	Cable, ASI-126 to CTL-92/-92A
ASI-12-6E	NPN	Cable, ASI-126 to CTL-23
ASI-10-1D1	NPN	Extender Cable, CTL-X2/X2A-A6
ASI-10-1E	NPN	Extender Cable, CTL-X2/X2A-A2
ASI-10-1F	NPN	Extender Cable, CTL-X2/X2A-A3
ASI-10-1G	NPN	Extender Cable, CTL-X2/X2A-A1/A2
ASI-401-1	NPN	Pro Line PC Interface Panel
ASI-2001	NPN	Pro Line Computer System
ASI-CTC-429	822-0854-001	ARINC 429 / CSDB Interface Card (ISA)

VIR-30/-31/-32/-33 Manual Test Panel

ASI-127-1

OEM Equivalent: Rockwell Collins
 MN: NMN
 PN: NPN
 Manual: 523-0772819
 Manual Figure: 5-14

UUT: VIR-30A/-30M / VIR-31A/-31H
 VIR-32 / VIR-33
 Size: H: 7.00" W: 19.00" D: 7.00"
 Pwr: 28 VDC / 26 VAC 400 Hz

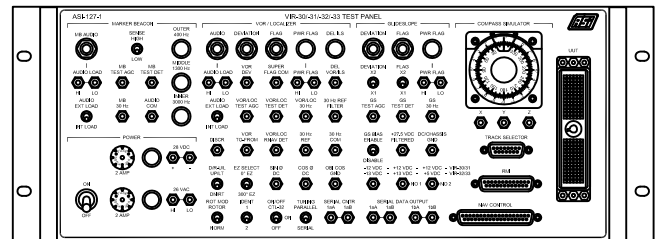

Description:
 The ASI-127-1 Test Panel provides interface between the VIR-30/-31/-32/-33 and standard avionics test equipment required for manual (non-computer) testing. The ASI-127-1 duplicates the performance of the Manual (Method 2) Test Fixture shown in the Collins VIR-32/33 maintenance manual. The test panel includes test points, discretes, and interconnection.

The ASI-127-1 requires optional cables for interconnection of the uut and associated test equipment. These cables are listed in the Optional Equipment section.

See the ASI-128, ASI-2000, and ASI-200-2() catalog pages for alternate test equipment available from ASI for computer testing of the VIR-32/-33.

Equipment Supplied:
 ASI MN OEM PN Description

Optional Equipment:

ASI MN	OEM PN	Description
ASI-12-71A	NPN	Cable, ASI-127-1 to VIR-30/-31/-32/-33
ASI-12-71B	NPN	Cable, ASI-127-1 to CTL-32
ASI-12-71C	NPN	Cable, ASI-12-71A to 699Z-1
ASI-12-7B	NPN	Cable, ASI-127-1 to RMI-30
ASI-12-7C	NPN	Cable, ASI-127-1 to RMI-36
ASI-12-7D	NPN	Cable, ASI-127-1 to ASI-161 / 479V-3
ASI-12-7E	NPN	Cable, ASI-127-1 to 313N()
ASI-12-7F	NPN	Cable, ASI-127-1 to CTL-30
ASI-12-7G	NPN	Cable, ASI-127-1 to ASI-190B
ASI-161	522-1339-000	Precision Track Selector (479V-3)
ASI-190B	NPN	Precision Track Selector with Meters

VIR-32/-33/-432/-433 Test Panel

ASI-128

OEM Equivalent: Rockwell Collins
 MN: NMN
 PN: NPN
 Manual: 523-0772819 / 523-0773863
 Manual Figure: 5-10 - 5-11 / 5-9

UUT: VIR-32 / VIR-33
 VIR-432 / VIR-433
 Size: H: 7.00" W: 19.00" D: 7.00"
 Pwr: 28 VDC / 26 VAC 400 Hz

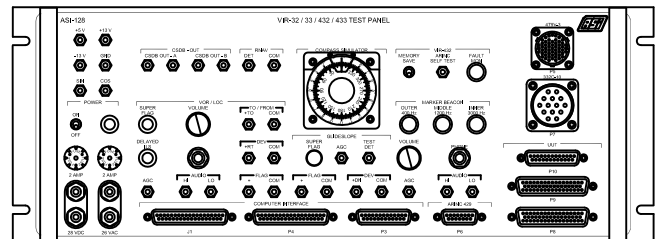

Description:
 The ASI-128 Test Panel provides interface between the VIR-32/-33 / VIR-432/-433 and the data bus simulator required for testing. The ASI-128 duplicates the performance of the Interface Test Fixture shown in the Collins VHF-32/-33 and VHF-422/-433 maintenance manuals. The test panel includes all test points, and discretes required for testing.

The ASI-128 requires optional test cables for interconnection of the uut. The ASI-12-8A cable allows manual (non-computer) control using a CTL-32. The ASI-401-1 is required to interface the ASI-128 to the data bus simulator (PC with CTC-429). The test software required for testing must be purchased direct from Collins to ensure the latest revision level.

See the ASI-2000 and ASI-200-2() catalog pages for alternate test equipment available from ASI for testing the VIR-32/-33/-432/-433.

Test Software:
 523-0777-554 VIR-32/-33 Test Program (PC)
 523-0777-555 VIR-432/-433 Test Program (PC)

Optional Equipment:

ASI MN	OEM PN	Description
ASI-12-8A	NPN	Cable, ASI-128 to CTL-32
ASI-12-8B	NPN	Cable, ASI-128 to VIR-32/-33
ASI-12-8C	NPN	Cable, ASI-128 to VIR-432/-433
ASI-12-8D	NPN	Cable, ASI-128 to 332C-10
ASI-12-8E	NPN	Cable, ASI-128 to ASI-161 / 479V-3
ASI-12-8F	NPN	Cable, ASI-128 to ASI-190() / -160() OBS
ASI-12-8G	NPN	Cable, ASI-128 to ASI-160() OBI
ASI-12-8H	NPN	Cable, ASI-128 to RMI-36
ASI-10-2K	NPN	Extender Cable, VIR-32/-33 A5P1
ASI-10-2L	NPN	Extender cable, VIR-32/-33 A5P2
ASI-161	522-1339-000	Precision Track Selector (479V-3)
ASI-401-1	NPN	Pro Line PC Interface Panel
ASI-2001	NPN	Pro Line Computer System
ASI-CTC-429	822-0854-001	ARINC 429 / CSDB Interface Card (ISA)

CAD-31/-62 Test Panel

ASI-129

OEM Equivalent: Rockwell Collins
 MN: NMN
 PN: NPN
 Manual: 523-0773216
 Manual Figure: 5-8

UUT: CAD-31
 CAD-62
 Size: H: 3.50" W: 19.00" D: 7.00"
 Pwr: 28 VDC

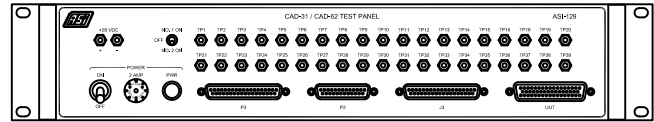

Description:
 The ASI-129 Test Panel provides interface between the CAD-31/-62 and the data bus simulator required for testing. The ASI-129 duplicates the performance of the CAD-31/-62 Test Panel shown in the Collins maintenance manual. The test panel includes interconnections, test points, and discretes required for testing.

Test Software:
 523-0777-529 CAD-31 Test Program (PC)
 523-0777-528 CAD-62 Test Program (PC)

The ASI-129 includes the interconnect cable required to interface the CAD-31/-62 to the test panel. The ASI-401-1 is required to interface the ASI-129 to the data bus simulator (PC). The test software required for testing must be purchased direct from Collins to insure the latest revision level.

Equipment Supplied:

ASI MN	OEM PN	Description
ASI-12-9A	NPN	Cable, ASI-120 to CAD-31/-62

See the ASI-2000 and ASI-200-4 catalog pages for alternate test equipment available from ASI for testing the CAD-31/-62.

Optional Equipment:

ASI MN	OEM PN	Description
ASI-401-1	NPN	Pro Line PC Interface Panel
CTC-429	822-0854-001	ARINC 429 / CSDB Interface Card (ISA)

TDR-90 Test Panel

ASI-130

OEM Equivalent: Rockwell Collins
 MN: NMN
 PN: NPN
 Manual: 523-0765128
 Manual Figure: 5-8

UUT: TDR-90
 Size: H: 3.50" W: 19.00" D: 7.00"
 Pwr: 28 VDC

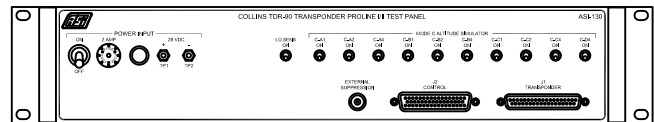

Description:
 The ASI-130 Test Panel provides interface between the TDR-90 and associated test equipment required for testing. The ASI-130 duplicates the performance of the TDR-90 Test Fixture shown in the Collins maintenance manual. The test panel includes a Mode C altitude simulator, test points, and discretes required for testing.

Equipment Supplied:

ASI MN	OEM PN	Description
--------	--------	-------------

The ASI-130 can test the TDR-90 in either Pro Line I or II configuration as shown in the TDR-90 manual. The ASI-13-0C cable is required to interface the uut to the test panel in either configuration. Pro Line I testing requires the optional ASI-13-0A or ASI-13-0D and a user supplied 613L-3 or CTL-90 control. Pro Line II testing requires the optional ASI-13-0B cable, user supplied CAD-62, and CTL-92.

Optional Equipment:

ASI MN	OEM PN	Description
ASI-13-0A	NPN	Cable, ASI-130 to 613L-3
ASI-13-0B	NPN	Cable, ASI-130 to CAD-62 / CTL-92
ASI-13-0C	NPN	Cable, ASI-130 to TDR-90
ASI-13-0D	NPN	Cable, ASI-130 to CTL-90

See the ASI-2000 and ASI-200-14 catalog pages for alternate test equipment available from ASI for testing the TDR-90.

CTL-230 Test Panel

ASI-131

OEM Equivalent: Rockwell Collins
 MN: NMN
 PN: NPN
 Manual: 523-0772869
 Manual Figure: 5-3

UUT: CTL-230
 Size: H: 3.50" W: 19.00" D: 7.00"
 Pwr: 28 VDC

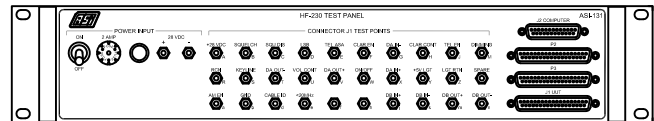

Description:
 The ASI-131 Test Panel provides interface between the CTL-230 and the data bus simulator required for testing. The ASI-131 duplicates the performance of the CTL-230 Test Fixture shown in the Collins maintenance manual. The test panel includes all test points and discretes required for testing.

Test Software:
 523-0777-538 CTL-230 Test Program (PC)

The ASI-130 is supplied with the CTL-230 test cable (ASI-13-1A). The ASI-401-1 is required to interface the ASI-131 to the data bus simulator (PC). The test software required for testing must be purchased direct from Collins to insure the latest revision level.

Equipment Supplied:

ASI MN	OEM PN	Description
ASI-13-1A	NPN	Cable, ASI-131 to CTL-230

See the ASI-2000 and ASI-200-6 catalog pages for alternate test equipment available from ASI for testing the CTL-230.

Optional Equipment:

ASI MN	OEM PN	Description
ASI-401-1	NPN	Pro Line PC Interface Panel
CTC-429	822-0854-001	ARINC 429 / CSDB Interface Card (ISA)

CAD-870 / RAC-870 Test Panel

ASI-132

OEM Equivalent: Rockwell Collins
 MN: NMN
 PN: NPN
 Manual: 523-0774242 / 523-0774271
 Manual Figure: 5-5 / 5-4

UUT: CAD-870
 RAC-870
 Size: H: 5.25" W: 19.00" D: 7.00"
 Pwr: 28 VDC / -15 VDC

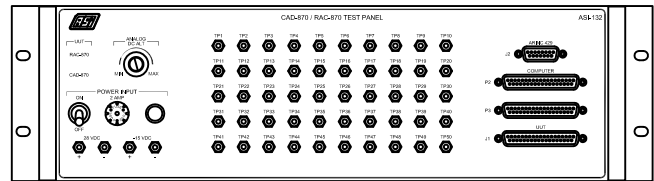

Description:
 The ASI-132 Test Panel provides interface between the CAD-870/RAC-870 and the data bus simulator required for testing. The ASI-132 duplicates the performance of the CAD-870/RAC-870 Test Panel shown in the Collins maintenance manual. The test panel includes interconnections, test points, and discretes required for testing.

Test Software:
 523-0777-530 CAD-870 Test Program (PC)
 523-0777-549 RAC-870 Test Program (PC)

The ASI-132 requires the optional ASI-13-2A test cable for proper operation. The ASI-401-1 is required to interface the ASI-132 to the data bus simulator (PC). The test software required for testing must be purchased direct from Collins to insure the latest revision level.

Optional Equipment:

ASI MN	OEM PN	Description
ASI-13-2A	NPN	Cable, ASI-132 to CAD-870 / RAC-870
ASI-401-1	NPN	Pro Line PC Interface Panel
CTC-429	822-0854-001	ARINC 429 / CSDB Interface Card (ISA)

See the ASI-2000 and ASI-200-18 catalog pages for alternate test equipment available from ASI for testing the CAD-870 / RAC-870.

RTU-870 Test Panel

ASI-133

OEM Equivalent: Rockwell Collins MN: NMN PN: NPN Manual: 523-0774068 Manual Figure: 901	UUT: RTU-870A/-870B/-870C RTU-870F/-870T
	Size: H: 5.25" W: 19.00" D: 7.00" Pwr: 28 VDC

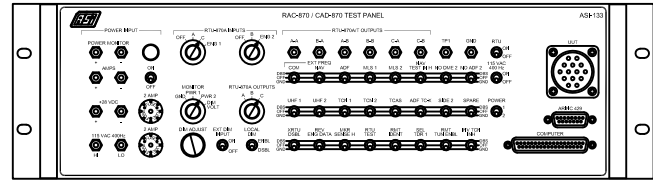

Description:
The ASI-133 Test Panel provides interface between the RTU-870() and the data bus simulator required for testing. The ASI-133 duplicates the performance of the RTU-870() Interface Fixture shown in the Collins maintenance manual. The test panel includes interconnection, test points, and discrettes.

The ASI-133 is supplied with the RTU-870() test cable (ASI-13-3A). Optional RTU-870() circuit card extenders are also available. The ASI-401-1 is required to interface the ASI-133 to the data bus simulator (PC). The test software required for testing must be purchased direct from Collins to insure the latest revision level.

See the ASI-2000 and ASI-200-17A catalog pages for alternate test equipment available from ASI for testing the RTU-870().

Test Software:
523-0777-550 RTU-870() Test Program (PC)

Optional Equipment:

ASI MN	OEM PN	Description
ASI-10-17A-A2	NPN	Extender Card, RTU-870() A2
ASI-10-17A-A3	NPN	Extender Card, RTU-870() A3
ASI-401-1	NPN	Pro Line PC Interface Panel
ASI-CTC-429	822-0854-001	ARINC 429 / CSDB Interface Card (CTC-429)

Equipment Supplied:

ASI MN	OEM PN	Description
ASI-13-3A	NPN	Cable, ASI-133 to RTU-870()

DME-42 / DME-442 Test Panel

ASI-134

OEM Equivalent: Rockwell Collins MN: NMN PN: NPN Manual: 523-0772458 / 523-0774368 Manual Figure: 1 - 2 (Appendix D)	UUT: DME-42 / DME-442 IND-42A / IND-42C / IND-42M
	Size: H: 7.00" W: 19.00" D: 7.00" Pwr: 28 VDC

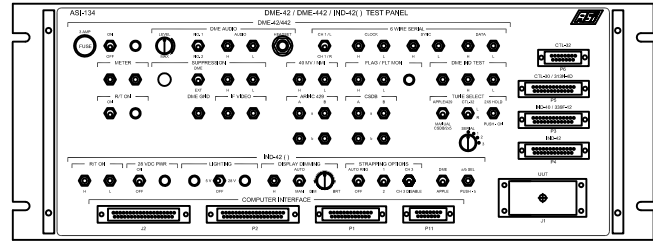

Description:
The ASI-134 Test Panel provides interface between the DME-42/-442, IND-42() and the data bus simulator required for testing. The ASI-125 duplicates the performance of the DME-42/-442 Test Panel shown in the Collins maintenance manuals. The test panel includes interconnection, test points, and discrettes required for testing.

The ASI-134 requires an optional uut test cable for proper operation. Optional Indicator and control cables are also available. The ASI-401-1 is required to interface the ASI-134 to the data bus simulator (PC). The test software required for testing must be purchased direct from Collins to insure the latest revision level.

The functions of the Digital Simulator Board (ASI-200-5A1) and the Power Supply Load Test Fixture are both incorporated into the design of the ASI-134.

See the ASI-2000, ASI-200-5, ASI-200-5A1, and ASI-200-13 catalog pages for alternate test equipment available from ASI for testing the DME-42/-442.

Test Software:
523-0777-540 DME-42 Test Program (PC)
523-0777-541 DME-442 Test Program (PC)
523-0777-547 IND-42() Test Program (PC)

Optional Equipment:

ASI MN	OEM PN	Description
ASI-13-4A	NPN	Cable, ASI-134 to DME-42
ASI-13-4B	NPN	Cable, ASI-134 to IND-42
ASI-13-4C	NPN	Cable, ASI-134 to IND-40 / IND-41 / 339F-12
ASI-13-4D	NPN	Cable, ASI-134 to CTL-30
ASI-13-4E	NPN	Cable, ASI-134 to 313N-4D
ASI-13-4F	NPN	Cable, ASI-134 to CTL-32
ASI-13-4G	NPN	Cable, ASI-134 to Squawk-Naut
ASI-13-4H	NPN	Cable, ASI-134 to DME-442
ASI-13-4I	NPN	Cable, ASI-134 to IFR-1400A
ASI-401-1	NPN	Pro Line PC Interface Panel
ASI-CTC-429	822-0854-001	ARINC 429 / CSDB Interface Card (CTC-429)

Equipment Supplied:

ASI MN	OEM PN	Description
ASI-200-5A1	647-6787-001	DME Simulator Card (Internally Mounted)

ADF-462 Test Panel

ASI-135

OEM Equivalent: Rockwell Collins MN: NMN PN: NPN Manual: 523-0773906 Manual Figure: 5-6	UUT: ADF-462 ANT-462A/-462B
	Size: H: 3.50" W: 19.00" D: 7.00" Pwr: 28 VDC

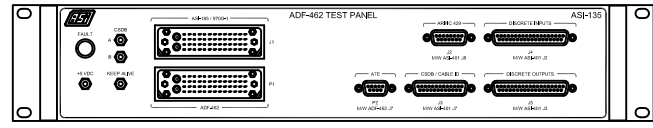

Description:
The ASI-135 Test Panel expands the capability of the 970G-1 (ASI-185) to test the ADF-462 and ANT-462A/-462B.

The ASI-135 provides interface between the ADF-462, 970G-1 (ASI-185), and the data bus simulator required for testing. The ASI-135 duplicates the performance of the ADF-462 Test Fixture shown in the Collins maintenance manual. The test panel includes all test points, and discrettes required for testing.

The ASI-135 requires optional test cables for interconnection of the uut. The ASI-401-1 is required to interface the ASI-135 to the data bus simulator (PC). The test software required for testing must be purchased direct from Collins to insure the latest revision level.

See the ASI-2000 and ASI-200-10 catalog pages for alternate test equipment available from ASI for testing the ADF-462.

Test Software:
523-0777-526 ADF-462 Test Program (PC)

Optional Equipment:

ASI MN	OEM PN	Description
ASI-13-5A	NPN	Cable, ASI-135 to ADF-462-P1
ASI-13-5B	NPN	Cable, ASI-135 to ADF-462-J7 (Auto Test)
ASI-18-5C	NPN	Cable, ASI-185 to ANT-60B/-462B
ASI-61	622-3099-001	ADF Antenna Sim / 19" Panel
ASI-61W	622-3099-001	ADF Antenna Sim / Control Head (970W-1)
ASI-83C	NPN	Audio Watt Meter
ASI-185	622-2854-001	ADF Test Panel (970G-1)
ASI-278	622-3874-001	ADF Antenna Tester (969W-1)
ASI-401-1	NPN	Pro Line PC Interface Panel
ASI-CTC-429	822-0854-001	ARINC 429 / CSDB Interface Card (CTC-429)

Equipment Supplied:

ASI MN	OEM PN	Description
--------	--------	-------------

Heading Synchro Kit
 Heading Control Transformer Kit
 To-From Meter Kit
 Flag Meter Kit
 Deviation Meter Kit
 Track Selector Kit

ASI-140
 ASI-141
 ASI-145
 ASI-146
 ASI-147
 ASI-150

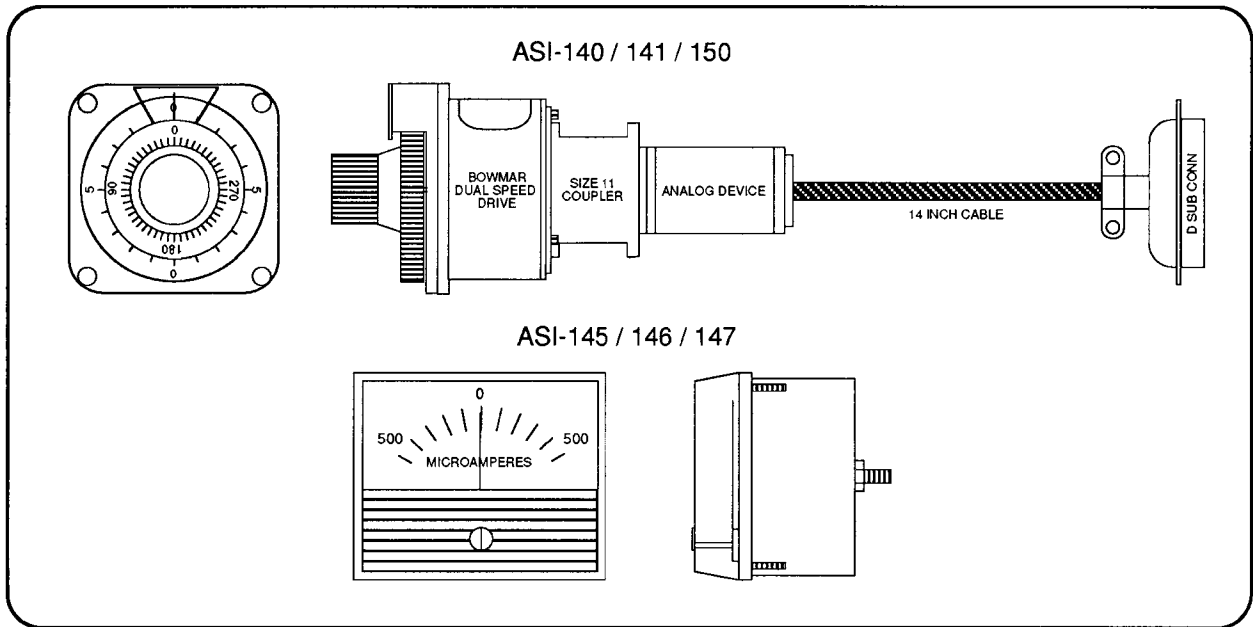

This unit is manufactured to replace the OEM model and/or part number listed below in form, fit, and function.

Equivalent OEM:
 Equivalent MN:
 Equivalent PN:
 Manual Figure:

Units Tested: Various

Description of Operation:

- ASI-140 Heading Synchro Kit (Bowmar dual speed drive coupled to a synchro)
- ASI-141 Heading Control Transformer Kit (Bowmar dual speed drive coupled to a control transformer)
- ASI-145 To-From Meter (500-0-500 μ A meter wired for single meter loading)
- ASI-146 Flag Meter (0-500 μ A meter wired for single meter loading)
- ASI-147 Deviation Meter (100-0-100 μ A meter wired for single meter loading)
- ASI-150 Track Selector Kit (Bowmar dual speed drive coupled to a resolver)

These kits provide a quick and efficient means of upgrading existing test panels for greater service capability. All of the above listed kits come prewired and calibrated for easy installation.

Specifications:

Height: 2.250 " Width: 2.250" Depth: 5.500" (ASI-140 / 141 / 150)
 Height: 2.375 " Width: 2.750" Depth: 2.250" (ASI-145 / 146 / 147)

Equipment Supplied:

ASI MN	Equivalent PN	Description
--------	---------------	-------------

Optional Equipment:

ASI MN	Equivalent PN	Description
ASI-166	522-0167-001	Resolver Zeroing Panel (479X-2)
ASI-215		Synchro/Resolver/Control Transformer Test Panel

REV 2
 11-1-94

Compass Simulator

ASI-142-1

OEM Equivalent: Rockwell Collins MN: 477L-1 PN: 522-1147-004 Manual: Manual Figure:	UUT: Various Avionics Size: H: 4.50" W: 8.37" D: 5.00" Pwr: From UUT
---	--

Description:
The ASI-142-1 Compass Simulator provides the simulated gyrocompass output that is required for testing various avionics units. The front panel switch can be wired through the rear connector to control an external piece of equipment.

The ASI-142-1 is synchro mounted in a compact package that can be installed into a top level test panel. Snap slide latches are included to hold the compass simulator securely in place.

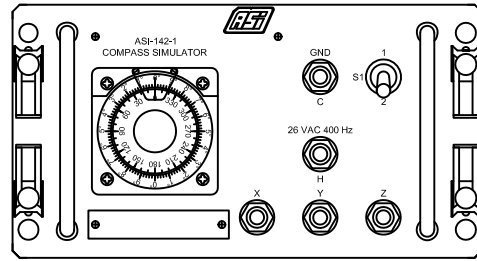

Equipment Supplied:		Optional Equipment:
<u>ASI MN</u>	<u>OEM PN</u> MS3106F20-27S	<u>Description</u> Mating Connector

<u>ASI MN</u>	<u>OEM PN</u>	<u>Description</u>
---------------	---------------	--------------------

Compass Simulator

ASI-142-2

OEM Equivalent: Rockwell Collins MN: 477L-1 PN: 522-1147-004 Manual: Manual Figure:	UUT: Various Avionics Size: H: 3.50" W: 19.00" D: 5.00" Pwr: From UUT
---	---

Description:
The ASI-142-2 Compass Simulator provides the simulated gyrocompass output that is required for testing various avionics units. The front panel switch can be wired through the rear connector to control an external piece of equipment.

The ASI-142-2 is a synchro mounted in a standard 19 inch rack mount chassis. Because of the difference in size the ASI-142-2 is only functionally equivalent to the 477L-1. See the ASI-142-1 for a Form, Fit, and Function equivalent to the 477L-1.

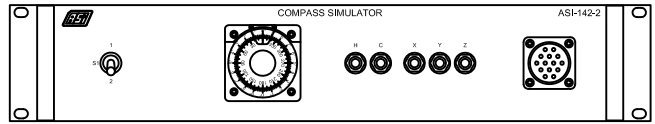

Equipment Supplied:		Optional Equipment:
<u>ASI MN</u>	<u>OEM PN</u> MS3106F20-27S	<u>Description</u> Mating Connector

<u>ASI MN</u>	<u>OEM PN</u>	<u>Description</u>
---------------	---------------	--------------------

Gyro Simulator

ASI-143-1

OEM Equivalent: Rockwell Collins MN: 477K-1 PN: 522-1146-004 Manual: 520-5826000 Manual Figure: 1	UUT: Various Avionics Size: H: 4.50" W: 8.37" D: 5.00" Pwr: From UUT
---	--

Description:
The ASI-143-1 Gyro Simulator provides the simulated gyrocompass output that is required for testing various avionics units. The front panel switches can be wired through the rear connector to control an external piece of equipment.

The ASI-143-1 is a synchro mounted in a compact package that can be installed into a top level test panel. Snap slide latches are included to hold the compass simulator securely in place.

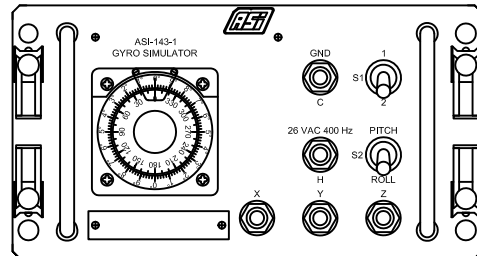

Equipment Supplied:		Optional Equipment:
<u>ASI MN</u>	<u>OEM PN</u> 165-26	<u>Description</u> Mating Connector

<u>ASI MN</u>	<u>OEM PN</u>	<u>Description</u>
---------------	---------------	--------------------

Gyro Simulator

ASI-143-2

OEM Equivalent: Rockwell Collins MN: 477K-1 PN: 522-1146-004 Manual: 520-5826000 Manual Figure: 1	UUT: Various Avionics Size: H: 3.50" W: 19.00" D: 5.00" Pwr: From UUT
---	---

Description:
The ASI-143-2 Gyro Simulator provides the simulated gyrocompass output that is required for testing various avionics units. The front panel switches can be wired through the rear connector to control an external piece of equipment.

The ASI-143-2 is a synchro mounted in a standard 19 inch rack mount chassis. Because of the difference in size the ASI-143-2 is only functionally equivalent to the 477K-1. See the ASI-143-1 for a Form, Fit, and Function equivalent to the 477K-1.

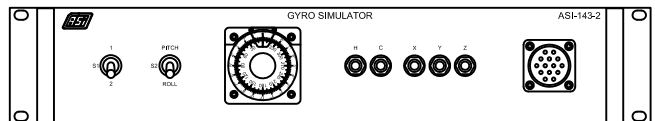

Equipment Supplied:		Optional Equipment:
<u>ASI MN</u>	<u>OEM PN</u> 165-26	<u>Description</u> Mating Connector

<u>ASI MN</u>	<u>OEM PN</u>	<u>Description</u>
---------------	---------------	--------------------

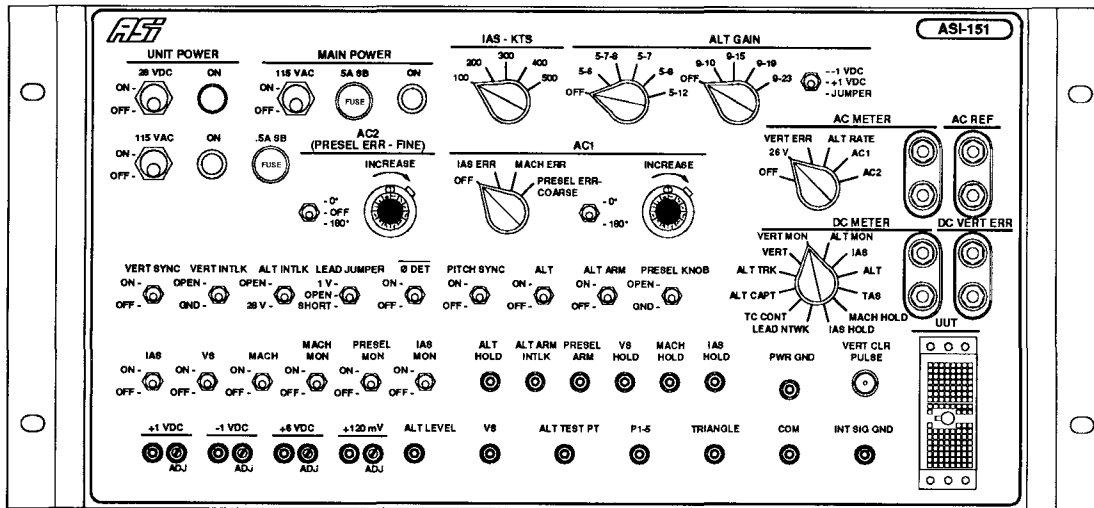

This unit is manufactured to replace the OEM model and/or part number listed below in form, fit, and function.

Equivalent OEM: Collins

Equivalent MN:

Equivalent PN:

Manual Figure: 590A-3H/3J/3K, Fig. 1002-1004

590A-3J1/3K1, Fig. 2-4 - 2-5

Units Tested:

590A-3H Air Data Control

590A-3J Air Data Control

590A-3J1 Air Data Control

590A-3K Air Data Control

590A-3K1 Air Data Control

Description of Operation:

The ASI-151 Air Data Control Test Panel provides the means to align, test, and troubleshoot the Collins 590A-3 () Air Data Controls listed above. The Test Panel provides power (+28VDC, ±12VDC, ±1 VDC and +120 mVDC) to the unit under test, simulates all necessary inputs to the Air Data Control, and allows the monitoring of test parameters by means of test points and meter jacks.

Specifications:

Height: 7.00" Width: 19.00" Depth: 6.00" Power: 115 VAC 400 Hz

Equipment Supplied:

ASI MN	Equivalent PN	Description
ASI-15-1A		Cable: ASI-151 to 590A-3()

Optional Equipment:

ASI MN	Equivalent PN	Description
--------	---------------	-------------

RDR-1F Radar Test Panel

ASI-152-1

OEM Equivalent:

OEM: Bendix
 Model Number: RDT-1F
 Part Number: 2038139-0501
 Manual: I.B. 1102ET / 34-42-55
 Manual Figure: 1

This unit is manufactured to replace the OEM MN, PN, and/or manual figure listed in Form, Fit, and Function.

Description:

The ASI-152-1 Radar Test Panel facilitates testing, alignment, and troubleshooting of the Bendix RDR-1F Weather Radar Receiver-Transmitter.

The Test Panel contains circuitry for simulating loads on the R/T unit servo and resolver amplifiers. The ASI-152-1 also has the ability to simulate the CON-1() Control Panel which eliminates the need for additional system components during bench testing.

The ASI-152-1 includes all test cables required to interconnect the R/T to the Test Panel.

Test panels designed to test other units of the RDR-1F Weather Radar System are also available from Avionics Specialist, Inc. These test panels are listed in the optional equipment section below.

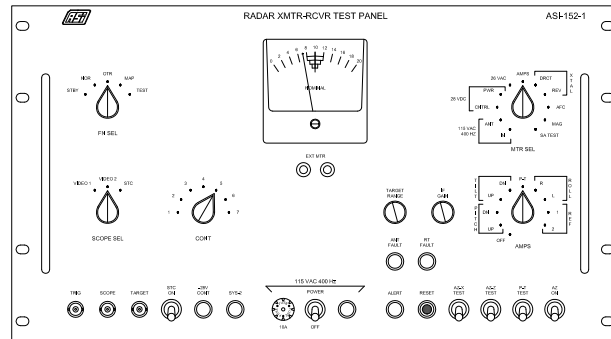

Units Tested:

RDR-1F

Specifications:

Height: 10.50" Width: 19.00" Depth: 17.00"
 Power Requirements: 115 VAC 400 Hz

Equipment Supplied:

ASI MN	OEM PN	Description
ASI-15-2A	2038272-0501	Cable, ASI-152-1 to RDR-1F (W101)
ASI-15-2B	2038273-0501	Cable, ASI-152-1 to RDR-1F (W102)
ASI-15-2C	2038274-0501	Cable, ASI-152-1 to RDR-1F (W103)
ASI-15-2D	2038275-0501	Cable, ASI-152-1 PWR Connector (W104)

Optional Equipment:

ASI MN	OEM PN	Description
ASI-153-1	2038070-0501	ANT-1T Radar Ant Test Panel (ATT-1F)
ASI-154-1	2038326-0501	RDR-1F Radar System Test Panel (RCT-1F)
ASI-174	2038141-0501	PPI-1 Radar Indicator Test Panel (PPT-1B)

RDR-1FB Radar Test Panel

ASI-152-2

OEM Equivalent:

OEM: Bendix
 Model Number: RDT-1FB
 Part Number: 2041351-0102
 Manual: I.B. 1103AT-1 / 34-43-08
 Manual Figure: 1

This unit is manufactured to replace the OEM MN, PN, and/or manual figure listed in Form, Fit, and Function.

Description:

The ASI-152-2 Radar Test Panel facilitates testing, alignment, and troubleshooting of the Bendix RDR-1FB System Weather Radar Receiver-Transmitters (RTA-1FB), including the RTA-1FB(M) which have sector scan and variable STC capability.

The Test Panel contains circuitry for simulating loads on the R/T unit servo and resolver amplifiers. The ASI-152-2 also has the ability to simulate the CON-1SB Control Panel which eliminates the need for additional system components during bench testing.

The ASI-152-2 includes all test cables required to interconnect the R/T to the Test Panel.

Test panels designed to test other units of the RDR-1FB Weather Radar System are also available from Avionics Specialist, Inc. These test panels are listed in the optional equipment section below.

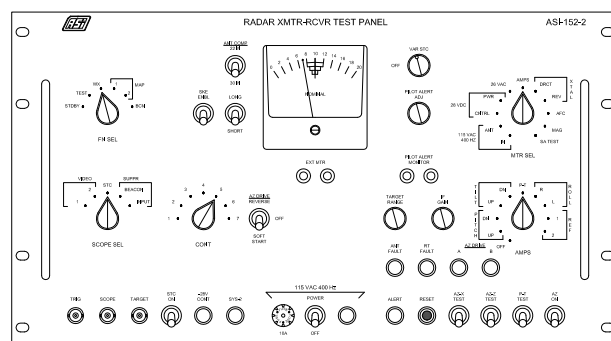

Units Tested:

RTA-1FB
 RTA-1FB(M)

Specifications:

Height: 10.50" Width: 19.00" Depth: 17.00"
 Power Requirements: 115 VAC 400 Hz

Equipment Supplied:

ASI MN	OEM PN	Description
ASI-15-22A	8056334-0501	Cable, ASI-152-2 to RTA-1FB/FB(M) (W101)
ASI-15-22B	2041576-0502	Cable, ASI-152-2 to RTA-1FB/FB(M) (W102)
ASI-15-22C	2038274-0501	Cable, ASI-152-2 to RTA-1FB/FB(M) (W103)
ASI-15-22D	2038275-0502	Cable, ASI-152-2 PWR Connector (W104)

Optional Equipment:

ASI MN	OEM PN	Description
ASI-153-2	2038070-0502	ANT-1TB Radar Ant Test Panel (ATT-1FB)
ASI-154-2	2038326-0501	RDR-1FB Radar System Test Panel (RCT-1FB)
ASI-244-1	2041349-0102	PPI-1FB Radar Indicator Test Panel (PPT-1FB)
ASI-252-1	2041348-0102	CON-1RB/SB Control Test Panel (COT-1FB)

ANT-1T Radar Antenna Test Panel

ASI-153-1

OEM Equivalent:

OEM: Bendix
 Model Number: ATT-1F
 Part Number: 2038270-0501
 Manual: I.B. 1102CT / 34-42-53
 Manual Figure: 1

This unit is manufactured to replace the OEM MN, PN, and/or manual figure listed in Form, Fit, and Function.

Description:

The ASI-153-1 Radar Antenna Test Panel facilitates testing, alignment, and troubleshooting of the Bendix ANT-1T Weather Radar Antenna.

The ASI-153-1 circuitry provides input power, simulated data, switching, and monitoring required for proper testing and calibration of the antenna with a minimum of external test equipment. The test panel contains three variable synchros that simulate Gyro Roll, Gyro Pitch, and CON-1() Tilt Control.

The ASI-153-1 includes a test interconnect cable for the ANT-1T.

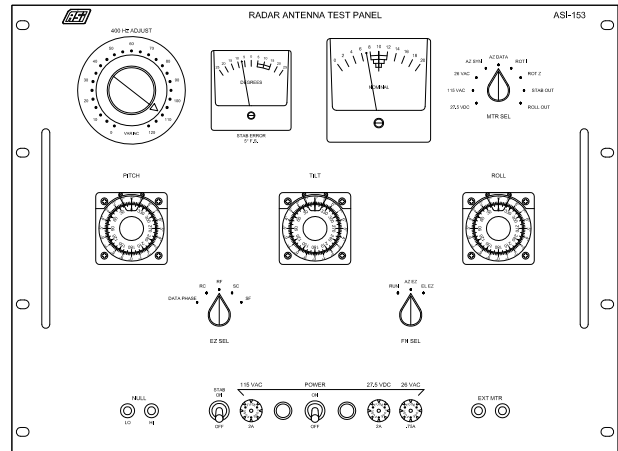

Units Tested:

ANT-1T

Specifications:

Height: 14.00" Width: 19.00" Depth: 17.00"
 Power Requirements: 115 VAC 400 Hz / 28 VDC

Equipment Supplied:

ASI MN	OEM PN	Description
ASI-15-3A	2038308-0501	Cable, ASI-153-1 PWR Connector (W101)
ASI-15-3B	2038309-0501	Cable, ASI-153-1 to ANT-1T (W102)

Optional Equipment:

ASI MN	OEM PN	Description
ASI-154-1	2038326-0501	RDR-1F Radar System Test Panel (RCT-1F)

ANT-1TB Radar Antenna Test Panel

ASI-153-2

OEM Equivalent:

OEM: Bendix
 Model Number: ATT-1FB
 Part Number: 2038270-0502
 Manual: I.B. 1103ET / 34-43-07
 Manual Figure: 1

This unit is manufactured to replace the OEM MN, PN, and/or manual figure listed in Form, Fit, and Function.

Description:

The ASI-153-2 Radar Antenna Test Panel facilitates testing, alignment, and troubleshooting of the Bendix ANT-1T/1TB Weather Radar Antenna.

The ASI-153-2 circuitry provides input power, simulated data, switching, and monitoring required for proper testing and calibration of the antenna with a minimum of external test equipment. The test panel contains three variable synchros that simulate Gyro Roll, Gyro Pitch, and CON-1()B Tilt Control.

The ASI-153-2 includes a test interconnect cable for the ANT-1TB.

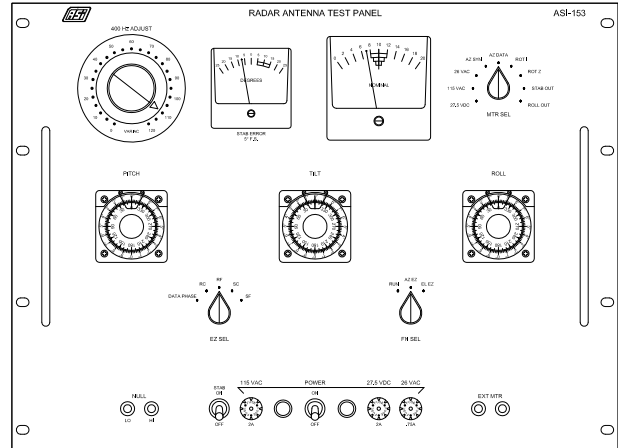

Units Tested:

ANT-1T ANT-1TB

Specifications:

Height: 14.00" Width: 19.00" Depth: 17.00"
 Power Requirements: 115 VAC 400 Hz / 28 VDC

Equipment Supplied:

ASI MN	OEM PN	Description
ASI-15-3A	2038308-0501	Cable, ASI-153-2 PWR Connector (W101)
ASI-15-3B	2038309-0501	Cable, ASI-153-2 to ANT-1TB (W102)

Optional Equipment:

ASI MN	OEM PN	Description
ASI-154-2	2041349-0102	RDR-1FB Radar System Test Panel (RCT-1FB)

ANT-1TB(M) Radar Antenna Test Panel

ASI-153-3

OEM Equivalent:

OEM: Bendix
 Model Number: ATT-1FB
 Part Number: 2038270-0503
 Manual: I.B. 1102CT / 34-42-53
 Manual Figure: 1

This unit is manufactured to replace the OEM MN, PN, and/or manual figure listed in Form, Fit, and Function.

Description:

The ASI-153-3 is similar to the ASI-153-2 with the addition of the ASI-153-4 Sector Scan Test Adapter and the ASI-15-3C Test Cable. The ASI-153-4 requires a user supplied CON-1TB(M) for operation.

Units Tested:

ANT-1TB(M)

Equipment Supplied:

ASI MN	OEM PN	Description
ASI-15-3A	2038308-0501	Cable, ASI-153-3 PWR Connector (W101)
ASI-15-3C	8056302-0501	Cable, ASI-153-3 to ANT-1TB(M) (W103)
ASI-153-4	8056275-0501	Sector Scan Test Adapter (ANT-1FBM)

Optional Equipment:

ASI MN	OEM PN	Description
ASI-154-2	2041349-0102	RDR-1FB Radar System Test Panel (RCT-1FB)

RS

RDR-1F Radar System Test Panel

ASI-154-1

OEM Equivalent:

OEM: Bendix
 Model Number: RCT-1F
 Part Number: 2038326-0501
 Manual: I.B. 1102BT / 34-42-52
 Manual Figure: 1

This unit is manufactured to replace the OEM MN, PN, and/or manual figure listed in Form, Fit, and Function.

Description:

The ASI-154-1 Radar System Test Panel facilitates testing, alignment, and troubleshooting of the Bendix RDR-1F Weather Radar System. The Test Panel assists in determining the operational status of any unit of an RDR-1F Radar System. The ASI-154-1 is comparable to the complete aircraft radar wiring harness and, in conjunction with standard shop test equipment, allows one unit at a time to be tested by substitution with a known serviceable unit.

The ASI-154-1 includes test interconnect cables for the Antenna, Indicator, and R/T. A user supplied Radar Control (CON-1R/1S) is required for proper operation of the test panel. The control mounts directly on the front panel of the ASI-154-1 and can be easily interchanged with other controls as required during testing.

Test panels designed to test each unit of the RDR-1F Weather Radar System individually are also available from Avionics Specialist, Inc. These test panels are listed in the optional equipment section below.

Equipment Supplied:

ASI MN	OEM PN	Description
ASI-15-4A	2038350-0501	Cable, ASI-154-1 to RDR-1F (W101)
ASI-15-4B	2038351-0501	Cable, ASI-154-1 to PPI-1L (W102)
ASI-15-4C	2038352-0501	Cable, ASI-154-1 PWR Connector (W103)
ASI-15-4D	2038352-0501	Cable, ASI-154-1 to ANT-1T (W104)

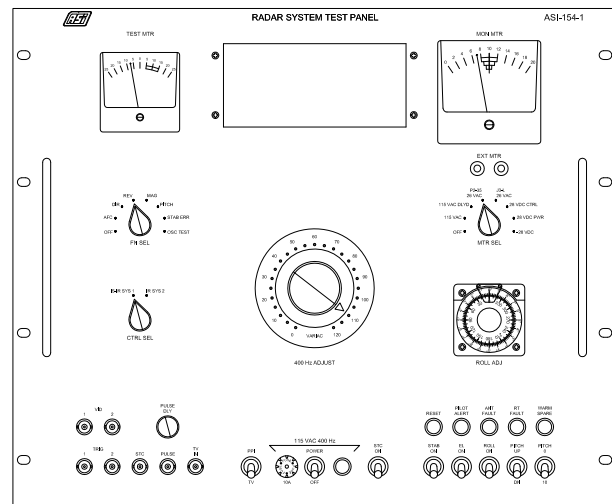

Units Tested:

RDR-1F CON-1R
 ANT-1T CON-1S
 PPI-1L

Specifications:

Height: 15.75" Width: 19.00" Depth: 17.00"
 Power Requirements: 115 VAC 400 Hz

Optional Equipment:

ASI MN	OEM PN	Description
ASI-152-1	2038139-0501	RDR-1F Radar Test Panel (RDT-1F)
ASI-153-1	2038070-0501	ANT-1T Radar Ant Test Panel (ATT-1F)
ASI-174	2038141-0501	PPI-1 Radar Indicator Test Panel (PPT-1B)

RDR-1FB Radar System Test Panel

ASI-154-2

OEM Equivalent:

OEM: Bendix
 Model Number: RCT-1FB
 Part Number: 2041349-0102
 Manual: I.B. 1103CT-1 / 34-43-10
 Manual Figure: 1

This unit is manufactured to replace the OEM MN, PN, and/or manual figure listed in Form, Fit, and Function.

Description:

The ASI-154-2 Radar System Test Panel facilitates testing, alignment, and troubleshooting of the Bendix RDR-1FB Weather Radar System. The Test Panel assists in determining the operational status of any unit of an RDR-1FB Radar System. The ASI-154-2 is comparable to the complete aircraft radar wiring harness and, in conjunction with standard shop test equipment, allows one unit at a time to be tested by substitution with a known serviceable unit. The ASI-154-2 also includes circuitry and wiring required to test RDR-1FB(M) Radar Systems with sector scan and variable STC capability.

The ASI-154-2 includes test interconnect cables for the Antenna, Indicator, and R/T. A user supplied Radar Control (CON-1RB/1SB) is required for proper operation of the test panel. The control mounts directly on the front panel of the ASI-154-2 and can be easily interchanged with other controls as required during testing.

Test panels designed to test each unit of the RDR-1FB Weather Radar System individually are also available from Avionics Specialist, Inc. These test panels are listed in the optional equipment section below.

Equipment Supplied:

ASI MN	OEM PN	Description
ASI-15-42A	8056346-0501	Cable, ASI-154-2 to RDR-1FB/TB (W101)
ASI-15-42B	2041574-0502	Cable, ASI-154-2 to PPI-1TB (W102)
ASI-15-42C	2038352-0502	Cable, ASI-154-2 PWR Connector (W103)
ASI-15-42D	2038353-0502	Cable, ASI-154-2 to ANT-1TB (W104)
ASI-15-42E	8056342-0501	Cable, ASI-154-2 to CON-TB (W105)

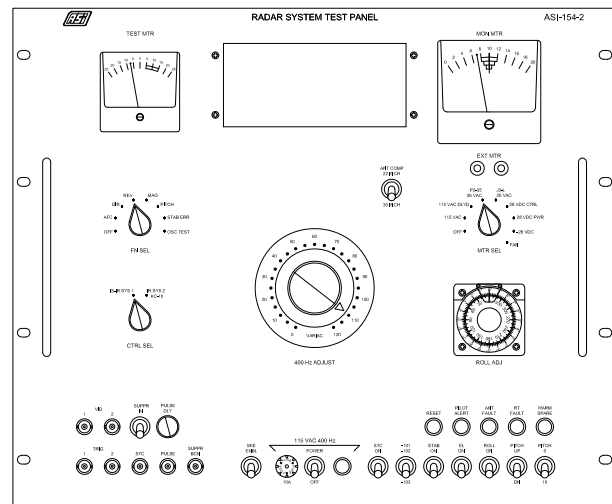

Units Tested:

RTA-1TB / RTA-1FB / RTA-1FB(M)
 ANT-1TB / ANT-1TB(M)
 CON-1RB / CON-1SB / CON-1SB(M) / CON-1TB(M)
 PPI-1TB / PPI-1TB(M)

Specifications:

Height: 15.75" Width: 19.00" Depth: 17.00"
 Power Requirements: 115 VAC 400 Hz

Optional Equipment:

ASI MN	OEM PN	Description
ASI-152-2	2038139-0501	RDR-1FB Radar Test Panel (RDT-1FB)
ASI-153-2	2038270-0502	ANT-1TB Radar Ant Test Panel (ATT-1FB)
ASI-244-1	2041350-0101	PPI-1FB Radar Ind Test Panel (PPT-1FB)
ASI-252-1	2041348-0102	CON-1RB/1SB Control Test Panel (COT-1FB)

R2

Universal Digital Interface Test Set

ASI-155

OEM Equivalent: Honeywell / Sperry
 MN:
 PN: 7010569-901
 Manual Figure:
 IB8029081 / 34-40-14 / Fig. 9004

UUT: Primus Digital Indicators
 (See UUT List Below)
 Size: H: 3.25" W: 8.00" D: 6.50"
 Pwr: 115 VAC 50-400Hz

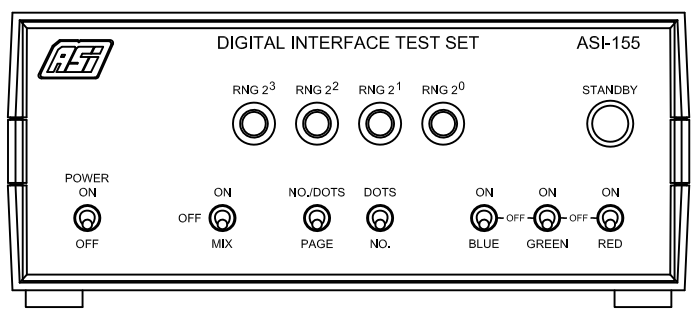

Description:
 The ASI-155 Universal Digital Interface (UDI) Test Set tests the operation of the UDI functions in Honeywell / Sperry Primus Digital Indicators. Testing is accomplished by providing simulated checklist and navigational information to be displayed on the indicator. The ASI-155 includes 3 cables that allow testing of any Primus Digital Indicator with a UDI connector (J102).

See the Optional Equipment section for additional test fixtures and cables that may be required for testing various Primus Weather Radar Systems.

- UUT List:**
- | Type |
|--|
| DI-1007 / MI585438/MI585438-1 |
| DI-1008 / MI585439/MI585439-1 |
| DI-2006 / MI585210-6/MI585210-7/MI585210-8/MI585210-9 |
| DI-2007 / MI585277/MI585277-1/MI585277-4/MI585277-5 |
| DI-2008 / MI585277-2/MI585277-3 |
| DI-3001 / MI585223/MI585223-1/MI585223-2/MI585223-3 |
| DI-4001 / MI585201/MI585201-1/MI585201-2/MI585201-3 |
| DI-4002 / MI585343/MI585343-1 |
| DI-5001 / MI585301/MI585301-1 |
| DI-9001 / MI585162-2/MI585162-3/MI585162-4/MI585162-5 |
| DI-9002 / MI585162-6 |
| DI-9004 / MI585162-7 |
| WI-440 / WI-450 |
| WI-650 / WI-660 |
| WI-800 / MI585351/MI585351-1/MI585351-2/MI585351-3/MI585352/MI585352-1 |
| WI-870 / WI-880 |

Equipment Supplied:

ASI MN	OEM PN	Description
ASI-15-5A	NPN	Cable, ASI-155 to UDI Conn (2DE-19SBRP)
ASI-15-5B	NPN	Cable, ASI-155 to UDI Conn (14-19S)
ASI-15-5C	NPN	Cable, ASI-155 to UDI Conn (14-33S)

Optional Equipment:

ASI MN	OEM PN	Description
ASI-163	NPN	Primus Radar System Test Panel
ASI-263	T334612	Primus 450/650/870 Test Panel (HWX-650/870)
ASI-263-2	T336162	Primus 331/440/660/880 Test Panel (HWX-660/880)
ASI-266	T334714	Primus 800 Test Panel (HWX-800)
ASI-266-2	7015455-901	Primus 700/701 Test Panel (HWX-700)
ASI-266-2A	T337333	Primus 700/700A/701/701A Test Panel (HWX-700A)

Universal High Pot Tester

ASI-158

OEM Equivalent: Rockwell Collins
 MN:
 PN: 637-7656-001
 Manual Figure:
 523-0773830 / 22-12-18 / Fig. 921
 523-0777073 / 22-12-74 / Fig. 917

UUT: BCA-770
 SVO-1000
 Size: H: 10.50" W: 19.00" D: 17.00"
 Pwr: 115 VAC 60Hz

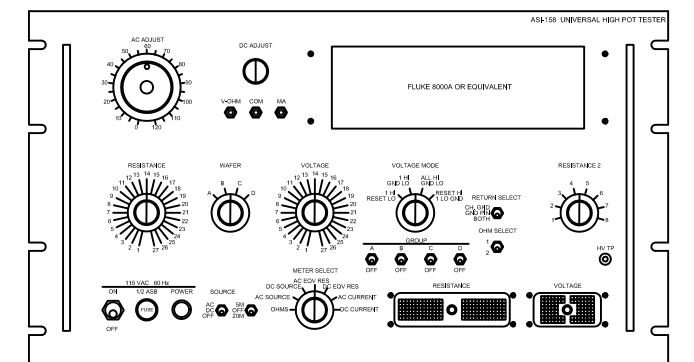

Description:
 The ASI-158 Universal High Pot Tester provides monitoring of voltage, current, and resistance during testing of various Rockwell Collins servos and actuators. The ASI-158 also provides dielectric and over potential testing.

The ASI-158 is identical to the ASI-158-1 except for the power input requirements.

A user supplied digital multi-meter (Fluke 8010A or equivalent) must be installed in the tester for proper operation. Test cables required to interconnect the unit being tested to the tester are listed in the optional equipment section.

Equipment Supplied:

ASI MN	OEM PN	Description
ASI-15-8A	867-9993-001	Cable, ASI-158 to SVO-1000
ASI-15-8B	830-2523-001	Cable, ASI-158 to BCA-770
ASI-403-2	622-7122-002	SVO Servo Test Panel (972S-5)
ASI-404-1	676-3923-001	BCA Servo Test Panel

Optional Equipment:

ASI MN	OEM PN	Description
ASI-15-8A	867-9993-001	Cable, ASI-158 to SVO-1000
ASI-15-8B	830-2523-001	Cable, ASI-158 to BCA-770
ASI-403-2	622-7122-002	SVO Servo Test Panel (972S-5)
ASI-404-1	676-3923-001	BCA Servo Test Panel

Universal High Pot Tester

ASI-158-1

OEM Equivalent: Rockwell Collins
 MN:
 PN: 637-7656-100
 Manual Figure:
 523-0773830 / 22-12-18 / Fig. 921
 523-0777073 / 22-12-74 / Fig. 917

UUT: BCA-770
 SVO-1000
 Size: H: 10.50" W: 19.00" D: 17.00"
 Pwr: 115 VAC 400Hz

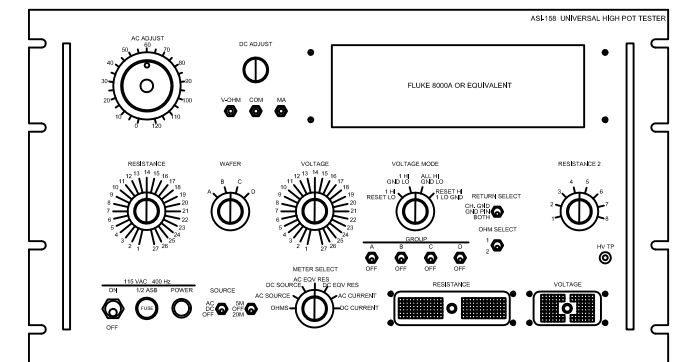

Description:
 The ASI-158-1 Universal High Pot Tester provides monitoring of voltage, current, and resistance during testing of various Rockwell Collins servos and actuators. The ASI-158-1 also provides dielectric and over potential testing.

The ASI-158-1 is identical to the ASI-158 except for the power input requirements.

A user supplied digital multi-meter (Fluke 8010A or equivalent) must be installed in the tester for proper operation. Test cables required to interconnect the unit being tested to the tester are listed in the optional equipment section.

Equipment Supplied:

ASI MN	OEM PN	Description
ASI-15-8A	867-9993-001	Cable, ASI-158 to SVO-1000
ASI-15-8B	830-2523-001	Cable, ASI-158 to BCA-770
ASI-403-2	622-7122-002	SVO Servo Test Panel (972S-5)
ASI-404-1	676-3923-001	BCA Servo Test Panel

Optional Equipment:

ASI MN	OEM PN	Description
ASI-15-8A	867-9993-001	Cable, ASI-158 to SVO-1000
ASI-15-8B	830-2523-001	Cable, ASI-158 to BCA-770
ASI-403-2	622-7122-002	SVO Servo Test Panel (972S-5)
ASI-404-1	676-3923-001	BCA Servo Test Panel

Deluxe Universal Heading and Track Selector

ASI-160B

OEM Equivalent: MN: NMN PN: NPN Manual: Manual Figure:	UUT: Various Avionics Size: H: 3.50" W: 19.00" D: 13.00" Pwr: From UUT
--	--

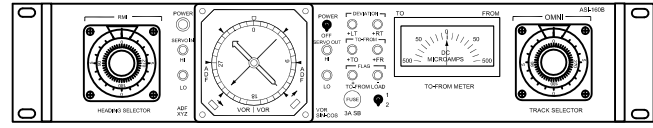

Description:
The ASI-160B facilitates calibration of both "manual" and "automatic" VOR converters, the VOR section of RNAV units, and when used in conjunction with a control/interface panel will allow monitoring of the deviation and flag current outputs. A To-From meter is built into the unit. The OBS resolver is capable of both EZ (400 Hz) and ORZ (30 Hz) output.

The ASI-160B requires a user supplied RMI (332C-10 / KNI-581) for operation.

Equipment Supplied:

ASI MN	OEM PN	Description
	DA-15S	Mating Connector
	DB-25S	Mating Connector

Optional Equipment:

ASI MN	OEM PN	Description
ASI-16-B1	NPN	Cable, ASI-160B/C to KNI-582
ASI-16-B2	NPN	Cable, ASI-160B/C to RMI-36
ASI-16-B3	NPN	Cable, ASI-160B/C to Linaire LV-5
ASI-16-B4	NPN	Cable, 479V-3 Mating Adapter
ASI-16-B5	NPN	Cable, ASI-160B/C to 977A-1 TB-2
ASI-16-B6	NPN	Cable, ASI-160B/C to Linaire LV-6
ASI-215	NPN	Synchro/Resolver/CT Test Panel

Universal Heading and Track Selector with Meters

ASI-160C

OEM Equivalent: MN: NMN PN: NPN Manual: Manual Figure:	UUT: Various Avionics Size: H: 5.25" W: 19.00" D: 13.00" Pwr: From UUT
--	--

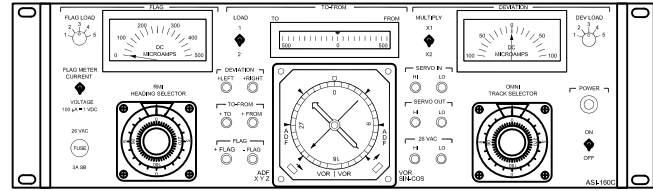

Description:
The ASI-160C facilitates calibration of both "manual" and "automatic" VOR converters and the VOR section of RNAV units. The test panel has built in meters to monitor the Deviation, Flag, and To-From outputs. The OBS resolver is capable of both EZ (400 Hz) and ORZ (30 Hz) output. The ASI-160C combines all of the features of both the ASI-160B and ASI-190B into one test panel.

The ASI-160C requires a user supplied RMI (332C-10 / KNI-581) for operation.

Equipment Supplied:

ASI MN	OEM PN	Description
	DA-15S	Mating Connector
	DB-25S	Mating Connector

Optional Equipment:

ASI MN	OEM PN	Description
ASI-16-B1	NPN	Cable, ASI-160B/C to KNI-582
ASI-16-B2	NPN	Cable, ASI-160B/C to RMI-36
ASI-16-B3	NPN	Cable, ASI-160B/C to Linaire LV-5
ASI-16-B4	NPN	Cable, 479V-3 Mating Adapter
ASI-16-B5	NPN	Cable, ASI-160B/C to 977A-1 TB-2
ASI-16-B6	NPN	Cable, ASI-160B/C to Linaire LV-6
ASI-215	NPN	Synchro/Resolver/CT Test Panel

Universal Precision Track Selector

ASI-161

OEM Equivalent: Rockwell Collins MN: 479V-3 PN: 522-1339-000 Manual: 520-5928000 Manual Figure: 1	UUT: Various Avionics Size: H: 3.50" W: 19.00" D: 5.50" Pwr: From UUT
---	---

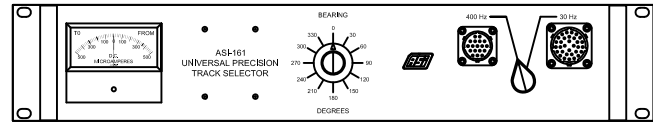

Description:
The ASI-161 facilitates calibration of both "manual" and "automatic" VOR converters and the VOR section of RNAV units. The test panel has a built in meter to monitor the To-From output. The ASI-161 provides stable and accurate omnibearing selector signals in 30° increments and can be used with either EZ (400 Hz) and ORZ (30 Hz) resolver systems.

See the ASI-190 for a Track Selector that is functionally equivalent to the 479V-3 but that will allow omnibearing selection in 0.2° increments.

Equipment Supplied:

ASI MN	OEM PN	Description
ASI-166A	NPN	Test Fixture for ASI-161 / 479V-3 / 79V (479V-3 Manual Figure 10)

Optional Equipment:

ASI MN	OEM PN	Description
ASI-166A	NPN	Test Fixture for ASI-161 / 479V-3 / 79V (479V-3 Manual Figure 10)

714E-1/2/3/6 Control Test Panel

ASI-162

OEM Equivalent: Rockwell Collins MN: NMN PN: NPN Manual: 520-0759328 / 523-0759269 Manual Figure: 1002-1003 / 1002-1003	UUT: 714E-1 / 714E-2/-2A/-2B/-2C 714E-3/-3B/-3C/-3D/-3F/-3G/-3H 714E-6/-6A/-6B Size: H: 3.50" W: 19.00" D: 5.00" Pwr: 28 VDC
---	--

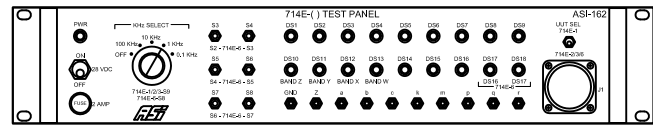

Description:
The ASI-162 facilitates testing of the Collins 714E-1/-2/-3/-6 Radio Set Controls. The test panel includes all test points, lamps, switches, and interconnections required for testing the uut.

The ASI-162 includes four test cables required to interface the various units tested to the test panel.

Equipment Supplied:

ASI MN	OEM PN	Description
ASI-16-2A	NPN	Cable, 714E-1/-2/-2A/-2B/-2C
ASI-16-2B	NPN	Cable, 714E-3/-3B/-3D/-3F/-3H
ASI-16-2C	NPN	Cable, 714E-3C/-3G
ASI-16-2D	NPN	Cable, 714E-6/-6A /-6B

Optional Equipment:

ASI MN	OEM PN	Description
ASI-16-2A	NPN	Cable, 714E-1/-2/-2A/-2B/-2C
ASI-16-2B	NPN	Cable, 714E-3/-3B/-3D/-3F/-3H
ASI-16-2C	NPN	Cable, 714E-3C/-3G
ASI-16-2D	NPN	Cable, 714E-6/-6A /-6B

Primus Radar System Test Panel

ASI-163

OEM Equivalent:

OEM: Sperry (Honeywell)
 Model Number:
 Part Number:
 Manual: I.B.8029066
 Manual Figure: 104

This unit is manufactured to replace the OEM MN, PN, and/or manual figure listed in Form, Fit, and Function.

Description:

The ASI-163 Primus Radar Test Panel provides power, test points, switching, and interconnection required for testing, alignment, and repair of the Primus-40/-90/-300/-400/-500 Radar Systems. The ASI-163 includes a built in gyro simulator thus eliminating the need for an external simulator.

Accessory equipment and cables required for testing each Primus system component are listed in the Optional Equipment section below.

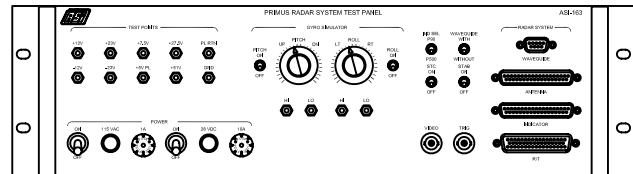

Equipment Supplied:

ASI MN	OEM PN	Description
--------	--------	-------------

Optional Equipment:

ASI MN	OEM PN	Description
ASI-16-3A	NPN	Cable: ASI-163 to Primus-90 R/T
ASI-16-3B	NPN	Cable: ASI-163 to Primus-90 Indicator
ASI-16-3C	NPN	Cable: ASI-163 to Primus-90 Antenna
ASI-16-3D	NPN	Cable: ASI-163 to Primus 90 W/G Switch
ASI-16-3E	NPN	Cable: ASI-163 to P40/300/400/500 R/T
ASI-16-3F	NPN	Cable: ASI-163 to P40/300/400/500 Indicator
ASI-16-3G	NPN	Cable: ASI-163 to P40/300/400/500 Antenna
ASI-16-3H	NPN	Test Set: Primus R/T Mag Current/AFC
ASI-16-3J	NPN	Cable: Primus R/T Stabilization Adapter
ASI-155	NPN	Test Set: Primus Indicator Digital Interface

Units Tested:

PRIMUS 40
 PRIMUS 90 (AP9001 / DI9001 / DI9002 / DI9003 / DI9004 / P90RT)
 PRIMUS 300 (AP3001 / DI3003 / RT3002)
 PRIMUS 300SL (AP3001 / DI2007 / RT3002)
 PRIMUS 400 (AP4001 / DI4001 / RT4001)
 PRIMUS 400SL (AP4001 / DI4002 / RT4001)
 PRIMUS 500 (AP5001 / DI5001 / RT5001)

Specifications:

Height: 5.25" Width: 19.00" Depth: 6.00"
 Power Requirements: 28 VDC / 115 VAC 400 Hz

Radio Altimeter Indicator Test Panel

ASI-164

OEM Equivalent:

OEM: Rockwell Collins
 Model Number:
 Part Number:
 Manual: 523-0758818 / 523-0759413 / 523-0770457
 Manual Figure: 1002E (TR17) / 1002E (TR16) / 902A (TR3)

This unit is manufactured to replace the OEM MN, PN, and/or manual figure listed in Form, Fit, and Function.

Description:

The ASI-164 Radio Altimeter Indicator Test Panel provides a convenient, self-contained means of aligning, testing and troubleshooting the Rockwell Collins 339H-1/-2/-5/-6 and Bendix (Honeywell) INA-51 series of Radio Altimeter Indicators. The ASI-164 combines the test fixtures shown in the 339H-() maintenance manuals with all the power supplies and meters required for testing the Indicators. The test outputs normally supplied by the Bendix ALT-51A Test Panel are also provided in order to test the INA-51 indicators.

The Test Panel requires specific test cables (ASI-16-4x) for each indicator. These cables are listed in the Optional Equipment section below.

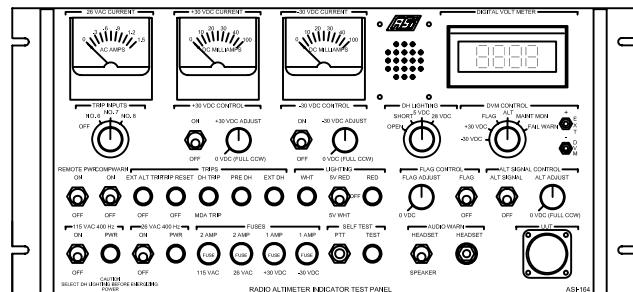

Units Tested:

339H-1 / 339H-1A / 339H-1B / 339H-1C / 339H-1D
 339H-2
 339H-5
 339H-6
 INA-51A / INA-51B / INA-51D / INA-51V

Equipment Supplied:

ASI MN	OEM PN	Description
--------	--------	-------------

Optional Equipment:

ASI MN	OEM PN	Description
ASI-16-4A	NPN	Cable: 339H-1(), 339H-2 (-001), 339H-6 (-001)
ASI-16-4B	NPN	Cable: 339H-2 / 339H-6 (Except 339H-2/6 -001)
ASI-16-4C	NPN	Cable: 339H-5
ASI-16-4D	NPN	Cable: INA-51A / INA-51B / INA-51D / INA-51V
ASI-25-8A	NPN	339H-6 Main Extender Cable
ASI-25-8B	NPN	339H-6 Power Supply Extender Cable
ASI-25-9A	647-6485-003	339H-6 Servo Assy Pin No. 3
ASI-25-9B	647-6485-004	339 H-6 Servo Assy Pin No. 4
ASI-259-L	NPN	Tape Winding Fixture - Left
ASI-259-R	NPN	Tape Winding Fixture - Right

Specifications:

Height: 8.75" Width: 19.00" Depth: 10.00"
 Power Requirements: 115 VAC 400 Hz

Synchro Source

ASI-165

OEM Equivalent:

OEM: Rockwell Collins
 Model Number: CSS-10
 Part Number: 622-5330-001
 Manual: 523-0770399
 Manual Figure: 1-1

This unit is manufactured to replace the OEM MN, PN, and/or manual figure listed in Form, Fit, and Function.

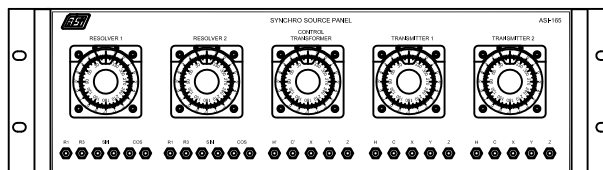

Description:

The ASI-165 Synchro Source is a signal simulator that provides synchro control transformer, dual transmitter, and dual resolver outputs. These signals would normally be derived from the gyrocompass or other components of the integrated flight system.

The ASI-165 is used in the testing of attitude director indicators, horizontal situation indicators, course indicators, and other avionics equipment requiring synchro / resolver signals.

Units Tested:

Various Avionics

Specifications:

Height: 5.25" Width: 19.00" Depth: 6.00"
 Power Requirements: From UUT

Equipment Supplied:

ASI MN	OEM PN	Description
	MS3126F18-32S	Mating Connector, M/W J100
	XAC14PC1A306	Mating Connector, M/W J101

Optional Equipment:

ASI MN	OEM PN	Description
ASI-166	522-0167-001	Resolver Zeroing Panel (479X-2)
ASI-215	NPN	Synchro/Resolver/CT/ Calibration Panel

Resolver Zeroing Panel

ASI-166

OEM Equivalent:

OEM: Rockwell Collins
 Model Number: 479X-2
 Part Number: 522-0167-001
 Manual: 523-5345000
 Manual Figure: 1-1

This unit is manufactured to replace the OEM MN, PN, and/or manual figure listed in Form, Fit, and Function.

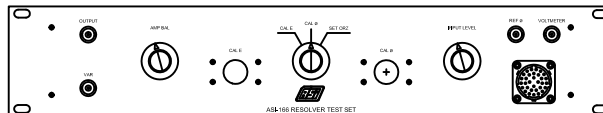

Description:

The ASI-166 Resolver Zeroing Panel provides a means of indexing VOR resolvers. Omnibearing Selectors (OBS) and Omnibearing Indicators (OBI) can be indexed within $\pm 1^\circ$. The ASI-166 permits omniresolver zeroing (ORZ) in accordance with RTCA standards with a minimum of amount of associated equipment (Voltmeter, Oscilloscope, and audio Generator).

The ASI-166 includes OBS cable, 30 Hz Filter and 3 coax cables.

Units Tested:

Various Avionics

Specifications:

Height: 3.50" Width: 19.00" Depth: 4.00"
 Power Requirements: From UUT

Equipment Supplied:

ASI MN	OEM PN	Description
ASI-16-6C	540-7246-000	Cable, ASI-166 to Omnibearing Selector
ASI-16-6D	540-7244-000	30 Hz Filter
ASI-16-6F	506-4851-002	Coax Cable (Qty 2)
ASI-16-6G	540-7247-000	Voltmeter Cable

Optional Equipment:

ASI MN	OEM PN	Description
ASI-16-6A	540-7245-000	Cable, ASI-166 to Omnibearing Indicator
ASI-16-6B	NPN	Cable, ASI-166 to ASI-150 / -150() / -190()
ASI-16-6E	NPN	Cable, ASI-166 to FMC-28 / -28A (ORZ)

Synchro Simulator

ASI-167

OEM Equivalent:

OEM: Rockwell Collins
 Model Number: 978F-2S
 Part Number: 522-3498-000
 Manual: 523-0756721
 Manual Figure: 1-1

This unit is manufactured to replace the OEM MN, PN, and/or manual figure listed in Form, Fit, and Function.

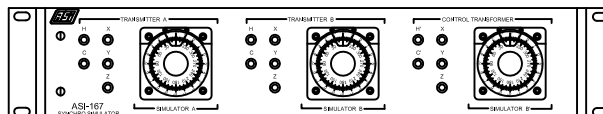

Description:

The ASI-167 Synchro Simulator is a signal simulator that provides synchro control transformer and dual transmitter outputs. These signals would normally be derived from the gyrocompass or other components of the integrated flight system.

The ASI-167 is used in the testing of attitude director indicators, horizontal situation indicators, course indicators, and other avionics equipment requiring synchro signals.

Units Tested:

Various Avionics

Specifications:

Height: 3.50" Width: 19.00" Depth: 15.00"
 Power Requirements: From UUT

Equipment Supplied:

ASI MN	OEM PN	Description
	XAC14PC1A306X	Mating Connector, M/W J1

Optional Equipment:

ASI MN	OEM PN	Description
ASI-215	NPN	Synchro/Resolver/CT/ Calibration Panel

332D-11 Gyro Test Panel

ASI-168

OEM Equivalent: Collins
 MN:
 PN:
 Manual: 523-0757989
 Manual Figure: 1002-1004

UUT: 332D-11 / 332D-11A / 332D-11B
 332D-11T / 332D-11V

Size: H: 7.00" W: 19.00" D: 17.25"
 Pwr: 115 VAC 400 Hz

Description:

The ASI-168 Gyro Test Panel provides the functions required to test, align, and repair the Collins 332D-11() series of vertical gyro's. The Test Panel includes interconnection, switching, test points, and the angle position indicator (SR-103 or equivalent) that is required to monitor the pitch and roll outputs from the gyro.

The 332D-11() interface cable (ASI-16-8A) is included with the ASI-168 Test Panel.

Optional fixtures required for testing the Collins 332D-11() are listed in the Optional Equipment section at the bottom of this page.

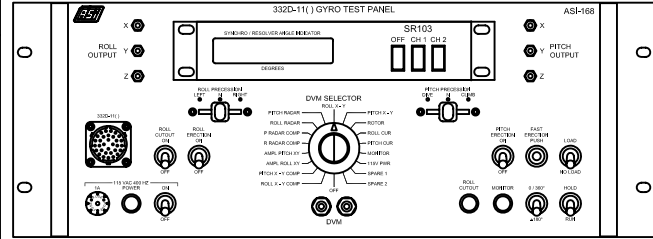

Equipment Supplied:

ASI MN	OEM PN	Description
ASI-16-8A	NPN	Cable, ASI-168 to 332D-11()
SR-103*	NPN	Angle Position Indicator (Installed in Test Set)

* An equivalent API may be substituted for the SR-103.

Optional Equipment:

ASI MN	OEM PN	UUT MANUAL FIGURE	Description
ASI-16-8B	NPN	332D-11() Fig. 1021	Rotor End Cap Puller
ASI-16-8C1	NPN	332D-11() Fig. 1018	Rotor Plug Spanner Wrench
ASI-16-8C2	NPN	332D-11() Fig. 1019	Pivot Spanner Wrench
ASI-16-8D	NPN	332D-11() Fig. 1020	Rotor End Cap Press and Base Tool
ASI-16-8E1	NPN	332D-11() Fig. 1022	Bearing Remover
ASI-16-8E2	NPN	332D-11() Fig. 1023	Bearing Press Tool
ASI-16-8E3	NPN	332D-11() Fig. 1023	Base Tool
ASI-16-8E4	NPN	332D-11() Fig. 1023	Oil Retaining Press Tool
ASI-16-8E5	NPN	332D-11() Fig. 1024	Arbor Holder Plate
ASI-16-8F	NPN	332D-11() Fig. 1025	Balance Machine Gyro Mounting Adapter (Gyros Without SB 26)
ASI-16-8G	NPN	332D-11() Fig. 1026	Gisholt HS-2 Balance Machine Adapter
ASI-16-8H	NPN	332D-11() Fig. 1027	Balance Machine Gyro Mounting Adapter (Gyros With SB 26)
ASI-16-8I	NPN	332D-11() Fig. 1028	Drilling Unit Adapter
ASI-16-8J	NPN	332D-11() Fig. 1029	Brush Adjustment Tool
ASI-16-8K	NPN	332D-11() Fig. 1030	Brush Tension Gage
ASI-16-8L	NPN	332D-11() Fig. 1031	Dial Indicator Mounting Post
ASI-16-8M	NPN	332D-11() Fig. 1032	End Play Adjustment Spacer (2 Required)
ASI-16-8N1	NPN	332D-11() Fig. 1033	Torque Stator Cementing Fixture
ASI-16-8N2	NPN	332D-11() Fig. 1034	Ring Assembly Cementing Fixture
ASI-16-8N3	NPN	332D-11() Fig. 1035	Solenoid Plunger Cementing Fixture
ASI-16-8O	NPN	332D-11() Fig. 1036	Test Cover
ASI-16-8P	NPN	332D-11() Fig. 1037	Wooden Block
ASI-16-8Q1	NPN	332D-11() Fig. 1039	Gyro Run In Fixture for Units Without SB 26
ASI-16-8Q2	NPN	332D-11() Fig. 1040	Bonding/Run In Fixture for Units With SB 26
ASI-16-8Q3	NPN	332D-11() Fig. 1041	Gyromotor Run In Fixture
ASI-16-8R	NPN	332D-11() Fig. 1042	Epoxy Application Tool
ASI-16-8S	NPN	332D-11() Fig. 1043	Bearing Race Cleaning Fixture
ASI-16-8T1	NPN	332D-11() Fig. 1044	Bearing Bonding Weight
ASI-16-8T2	NPN	332D-11() Fig. 1045	Rotor End Cap / Bearing Bonding Fixture
ASI-16-8U	NPN	332D-11() Fig. 1046	Calibrated Gyromotor Rotor
ASI-16-8V	NPN	332D-11() Fig. 1047	Modified Drill Bit
ASI-16-8W	NPN	332D-11() Fig. 1048	Preload Sleeve Remover
ASI-16-8W1	NPN	332D-11() Fig. 1049	Rotor Disassembly Tools
ASI-16-8W2	NPN	332D-11() Fig. 1050	Mount Installation Base Tool No 1
ASI-16-8W3	NPN	332D-11() Fig. 1051	Mount Installation Flaring Tool No 1
ASI-16-8W4	NPN	332D-11() Fig. 1052	Mount Installation Base Tool No 2
ASI-16-8W5	NPN	332D-11() Fig. 1053	Mount Installation Flaring Tool No 2
ASI-16-8X	NPN	332D-11() Fig. 1054	Arbor Press Punch Tool
ASI-16-8Y1	NPN	332D-11() Fig. 1055	Dial Indicator Mounting Post Inspection No 1 Tool
ASI-16-8Y2	NPN	332D-11() Fig. 1055	Dial Indicator Mounting Post Inspection No 2 Tool
ASI-16-8Y3	NPN	332D-11() Fig. 1055	Dial Indicator Mounting Post Inspection No 3 Tool
ASI-16-8Y4	NPN	332D-11() Fig. 1056	Dial Indicator Mounting Post Check No 1 Tool
ASI-16-8Y5	NPN	332D-11() Fig. 1056	Dial Indicator Mounting Post Check No 2 Tool
ASI-16-8Z1	NPN	332D-11() Fig. 1057	Press Adapter Plate (For Dake Model 0)
ASI-16-8Z2	NPN	332D-11() Fig. 1058	Gyromotor Support Fixture (Use with Dake Model 0)
ASI-168-1	NPN	332D-11() FIG 1006, 1008-1010	Noise Test Panel (Includes Sample of Hold Circuit)

Portable Stabilization Test Set

ASI-169

OEM Equivalent:
 OEM: Bendix
 Model Number: RST-1A
 Part Number: 2064746-0501
 Manual: I.B. 1101ST
 Manual Figure: 1

This unit is manufactured to replace the OEM MN, PN, and/or manual figure listed in Form, Fit, and Function.

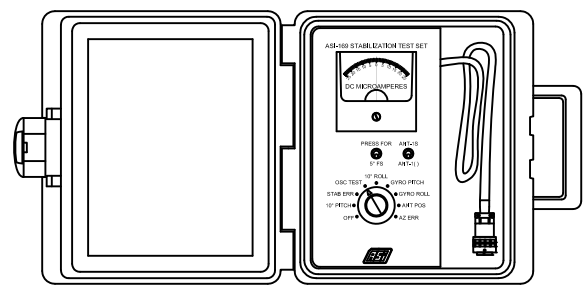

Description:

The ASI-169 Stabilization Test Set facilitates testing and adjustment of the antenna stabilization circuits in the Bendix RDR-1E/ED Weather System. The unit is portable and derives all of its input power and test signals from the connector located on the front of the RDR-1E/ED Receiver-Transmitter.

The ASI-169 is intended to be used primarily as a ramp test set to optimize the stabilization gain adjustments to a given antenna in a given aircraft. The ASI-169 is enclosed in a rugged plastic case.

Units Tested:
 RDR-1E/1ED Weather Radar System

Specifications:
 Height: 8.00" Width: 8.50" Depth: 4.00"
 Power Requirements: From UUT

Equipment Supplied:

ASI MN	OEM PN	Description
ASI-16-9A	2034816-0001	Test Procedure Placard, ANT-1S
ASI-16-9B	2034816-0002	Test Procedure Placard, ANT-1M/1N/1P
ASI-16-9C	2034816-0003	Test Procedure Placard, ANT-1F/1G

Optional Equipment:

ASI MN	OEM PN	Description
ASI-171	2037736-0501	Radar System Test Panel (RDT-1A)
ASI-172	2037737-0501	Radar Antenna Test Panel (RDT-1B)

Portable Radar Test Set

ASI-169-2

OEM Equivalent:
 OEM: Bendix
 Model Number: RST-4A
 Part Number: 2041797-0401
 Manual: I.B. 1104GT / 34-41-61
 Manual Figure: 1

This unit is manufactured to replace the OEM MN, PN, and/or manual figure listed in Form, Fit, and Function.

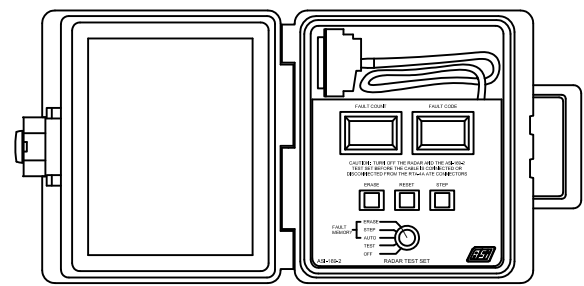

Description:

The ASI-169-2 Portable Radar Test Set interfaces to the ATE connectors of the Bendix RTA-4A Receiver Transmitter for testing purposes.

The Test Set provides the capability of one step and automatic display of all circuit module fault codes stored in the RTA-4A fault memory, starting with the last stored fault code. It provides the ability to erase all stored fault codes and to cut off transmission of fault codes to the PPI during RDR-4A system test. The ASI-169-2 is enclosed in a lightweight, rugged plastic case.

Units Tested:
 RTA-4A / RDR-4A Weather Radar System

Specifications:
 Height: 8.00" Width: 8.50" Depth: 4.00"
 Power Requirements: From UUT

Equipment Supplied:

ASI MN	OEM PN	Description
ASI-16-92A	3611841-0001	Test Procedure Placard, RTA-4A

Optional Equipment:

ASI MN	OEM PN	Description
ASI-742	2041589-0401	Radar System Test Panel (RCT-4A)

Portable Radar Test Set

ASI-170

OEM Equivalent:
 OEM: Bendix
 Model Number: RFT-1A
 Part Number: 2038142-0501
 Manual: I.B. 1102AT / 34-42-51
 Manual Figure: 1

This unit is manufactured to replace the OEM MN, PN, and/or manual figure listed in Form, Fit, and Function.

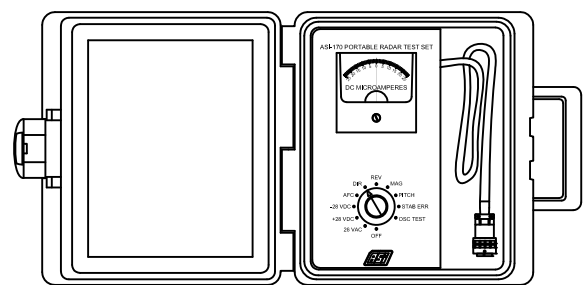

Description:

The ASI-170 Portable Radar Test Set facilitates testing of the Bendix RDR-1F Weather Radar System. The Test Set may be used as a ramp unit for initial installation checkout or as a shop bench test unit for performing fault isolation test procedures on the R/T unit.

All necessary input power and signals are received from the test connector located on the front panel of the RDR-1F Receiver-Transmitter unit. The ASI-170 is enclosed in a lightweight, rugged plastic case.

Units Tested:
 RDR-1F Weather Radar System

Specifications:
 Height: 8.00" Width: 8.50" Depth: 4.00"
 Power Requirements: From UUT

Equipment Supplied:

ASI MN	OEM PN	Description
ASI-17-0A	2035426-0002	Test Procedure Placard

Optional Equipment:

ASI MN	OEM PN	Description
ASI-171	2037736-0501	Radar System Test Panel (RDT-1A)

RDR-1 Radar System Test Panel

ASI-171

OEM Equivalent:

OEM: Bendix
 Model Number: RDT-1A
 Part Number: 2037736-0501
 Manual: I.B. 1101AT
 Manual Figure: 1

This unit is manufactured to replace the OEM MN, PN, and/or manual figure listed in Form, Fit, and Function.

Description:

The ASI-171 Radar System Test Panel provides a centralized means for testing the receiver-transmitter, synchronizer and indicator of the Bendix RDR-1() Weather Radar Systems prior to the RDR-1F Radar System.

The ASI-171 contains circuitry for simulating the antenna and control panel, thus eliminating the need for these units on the test bench.

The ASI-171 includes three interconnect cables and a load box required for testing.

Associated test panels designed to test the RDR-1() Radar System are listed in the optional equipment section.

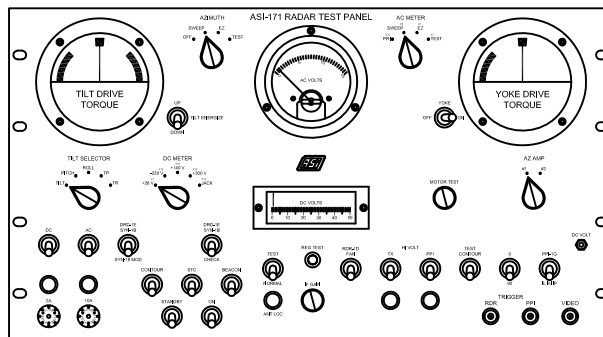

Units Tested:

RDR-1E	PPI-1D	PPI-1E-2	PPI-1M
RDR-1ED	PPI-1E	PPI-1G	PPI-1P
SYN-1B	PPI-1E-1	PPI-1GT	

Specifications:

Height: 10.50" Width: 19.00" Depth: 13.00"
 Power Requirements: 115 VAC 400 Hz / 27.5 VDC

Equipment Supplied:

ASI MN	OEM PN	Description
ASI-17-1A	2036958-0501	Cable, ASI-171 to RDR-1() (W1)
ASI-17-1B	2036957-0501	Cable, ASI-171 to PPI-1() (W2)
ASI-17-1C	2036959-0501	Cable, ASI-171 to SYN-1B (W3)
ASI-17-1D	NPN	Load Box, RDR/PPI (A1)

Optional Equipment:

ASI MN	OEM PN	Description
ASI-169	2064746-0501	Portable Stabilization Test Set (RST-1A)
ASI-172	2037737-0501	Radar Test Panel (RDT-1B)
ASI-173	2037738-0501	Radar Indicator Test Panel (PPT-1A)
ASI-174	2038141-0501	Radar Indicator Test Panel (PPT-1B)

Radar Test Panel

ASI-172

OEM Equivalent:

OEM: Bendix
 Model Number: RDT-1B
 Part Number: 2037737-0501
 Manual: I.B. 1101BT
 Manual Figure: 1

This unit is manufactured to replace the OEM MN, PN, and/or manual figure listed in Form, Fit, and Function.

Description:

The ASI-172 Radar Test panel tests the operational functions of the Bendix CON-1 Radar Control and the ANT-1 Radar Antenna, with the exception of the antenna's RF performance.

The ASI-172 test functions are determined by a combination of front panel switches. A variac allows the user to adjust the proper test voltages. The test panel also features a dual tuning eye which indicates synchro null and rotation reference condition.

The ASI-172 includes two cables for testing the most common CON-1 Controls and ANT-1 Antennas. Other available cables are listed in the optional equipment area.

Associated test panels designed to test the RDR-1() Radar System are listed in the optional equipment section.

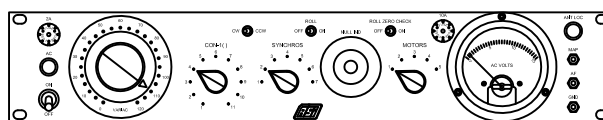

Units Tested:

CON-1A	ANT-1A	ANT-1J
CON-1B	ANT-1B	ANT-1L
CON-1D	ANT-1C	ANT-1M
CON-1J	ANT-1D	ANT-1N
CON-1L	ANT-1E	ANT-1P
CON-1N	ANT-1G	ANT-1S
CON-1NB		

Specifications:

Height: 3.50" Width: 19.00" Depth: 6.00"
 Power Requirements: 115 VAC 400 Hz

Optional Equipment:

ASI MN	OEM PN	Description
ASI-169	2064746-0501	Portable Stabilization Test Set (RST-1A)
ASI-171	2037736-0501	Radar System Test Panel (RDT-1A)
ASI-173	2037738-0501	Radar Indicator Test Panel (PPT-1A)
ASI-174	2038141-0501	Radar Indicator Test Panel (PPT-1B)
ASI-17-2C	2037015-0501	Cable, CON-1A/B/D (W101)
ASI-17-2D	2037017-0501	Cable, CON-1NB (W103)
ASI-17-2E	2037019-0501	Cable, ANT-1G (W202)

Equipment Supplied:

ASI MN	OEM PN	Description
ASI-17-2A	2037016-0501	Cable, CON-1J/L/N (W102)
ASI-17-2B	2037018-0501	Cable, ANT-1A/B/C/D/E/J/L/M/N/P/S (W201)

Radar Indicator Test Panel

ASI-173

OEM Equivalent:

OEM: Bendix
 Model Number: PPT-1A
 Part Number: 2037738-0501
 Manual: I.B. 1101PT
 Manual Figure: 1

This unit is manufactured to replace the OEM MN, PN, and/or manual figure listed in Form, Fit, and Function.

Description:

The ASI-173 Radar Indicator Test Panel facilitates bench testing, alignment, and troubleshooting of the Bendix PPI-1D, PPI-1E-2, PPI-1G, and PPI-1GT Radar Indicators. The test panel is intended to provide a centralized means of conveniently and accurately determining equipment performance with a minimum amount of ancillary test equipment.

The Radar Indicator Test Panel contains circuitry for applying a variety of video signals to the PPI-1(). These include video pulses, system noise, noise bursts, and noise with STC action. Front panel controls facilitate the performance of numerous tests to evaluate the operation of the PPI-1().

The ASI-173 contains the power supply and wave form generator used in a typical RDR-1E Receiver-Transmitter unit. The power supply provides 17.5, 50, 140, 300, and -250 vdc. The 18 vac reference phase voltage and variable control voltage to the drive motor are also generated by the test panel. The wave form generator emits trigger pulses at 200 and 400 Hz and provides the necessary gate voltage for producing noise bursts.

The ASI-173 includes two test cables required for proper operation.

Equipment Supplied:

ASI MN	OEM PN	Description
ASI-17-3A	NPN	Cable, ASI-173 to PPI-1() (W1)
ASI-17-3B	NPN	Cable, ASI-173 PWR (W2)

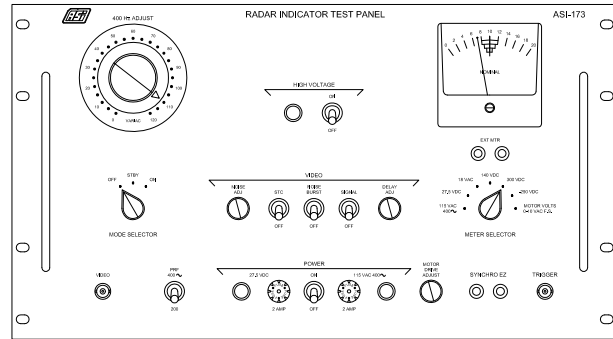

Units Tested:

- PPI-1D
- PPI-1E-2
- PPI-1G
- PPI-1GT

Specifications:

Height: 10.50" Width: 19.00" Depth: 12.75"
 Power Requirements: 115 VAC 400 Hz / 27.5 VDC

Optional Equipment:

ASI MN	OEM PN	Description
--------	--------	-------------

Radar Indicator Test Panel

ASI-174

OEM Equivalent:

OEM: Bendix
 Model Number: PPT-1B
 Part Number: 2038141-0501
 Manual: I.B. 1102DT / 34-42-54
 Manual Figure: 1

This unit is manufactured to replace the OEM MN, PN, and/or manual figure listed in Form, Fit, and Function.

Description:

The ASI-174 Radar Indicator Test Panel provides a convenient, self-contained means for testing, alignment, and troubleshooting the Bendix PPI-1L, PPI-1N, PPI-1P, PPI-1T, and PPI-1U Weather Radar Indicators.

The ASI-174 contains power supply, wave form generator, and azimuth circuitry thus eliminating the need for other system components. Front panel controls facilitate the performance of numerous tests to evaluate the proper operation of the PPI-1().

When used in conjunction with the ASI-743 (AIT-4A) TCAS PPT Adapter Test Panel the ASI-174 has the capability to test TCAS modified PPI-1T and PPI-1U Indicators.

The ASI-174 includes three test cables required for proper operation.

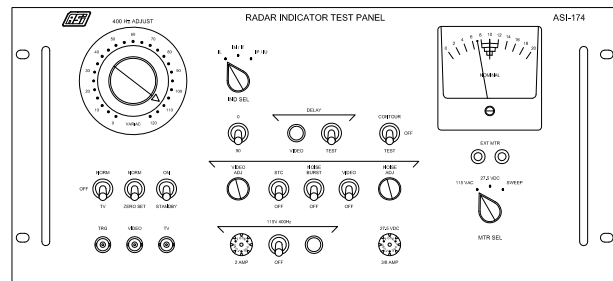

Units Tested:

- PPI-1L
- PPI-1N
- PPI-1P
- PPI-1T
- PPI-1U

Specifications:

Height: 8.75" Width: 19.00" Depth: 9.00"
 Power Requirements: 115 VAC 400 Hz

Optional Equipment:

ASI MN	OEM PN	Description
ASI-17-4A	2038283-0501	Cable: ASI-174 PWR (W101)
ASI-17-4B	2038284-0501	Cable: ASI-174 to PPI-1L/-1N/-1T (W102)
ASI-17-4C	2038816-0501	Cable: ASI-174 to PPI-1P/-1U (W103)
ASI-197	2041323-0101	Radar Test Pattern Generator (PPT-1CG)
ASI-198	2039597-0501	Radar Test Pattern Generator Adapter
ASI-743	8074503-0401	TCAS PPT Adapter Test Panel (AIT-4A)
ASI-76-0C	NPN	Power Supply Load for PPI-1T/-1U/-4B

Equipment Supplied:

ASI MN	OEM PN	Description
ASI-17-4A	2038283-0501	Cable: ASI-174 PWR (W101)
ASI-17-4B	2038284-0501	Cable: ASI-174 to PPI-1L/-1N/-1T (W102)
ASI-17-4C	2038816-0501	Cable: ASI-174 to PPI-1P/-1U (W103)

Portable Altimeter Test Set

ASI-175

OEM Equivalent:

OEM: Bendix
 Model Number: AMT-51A
 Part Number: 2037028-5103
 Manual: I.B. 1151T
 Manual Figure: 1

This unit is manufactured to replace the OEM MN, PN, and/or manual figure listed in Form, Fit, and Function.

Description:

The ASI-175 Portable Altimeter Test Set facilitates rapid testing for various functions of the Bendix ALA-51A altimeter. The Test Set is portable and may be used on the bench or in the aircraft.

The ASI-175 connects to the test plug on the front of the altimeter and quickly evaluates performance of the altimeter by monitoring and interpreting the outputs of various test points. The ASI-175 measures major power supply voltages and overall monitor performance by fault simulation. The Test Set also provides a swept altitude signal to check the operation of the altitude trips, it can initiate the test function, and provides the capability for checking the operation of the ground proximity warning system.

The Test Set is compact, lightweight, and enclosed in a sturdy plastic case. All power required to run the ASI-175 is supplied from the uut.

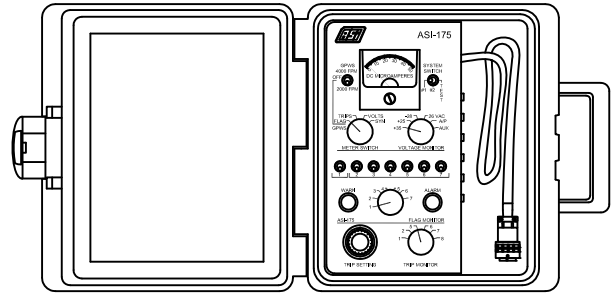

Units Tested:

ALA-51A

Specifications:

Height: 8.00" Width: 8.50" Depth: 4.00"
 Power Requirements: From UUT

Equipment Supplied:

ASI MN	OEM PN	Description
ASI-17-5A	2034175-0002	Test Procedure Placard

Optional Equipment:

ASI MN	OEM PN	Description
ASI-199	2037120-0501	Radio Altimeter Test Panel (ALT-51A)

Portable Altimeter Test Set

ASI-175-2

OEM Equivalent:

OEM: Bendix
 Model Number: AMT-52A
 Part Number: 2041595-5201
 Manual: I.B. 1152BT / 34-42-01
 Manual Figure: 1

This unit is manufactured to replace the OEM MN, PN, and/or manual figure listed in Form, Fit, and Function.

Description:

The ASI-175-2 Altimeter Test Set facilitates the rapid testing of the various functions of the Bendix ALA-52A Radio Altimeter. The Test Set is portable and may be used either on the test bench or inside the aircraft.

The ASI-175-2 is capable of injecting simulated altitude frequencies into three altimeters simultaneously. The modulating frequencies (145, 150, and 155 Hz) of the three altimeters can then be checked individually. The ASI-175-2 is also capable of simulating various rates of aircraft descent.

The ASI-175-2 receives the ARINC 429 altitude words from the altimeter under test and displays decoded altitude, along with the 429 word label and status. The Test Set can be set to read and decode either the binary or BCD 429 word from the altimeter. A functional self-test of the altimeter can be initiated at the test set. Built-in test equipment (BITE) results are displayed on the front panel annunciator.

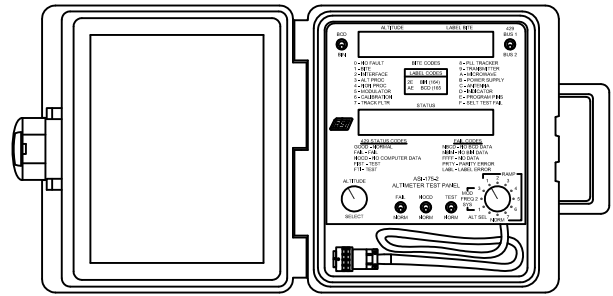

Units Tested:

ALA-52A

Specifications:

Height: 8.00" Width: 8.50" Depth: 4.00"
 Power Requirements: From UUT

Equipment Supplied:

ASI MN	OEM PN	Description
--------	--------	-------------

Optional Equipment:

ASI MN	OEM PN	Description
--------	--------	-------------

DIGITAL DME INDICATOR TEST SET

ASI-176-1 Specifications

Subject to change without notice

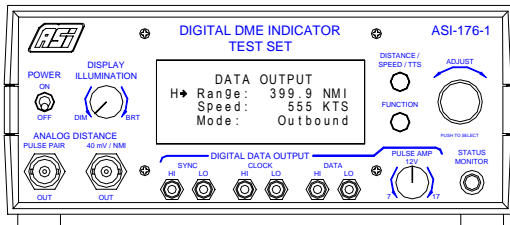

(Front View)

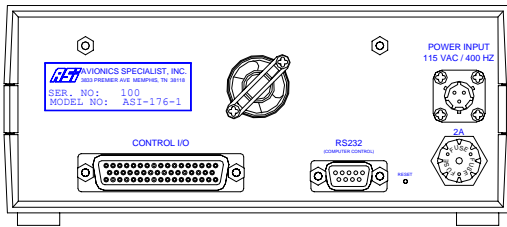

(Rear View)

8.1" Wide x 3.3" High x 6.4" Deep

Description:

Newest to the market, the ASI-176-1 is an updated, modern layout from our ASI-176 series of products. The ASI-176-1 simulates the signals required for functional testing a wide variety of digital DME indicators, R/Ts, and auxiliary equipment. Signal outputs and inputs include ARINC 568, Pulse Pair, Range Rate, 40mV / NMI, ARINC 429, and CSDB.

It is easy to operate with comprehensive control over simulated distance, speed, and test data. Plus, its bright Vacuum-Fluorescent screen can be read in most any lighting condition.

The ASI-176-1 is small and portable weighing 5 pounds and measuring only 8.1" wide, 3.3" high, and 6.4" deep.

Technical Data

Signal Types:	ARINC 568 (6-Wire) Input and Output Pulse-Pair, 1 Input and 1 Output Range Rate, 1 Input and 1 Output 40mV / NMI, 1 Input and 1 Output ARINC 429, 1 Input and 1 Output CSDB, 1 Input and 1 Output
Display Range:	0 to 399.9 NMI for DME and Pulse Pair 0 to 3,999 Nautical Miles for INS
Ground Speed:	0 to 9,999 Knots Inbound/Outbound
ARINC 568 Features:	Input and output bit level label control, Output bits 31 and 32 control, Adjustable digital word rate from 1 to 30 per second, Distance skewed by ground speed control, Received bits view, Output level control from 7V to 17V, 7.5Khz, 11 Khz, and 14.5 Khz output clock rates.
Pulse Pair Features:	Adjustable output rate from 1 to 30 per second, Range from 0 to 399.9 NMI, input resolution to ± 0.1 NMI.
Range Rate Features:	Range from 0 to 9,999 Knots, output at 0.027778 Hz per knot.
40 mV / NMI Features:	Input and Output range from 0 to 339.9 NMI, 12V output reference, Internal/External input reference, accuracy to ± 1 NMI.

*ARINC 429 Features:	Clock bit rates 12.0/12.5/14.5/100 Khz, Word rates from 1ms to 9999ms, Hex and binary display, output levels 10 VDC A to B, full 32 bit output control. *Use of ARINC 429 requires a software upgrade.
**CSDB Features:	12.5 Khz Low Speed, Hex and binary display, RS422 input/output levels, Message Rates at 50ms, 100ms, 200ms, 333ms, or 500ms. **Use of CSDB requires a software upgrade.
Other Features:	Flag output, Decimal Point Inhibit Output, DME Hold Output, Test Output, DME Status Input, Display dim control 25K potentiometer, and custom software available.
Power Input:	115 VAC / 400 Hz, 2 Amps
Power Output:	115 VAC / 400 Hz, 1 Amp 26 VAC / 400 Hz ± 1 VAC, 1 Amp 28 VDC ± 0.5 VDC, 0.5 Amps 5 VDC ± 0.2 VDC, 0.5 Amps
Additional Information:	A 50-Pin Sub D style connector is mounted on the rear for all inputs/outputs. Adapters are available for converting the 50-pin connector to other style connectors simplifying connection to existing cables. Call for custom adapter requirements

REV.2
1-27-2020



VHF Navigation Receiver Test Panel

ASI-177-1

OEM Equivalent: Bendix
Model Number: RNT-26A
Part Number: 2064139-0501
Manual: I.B. 1126T
Manual Figure: 1

UUT: RNA-26C / RNA-26CF
RNA-34A / RNA-34AF

Size: H: 17.50" W: 19.00" D: 14.00"

PWR: 28 VDC / 115 VAC 400 Hz

Description:

The ASI-177-1 facilitates complete alignment, testing, and troubleshooting, of the Bendix RNA-26C and RNA-34A VHF Navigation Receivers. Testing of the RNA-34A requires ASI-420-1. The ASI-177-1 contains all of the necessary controls, switches, synchros, and wiring to simulate a single system installation. Meters and load resistors provide correct loading and accurate readout of the VOR/LOC and GS instrumentation outputs.

Optional Equipment:

ASI MN	OEM PN	Description
ASI-17-7C	2037551-0501	VHF Receiver Module RF Extender (W110)
ASI-17-7D	2037547-0501	VHF Receiver Module Extender (W111)
ASI-17-7E	2037549-0501	Power Supply Extender (W112)
ASI-17-7F	2037544-0501	LOC Module Extender (W113)
ASI-17-7G	2037546-0501	GS and LOC Monitor Module Ext (W114)
ASI-17-7H	2037545-0501	ILS Check Module Extender (W115)
ASI-17-7I	2037552-0501	RMI Servo Amp Module Extender (W116)
ASI-17-7J	2037551-0502	GS Receiver Module RF Extender (W117)
ASI-17-7K	2037548-0501	GS Receiver Module Extender (W118)
ASI-17-7L	2037159-0501	LOC Dummy Load Assy (A2)
ASI-17-7M	2037159-0502	GS Dummy Load Assy (A3)
ASI-413-2	2070776-3201	ILS Audio Generator (RIT-32A)
ASI-420-1	2041341-3401	RNA-34A Adapter Panel (RNT-34A)
ASI-420-2	3614307-3401	RNA-34AF Adapter Panel (EXT-34AF)
ASI-424-2	2070810-3301	VOR Audio Generator (RVG-33A)
ASI-502	NPN	VOR Omnidirectional Reader (Control Wizard)

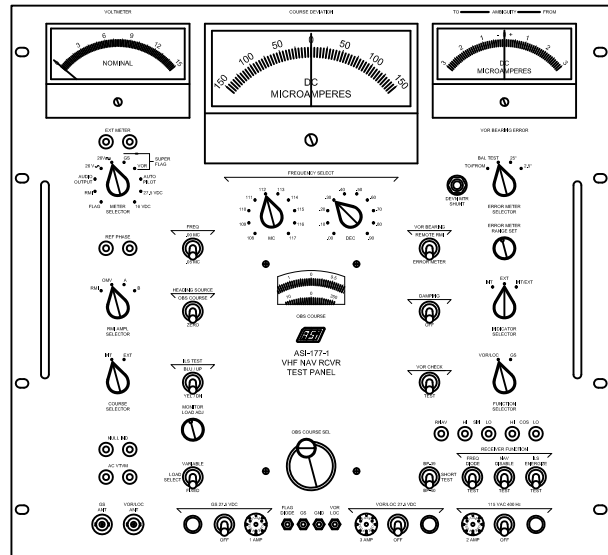

Equipment Supplied:

ASI MN	OEM PN	Description
ASI-17-7A	2037543-0501	RNA Test Cable (W105)
ASI-17-7B	2037550-0501	Resolver/Synchro Calibration Cable (W109)
ASI-17-7N	2037553-0501	Dummy Load Plug Assy (PR1)
ASI-17-7P	NPN	OBS (INA-21B) Cable (W103)
ASI-17-7Q	NPN	Remote RMI (IN-250) Cable (W121)
ASI-17-7R	NPN	RMI (MN-72G) Cable (W104)

VOR/ILS System Test Panel (USCG Version)

ASI-177-2

OEM Equivalent: Bendix
Model Number: RNT-260A
Part Number: 4000951-6002
Manual: TO33D7-36-34-1
Manual Figure: 1-1

UUT: AN/ARN-123

Size: H: 17.50" W: 19.00" D: 14.00"

PWR: 115 VAC 400 Hz

Description:

The ASI-177-2 is a special USCG version of the ASI-177 for testing the AN/ARN-123. The AN/ARN-123 cables are supplied in place of the AN/ARN-127 / AN/ARN-147 cables. See the ASI-177-2-04 (shown below) for the latest version of this test panel.

Equipment Supplied:

ASI MN	OEM PN	Description
ASI-17-72G	3604322-0501	Receiver (R-2023 / R-2139) Cable
ASI-17-72H	3604321-0501	Nav Control Unit Test Cable
ASI-17-72C	3604380-0501	Power Cable
ASI-17-72D1	3604357-0504	GS Coax Cable
ASI-17-72E1	3604357-0505	VOR/LOC Coax Cable
ASI-17-72F1	3604357-0506	MB Coax Cable

Tested System Components:

AN/ARN-123 (R-2023 / R-2139 / C-10048 / C-10049)

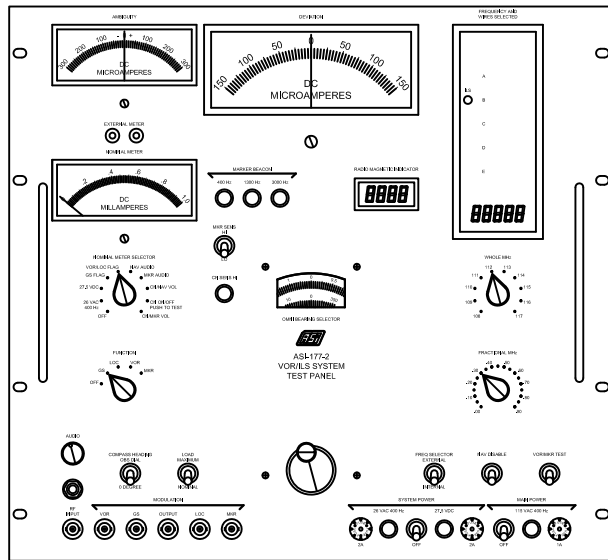

VOR/ILS System Test Panel

ASI-177-2-04

OEM Equivalent: Bendix
Model Number: RNT-260A
Part Number: 4000951-6004
Manual: TO33D7-36-34-1
Manual Figure: 1-1

UUT: AN/ARN-123 / AN/ARN-127
AN/ARN-147 / RN-260B

Size: H: 17.50" W: 19.00" D: 14.00"

PWR: 115 VAC 400 Hz

Description:

The ASI-177-2-04 is a multi-function VOR/ILS Test Panel used for testing and aligning airborne navigation receiver systems including the AN/ARN-127, AN/ARN-127, AN/ARN-147, and RN-260B. See the ASI-177-2 (shown above) for special USCG version of this panel.

Tested System Components:

AN/ARN-123 (R-2023 / R-2139 / C-10048 / C-10049) (Req. Optional Cables)
AN/ARN-127 (R-2032 / C-10124 / C-10125 / C-10218 / C-10490)
AN/ARN-147 (R-2325(V)1 / R-2325(V)2 / VIR-130A)
RN-260B (RN-262B / CN-261A / CN-268A / CN-269A)

Equipment Supplied:

ASI MN	OEM PN	Description
ASI-17-72A	3604050-0501	Receiver (R-2032 / R-2325 / RN-262B) Cable
ASI-17-72B	3604049-0501	Nav Control Unit Test Cable
ASI-17-72C	3604380-0501	Power Cable
ASI-17-72D	3604357-0501	GS Coax Cable
ASI-17-72E	3604357-0502	VOR/LOC Coax Cable
ASI-17-72F	3604357-0503	MB Coax Cable

Optional Equipment:

ASI MN	OEM PN	Description
ASI-17-72G	3604322-0501	Receiver (R-2023 / R-2139) Test Cable
ASI-17-72H	3604321-0501	Control (C-10048 / C-10049) Test Cable
ASI-17-72J		Bench Mock-Up for AN/ARN-147 / VIR-130A
ASI-17-72K	687-4041-001	1553B Adapter (AN/ARN-147 To DCM-1553)
ASI-413-2	2070776-3201	ILS Audio Generator (RIG-32A)
ASI-424-2	2070810-3301	VOR Audio Generator (RVG-33A)

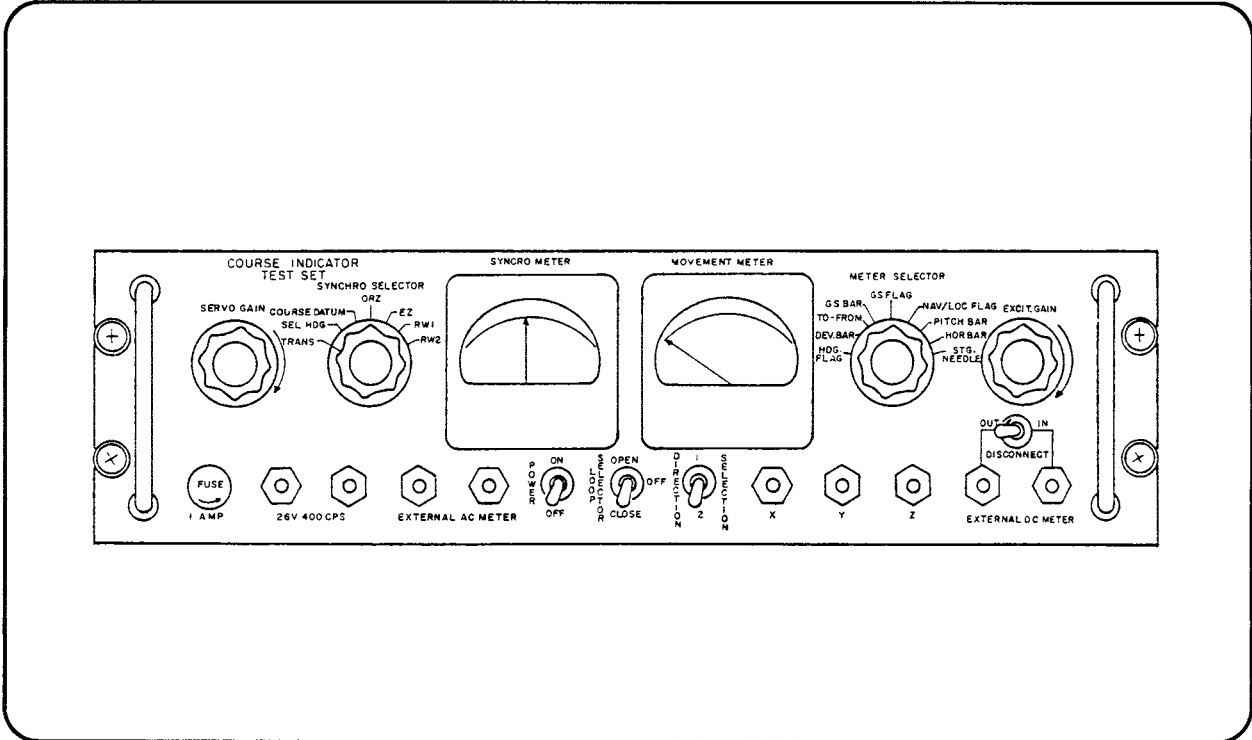

This unit is manufactured to replace the OEM model and/or part number listed below in form, fit, and function.

Equivalent OEM: Collins
 Equivalent MN: 477Q-1 or 477Q-1A
 Equivalent PN: 522-1151-000 or 522-3330-000
 Manual Figure:

Units Tested:
 331A-3F
 331A-3G
 331A-6D

Description of Operation:

The ASI-178 provides all functions required to test Collins 331A-3F/3G/6D course indicators.

The ASI-178 simulates the various ac and dc inputs, checks current to meter movements and synchros, and provides ac input excitation to the servo amplifier for checking servo-motor response.

The ASI-178 requires an ASI-17-8A or ASI-17-8B cable for proper operation.

Specifications:

Height: 5.25" Width: 19.00" Depth: 6.00" Power: 115 VAC 400 Hz

Equipment Supplied:

ASI MN	Equivalent PN	Description
--------	---------------	-------------

Optional Equipment:

ASI MN	Manual Figure	Description
ASI-17-8A	331A-3F/3G Manual Figure 5-25	Cable: ASI-178 to Collins 331A-3F/3G
ASI-17-8B	331A-6D/6E/7/7A Manual Figure 1004	Cable: ASI-178 to Collins 331A-6D
ASI-17-8C	331A-3G Manual Figure 1007	Cable: ASI-178 to 479X-2 (ASI-166)

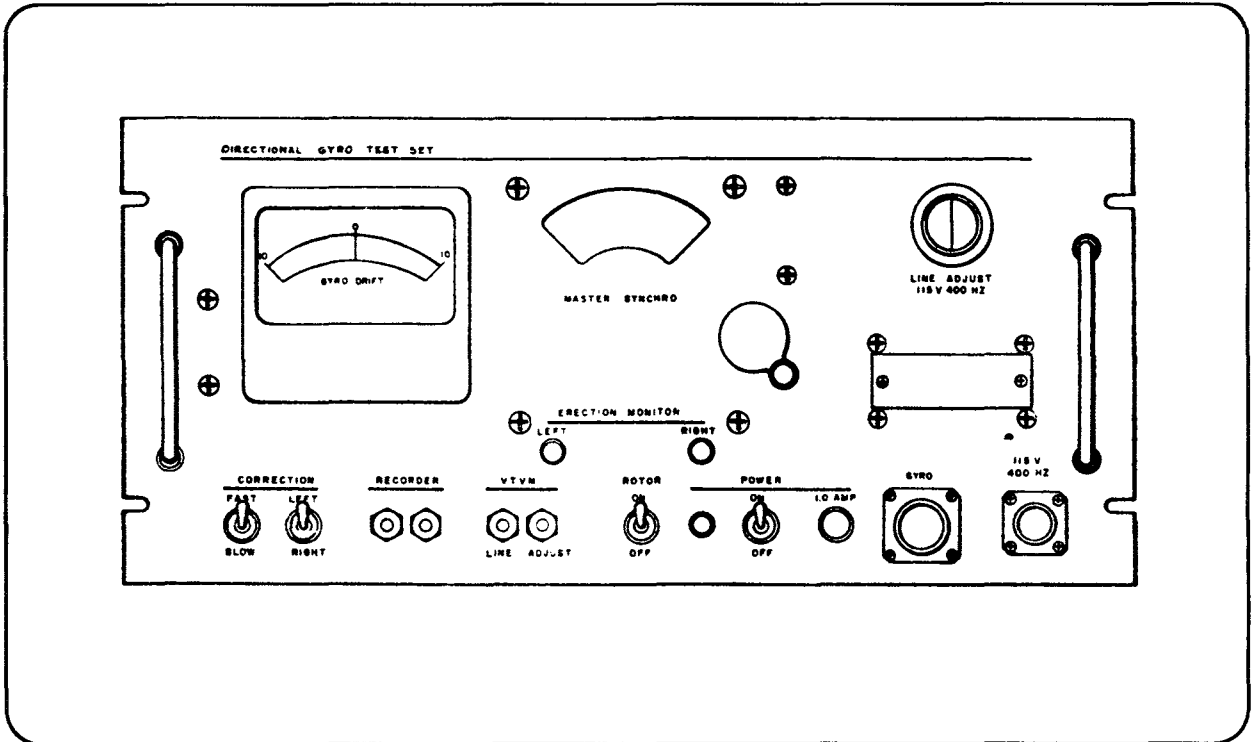

This unit is manufactured to replace the OEM model and/or part number listed below in form, fit, and function.

Equivalent OEM: Collins
 Equivalent MN: 476E-7
 Equivalent PN: 522-2078-000
 Manual Figure:

Units Tested:
 332E-4 Directional Gyro

Description of Operation:

The ASI-179 Directional Gyro Test Set provides the functions and test points needed to test, troubleshoot, and align the Collins 332E-4 Gyro.

The ASI-179 requires the ASI-17-9A cable for proper operation (can be user fabricated or purchased from ASI).

Specifications:

Height: 5.25" Width: 19.00" Depth: 6.00"

Power: 115 VAC 400 Hz

Equipment Supplied:

ASI MN	Equivalent PN	Description
--------	---------------	-------------

Optional Equipment:

ASI MN	Equivalent PN	Description
ASI-17-9A		Cable: ASI-179 to 332E-4

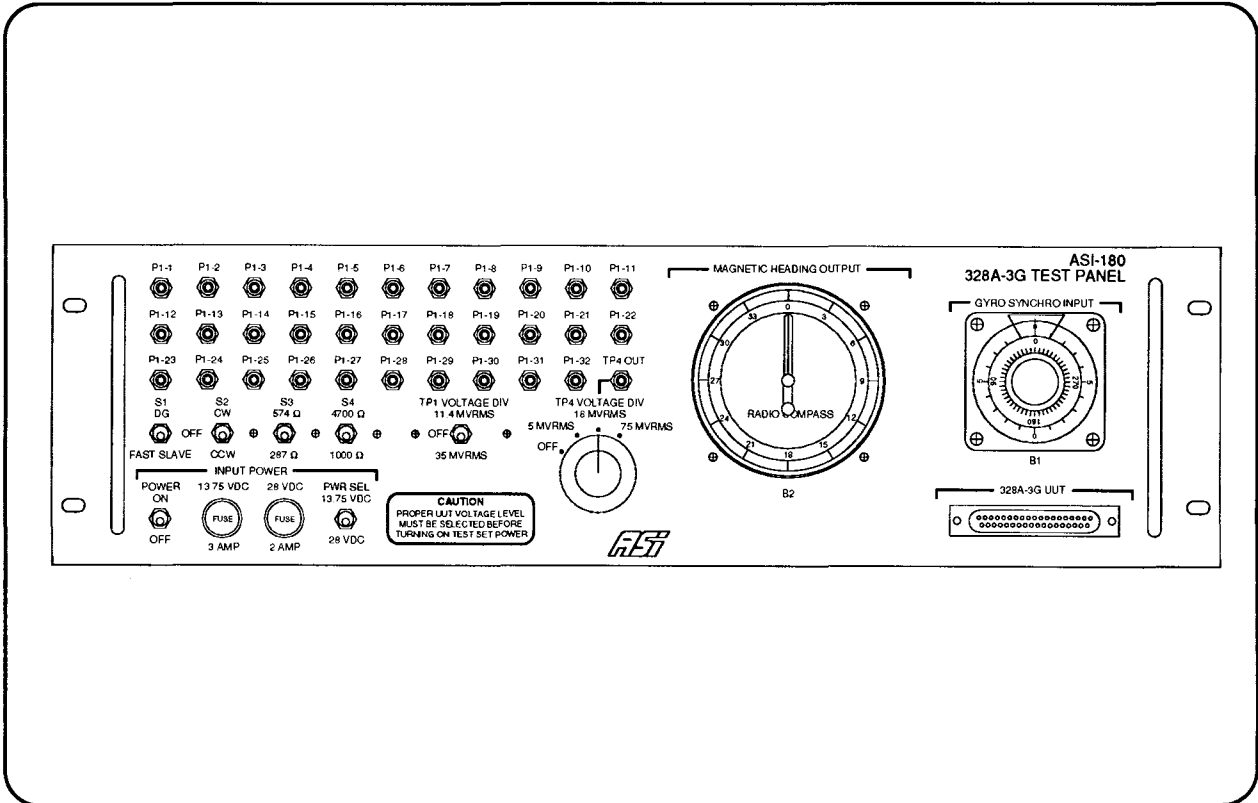

This unit is manufactured to replace the OEM model and/or part number listed below in form, fit, and function.

Equivalent OEM: Collins
 Equivalent MN:
 Equivalent PN:
 Manual Figure: PN-101, Fig. 5-1

Units Tested:
 328A-3G Slaving Accessory

Description of Operation:

The ASI-180 Slaving Accessory Test Set facilitates the testing and repair of the Collins 328A-3G Slaving Accessory (part of the Collins PN-101 Pictorial Navigation System).

The ASI-180 is a direct replacement for the 328A-3G Test Jig shown in the PN-101 manual and allows "by the book" testing of the 328A-3G. The ASI-180 comes complete with a pendant cable for the UUT.

Specifications:

Height: 5.25" Width: 19.00" Depth: 5.00" Power: 28 VDC, 26 VAC 400 Hz

Equipment Supplied:

ASI MN	Equivalent PN	Description
ASI-18-0A	NPN	Cable: ASI-180 to 328A-3G

Optional Equipment:

ASI MN	Equivalent PN	Description
--------	---------------	-------------

DME Test Panel

ASI-182

OEM Equivalent: Rockwell Collins
MN: 975D-2
PN: 622-3582-001
Manual: 523-0767321
Manual Figure: 1

UUT: ARINC 521 / ARINC 568 DME
860E-2/-3/-4/-5 / DME-40

Size: H: 10.50" W: 19.00" D: 9.00"
Pwr: 115 VAC 400Hz

Description:

The ASI-182 DME Test Panel provides operational control and precision testing of ARINC standard Distance Measuring Equipment (DME). When used in conjunction with a simulated ground station (Squawk Naut, ATC-1200Y3, or ATC-1400) the ASI-182 is capable of complete testing of ARINC 521 (860E-2/-4) and ARINC 568 (860E-3/-5) DME equipment in addition to the Collins DME-40.

A user supplied Collins 339D-1 Distance Indicator is required for proper operation of the test panel.

The ASI-182 includes three cables ASI-18-2A, ASI-18-2B, and ASI-18-2C. An optional cable (ASI-18-2D) is required for testing of the DME-40.

See the Optional Equipment section for additional DME test fixtures and maintenance kits available from ASI.

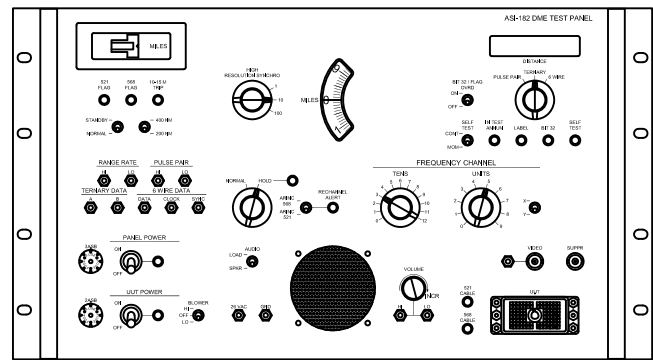

Optional Equipment:

ASI MN	OEM PN	Description
ASI-18-2D	635-5795-001	Cable, ASI-182 to DME-40 (W5)
ASI-18-2E	NPN	Suppressor Load Box
ASI-18-2F	NPN	Fault Mon (A8) Test Fixture
ASI-18-2G	791-8381-001	Tube Extender A
ASI-18-2H	791-8390-001	Tube Extender B
ASI-18-2I	NPN	Cable, Driver input (860E-3 Man Fig 1006)
ASI-18-2J	NPN	Cable, Synthesizer (860E-3 Man Fig 1007)
ASI-283	NPN	DME Troubleshooting Probe
ASI-2235-001	621-2235-001	860E-4/-5 Maintenance Kit
ASI-8405-001	791-8405-001	860E-3 Maintenance Kit

Equipment Supplied:

ASI MN	OEM PN	Description
ASI-18-2A	635-5775-001	Cable, ASI-182 to ARINC 521 DME (W2)
ASI-18-2B	635-5774-001	Cable, ASI-182 to ARINC 568 DME (W3)
ASI-18-2C	635-5791-001	Cable, ASI-182 to Squawk Naut (W4)

Autopilot Test Panel

ASI-183-1

OEM Equivalent: Rockwell Collins
MN: 971F-1
PN: 622-2013-001
Manual: 523-0765576
Manual Figure: 1

UUT: FCS-105 Flight Control System
161E-2A / 562C-5/-5B/-5C/-5F
562C-8A/-8F/-8G / 614E-5A

Size: H: 12.25" W: 19.00" D: 8.00"
Pwr: 28 VDC / 115 VAC 400Hz

Description:

The ASI-183-1 Test Panel tests four major components of the Collins FCS-105 Flight Control System. The Test Panel provides all signal and power switching required during testing of the individual components.

The ASI-183-1 includes all 12 cables required for testing the 161E-2A, 562C-5(), 562C-8(), and 614E-5A.

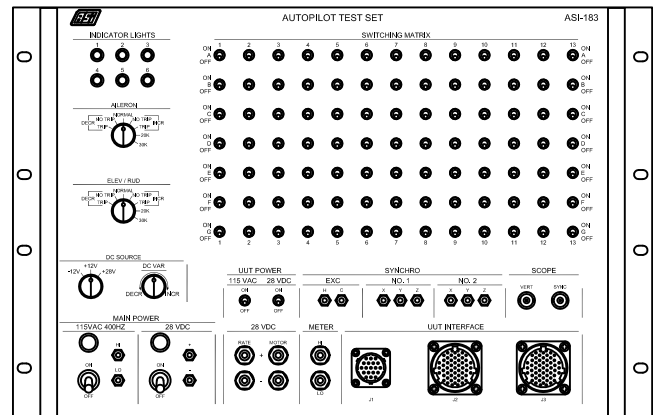

Optional Equipment:

ASI MN	OEM PN	Description
ASI-165	622-5330-001	Synchro Simulator (CSS-10)
ASI-167	522-3498-000	Synchro Simulator (978F-2S)
ASI-247	634-0549-001	562C-8()Yaw Damper Test Fixture

Equipment Supplied:

ASI MN	OEM PN	Description
ASI-18-3A	629-0001-001	Cable, ASI-183 to Gyro Simulator (W1)
ASI-18-3B	629-0002-001	Cable, ASI-183 to 562C-5() (W2)
ASI-18-3C	629-0005-001	Cable, ASI-183 to 161E-2A (W5)
ASI-18-3D	629-0006-001	Cable, ASI-183 to 614E-5A (W6)
ASI-18-3E	629-0007-001	Extender Cable, 562C-5() (W7)
ASI-18-3F	629-0009-001	Extender Cable, 562C-8() (W9)
ASI-18-3G	629-0010-001	Configuration Cable, 562C-5() (W10)
ASI-18-3H	629-9007-001	Configuration Cable, 562C-8F/-8G (W11)
ASI-18-3I	629-9008-001	Test Adapter, 562C-8F (W12)
ASI-18-3J	634-9299-001	Extender Cable, 562C-8F/-8G (W13)
ASI-18-3K	634-9668-001	Extender Cable, 562C-8() (W14)
ASI-18-3L	634-2714-001	Cable Adapter, 562C-8G (W15)

Autopilot Test Panel

ASI-183-2

OEM Equivalent: Rockwell Collins
MN: 971F-1
PN: 622-2013-002
Manual: 523-0765576
Manual Figure: 1

UUT: FCS-105 Flight Control System
161E-2A / 562C-5/-5B/-5C/-5F
562C-8A/-8F/-8G / 614E-5A

Size: H: 12.25" W: 19.00" D: 8.00"
Pwr: 28 VDC / 115 VAC 400Hz

Description:

The ASI-183-2 Test Panel is identical to the ASI-183-1 except that it is not supplied with test cables.

The ASI-183-2 requires optional cables for testing the 161E-2A, 562C-5(), 562C-8(), and 614E-5A. See optional equipment section for more information on test cables.

Equipment Supplied:

ASI MN	OEM PN	Description
--------	--------	-------------

Optional Equipment:

ASI MN	OEM PN	Description
ASI-18-3A	629-0001-001	Cable, ASI-183 to Gyro Simulator (W1)
ASI-18-3B	629-0002-001	Cable, ASI-183 to 562C-5() (W2)
ASI-18-3C	629-0005-001	Cable, ASI-183 to 161E-2A (W5)
ASI-18-3D	629-0006-001	Cable, ASI-183 to 614E-5A (W6)
ASI-18-3E	629-0007-001	Extender Cable, 562C-5() (W7)
ASI-18-3F	629-0009-001	Extender Cable, 562C-8() (W9)
ASI-18-3G	629-0010-001	Configuration Cable, 562C-5() (W10)
ASI-18-3H	629-9007-001	Configuration Cable, 562C-8F/-8G (W11)
ASI-18-3I	629-9008-001	Test Adapter, 562C-8F (W12)
ASI-18-3J	634-9299-001	Extender Cable, 562C-8F/-8G (W13)
ASI-18-3K	634-9668-001	Extender Cable, 562C-8() (W14)
ASI-18-3L	634-2714-001	Cable Adapter, 562C-8G (W15)
ASI-165	622-5330-001	Synchro Simulator (CSS-10)
ASI-167	522-3498-000	Synchro Simulator (978F-2S)
ASI-247	634-0549-001	562C-8() Yaw Damper Test Fixture

ADF Fault Isolation Panel

ASI-184

OEM Equivalent: Rockwell Collins
 MN: 477V-3
 PN: 792-6209-001
 Manual: 523-0762771
 Manual Figure: 1

UUT: DF-206 ADF System
 51Y-7 / 51Y-7A
 Size: H: 3.50" W: 19.00" D: 6.00"
 Pwr: From UUT

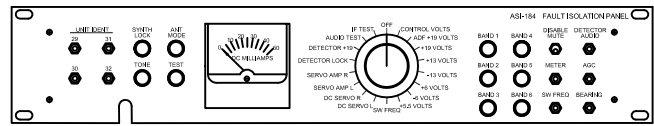

Description:

The ASI-184 Fault Isolation Panel isolates faults when testing the Collins DF-206 ADF System. Complete system checkout can be accomplished using this unit in conjunction with the 477U-2, 477V-2, and a rf signal generator.

The ASI-184 provides signals to operationally test the various subassemblies of the DF-206. Resultant outputs can be monitored either aurally or on a bearing indicator. Monitoring functions allow checking of the system operating, switching, and control voltages. The front panel meter provides a visual indication of each monitored voltage.

The ASI-185 includes a pendant cable for interconnection of the unit under test.

Equipment Supplied:

ASI MN	OEM PN	Description
--------	--------	-------------

Optional Equipment:

ASI MN	OEM PN	Description
ASI-19-2D	554-6109-004	Low Capacitance Sense Antenna Adapter
ASI-192	522-2710-000	ADF Antenna Simulator (477U-2)
ASI-193	522-2711-002	ADF Test Panel (477V-2)

ADF Test Panel

ASI-185

OEM Equivalent: Rockwell Collins
 MN: 970G-1
 PN: 622-2854-001
 Manual: 523-0766184 / 523-0773906
 Manual Figure: 6-1 - 6-3 / 5-27 - 5-29

UUT: ADF-60A/B / ADF-462
 ANT-60A/B / ANT-462A/B
 Size: H: 8.75" W: 19.00" D: 12.00"
 Pwr: 5 VDC / 28 VDC / 26 VAC 400Hz

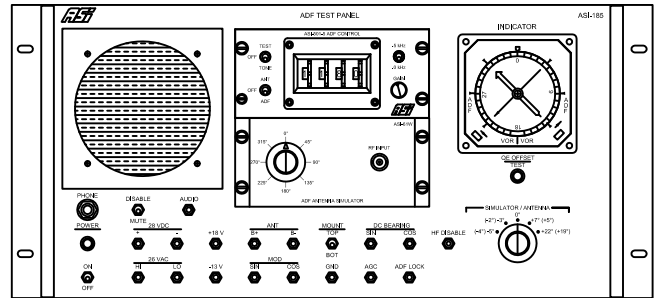

Description:

The ASI-185 ADF Test Panel provides a means to test, align, and repair the Collins ADF-60 and ADF-462. Testing of the ADF-462 also requires the optional ASI-135 test panel. Interconnection of the unit under test is provided by a pendant cable.

The Test Panel requires a user supplied Control (614L-11/12/13 / ASI-501-5), RMI (332C-10 / RMI-36) and an ADF Antenna Simulator (970W-1 / ASI-61 / ASI-61W) for proper operation. These are shown installed but are not provided with the test panel.

Equipment Supplied:

ASI MN	OEM PN	Description
ASI-18-5A	629-9558-001	Cable, ASI-185 to 332C-10 / RMI-30
ASI-18-5B	629-9557-001	Cable, ASI-185 to RMI-36

Optional Equipment:

ASI MN	OEM PN	Description
ASI-18-5C	687-7902-001	Cable, ASI-185 to ANT-60B / ANT-462B
ASI-18-5D	NPN	Cable, ASI-185 to ASI-61 (Not req for ASI-61W)
ASI-61W	622-3099-001	ADF Antenna Simulator (970W-1)
ASI-135	NPN	ADF-462 Test Panel
ASI-278	622-3874-001	ADF Antenna Tester (969W-1)
ASI-501-5	NPN	ADF Control Head Simulator

ADF Antenna Simulator

ASI-186

OEM Equivalent: Rockwell Collins
 MN: 970W-1
 PN: 622-3099-001
 Manual: 523-0766184 / 523-0773906
 Manual Figure: 6-22,6-25,6-26 / 5-21,5-24,5-25

UUT: ADF-60A / ADF-60B
 ADF-462 / DFR-206A
 Size: H: 2.62" W: 5.75" D: 5.00"
 Pwr: From Test Panel

The ASI-186 has been replaced by the ASI-61W. See the ASI-61W catalog page for more info.

Description:

The ASI-186 ADF Antenna Simulator provides the simulated directional ADF signal required for testing and alignment of the Collins ADF-60A/B, ADF-462, and DFR-206A ADF Receivers. See the ASI-61 for a functionally equivalent ADF Antenna Simulator packaged in a standard 19" rack mount chassis. The ASI-186 is shown installed in the ASI-185 (970G-1) ADF Test Panel above.

Optional Equipment:

ASI MN	OEM PN	Description
ASI-61W	NPN	ADF Antenna Simulator (970W-1 Equivalent)
ASI-185	622-2854-001	ADF Test Panel (970G-1)
ASI-375-1	622-7345-001	ADF Test Panel (970G-2)
ASI-375-2	622-7345-002	ADF Test Panel (970G-2)
ASI-0412-001	NPN	ADF Antenna Simulator Breakout/Test Box

RMI Test Panel

ASI-187

OEM Equivalent: Rockwell Collins
 MN: 970E-1
 PN: 622-2914-001
 Manual: 523-0767201
 Manual Figure: 1-1

UUT: 332C-4 / 332C-8 / 332C-10
 RMI-30 / RMI-36 / BDI-36
 Size: H: 12.25" W: 19.00" D: 9.00"
 Pwr: 28 VDC / 115 VAC 400Hz

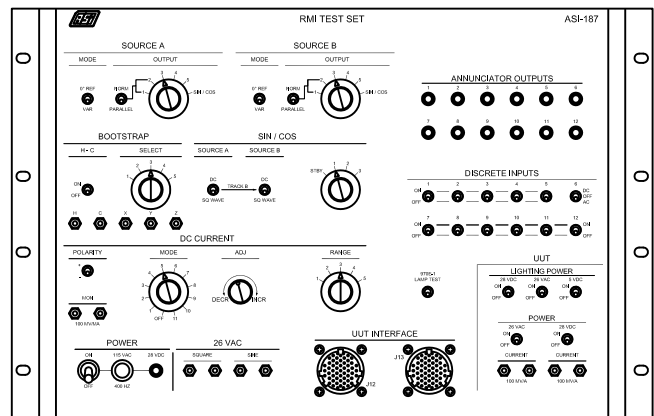

Description:

The ASI-187 RMI Test Panel is used in conjunction with a Synchro Source (ASI-165 or ASI-167) and a digital voltmeter to facilitate testing and troubleshooting of Collins RMI's (Radio Magnetic Indicators).

The ASI-187 requires optional ASI-18-7X cables for interconnection of the uut.

Optional Equipment:

ASI MN	OEM PN	Description
ASI-18-7A	NPN	Cable, ASI-187 to ASI-165 or ASI-167
ASI-18-7B	NPN	Cable, ASI-187 to 332C-4
ASI-18-7C	NPN	Cable, ASI-187 to 332C-8
ASI-18-7D	NPN	Cable, ASI-187 to 332C-10 / RMI-30
ASI-18-7E	NPN	Cable, ASI-187 to 332C-10B
ASI-18-7F	NPN	Cable, ASI-187 to RMI-36 / BDI-36 / AAR-3337
ASI-18-7H	NPN	Cable, ASI-187 to 36105 / AAR-2105
ASI-18-7I	NPN	Cable, ASI-187 to 36135 / AAR-2107
ASI-165	622-5330-001	Synchro Source (CSS-10)
ASI-167	522-3498-000	Synchro Source (978F-2S)

Equipment Supplied:

ASI MN	OEM PN	Description
--------	--------	-------------

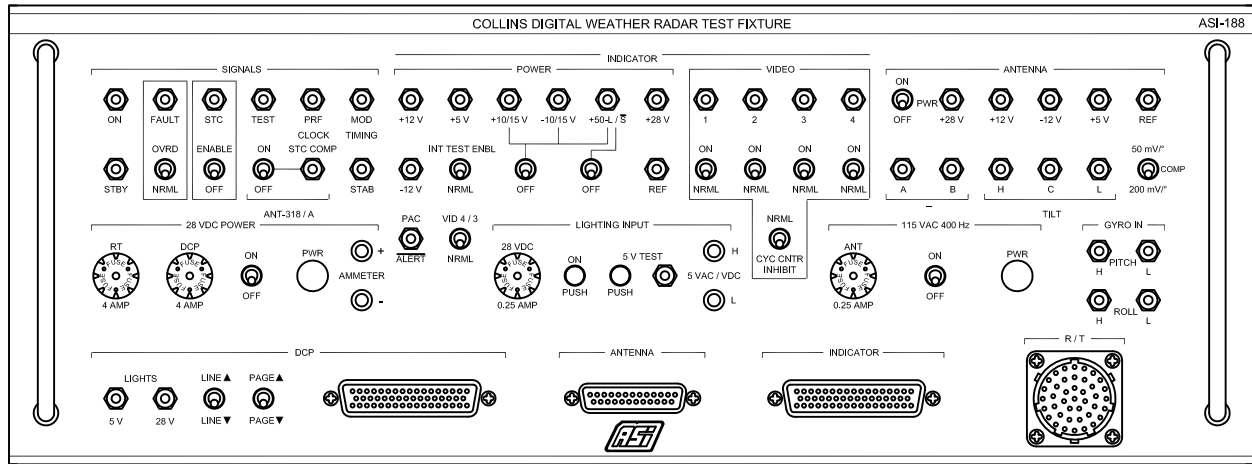

OEM Equivalent:

OEM: Rockwell Collins
 Model Number:
 Part Number:
 Manual:
 Manual Figure:

This unit is manufactured to replace the OEM MN, PN, and/or manual figure listed in Form, Fit, and Function.

Units Tested:

Radar Systems: WXR-150/-200/-200A/-220/-250A/-270/-270A/-300/-350
 WXT-150/-200/-200A/-250A/-250B
 IND-150/-200/-200A/-201/-220/-250A/-250C/-270/-270A/-300
 ANT-152/-210/-212/-212D/-310/-310A/-312/-312A/-318/-318A
 WXA-85
 WXP-85A/-85B/-85C/-85D
 DCP-270/-300/-320/-325

Description:

The ASI-188-1 WXR Digital Radar Test Panel provides capability to test, align, and repair the Collins WXR series of digital weather radar systems. The ASI-188-1 is the rack-mount version of the test panel and includes modifications 1, 2, 3, 4, 5.

The ASI-188-1 includes cables to interconnect the test panel with the R/T, Indicator, and Antenna. Optional test equipment and cables are available to test the Antenna (ANT), Indicator (IND), Display Control Panel (DCP) and Weather Radar Panel (WXP).

The WXR Digital Weather Radar Test Panel (ASI-188-1) is shown in numerous Collins manuals including the following:

UUT	MANUAL	MANUAL FIGURE
WXR-150	523-0767292	5-3, 5-6A, 5-6B, 5-6C
WXR-200A	523-0768532	5-3, 5-7, 5-8, 5-9
WXR-220	523-0771169	2-25, 2-29, 2-30, 2-31
WXR-250A	523-0770194	5-3, 5-7, 5-8, 5-9
WXR-270	523-0771162	2-20, 2-24, 2-25, 2-26
WXR-270A	523-0777202	2-22, 2-26, 2-27, 2-28
WXR-300	523-0768937	2-22, 2-26, 2-27, 2-28
WXR-350	523-0774518	1, 5, 6, 7 (Supplement)
WXT-200A	523-0768771	1, 5, 6, 7 (Supplement)
WXT-250A	523-0768783	1, 5, 6, 7 (Supplement)
WXT-250B	523-0773856	1, 5, 6, 7 (Supplement)

Equipment Supplied:

ASI MN	OEM PN	Description
ASI-18-8A	NPN	Cable: ASI-188-1 to WXT R/T
ASI-18-8B	NPN	Cable: ASI-188-1 to IND Indicator
ASI-18-8C	NPN	Cable: ASI-188-1 to ANT Antenna

Optional Equipment:

ASI MN	Description
ASI-188-2	ANT-310/312/318 Cal-Test Fixture (WXR-270A Fig. 5-8, 5-9 / WXR-300 Fig. 5-8, 5-9 / WXR-350 Fig. 5-7, 5-8)
ASI-188-3	Flight Line Test Fixture (WXR-150 Fig. 5-7 - 5-9 / WXR-270A/300 5-4 - 5-7 / WXR-350 Fig. 5-7, 5-8)
ASI-188-4	IND-270A Test Fixture (IND-270A 5-13 - 5-17 / WXR-270A Fig. 2-31 - 2-35)
ASI-188-5	WXP-85A/B, DPU-85/86, EFD-85/86, DCP-85, DSP-85 Breakout Box (WXP-85 Fig. 905)
ASI-188-6	WXP-85A/B, MPU-85/86, MFD-85, DCP-85, DSP-85 Breakout Box (WXP-85 Fig. 906)
ASI-188-7	WXP-85() Breakout Box (IND-270A Fig. 907)
ASI-188-8	DPU-85/86, EFD-85/86, DCP-85, DSP-85 Breakout Box (WXP-85 Fig. 908)
ASI-18-8D	Cable: DCP-270/300/320/325 J2
ASI-18-8E1	Cable: WXP-85C/D Special Adapter (WXP-85 Fig. 904)
ASI-18-8E2	Cable: WXP-85A Special Adapter (WXP-85 Fig. 902)
ASI-18-8E3	Cable: WP-85B Special Adapter (WXP-85 Fig. 903)
ASI-18-8F	Cable: DCP-270/300/320/325 J1
ASI-18-8G	Cable: WXA-85 Test Cable No. 1 (WXR-270A Fig. 2-29)
ASI-18-8H	Cable: WXA-85 Test Cable No. 2 (WXR-270A Fig. 2-30)
ASI-297	IND-300 Generator Test Panel (CTS-300 / 622-4946-001)

Specifications:

Height: 7.00" Width: 19.00" Depth: 6.50"
 Power Requirements: 115 VAC 400 Hz

Universal Precision Track Selector

ASI-190

OEM Equivalent:
 OEM: Rockwell Collins
 Model Number: 479V-3
 Part Number: 522-1339-001
 Manual:
 Manual Figure:

Description:
 The ASI-190 Universal Precision Track Selector facilitates testing and calibration of manual VOR converters and the VOR section of VHF navigation receivers.

The ASI-190 includes a To-From meter and test jacks for Deviation, To-From, and Flag signals. The Omni bearing selector resolver is capable of both EZ (400 Hz) and ORZ (30 Hz) operation and allows continuous 360° tracking in 0.1° increments. An external load is supplied with the ASI-190 to simulate a To-From dual load.

The ASI-190 will electrically replace the Collins 479V-3 Track Selector. For a direct form, fit, and function replacement of the 479V-3 please see the ASI-161 Track Selector

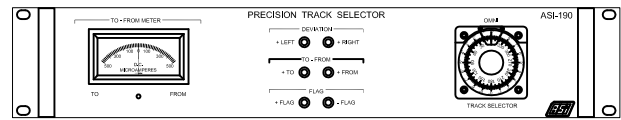

Units Tested:
 Various

Specifications:
 Height: 3.50" Width: 19.00" Depth: 13.00"
 Power Requirements: From unit under test

Equipment Supplied:

ASI MN	OEM PN	Description
ASI-19-0A	NPN	Dual Load Simulator Plug

Optional Equipment:

ASI MN	OEM PN	Description
ASI-16-B4	NPN	Adapter Cable: ASI-190() to 479V-3 Cable
ASI-215	NPN	Synchro/Resolver/CT Test Panel

Universal Precision Track Selector

ASI-190B

OEM Equivalent:
 OEM: Rockwell Collins
 Model Number: 479V-3
 Part Number: 522-1339-001
 Manual:
 Manual Figure:

Description:
 The ASI-190B Universal Precision Track Selector facilitates testing and calibration of manual VOR converters and the VOR section of VHF navigation receivers.

The ASI-190B includes internal meters and test jacks for Deviation, To-From, and Flag signals. The Omni bearing selector resolver is capable of both EZ (400 Hz) and ORZ (30 Hz) operation and allows continuous 360° tracking in 0.1° increments. The ASI-190B can simulate up to 5 Flag and Deviation loads and dual To-From loads.

The ASI-190B will electrically replace the Collins 479V-3 Track Selector. For a direct form, fit, and function replacement of the 479V-3 please see the ASI-161 Track Selector.

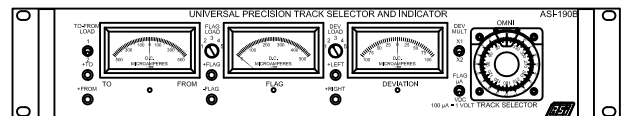

Units Tested:
 Various

Specifications:
 Height: 3.50" Width: 19.00" Depth: 13.00"
 Power Requirements: From unit under test

Equipment Supplied:

ASI MN	OEM PN	Description
ASI-19-0A	NPN	Dual Load Simulator Plug

Optional Equipment:

ASI MN	OEM PN	Description
ASI-16-B4	NPN	Adapter Cable: ASI-190() to 479V-3 Cable
ASI-215	NPN	Synchro/Resolver/CT Test Panel

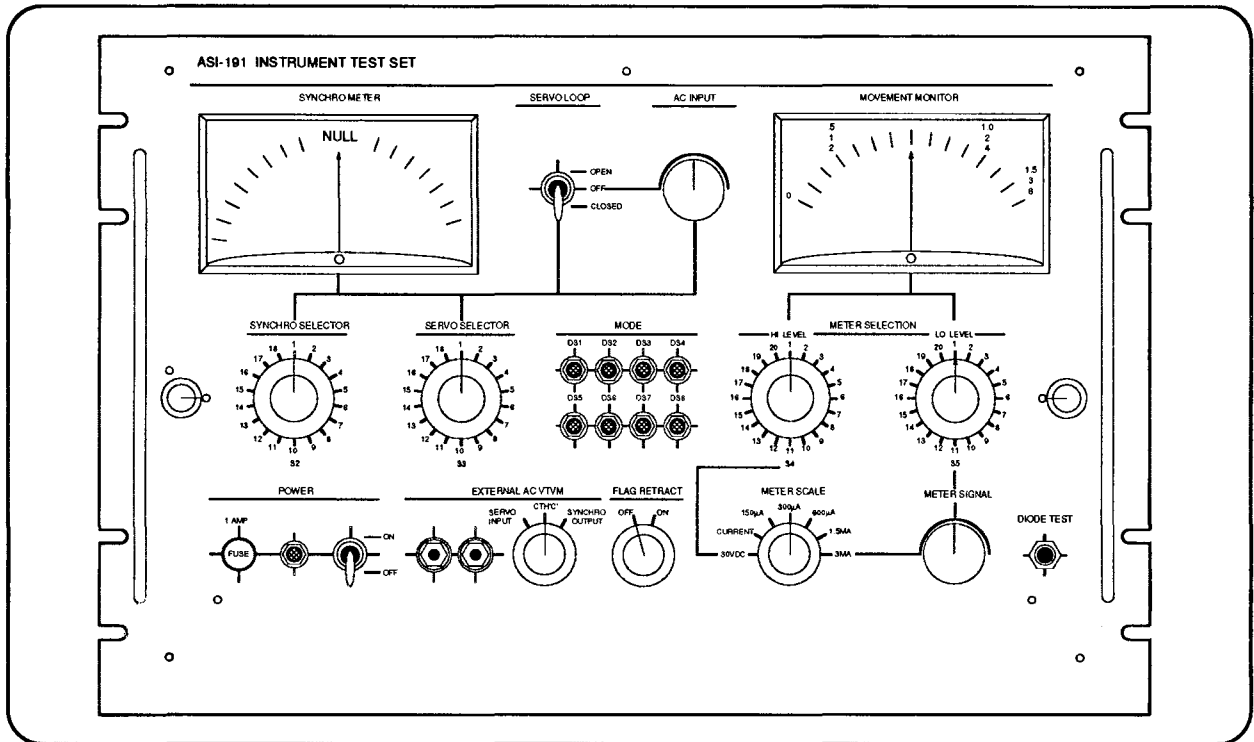

This unit is manufactured to replace the OEM model and/or part number listed below in form, fit, and function.

Equivalent OEM: Collins
 Equivalent MN: 978F-1D
 Equivalent PN: 522-3424-000
 Manual Figure:

Units Tested:
 329B-6/7/8 series Flight Directors
 331A-6/7 series Course Indicators

Description of Operation:

The ASI-191 Instrument Test Set is configured to provide a convenient, self-contained mean of testing Collins 329B-6/7/8 series Flight Directors and 331A-6/7 series Course Indicators. When the ASI-191 is used in conjunction with the ASI-167 (978F-2S) Synchro Simulator and ASI-166 (479X-2) Resolver Zeroing Panel, circuits are provided to check synchro zeroing and phasing, open and closed loop servo response and accuracy, meter movement sensitivity/polarity, integral lighting, and mode switch operation. The ASI-191 is supplied with the General Overlay.

Specifications:

Height: 12.25" Width: 19.00" Depth: 7.25" Power: 115 VAC 400 Hz

Equipment Supplied:

ASI MN	Equivalent PN	Description
--------	---------------	-------------

Optional Equipment:

ASI MN	Equivalent PN	Description
ASI-40X-3	522-4708-001	Cable: ASI-191 to ASI-167 (978F-2S)
ASI-40X-4	522-4709-001	Cable: ASI-191 to 329B-7/329B-8
ASI-40X-5	522-4710-001	Cable: ASI-191 to ASI-166 (479X-2)
ASI-40X-6	522-4711-001	Cable: ASI-191 to 331A-6/331A-7 (P1)
ASI-40X-7	522-4712-001	Cable: ASI-191 to 331A-6/331A-7 (P2)
ASI-40X-8	522-4713-001	Cable: ASI-191 to 331A-6P/331A-6R
ASI-40X-9	522-4714-001	Cable: ASI-191 to 331A-6A1/331A-6K1
ASI-40X-10	522-2715-001	Cable: ASI-191 to 331D-3, AQU-2/2A
ASI-191-001 through -023	757-0544-0XX	Overlay Panels (last two digits of cpn correspond to last two digits of ASI MN)
ASI-166	522-0167-001	Resolver Zeroing Panel (479X-2)
ASI-167	522-3498-000	Synchro Simulator (978F-2S)

ADF Antenna Simulator

ASI-192

OEM Equivalent:

OEM: Rockwell Collins
 Model Number: 477U-2
 Part Number: 522-2710-000
 Manual: 523-0750000
 Manual Figure:

This unit is manufactured to replace the OEM MN, PN, and/or manual figure listed in Form, Fit, and Function.

Description:

The ASI-192 ADF Antenna Simulator is used in conjunction with the ASI-192 (477V-2) for testing the Collins DF203/206 ADF Systems. The ASI-192 can also be used in conjunction with a Collins 477V-1 to test the DF-202G ADF system. The ASI-192 provides simulated loop and sense signals to the ADF receiver. Relative direction of the simulated signal is controlled by the front panel knob geared to a pointer on a 360° scale. Corresponding bearing from the receiver is displayed on the radio compass bearing indicator.

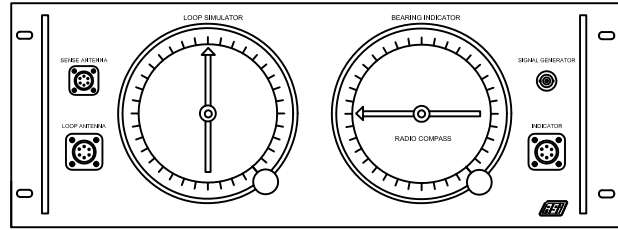

Equipment Supplied:

ASI MN	OEM PN	Description
ASI-19-2A	549-6540-003	Cable: Sense Antenna
ASI-19-2B	544-5037-002	Cable: Simulator RF Input
ASI-19-2C	549-6545-004	Cable: Loop Antenna

Optional Equipment:

ASI MN	OEM PN	Description
ASI-19-2D	554-6109-004	Low Capacitance Sense Antenna Adapter
ASI-184	792-6209-001	Fault Isolation Panel (477V-3)
ASI-193	522-2711-002	ADF Test Panel (477V-2)
ASI-233	NPN	RF Balance Adjustment Test Fixture
ASI-234	NPN	50 Ohm Probe
ASI-235	NPN	Special Solder Tip

Units Tested:

DF-202G: 51Y-3, 179L-1, 614L-2, 440L-3
 DF-203: 51Y-4/4A, 614L-8
 DF-206: 51Y-7/7A, 614L-11/12/13

Specifications:

Height: 7.00" Width: 19.00" Depth: 6.00" Power: From ASI-193 / 477V-3

ADF Test Panel

ASI-193

OEM Equivalent:

OEM: Rockwell Collins
 Model Number: 477V-2
 Part Number: 522-2711-002
 Manual: 523-0751000
 Manual Figure:

Description:

The ASI-193 ADF Test Panel tests the Collins DF-203 and DF-206 ADF Systems. The ASI-193 provides interface between the system components, bench test equipment, and primary power for the test setup. The ASI-193 provides all of the interconnections between the system receiver, control unit, audio loads, audio output meter (part of the ASI-193), and external bearing indicator (ASI-192 / 477U-2). A 100 kHz spectrum oscillator is also provided in the test panel for dial accuracy measurements and calibration of the receiver frequency. Power voltages supplied by the ASI-193 for systems tests are 26 VAC 400 Hz and 28 VDC. The power supply provides for controlled wave form generation with minimum conduction of externally generated noise. The ASI-193 requires a user supplied 614L-8/11/12/13 control for proper operation.

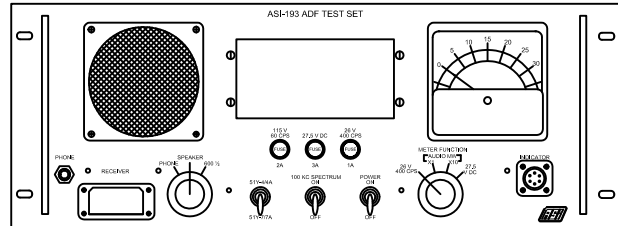

Specifications:

Height: 7.00" Width: 19.00" Depth: 9.0" Power: 115 VAC 60 Hz

Equipment Supplied:

ASI MN	OEM PN	Description
ASI-19-3A	549-6544-004	Cable: ASI-193 to Receiver
ASI-19-3B	549-6543-004	Cable: ASI-193 to Indicator
ASI-19-3C	426-5047-000	Cable: AC Power

Optional Equipment:

ASI MN	OEM PN	Description
ASI-184	792-6209-001	Fault Isolation Panel (477V-3)
ASI-192	522-2710-000	ADF Antenna Simulator (477U-2)

Units Tested:

DF-203: 51Y-4/4A, 614L-8
 DF-206: 51Y-7/7A, 614L-11/12/13

860F-1/4 Test Panel

ASI-194

OEM Equivalent:

OEM: Rockwell Collins
 Model Number:
 Part Number:
 Manual: 523-0768499 / 523-0773759
 Manual Figure: 902-906 / 903-907

This unit is manufactured to replace the OEM MN, PN, and/or manual figure listed in Form, Fit, and Function.

Description:

The ASI-194 Test Panel allows testing and alignment of the Collins 860F-1 / 860F-4 Radio Altimeters. The Test Panel includes the interconnect cables for the 860F-1/4 Main Connector (P1B), Test Connector (J9) and the 339H-() Indicator required during testing. The optional ASI-240-2 RF Cable Set is also required for testing. The ASI-194 has been remodeled into a 19" rack mount panel. For an equivalent bench top chassis design please see the ASI-237.

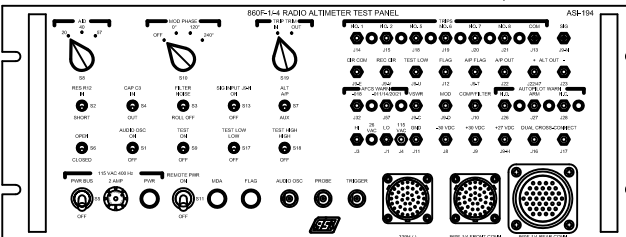

Specifications:

Height: 7.00" Width: 19.00" Depth: 6.00" Power: 28 VDC

Optional Equipment:

ASI MN	OEM PN	Description
ASI-19-4D	NPN	15 Pin Extender Cable
ASI-164	NPN	Radio Altimeter Indicator Test Panel
ASI-203	522-4610-004	Ramp Test Set for 860F-1/4 (980N-1)
ASI-237	NPN	860F-1/4 Bench Top Style Test Fixture
ASI-238	NPN	Transmitter Alignment Tool
ASI-239	635-6254-001	Special Coaxial Wrench
ASI-240	NPN	RF Cable Set (Two 15 Ft RG-214/U Cables)
ASI-241	622-6100-001	Microprocessor Test Adapter (MST-901)
ASI-719	NPN	Pulse Generator Test Box

Units Tested:

860F-1 / 860F-4

Equipment Supplied:

ASI MN	OEM PN	Description
ASI-19-4A	NPN	Cable: ASI-194 To 860F-1/4 P1B
ASI-19-4B	NPN	Cable: ASI-194 To 860F-1/4 J9
ASI-19-4C	NPN	Cable: ASI-194 To 339H-()

PS-823 Power Supply Test Panel

ASI-195

OEM Equivalent:

OEM: Goodrich / L3 / Jet
 Model Number:
 Part Number:
 Manual: TP-202 / 24-20-03
 Manual Figure: 106

This unit is manufactured to replace the OEM MN, PN, and/or manual figure listed in Form, Fit, and Function.

Description:

The ASI-195 facilitates testing and charging of the Goodrich / L3 / Jet PS-823() series of Emergency Power Supplies.

The ASI-195 provides the capability for "by the book" testing and charging procedures for the PS-823().

The ASI-195 comes complete with test interconnect cable for the PS-823().

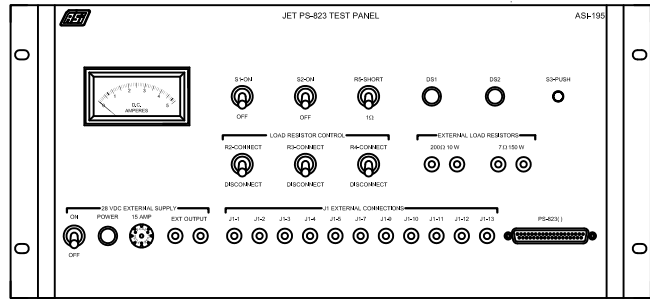

Units Tested:

PS-823()

Specifications:

Height: 8.75" Width: 19.00" Depth: 6.0" Power: 28 VDC

Equipment Supplied:

ASI MN	OEM PN	Description
ASI-19-5A	NPN	Cable, ASI-195 to PS-823()

Optional Equipment:

ASI MN	OEM PN	Description
--------	--------	-------------

PS-835 Power Supply Test Panel

ASI-196

OEM Equivalent:

OEM: Goodrich / L3 / Jet
 Model Number:
 Part Number:
 Manual: TP-329 / 24-30-02
 Manual Figure: 102,106

This unit is manufactured to replace the OEM MN, PN, and/or manual figure listed in Form, Fit, and Function.

Description:

The ASI-196 facilitates testing and charging of the Goodrich / L3 / Jet PS-835() series of Emergency Power Supplies.

The ASI-196 provides the capability for "by the book" testing and charging procedures for the PS-835(). The ASI-196 also has the ability to individually test the A2-PCB (542-1521, 542-1364, and 542-1495) outside of the UUT.

The ASI-196 comes complete with test interconnect cables for the PS-835() and the A2-PCB.

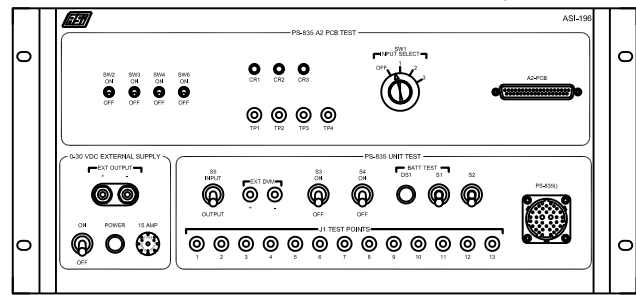

Units Tested:

PS-835()
 PS-835() A2 PCB (542-1521 / 542-1364 / 542-1495)

Specifications:

Height: 8.75" Width: 19.00" Depth: 6.0" Power: 0-40 VDC

Equipment Supplied:

ASI MN	OEM PN	Description
ASI-19-6A	NPN	Cable, ASI-196 to PS-835()
ASI-19-6B	NPN	Cable, ASI-196 to A2 PCB

Optional Equipment:

ASI MN	OEM PN	Description
--------	--------	-------------

PS-850 / PS-855 Power Supply Test Panel

ASI-196-1

OEM Equivalent:

OEM: Goodrich / L3 / Jet
 Model Number: JT-138A
 Part Number: 570-7996-01
 Manual: TP-483 / 24-30-08
 Manual Figure: 102,104,105

This unit is manufactured to replace the OEM MN, PN, and/or manual figure listed in Form, Fit, and Function.

Description:

The ASI-196-1 facilitates testing and charging of the Goodrich / L3 / Jet PS-850() and PS-855() Emergency Power Supplies.

The ASI-196-1 provides the capability for "by the book" testing and charging procedures for the PS-850() and PS-855().

The ASI-196-1 comes complete with the test interconnect cable for the PS-850() and the PS-855().

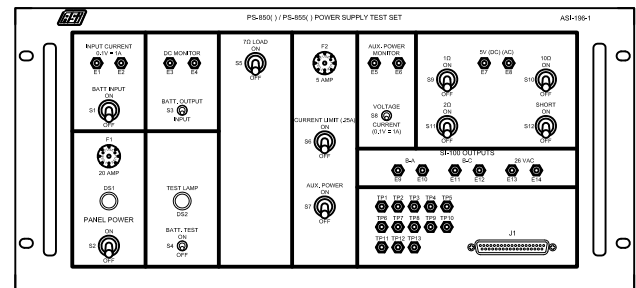

Units Tested:

PS-850()
 PS-855()

Specifications:

Height: 8.75" Width: 19.00" Depth: 6.0" Power: 0-40 VDC

Equipment Supplied:

ASI MN	OEM PN	Description
ASI-19-61A	JF-380A	Cable, ASI-196-1 to PS-850() / PS-855().

Optional Equipment:

ASI MN	OEM PN	Description
--------	--------	-------------

Radar Test Pattern Generator

ASI-197

OEM Equivalent:

OEM: Bendix
 Model Number: PPT-1CG
 Part Number: 2041323-0101
 Manual: I.B. 1102FT / 34-41-56
 Manual Figure: 1

This unit is manufactured to replace the OEM MN, PN, and/or manual figure listed in Form, Fit, and Function.

Description:

The ASI-197 Radar Test Pattern Generator provides test patterns and color select signals required during testing of the PPI-1T, PPI-1U, and PPI-4B Radar Indicators. Testing of the PPI-1U requires the optional ASI-198 Radar Test Pattern Generator Adapter.

The ASI-197 generates crosshatch, color bars and solid color pattern test signals. The crosshatch and solid patterns can be displayed in any of four colors (Blue, Green, Yellow, Red). The color bar pattern displays all four colors simultaneously.

The ASI-197 also includes Mod 3 which allows testing of TCAS modified PPI-() Radar Indicators.

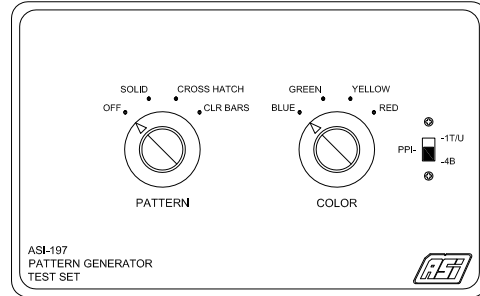

Units Tested:

- PPI-1T
- PPI-1U
- PPI-1U(C)
- PPI-4B

Specifications:

Height: 4.50" Width: 7.25" Depth: 2.00"
 Power Requirements: From UUT

Equipment Supplied:

ASI MN	OEM PN	Description
ASI-19-7A	NPN	Inline Test Connector, PPI-1()
ASI-19-7B	NPN	Inline Test Connector, PPI-4B

Optional Equipment:

ASI MN	OEM PN	Description
ASI-174	2038141-0501	Radar Indicator Test Panel (PPT-1B)
ASI-198	2039597-0501	Radar Test Pattern Generator Adapter
ASI-742	2041589-0401	Radar System Test Panel (RCT-4A)
ASI-760	2041591-0401	Radar Indicator Test Panel (PPT-4A)

Radar Test Pattern Generator Adapter

ASI-198

OEM Equivalent:

OEM: Bendix
 Model Number:
 Part Number: 2039597-0501
 Manual: I.B. 1101U / 34-41-23
 Manual Figure: 903.1 - 903.2 (TR34-27)

This unit is manufactured to replace the OEM MN, PN, and/or manual figure listed in Form, Fit, and Function.

Description:

The ASI-198 Radar Test Pattern Generator Adapter interconnects the ASI-197 (PPT-1CG) Radar Test Pattern Generator to the Bendix PPI-1U Radar Indicator during testing.

The ASI-197 interfaces the ASI-197 (PPT-1CG) to the checklist connector (J5103) of the PPI-1U Weather Radar Indicator. The Adapter also interfaces the checklist connector to standard ARINC control format for indicators equipped with a built-in control.

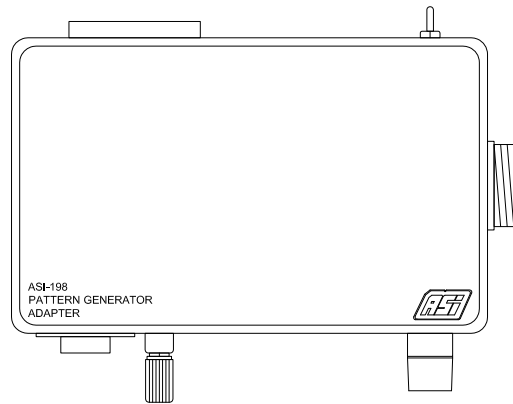

Units Tested:

- PPI-1U

Specifications:

Height: 4.50" Width: 7.25" Depth: 2.00"
 Power Requirements: 28 VDC

Equipment Supplied:

ASI MN	OEM PN	Description
ASI-197	2041323-0101	Radar Test pattern Generator (PPT-1CG)

Optional Equipment:

ASI MN	OEM PN	Description
ASI-174	2038141-0501	Radar Indicator Test Panel (PPT-1B)
ASI-197	2041323-0101	Radar Test pattern Generator (PPT-1CG)

Radar Altimeter Test Panel

ASI-199

OEM Equivalent:

OEM: Bendix
 Model Number: ALT-51A
 Part Number: 2037120-0501
 Manual: I.B. 1151AT-1 / 34-10-15
 Manual Figure: 1

This unit is manufactured to replace the OEM MN, PN, and/or manual figure listed in Form, Fit, and Function.

Description:

The ASI-199 Radio Altimeter Test Panel facilitates testing, adjustment, and troubleshooting of the Bendix ALA-51A Radio Altimeter and INA-51A/B/V Radio Altimeter Indicator.

The ASI-199 includes two main sections, a test panel (ASI-199-1) and a precision delay line (ASI-199-3). The ASI-199 includes all switching, metering, calibrated delays, attenuators, indicators and interconnecting cables required to operate and function test the ALA-51A Radio Altimeter System.

The Test Panel has provisions for connecting an INA-51 indicator under test in addition to connecting a test indicator to assist in the alignment and testing of the ALA-51A Radio Altimeter. Built in test features permit the servicing and calibration of indicators on the bench without the additional requirement of a known good ALA-51A Radio Altimeter.

The ASI-199 includes seven interconnecting test cables and two extender boards required testing for the ALA-51A and INA-51().

Additional items required to test the ALA-51A are listed in the Optional Equipment section below.

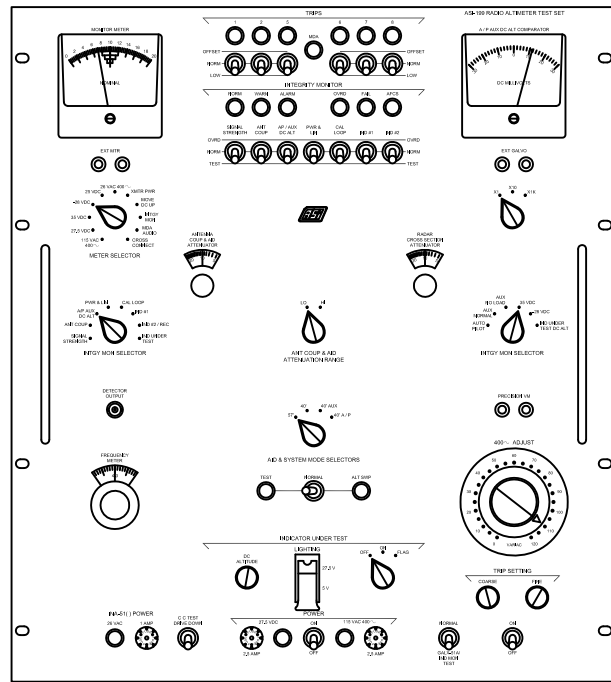

Units Tested:

ALA-51A INA-51B
 INA-51A INA-51V

Equipment Supplied:

ASI MN	OEM PN	Description
ASI-199-1	2037120-0501	Test Panel
ASI-199-3	2068256-0701	Delay Line, 650 nS
ASI-19-9A	2037536-0501	Cable, ASI-199-1 to ALA-51A J1 (W101)
ASI-19-9B	2037533-0501	Cable, ASI-199-1 Power Input (W102)
ASI-19-9C	2037517-0501	Cable, ASI-199-1 to ALA-51 P1 (W103)
ASI-19-9D	2037535-0501	Cable, ASI-199-1 to INA-51 P1 (W104)
ASI-19-9E	2037554-0501	Cable, ASI-199-1 to INA-51 P1 (W105)
ASI-19-9G	2038137-0007	Cable, ASI-199-1 to ASI-199-3 (W112)
ASI-19-9H	2038137-0008	Cable, ASI-199-1 to ASI-199-3 (W114)
ASI-19-9I	2037075-0501	Extender Card, Narrow
ASI-19-9J	2037075-0502	Extender Card, Wide

Specifications:

Height: 21.00" Width: 19.00" Depth: 13.00"
 Power Requirements: 115 VAC 400 Hz / 27.5 VDC

Optional Equipment:

ASI MN	OEM PN	Description
ASI-19-9K	TT-1241	Stripline Test Adapter
ASI-19-9L	TT-3-2037042	Center Conductor Alignment Tool
ASI-19-9M	TT-6-2037042	Center Conductor Alignment Ring
ASI-19-9N		Transmitter Extender Cable
ASI-19-9P		Transmitter Test Connector
ASI-175	2037028-5103	Portable Altimeter Test Set (AMT-51A)
ASI-199-4		Transmitter Test Modulator
ASI-199-5		Transmitter Test Fixture

Radio Altimeter Precision Delay Line

ASI-199-3

OEM Equivalent:

OEM: Bendix
 Model Number:
 Part Number: 2068256-0701
 Manual: I.B. 1151AT-1 / 34-10-15
 Manual Figure: 1

This unit is manufactured to replace the OEM MN, PN, and/or manual figure listed in Form, Fit, and Function.

Description:

The ASI-199-3 is a 650 ns Precision Delay Line required for testing the ALA-51A Radio Altimeter. While the ASI-199-3 is supplied with the ASI-199 Test Set it may also be purchased separately.

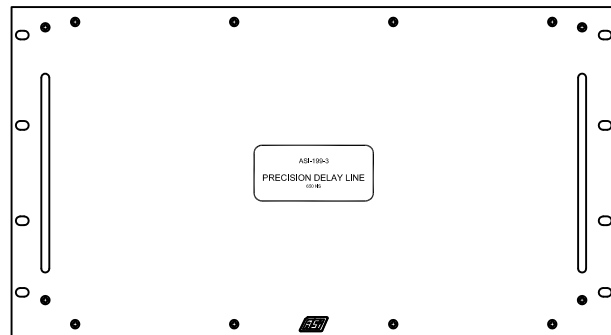

Equipment Supplied:

ASI MN	OEM PN	Description
ASI-175	2037028-5103	Portable Altimeter Test Set (AMT-51A)

Units Tested:

ALA-51A INA-51B
 INA-51A INA-51V

Specifications:

Height: 10.50" Width: 19.00" Depth: 19.00"
 Power Requirements: Not Required

Pro Line Test System Mainframe

ASI-2000

Description:

The ASI-2000 Main Frame is the heart of the ASI Pro Line Test System. It works in conjunction with the CTC-429 Computer Board, ASI-401-X Pro Line / PC Interface Panel, Computer and various ASI-200-X Plug In Adapters to test Collins Pro Line / Pro Line II / Pro Line 4 Avionics. The ASI-2000 provides the power, test points and computer interface required during testing of the various avionics LRU's. The ASI-2000 is also capable of manually testing ARINC standard avionics using existing Linaire test cables (user supplied).

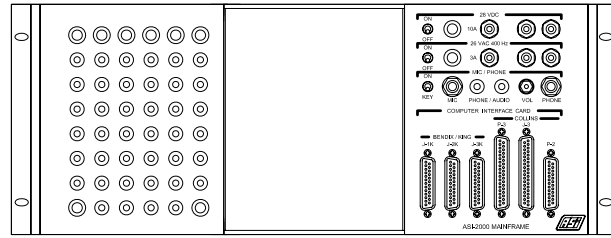

Software required for testing Pro Line Avionics must be purchased directly from the Rockwell Collins by the end user. See individual ASI-200-X catalog pages or LRU CMM for software part numbers.

Units Tested:

Pro Line / Pro Line II / Pro Line 4 / ARINC Standard

Optional Plug In Adapters:

ASI MN	Unit Tested
ASI-200-1	CTL-X2/X2A/X2C/X3/X3C
ASI-200-2A	VIR-30/31/32/33 (Requires ASI-161/190/190B)
ASI-200-2B	VIR-30/31/32/33 (External HDG/OBS Source Not Required)
ASI-200-2C	VIR-30/31/32/33 (Requires ASI-160)
ASI-200-2D	VIR-30/31/32/33 (Requires ASI-160B/160C)
ASI-200-3	VHF-20/21/22
ASI-200-4	CAD-31/62
ASI-200-5	DME-40/42/IND-42
ASI-200-6	CTL-230
ASI-200-8	ARINC COM (Requires Linaire LT-5/LA-5 Cables)
ASI-200-9	ARINC NAV (Requires Linaire LV-5 Cables)
ASI-200-10	ADF-60/462
ASI-200-11	VHF-422
ASI-200-12	VIR-432/433
ASI-200-13	DME-442
ASI-200-14	TDR-90/CAD-870G
ASI-200-15	DDA-42
ASI-200-17A	RTU-870/870A/870T
ASI-200-18	CAD-870/RAC-870
ASI-200-19	BIA-32
ASI-200-20	ALT-50A/55B/860F-2
ASI-200-21	CTL-X0/X1
ASI-200-22	BRG-40
ASI-200-23	ARINC GS (Requires Linaire LG-4 Cables)
ASI-200-24	ARINC DME (Requires Linaire LD-4 Cables)
ASI-200-25	ARINC Transponder (Requires Linaire LX-3B Cables)
ASI-200-26	ARINC MB (Requires Linaire LM-3 Cables)
ASI-200-27	CTL-92T
ASI-200-28	ASI-2000 System Self Test Adapter

Specifications:

Height: 7.00" Width: 19.00" Depth: 13.00"
 Power Requirements: 26 VAC 400 Hz / 28 VDC

Optional Equipment:

ASI MN	OEM PN	Description
ASI-61	622-3099-001	ADF Antenna Simulator (19" Rack Mount)
ASI-61W	622-3099-001	ADF Antenna Simulator (970W-1)
ASI-160B		Heading and Track Selector
ASI-160C		Heading and Track Selector with Meters
ASI-161	522-1339-000	Track Selector (479V-3)
ASI-190		Track Selector
ASI-190B		Track Selector with Meters
ASI-200-5A1	647-6787-001	DME Simulator
ASI-278	622-3874-001	ADF Antenna Tester (969W-1)
ASI-500-1		Control Head Simulator
ASI-500-2		Control Head Simulator (8.33 kHz)
ASI-401-1		Pro Line / PC Interface (Standard Cables)
ASI-401-2		Pro Line / PC Interface (Custom Cables)
ASI-401-3		Pro Line / PC Interface (Long Cables)
ASI-402	638-0199-001	CTC-429 Serial Loopback Pod
ASI-2001		Computer with Internal CTC-429/ASI-401
ASI-CTC-429	822-0854-001	Pro Line Computer Board (CTC-429)

Pro Line Computer System

ASI-2001

Description:

The ASI-2001 Pro Line Computer System combines the functions of the PC Computer, CTC-429 Computer Card, and the ASI-401 Pro Line/PC Interface Panel into a single rack mountable computer.

The ASI-CTC-429 and ASI-401-ISA are internally mounted in the ASI-2001 computer chassis and all connections are accessible from the front for easy interface to external test equipment (ASI-2000 or other Pro Line test fixtures manufactured to Collins specifications). The ASI-2001 includes a standard keyboard and mouse. The monitor (ASI-20-01F or equivalent) must be purchased separately.

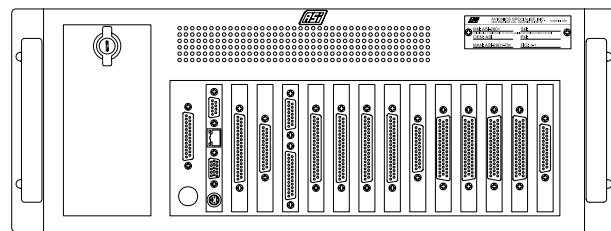

The ASI-2001 is also available in three alternate configurations:
 ASI-2001-1: Computer with ASI-401-ISA installed.
 ASI-2001-2: Computer with ASI-CTC-429 installed.
 ASI-2001-3: Computer only (Without ASI-401-ISA or ASI-CTC-429)

Units Tested:

Rockwell Collins Pro Line II / Pro Line 4 Avionics

The ASI-2001 ships with MS-DOS pre-loaded, however all Pro Line Test Software must be purchased directly from Rockwell Collins.

Specifications:

Height: 7.00" Width: 19.00" Depth: 18.00"
 Power Requirements: 115/230 VAC 47-63 Hz

Equipment Supplied with ASI-2001:

ASI MN	OEM PN	Description
ASI-10-401A		Cable, ASI-401-ISA J2 to Pro Line J3
ASI-10-401B		Cable, ASI-401-ISA J3 to Pro Line P3
ASI-10-401C		Cable, ASI-401-ISA J7 to Pro Line P2
ASI-10-401D		Cable, ASI-401-ISA J8 to ARINC 429
ASI-20-01A		Cable, CTC-429 J10 to ASI-401-ISA J1
ASI-20-01B		Cable, CTC-429 J12 to ASI-401-ISA J33
ASI-20-01C		Cable, CTC-429 J14 to ASI-401-ISA J32
ASI-CTC-429	822-0854-001	Pro Line Computer Board (Internal)
ASI-401-ISA		Pro Line / PC Interface Board (Internal)

Optional Equipment:

ASI MN	OEM PN	Description
ASI-2000		Pro Line Test System Mainframe
ASI-20-01F		Rack Mount Computer Monitor (LCD)
ASI-402	638-0199-001	CTC-429 Serial Loopback Pod

Gold Crown Apple IIe Computer System

ASI-2002

<p>Description: The ASI-2002 Gold Crown Computer System combines the functions of the Apple IIe Computer, Monitor, ASync and Sync Computer Cards into a single computer system package.</p> <p>The ASI-2002 provides all the computer functions required to test the Gold Crown series of Avionics (KDM-706A / KFS Controls).</p> <p>The Apple IIe Computer, Monitor and Disk Drives included with the ASI-2002 are reconditioned by ASI and include a full 1 Year ASI Warranty.</p> <p>The ASI-2002 is also available in three alternate configurations: ASI-2002-1: Apple IIe Computer with ASync Card Kit installed. ASI-2002-2: Apple IIe Computer with Sync Card Kit installed. ASI-2002-3: Apple IIe Computer only (Without ASync or Sync Card).</p> <p>The ASI-2002 ships with the Bendix-King Test Disks for the KDM-706A and KFS Controls. The ASI-2002-1 includes the KDM-706A Test Disk.</p>	<p>Units Tested: KDM-706A KFS-564A / KFS-576A / KFS-579A / KFS-586A / KFS-598A</p>																																	
	<p>Specifications: Height: 18.00" Width: 15.00" Depth: 18.00" Power Requirements: 115 VAC 60 Hz</p>																																	
	<p>Test Disks Supplied:</p> <table border="1"> <thead> <tr> <th>OEM PN</th> <th>ALT PN</th> <th>Description</th> </tr> </thead> <tbody> <tr> <td>222-00002-0000</td> <td>222-0002-00</td> <td>KFS-564/A Test Disk</td> </tr> <tr> <td>222-00003-0000</td> <td>222-0003-00</td> <td>KFS-586/A Test Disk</td> </tr> <tr> <td>222-00004-0000</td> <td>222-0004-00</td> <td>KFS-579/A Test Disk</td> </tr> <tr> <td>222-00005-0000</td> <td>222-0005-00</td> <td>KFS-576/A Test Disk</td> </tr> <tr> <td>222-00006-0001</td> <td>222-0006-01</td> <td>KFS-598/A Test Disk</td> </tr> <tr> <td>222-00120-0000</td> <td>222-0120-00</td> <td>KDM-706A Test Disk</td> </tr> </tbody> </table> <p>The ASI-2002 includes all Test Disks listed above. The ASI-2002-1 includes KDM-706A Test Disk only. The ASI-2002-2 and ASI-2002-3 do not include Test Disks.</p>	OEM PN	ALT PN	Description	222-00002-0000	222-0002-00	KFS-564/A Test Disk	222-00003-0000	222-0003-00	KFS-586/A Test Disk	222-00004-0000	222-0004-00	KFS-579/A Test Disk	222-00005-0000	222-0005-00	KFS-576/A Test Disk	222-00006-0001	222-0006-01	KFS-598/A Test Disk	222-00120-0000	222-0120-00	KDM-706A Test Disk												
OEM PN	ALT PN	Description																																
222-00002-0000	222-0002-00	KFS-564/A Test Disk																																
222-00003-0000	222-0003-00	KFS-586/A Test Disk																																
222-00004-0000	222-0004-00	KFS-579/A Test Disk																																
222-00005-0000	222-0005-00	KFS-576/A Test Disk																																
222-00006-0001	222-0006-01	KFS-598/A Test Disk																																
222-00120-0000	222-0120-00	KDM-706A Test Disk																																
<p>Equipment Supplied with ASI-2002:</p> <table border="1"> <thead> <tr> <th>ASI MN</th> <th>OEM PN</th> <th>Description</th> </tr> </thead> <tbody> <tr> <td>ASI-050-2605-00</td> <td>050-02605-0000</td> <td>ASync Computer Card Kit (Internal)</td> </tr> <tr> <td>ASI-050-2606-00</td> <td>050-02606-0000</td> <td>Sync Computer Card Kit (Internal)</td> </tr> <tr> <td></td> <td>A2S2064*</td> <td>Apple IIe Computer / Keyboard</td> </tr> <tr> <td></td> <td>A2M2010*</td> <td>Apple II Computer Monitor</td> </tr> <tr> <td></td> <td>A9M0180*</td> <td>Duodisk / Dual Disk Drives</td> </tr> </tbody> </table> <p>* Equivalent part numbers may be substituted</p>	ASI MN	OEM PN	Description	ASI-050-2605-00	050-02605-0000	ASync Computer Card Kit (Internal)	ASI-050-2606-00	050-02606-0000	Sync Computer Card Kit (Internal)		A2S2064*	Apple IIe Computer / Keyboard		A2M2010*	Apple II Computer Monitor		A9M0180*	Duodisk / Dual Disk Drives	<p>Optional Equipment:</p> <table border="1"> <thead> <tr> <th>ASI MN</th> <th>OEM PN</th> <th>Description</th> </tr> </thead> <tbody> <tr> <td>ASI-2000</td> <td></td> <td>Test System Mainframe</td> </tr> <tr> <td>ASI-200-7</td> <td></td> <td>Plug-In Adapter for KFS Controls</td> </tr> <tr> <td>ASI-200-16</td> <td></td> <td>Plug-In Adapter for KDM-706A</td> </tr> <tr> <td>ASI-71</td> <td>064-01034-0001</td> <td>KFS Test Power Supply (KA-579A)</td> </tr> </tbody> </table>	ASI MN	OEM PN	Description	ASI-2000		Test System Mainframe	ASI-200-7		Plug-In Adapter for KFS Controls	ASI-200-16		Plug-In Adapter for KDM-706A	ASI-71	064-01034-0001	KFS Test Power Supply (KA-579A)
ASI MN	OEM PN	Description																																
ASI-050-2605-00	050-02605-0000	ASync Computer Card Kit (Internal)																																
ASI-050-2606-00	050-02606-0000	Sync Computer Card Kit (Internal)																																
	A2S2064*	Apple IIe Computer / Keyboard																																
	A2M2010*	Apple II Computer Monitor																																
	A9M0180*	Duodisk / Dual Disk Drives																																
ASI MN	OEM PN	Description																																
ASI-2000		Test System Mainframe																																
ASI-200-7		Plug-In Adapter for KFS Controls																																
ASI-200-16		Plug-In Adapter for KDM-706A																																
ASI-71	064-01034-0001	KFS Test Power Supply (KA-579A)																																

ASync Card Kit

ASI-050-2605-00

<p>OEM Equivalent: Honeywell / Bendix-King PN: 050-02605-0000 Manual: 006-5210-00 Manual Figure: 3-2</p>	<p>Units Tested: KDM-706A KFS-564A / KFS-576A / KFS-579A / KFS-586A / KFS-598A</p>																																	
<p>Description: The ASI-050-2605-00 ASync Card Kit includes the ASync Card and 3 interconnect ribbon cables.</p> <p>The ASync Card is used in conjunction with an Apple IIe Computer and the ASI-2000/ASI-200-7/-16 or KCT-110/-160 to test the Honeywell / Bendix-King KFS series of Control Heads or the KDM-706A DME.</p> <p>The ASync Card includes ARINC-429(2RX/1TX), RS-422(1RX/1TX), and various parallel and analog input/output ports required during testing of the KDM-706A and the various KFS Controls.</p>	<p>Equipment Supplied:</p> <table border="1"> <thead> <tr> <th>ASI MN</th> <th>OEM PN</th> <th>Description</th> </tr> </thead> <tbody> <tr> <td>ASI-200-7157-00</td> <td>200-07157-0000</td> <td>ASync Computer Card</td> </tr> <tr> <td>ASI-155-5664-16</td> <td>155-05664-0016</td> <td>ASync Cable P1</td> </tr> <tr> <td>ASI-155-5664-06</td> <td>155-05664-0006</td> <td>ASync Cable P2</td> </tr> <tr> <td>ASI-155-5664-12</td> <td>155-05664-0012</td> <td>ASync Cable P3 / Cable 3</td> </tr> </tbody> </table> <p>Optional Equipment:</p> <table border="1"> <thead> <tr> <th>ASI MN</th> <th>OEM PN</th> <th>Description</th> </tr> </thead> <tbody> <tr> <td>ASI-2000</td> <td></td> <td>Pro Line Test System Mainframe</td> </tr> <tr> <td>ASI-2002</td> <td></td> <td>Apple Computer Test System</td> </tr> <tr> <td>ASI-200-7</td> <td></td> <td>Plug-In Adapter for KFS Controls</td> </tr> <tr> <td>ASI-200-16</td> <td></td> <td>Plug-In Adapter for KDM-706A</td> </tr> <tr> <td>ASI-71</td> <td>064-01034-0001</td> <td>KFS Test Power Supply (KA-579A)</td> </tr> </tbody> </table>	ASI MN	OEM PN	Description	ASI-200-7157-00	200-07157-0000	ASync Computer Card	ASI-155-5664-16	155-05664-0016	ASync Cable P1	ASI-155-5664-06	155-05664-0006	ASync Cable P2	ASI-155-5664-12	155-05664-0012	ASync Cable P3 / Cable 3	ASI MN	OEM PN	Description	ASI-2000		Pro Line Test System Mainframe	ASI-2002		Apple Computer Test System	ASI-200-7		Plug-In Adapter for KFS Controls	ASI-200-16		Plug-In Adapter for KDM-706A	ASI-71	064-01034-0001	KFS Test Power Supply (KA-579A)
ASI MN	OEM PN	Description																																
ASI-200-7157-00	200-07157-0000	ASync Computer Card																																
ASI-155-5664-16	155-05664-0016	ASync Cable P1																																
ASI-155-5664-06	155-05664-0006	ASync Cable P2																																
ASI-155-5664-12	155-05664-0012	ASync Cable P3 / Cable 3																																
ASI MN	OEM PN	Description																																
ASI-2000		Pro Line Test System Mainframe																																
ASI-2002		Apple Computer Test System																																
ASI-200-7		Plug-In Adapter for KFS Controls																																
ASI-200-16		Plug-In Adapter for KDM-706A																																
ASI-71	064-01034-0001	KFS Test Power Supply (KA-579A)																																

Sync Card Kit

ASI-050-2606-00

<p>OEM Equivalent: Honeywell / Bendix-King PN: 050-02606-0000 Manual: 006-5211-00 Manual Figure: 3-2</p>	<p>Units Tested: KFS-564A / KFS-576A / KFS-579A / KFS-586A / KFS-598A</p>																											
<p>Description: The ASI-050-2606-00 Sync Card Kit includes the Sync Card and 2 interconnect ribbon cables.</p> <p>The Sync Card is used in conjunction with an Apple IIe Computer and the ASI-2000/ASI-200-7 or KCT-110 to test the Honeywell / Bendix-King KFS series of Control Heads.</p> <p>The Sync Card receives and interprets King Serial Data along with other test data and interfaces this information to the computer as required during function testing of the KFS controls.</p>	<p>Equipment Supplied:</p> <table border="1"> <thead> <tr> <th>ASI MN</th> <th>OEM PN</th> <th>Description</th> </tr> </thead> <tbody> <tr> <td>ASI-200-7164-00</td> <td>200-07164-0000</td> <td>Sync Computer Card</td> </tr> <tr> <td>ASI-155-5664-07</td> <td>155-05664-0007</td> <td>Sync Cable P2 / Cable 1</td> </tr> <tr> <td>ASI-155-5664-17</td> <td>155-05664-0017</td> <td>Sync Cable P3 / Cable 2</td> </tr> </tbody> </table> <p>Optional Equipment:</p> <table border="1"> <thead> <tr> <th>ASI MN</th> <th>OEM PN</th> <th>Description</th> </tr> </thead> <tbody> <tr> <td>ASI-2000</td> <td></td> <td>Pro Line Test System Mainframe</td> </tr> <tr> <td>ASI-2002</td> <td></td> <td>Apple Computer Test System</td> </tr> <tr> <td>ASI-200-7</td> <td></td> <td>Plug-In Adapter for KFS Controls</td> </tr> <tr> <td>ASI-71</td> <td>064-01034-0001</td> <td>KFS Test Power Supply (KA-579A)</td> </tr> </tbody> </table>	ASI MN	OEM PN	Description	ASI-200-7164-00	200-07164-0000	Sync Computer Card	ASI-155-5664-07	155-05664-0007	Sync Cable P2 / Cable 1	ASI-155-5664-17	155-05664-0017	Sync Cable P3 / Cable 2	ASI MN	OEM PN	Description	ASI-2000		Pro Line Test System Mainframe	ASI-2002		Apple Computer Test System	ASI-200-7		Plug-In Adapter for KFS Controls	ASI-71	064-01034-0001	KFS Test Power Supply (KA-579A)
ASI MN	OEM PN	Description																										
ASI-200-7164-00	200-07164-0000	Sync Computer Card																										
ASI-155-5664-07	155-05664-0007	Sync Cable P2 / Cable 1																										
ASI-155-5664-17	155-05664-0017	Sync Cable P3 / Cable 2																										
ASI MN	OEM PN	Description																										
ASI-2000		Pro Line Test System Mainframe																										
ASI-2002		Apple Computer Test System																										
ASI-200-7		Plug-In Adapter for KFS Controls																										
ASI-71	064-01034-0001	KFS Test Power Supply (KA-579A)																										

CTL-X2/X2A Control Plug-In**ASI-200-1**Description of Operation:

The ASI-200-1, when used with the ASI-2000 and a computer, allows testing and repair of the Collins CTL-X2/X2A line of control heads.

The Plug-in is equipped with a hardwired CTL-32/32A cable and 3 adapter cables to test the CTL-22/62/92. An adapter cable to test the CTL-23 is optional.

The ASI-200-1 is manufactured to Collins specifications to allow "by the book" testing of the uut using Collins test procedures.

Manual Reference:

CTL-X2/X2A Fig. 5-1 / CTL-23 Fig. 903-904

Equipment Specifications:

Height: 7.00" Width: 5.50" Depth: 5.50"

Units Tested	Apple Software	PC Software
CTL-22/22A/22C	523-0773-212/523-0777-249	523-0777-533
CTL-23/23C	523-0777-506/523-0777-507	523-0777-532
CTL-32/32A	523-0773-213/523-0777-250	523-0777-534
CTL-62/62A	523-0773-214/523-0777-251	523-0777-535
CTL-92/92A	523-0773-215/523-0777-252	523-0777-536

Equipment Supplied:

ASI-200-1P	Overlay: ASI-2000 Test Points for CTL-X2/X2A
ASI-10-1A	Cable: ASI-200-1 TO CTL-22 Control Head
ASI-10-1B	Cable: ASI-200-1 TO CTL-62 Control Head
ASI-10-1C	Cable: ASI-200-1 TO CTL-92 Control Head

Optional Equipment

ASI-10-1D	Cable: ASI-200-1 TO CTL-23 Control Head
ASI-10-1D1	Cable: A6 Extender
ASI-10-1E	Cable: A2 Extender
ASI-10-1F	Cable: A3 Extender
ASI-10-1G	Cable: A1/A2/A6 Extender

ALL TEST SOFTWARE MUST BE PURCHASED DIRECT FROM COLLINS

VIR-30/31/32/33 Navigation Plug-In with OBS**ASI-200-2A**Description of Operation:

The ASI-200-2A, when used with the ASI-2000 and a computer, allows testing and repair of the Collins VIR-30/31/32/33 series of navigation receivers.

The plug-in is equipped with a heading synchro and a front panel connector for an external OBS source with a To-From meter such as an ASI-190() or Collins 479V-3

The ASI-200-2A is manufactured to Collins specifications to allow "by the book" testing of the uut using Collins test procedures.

Manual Reference:

VIR-32 Fig. 5-10 - 5-11

Equipment Specifications:

Height: 7.00" Width: 5.50" Depth: 5.50"

Units Tested	Apple Software	PC Software
VIR-30	Not Required	Not Required
VIR-31	Not Required	Not Required
VIR-32	523-0772-821/-906/523-0773-172	523-0777-554
VIR-33	523-0772-821/-906/523-0773-172	523-0777-554

Equipment Supplied:

ASI-200-2P	Overlay: ASI-2000 Test Points for VIR-30/31/32/33
------------	---

Optional Equipment

ASI-10-2A	Cable: ASI-200-2A to OBS source (ASI-160/-190)
ASI-10-2D	Cable: ASI-2000 to NAV-750() for manual control
ASI-10-2E	Cable: ASI-2000 to CTL-30 for manual control
ASI-10-2F	Cable: ASI-200-2A to 479V-3 (ASI-161)
ASI-10-2G	Cable: Collins 332C-10 to RMI-36 adapter
ASI-10-2H	Cable: ASI-200-2() to VIR-31-P3 and 332C-10
ASI-10-2K	Cable: A5P1 Extender
ASI-10-2L	Cable: A5P2 extender
ASI-10-2M	Cable: ASI-200-2() to CTL-32

ALL TEST SOFTWARE MUST BE PURCHASED DIRECT FROM COLLINS

VIR-30/31/32/33 Navigation Plug-In with OBS/HDG/To-From Meter**ASI-200-2B**Description of Operation:

The ASI-200-2B, when used with the ASI-2000 and a computer, allows testing and repair of the Collins VIR-30/31/32/33 series of navigation receivers.

The plug-in is equipped with a To-From meter, OBS resolver, and Heading synchro. The ASI-200-2B does not require an external OBS / HDG source panel.

The ASI-200-2B is manufactured to Collins specifications to allow "by the book" testing of the uut using Collins test procedures.

Manual Reference:

VIR-32 Fig. 5-10 - 5-11

Equipment Specifications:

Height: 7.00" Width: 5.50" Depth: 5.50"

Units Tested	Apple Software	PC Software
VIR-30	Not Required	Not Required
VIR-31	Not Required	Not Required
VIR-32	523-0772-821/-906/523-0773-172	523-0777-554
VIR-33	523-0772-821/-906/523-0773-172	523-0777-554

Equipment Supplied:

ASI-200-2P	Overlay: ASI-2000 Test Points for VIR-30/31/32/33
------------	---

Optional Equipment

ASI-10-2D	Cable: ASI-2000 to NAV-750() for manual control
ASI-10-2E	Cable: ASI-2000 to CTL-30 for manual control
ASI-10-2G	Cable: Collins 332C-10 to RMI-36 adapter
ASI-10-2H	Cable: ASI-200-2() to VIR-31-P3 and 332C-10
ASI-10-2K	Cable: A5P1 Extender
ASI-10-2L	Cable: A5P2 extender
ASI-10-2M	Cable: ASI-200-2() to CTL-32

REV 3
9-5-00
ALL TEST SOFTWARE MUST BE PURCHASED DIRECT FROM COLLINS

VIR-30/31/32/33 Navigation Plug-In with To-From Meter

ASI-200-2C

Description of Operation:

The ASI-200-2C, when used with the ASI-2000 and a computer, allows testing and repair of the Collins VIR-30/31/32/33 series of navigation receivers.

The plug-in is equipped with a To-From meter and a front panel connector for an ASI-160 external OBS and HDG source.

The ASI-200-2C is manufactured to Collins specifications to allow "by the book" testing of the uut using Collins test procedures.

Manual Reference:

VIR-32 Fig. 5-10 - 5-11

Equipment Specifications:

Height: 7.00" Width: 5.50" Depth: 5.50"

Units Tested

Units Tested	Apple Software	PC Software
VIR-30	Not Required	Not Required
VIR-31	Not Required	Not Required
VIR-32	523-0772-821/-906/523-0773-172	523-0777-554
VIR-33	523-0772-821/-906/523-0773-172	523-0777-554

Equipment Supplied:

ASI-200-2P Overlay: ASI-2000 Test Points for VIR-30/31/32/33

Optional Equipment

ASI-10-2C	Cable: ASI-200-2C to ASI-160B / ASI-160C
ASI-10-2D	Cable: ASI-2000 to NAV-750() for manual control
ASI-10-2E	Cable: ASI-2000 to CTL-30 for manual control
ASI-10-2F	Cable: ASI-200-2C to 479V-3 (ASI-161)
ASI-10-2G	Cable: Collins 332C-10 to RMI-36 adapter
ASI-10-2H	Cable: ASI-200-2() to VIR-31-P3 and 332C-10
ASI-10-2K	Cable: A5P1 Extender
ASI-10-2L	Cable: A5P2 extender
ASI-10-2M	Cable: ASI-200-2() to CTL-32

ALL TEST SOFTWARE MUST BE PURCHASED DIRECT FROM COLLINS

VIR-30/31/32/33 Navigation Plug-In

ASI-200-2D

Description of Operation:

The ASI-200-2D, when used with the ASI-2000 and a computer, allows testing and repair of the Collins VIR-30/31/32/33 series of navigation receivers.

The plug-in is equipped with a heading synchro and front panel connectors for an external OBS/HDG source with a To-From meter such as an ASI-160B or ASI-160C.

The ASI-200-2D is manufactured to Collins specifications to allow "by the book" testing of the uut using Collins test procedures.

Manual Reference:

VIR-32 Fig. 5-10 - 5-11

Equipment Specifications:

Height: 7.00" Width: 5.50" Depth: 5.50"

Units Tested

Units Tested	Apple Software	PC Software
VIR-30	Not Required	Not Required
VIR-31	Not Required	Not Required
VIR-32	523-0772-821/-906/523-0773-172	523-0777-554
VIR-33	523-0772-821/-906/523-0773-172	523-0777-554

Equipment Supplied:

ASI-200-2P Overlay: ASI-2000 Test Points for VIR-30/31/32/33

Optional Equipment

ASI-10-2A	Cable: ASI-200-2D to OBS source (ASI-160/-190)
ASI-10-2B	Cable: ASI-200-2D to ASI-160B/C
ASI-10-2D	Cable: ASI-2000 to NAV-750() for manual control
ASI-10-2E	Cable: ASI-2000 to CTL-30 for manual control
ASI-10-2F	Cable: ASI-200-2D to 479V-3 (ASI-161)
ASI-10-2G	Cable: Collins 332C-10 to RMI-36 adapter
ASI-10-2I	Cable: ASI-200-2D VIR-31, 332C-10, and ASI-140
ASI-10-2J	Cable: ASI-200-2D to VIR-31 and ASI-160B/C
ASI-10-2K	Cable: A5P1 Extender
ASI-10-2L	Cable: A5P2 extender
ASI-10-2M	Cable: ASI-200-2() to CTL-32

ALL TEST SOFTWARE MUST BE PURCHASED DIRECT FROM COLLINS

VHF-20/21/22 Communications Plug-In

ASI-200-3

Description of Operation:

The ASI-200-3, when used with the ASI-2000 and a computer, allows testing and repair of the Collins VHF-20/21/22 series of communications equipment.

The plug-in is equipped with a hardwired cable for the VHF-20/21/22. Optional cables provide manual testing of the VHF-21/22 if desired.

The ASI-200-3 is manufactured to Collins specifications to allow "by the book" testing of the uut using Collins test procedures.

Manual Reference:

VHF-21/22 Fig. 5-15

Equipment Specifications:

Height: 7.00" Width: 5.50" Depth: 5.50"

Units Tested

Units Tested	Apple Software	PC Software
VHF-20	Not Required	Not Required
VHF-21	523-0772-820/523-0772-901	523-0777-552
VHF-22	523-0772-820/523-0772-901	523-0777-552

Equipment Supplied:

ASI-200-3P Overlay: ASI-2000 Test Points for VHF-20/21/22

Optional Equipment

ASI-10-3A	Cable: ASI-2000 to Nav-750() for manual control
ASI-10-3B	Cable: ASI-2000 to CTL-20 for manual control
ASI-10-3C	Cable: ASI-2000 to NAV-760 for manual control
ASI-10-3D	Cable: ASI-200-3 to CTL-22

REV 3
9-5-00

ALL TEST SOFTWARE MUST BE PURCHASED DIRECT FROM COLLINS

CAD-31/62 Control Adapter Control Plug-In

ASI-200-4

Description of Operation:

The ASI-200-4, when used with the ASI-2000 and a computer, allows testing and repair of the Collins CAD-31/62 control adapters.

The Plug-in is equipped with a hardwired cable for the Collins CAD-31/62.

The ASI-200-4 is manufactured to Collins specifications to allow "by the book" testing of the uut using Collins test procedures.

Manual Reference:

CAD-31/62 Fig. 5-8 - 5-11

Equipment Specifications:

Height: 7.00" Width: 5.50" Depth: 5.50"

Units Tested

CAD-31
CAD-62

Apple Software

523-0774-353
523-0773-168

PC Software

523-0777-529
523-0777-528

Equipment Supplied:

ASI-200-4P Overlay: ASI-2000 Test Points for CTL-X2/X2A

Optional Equipment

ALL TEST SOFTWARE MUST BE PURCHASED DIRECT FROM COLLINS

DME-40/42 Plug-In

ASI-200-5

Description of Operation:

The ASI-200-5, when used with the ASI-2000 and a computer, allows testing and repair of the Collins DME-40, DME-42, and IND-42/42A/42C/42M.

The plug-in is equipped with hardwired cables for the DME-40/42, IND-42, and CTL-32. The DME simulator (ASI-200-5A1) is required when testing the DME-42.

The ASI-200-5 is manufactured to Collins specifications to allow "by the book" testing of the uut using Collins test procedures.

Manual Reference:

DME-42 Appendix D Fig. 1-2

Equipment Specifications:

Height: 7.00" Width: 5.50" Depth: 8.00"

Units Tested

DME-40
DME-42
IND-42A/C/M

Apple Software

Not Required
523-0773-211/-264/-265
523-0773-272

PC Software

Not Required
523-0777-540
523-0777-547

Equipment Supplied:

ASI-200-5P Overlay: ASI-2000 Test Points for VIR-30/31/32/33

Optional Equipment

ASI-10-5A Cable: ASI-200-5 to KEC-1030/Squawk Naut I
ASI-10-5B Cable: ASI-200-5 to CTL-30
ASI-10-5C Cable: ASI-200-5 to ATC-1400 (manual testing)
ASI-10-5D Cable: ASI-200-5 to IND-40/-41. 339F-12, 313N-4D
ASI-10-5E Cable: ASI-200-5 to ATC-1400 (computer testing)
ASI-200-5A1 DME Simulator Card (cpn 647-6787-001)

ALL TEST SOFTWARE MUST BE PURCHASED DIRECT FROM COLLINS

DME-42/442 Simulator Card

ASI-200-5A1

Description of Operation:

The ASI-200-5A1 (when used with the ASI-2000, ASI-200-5/-13, and a computer) aids in testing and repair of the Collins DME-42 and DME-442.

The ASI-200-5A1 simulates the operation of one or more ground station interrogations during testing of the DME-42/442.

The ASI-200-5A1 is manufactured to Collins specifications to allow "by the book" testing of the uut using Collins test procedures.

Manual Reference:

DME-42/42 Appendix D Fig. 6-7 (cpn 647-6787-001)

Equipment Specifications:

Height: 7.00" Width: 5.50" Depth: 5.50"

Units Tested

DME-42
DME-442

Apple Software

523-0773-211/-264/-265
523-0774-346/-347/-348

PC Software

523-0777-540
523-0777-541

Equipment Supplied:

Optional Equipment

ASI-200-5 Plug-In: ASI-2000 to DME-40/42
ASI-200-13 Plug-In: ASI-2000 to DME-442

ALL TEST SOFTWARE MUST BE PURCHASED DIRECT FROM COLLINS

REV 2
3-1-98

CTL-230 HF Control Plug-In**ASI-200-6**Description of Operation:

The ASI-200-6, when used with the ASI-2000 and a computer, allows testing and repair of the Collins CTL-230 HF control head.

The Plug-in is equipped with a hardwired cable to test the CTL-230.

The ASI-200-6 is manufactured to Collins specifications to allow "by the book" testing of the uut using Collins test procedures.

Manual Reference:

CTL-230 Fig. 5-2

Equipment Specifications:

Height: 7.00" Width: 5.50" Depth: 5.50"

Units Tested

CTL-230

Apple Software

523-0773-518

PC Software

TBA

Equipment Supplied:

ASI-200-6P Overlay: ASI-2000 Test Points for CTL-230

Optional Equipment

ALL TEST SOFTWARE MUST BE PURCHASED DIRECT FROM COLLINS

KFS Control Plug-In**ASI-200-7**Description of Operation:

The ASI-200-7, when used with the ASI-2000 and a computer, allows testing and repair of the King KFS series of control heads.

The ASI-200-7 is supplied with five adapter cables to test the KFS control heads. A KA-579A (ASI-71) power supply is required for testing.

The ASI-200-7 is manufactured to King specifications to allow "by-the book" testing of the uut using King test procedures.

Reference:

Replaces King KCA-110 kpn 071-5084-00

Equipment Specifications:

Height: 7.00" Width: 5.50" Depth: 5.50"

Units Tested

KFS-564/564A

KFS-576/576A

KFS-579/579A

KFS-586/586A

KFS-598/598A

Apple Software

222-0002-00

222-0005-00

222-0004-00

222-0003-00

222-0006-01

PC Software

N/A

N/A

N/A

N/A

N/A

Equipment Supplied:

ASI-200-7P Overlay: ASI-2000 Test Points for KFS Series

ASI-10-7A Cable: ASI-200-7 to KFS-564/564A

ASI-10-7B Cable: ASI-200-7 to KFS-576/576A

ASI-10-7C Cable: ASI-200-7 to KFS-579/579A

ASI-10-7D Cable: ASI-200-7 to KFS-586/586A

ASI-10-7E Cable: ASI-200-7 to KFS-598/598A

Optional Equipment

ASI-71 Power Supply (KA-579A)

ALL TEST SOFTWARE MUST BE PURCHASED DIRECT FROM KING

ARINC COM Plug-In**ASI-200-8**Description of Operation:

The ASI-200-8, when used with the ASI-2000, allows testing and repair of ARINC standard and other Communications equipment.

The ASI-200-8 is configured to expand shop capability in facilities already equipped with Linaire test panels. The ASI-200-8 utilizes all LT-5 and LA-5 cables.

Channeling may be incorporated by the addition of an ASI-500-1 control head simulator or with the optional cables listed to utilize other control sources.

Reference:

Substitutes for Linaire LT-5 / LA-5 panels

Equipment Specifications:

Height: 7.00" Width: 5.50" Depth: 5.50"

Units Tested

Various COM

Apple Software

N/A

PC Software

N/A

Equipment Supplied:

ASI-200-8P Overlay: ASI-2000 Test Points

Optional Equipment

ASI-10-8A Cable: ASI-2000 to CTL-20

ASI-10-8B Cable: ASI-2000 to LTC-1

ASI-10-8C Cable: ASI-2000 to NAV-750()

ASI-500-1 Control Head Simulator

REV 3
1-27-2020

ARINC NAV Plug-In**ASI-200-9**Description of Operation:

The ASI-200-9, when used with the ASI-2000, allows testing and repair of ARINC standard and other navigation equipment.

The ASI-200-9 is configured to expand shop capability in facilities already equipped with Linaire test panels. The ASI-200-9 utilizes all LV-5 cables.

Channeling may be incorporated by the addition of an ASI-500-1 control head simulator or with the optional cables listed to utilize other control sources.

Reference:

Substitutes for Linaire LV-5

Equipment Specifications:

Height: 7.00" Width: 5.50" Depth: 5.50"

Units Tested

Various NAV

Apple Software

N/A

PC Software

N/A

Equipment Supplied:

ASI-200-9P Overlay: ASI-2000 Test Points

Optional Equipment

ASI-10-9A	Cable: ASI-2000 to CTL-30
ASI-10-9B	Cable: ASI-2000 to LVC-4
ASI-10-9C	Cable: ASI-2000 to NAV-750()
ASI-10-9D	Cable: ASI-200-9 to VIR-130A
ASI-500-1	Control Head Simulator

ADF-60/462 Plug-In**ASI-200-10**Description of Operation:

The ASI-200-10, when used with the ASI-2000 and a computer, allows testing and repair of the Collins ADF-60 and ADF-462.

The plug-in is equipped with hardwired cables for the ADF-60, ADF-462, and a control (614L-11/12/13 or ASI-500-1). A loop antenna or simulator (ASI-61 or 970W-1) and RMI indicator are required for operation.

The ASI-200-10 is manufactured to Collins specifications to allow "by the book" testing using Collins procedures.

Manual Reference:

ADF-60 Fig. 6-1 / ADF-462 Fig. 5-7

Equipment Specifications:

Height: 7.00" Width: 5.50" Depth: 5.50"

Units Tested

ADF-60

ADF-462

Apple Software

Not Required

523-0774-019/047/433/434/435

PC Software

Not Required

523-0777-526

Equipment Supplied:

ASI-200-10P	Overlay: ASI-2000 Test Points for ADF-60/462
ASI-10-10A	Cable: ASI-200-10 to ASI-61, 970W-1 or ANT-60A
ASI-10-10B	Cable: ASI-200-10 to RMI-36

Optional Equipment

ASI-10-10C	Cable: ASI-200-10 to 332C-10
ASI-10-10D	Cable: ASI-2000 to CTL-62
ASI-10-10E	Cable: ASI-200-10 to ASI-160/-160B/-160C
ASI-10-10F	Cable: ASI-200-10 to 699Z-1 and 332C-10
ASI-61	ADF Loop Antenna Simulator (Replaces 970W-1)
ASI-278	ADF Loop Antenna Tester (969W-1)
ASI-500-1	Control Head Simulator

ALL TEST SOFTWARE MUST BE PURCHASED DIRECT FROM KING

VHF-422 Communication Plug-In**ASI-200-11**Description of Operation:

The ASI-200-11, when used with the ASI-2000 and a computer, allows testing and repair of the Collins VHF-422.

The plug-in is equipped with a hardwired cable for the VHF-422.

The ASI-200-11 is manufactured to Collins specifications to allow "by the book" testing of the uut using Collins test procedures.

Manual Reference:

VHF-422 Fig. 5-15

Equipment Specifications:

Height: 7.00" Width: 5.50" Depth: 5.50"

Units Tested

Various COM

Apple Software

523-0774-352/374/375

PC Software

523-0777-553

Equipment Supplied:

ASI-200-11P Overlay: ASI-2000 Test Points for VHF-422

Optional Equipment

ASI-10-11A Cable: ASI-2000 to CTL-22

REV 3
1-27-2020

ALL TEST SOFTWARE MUST BE PURCHASED DIRECT FROM COLLINS

VIR-432/433 Navigation Plug-In

ASI-200-12

Description of Operation:

The ASI-200-12, when used with the ASI-2000 and a computer, allows testing and repair of the Collins VIR-432 and VIR-433.

The Plug-in is equipped with a hardwired cable for the VIR-432/433. An optional cable for manual testing with a CTL-32 is available.

The ASI-200-12 is manufactured to Collins specifications to allow "by the book" testing of the uut using Collins test procedures.

Manual Reference:

VIR-432/433 Fig. 5-6

Equipment Specifications:

Height: 7.00" Width: 5.50" Depth: 5.50"

Units Tested

VIR-432
VIR-433

Apple Software

523-0774-216/217/218
523-0774-216/217/218

PC Software

523-0777-555
523-0777-555

Equipment Supplied:

ASI-200-12P Overlay: ASI-2000 Test Points for VIR-432/433

Optional Equipment

ASI-10-12A Cable: ASI-2000 to CTL-32

ALL TEST SOFTWARE MUST BE PURCHASED DIRECT FROM COLLINS

DME-442 Plug-In

ASI-200-13

Description of Operation:

The ASI-200-13, when used with the ASI-2000 and a computer, allows testing and repair of the Collins DME-442

The plug-in is equipped with hardwired cables for the DME-442, IND-42, and CTL-32. The DME simulator (ASI-200-5A1) is required for testing the DME-442.

The ASI-200-13 is manufactured to Collins specifications to allow "by the book" testing of the uut using Collins test procedures.

Manual Reference:

DME-442 Appendix D Fig. 2

Equipment Specifications:

Height: 7.00" Width: 5.50" Depth: 8.00"

Units Tested

DME-442

Apple Software

523-0774-346/347/348

PC Software

523-0777-541

Equipment Supplied:

ASI-200-13P Overlay: ASI-2000 Test Points for DME-442

Optional Equipment

ASI-200-5A1 DME Simulator Card (cpn 647-6787-001)

ALL TEST SOFTWARE MUST BE PURCHASED DIRECT FROM COLLINS

TDR-90/CAD-870G Plug-In

ASI-200-14

Description of Operation:

The ASI-200-14, when used with the ASI-2000 and a computer, allows testing and repair of the Collins TDR-90 and CAD-870G.

The plug-in is equipped with hardwired cables for the TDR-90 and CAD-870G. Manual control may be provided by an ASI-500-1 or optional cables listed.

The ASI-200-14 is manufactured to Collins specifications to allow "by the book" testing of the uut using Collins test procedures.

Manual Reference:

CAD-870G Fig. 5-6

Equipment Specifications:

Height: 7.00" Width: 5.50" Depth: 5.50"

Units Tested

TDR-90
CAD-870G

Apple Software

Not Required
523-0775-916

PC Software

Not Required
523-0777-531

Equipment Supplied:

ASI-200-14P Overlay: ASI-2000 Test Points

Optional Equipment

ASI-10-14A Cable: ASI-2000 to 613L-3
ASI-10-14B Cable: ASI-2000 to ASI-500-1
ASI-10-14C Cable: ASI-2000 to CTL-90
ASI-10-14D Cable: ASI-2000 to CAD-62/CTL-92
ASI-500-1 Control Head Simulator

REV 2
3-1-98

ALL TEST SOFTWARE MUST BE PURCHASED DIRECT FROM COLLINS

DDA-42 Plug-In**ASI-200-15**Description of Operation:

The ASI-200-15, when used with the ASI-2000 and a computer, allows testing and repair of the Collins DDA-42.

The Plug-in is equipped with hardwired cables for the DDA-42 and an indicator (IND-40, IND-41, or 339F-12).

The ASI-200-15 is manufactured to Collins specifications to allow "by the book" testing of the uut using Collins test procedures.

Manual Reference:

DDA-42 Fig. 5-3

Equipment Specifications:

Height: 7.00" Width: 5.50" Depth: 5.50"

Units Tested

DDA-42

Apple Software

523-0774-035

PC Software

TBA

Equipment Supplied:

ASI-200-15P Overlay: ASI-2000 Test Points for DDA-42

Optional Equipment

ALL TEST SOFTWARE MUST BE PURCHASED DIRECT FROM COLLINS

KDM-706A Plug-In**ASI-200-16**Description of Operation:

The ASI-200-16, when used with the ASI-2000 and a computer, allows testing and repair of the King KDM-706A.

The plug-in is equipped with hardwired cables for the KDM-706A.

The ASI-200-16 is manufactured to King specifications to allow "by the book" testing of the uut using King test procedures.

Reference:

Replaces King KCA-160 kpn 071-5113-00

Equipment Specifications:

Height: 7.00" Width: 5.50" Depth: 5.50"

Units Tested

KDM-706A

Apple Software

222-0120-00

PC Software

N/A

Equipment Supplied:

ASI-200-16P Overlay: ASI-2000 Test Points for KDM-706A

Optional Equipment

ALL TEST SOFTWARE MUST BE PURCHASED DIRECT FROM KING

RTU-870A/870T Plug-In**ASI-200-17A**Description of Operation:

The ASI-200-17A, when used with the ASI-2000 and a computer, allows testing and repair of the Collins RTU-870A and RTU-870T.

The plug-in is equipped with hardwired cable for the RTU-870A/870T.

The ASI-200-17A is manufactured to Collins specifications to allow "by-the book" testing of the uut using Collins test procedures.

Manual Reference:

RTU-870A/870T Fig. 901

Equipment Specifications:

Height: 7.00" Width: 5.50" Depth: 5.50"

Units Tested

RTU-870A

RTU-870T

Apple Software

523-0776-895

523-0776-974

PC Software

523-0777-550

523-0777-550

Equipment Supplied:

ASI-200-17P Overlay: ASI-2000 Test Points for RTU-870A/T

Optional Equipment

ASI-10-17A-A2 Cable: Extender No. 1 Display Driver Card (A2)

ASI-10-17A-A3 Cable: Extender No. 2 Display Driver Card (A3)

REV 2
3-1-98

ALL TEST SOFTWARE MUST BE PURCHASED DIRECT FROM COLLINS

CAD-870/RAC-870 Plug-In

ASI-200-18

Description of Operation:

The ASI-200-18, when used with the ASI-2000 and a computer, allows testing and repair of the Collins CAD-870 and RAC-870.

The Plug-in is equipped with a hardwired cable for the CAD-870 and RAC-870.

The ASI-200-18 is manufactured to Collins specifications to allow "by the book" testing of the uut using Collins test procedures.

Manual Reference:

CAD-870 Fig 5-4 - 5-5 / RAC-870 Fig. 5-5 - 5-6

Equipment Specifications:

Height: 7.00" Width: 5.50" Depth: 5.50"

Units Tested

CAD-870
RAC-870

Apple Software

523-0774-244
523-0774-342

PC Software

523-0777-530
523-0777-549

Equipment Supplied:

ASI-200-18P Overlay: ASI-2000 Test Points for CAD/RAC-870

Optional Equipment

ALL TEST SOFTWARE MUST BE PURCHASED DIRECT FROM COLLINS

BIA-32 Plug-In

ASI-200-19

Description of Operation:

The ASI-200-19, when used with the ASI-2000 and a computer, allows testing and repair of the Collins BIA-32

The plug-in is equipped with hardwired cable for the BIA-32 and a RMI (RMI-36 or BDI-36) cable. An optional cable for a RMI-30 is available.

The ASI-200-19 is manufactured to Collins specifications to allow "by the book" testing of the uut using Collins test procedures.

Manual Reference:

BIA-32 Fig. 5-7

Equipment Specifications:

Height: 7.00" Width: 5.50" Depth: 5.50"

Units Tested

BIA-32

Apple Software

523-0775-431

PC Software

TBA

Equipment Supplied:

ASI-200-19P Overlay: ASI-2000 Test Points for DME-442
ASI-10-19B Cable: ASI-200-19 to RMI-36 or BDI-36

Optional Equipment

ASI-10-19A Cable: ASI-200-19 to RMI-30

ALL TEST SOFTWARE MUST BE PURCHASED DIRECT FROM COLLINS

ALT-50A/55B/860F-2 Plug-In

ASI-200-20

Description of Operation:

The ASI-200-20, when used with the ASI-2000, allows testing and repair of the Collins ALT-50A, ALT-55B, and 860F-2.

The plug-in is equipped with hardwired cables for the ALT-50A/55B/860F-2 and indicator (ALI-55/55A/55B/339H-4/4A).

The ASI-200-20 is manufactured to Collins specifications to allow "by the book" testing of the uut using Collins test procedures.

Manual Reference:

ALT-50A/55B Fig. 5-1

Equipment Specifications:

Height: 7.00" Width: 5.50" Depth: 5.50"

Units Tested

ALT-50A
ALT-55B
860F-2

Apple Software

Not Required
Not Required
Not Required

PC Software

Not Required
Not Required
Not Required

Equipment Supplied:

ASI-200-20P Overlay: ASI-2000 Test Points

Optional Equipment

REV 2
3-1-98

CTL-X0/X1 Plug-In**ASI-200-21**Description of Operation:

The ASI-200-21, when used with the ASI-2000, allows testing and repair of the Collins CTL-20/21, CTL-30/31, CTL-60/61, CTL-90/91.

The Plug-in is equipped with a hardwired cable for the CTL-X0/X1 Control.

The ASI-200-21 is manufactured to Collins specifications to allow "by the book" testing of the uut using Collins test procedures.

Manual Reference:

CTL-X0 Fig. 5-6 (Replaces CTS-231 cpn 622-5188-001)

Equipment Specifications:

Height: 7.00" Width: 5.50" Depth: 5.50"

Units Tested

CTL-20/21
CTL-30/31
CTL-60/61
CTL-90/91

Apple Software

Not Required
Not Required
Not Required
Not Required

PC Software

Not Required
Not Required
Not Required
Not Required

Equipment Supplied:

ASI-200-21P Overlay: ASI-2000 Test Points for CTL-X0/X1

Optional Equipment**BRG-40 Plug-In****ASI-200-22**Description of Operation:

The ASI-200-22, when used with the ASI-2000, allows testing and repair of the Collins BRG-40.

The plug-in is equipped with hardwired cables for the BRG-40 and a 332C-10/10B indicator. A track selector (ASI-190 or 479V-3) is required for testing.

The ASI-200-22 is manufactured to Collins specifications to allow "by the book" testing of the uut using Collins test procedures.

Manual Reference:

BRG-40 Maintenance Fig. 2

Equipment Specifications:

Height: 7.00" Width: 5.50" Depth: 5.50"

Units Tested

BRG-40

Apple Software

Not Required

PC Software

Not Required

Equipment Supplied:

ASI-200-22P Overlay: ASI-2000 Test Points for BRG-40

Optional Equipment

ASI-190/-190B Universal Precision Track Selector
ASI-161 Universal Precision Track Selector (479V-3)

ARINC Glide Slope Plug-In**ASI-200-23**Description of Operation:

The ASI-200-23 when used with the ASI-2000, allows testing and repair of ARINC standard and other glide slope equipment.

The ASI-200-23 is configured to expand shop capability in facilities already equipped with Linaire test panels. This plug-in will work with all LG-4 test cables.

Reference:

Substitutes for Linaire LG-4

Equipment Specifications:

Height: 7.00" Width: 5.50" Depth: 5.50"

Units Tested

Various GS

Apple Software

N/A

PC Software

N/A

Equipment Supplied:

ASI-200-23P Overlay: ASI-2000 Test Points

Optional Equipment

REV 3
1-27-2020

ARINC DME Plug-In

ASI-200-24

Description of Operation:

The ASI-200-24 when used with the ASI-2000, allows testing and repair of ARINC standard and other DME equipment.

The ASI-200-24 is configured to expand shop capability in facilities already equipped with Linaire test panels. This plug-in will work with all LD-4 test cables.

Units Tested

Various DME

Apple Software

N/A

PC Software

N/A

Equipment Supplied:

ASI-200-24P Overlay: ASI-2000 Test Points

Optional EquipmentReference:

Substitutes for Linaire LD-4

Equipment Specifications:

Height: 7.00" Width: 5.50" Depth: 5.50"

ARINC Transponder Plug-In

ASI-200-25

Description of Operation:

The ASI-200-25 when used with the ASI-2000, allows testing and repair of ARINC standard and other transponder equipment.

The ASI-200-25 is configured to expand shop capability in facilities already equipped with Linaire test panels. This plug-in will work with all LX-3B test cables.

Units TestedVarious
TranspondersApple Software

N/A

PC Software

N/A

Equipment Supplied:

ASI-200-25P Overlay: ASI-2000 Test Points

Optional EquipmentReference:

Substitutes for Linaire LX-3B

Equipment Specifications:

Height: 7.00" Width: 5.50" Depth: 5.50"

ARINC Marker Beacon Plug-In

ASI-200-26

Description of Operation:

The ASI-200-26 when used with the ASI-2000, allows testing and repair of ARINC standard and other marker beacon equipment.

The ASI-200-26 is configured to expand shop capability in facilities already equipped with Linaire test panels. This plug-in will work with all LM-3 test cables.

Units TestedVarious
Marker BeaconApple Software

N/A

PC Software

N/A

Equipment Supplied:

ASI-200-26P Overlay: ASI-2000 Test Points

Optional EquipmentReference:

Substitutes for Linaire LM-3

Equipment Specifications:

Height: 7.00" Width: 5.50" Depth: 5.50"

REV 3
1-27-2020

CTL-92T Plug-In

ASI-200-27

Description of Operation:

The ASI-200-27, when used with the ASI-2000 and a computer (PC), allows testing and repair of the Collins CTL-92T TCAS Control Head.

The Plug-in is equipped with a hardwired cable for the CTL-92T.

The ASI-200-27 is manufactured to Collins specifications to allow "by-the book" testing of the uut using Collins test procedures.

Manual Reference:

CTL-92T Fig. 901-903

Equipment Specifications:

Height: 7.00" Width: 5.50" Depth: 5.50"

Units Tested

CTL-92T

Apple Software

(Will not run with Apple)

PC Software

523-0777-537

Equipment Supplied:

ASI-200-27P Overlay: ASI-2000 Test Points for CTL-92T

Optional Equipment

ASI-10-1D1 Cable: A6 Extender
ASI-10-1E Cable: A2 Extender
ASI-10-1F Cable: A3 Extender
ASI-10-1G Cable: A1/A2/A6 Extender

ALL TEST SOFTWARE MUST BE PURCHASED DIRECT FROM COLLINS

ASI-2000 Test Adapter Plug-In

ASI-200-28

Description of Operation:

The ASI-200-28 allows complete testing of the ASI-2000 mainframe and associated computer equipment.

The plug-in tests all functions of the mainframe including connectors J2/J3/P3, test jacks, and main connector.

The ASI-200-28 also tests the Collins Apple software package, Collins CSDB-402 Pro Line II computer interface card (653-1154-001), and computer cables.

Manual Reference:

Equipment Specifications:

Height: 7.00" Width: 5.50" Depth: 5.50"

Units Tested

ASI-2000

Apple Software

523-0772-900

PC Software

523-0777-548

Equipment Supplied:

ASI-200-28P Overlay: ASI-2000 Test Points
ASI-200-28A2 Test Point Test Board
ASI-10-28A Ribbon Cable (25S/25S 60.0")

Optional Equipment

ALL TEST SOFTWARE MUST BE PURCHASED DIRECT FROM COLLINS

ADF Test Set

ASI-201-1

OEM: Rockwell Collins
 MN: AN/ARM-93
 PN: 522-4458-001
 Manual: TM 11-6625-821-12 Fig: 1-1

UUT: AN/ARN-83 / R1391 / C-6899
 Size: H: 15.00" W: 15.50" D: 14.00"
 Pwr: 28 VDC

Description:

The ASI-201-1 ADF Test Set, when used with other standard test equipment, provides a complete portable test station for the AN/ARN-83 ADF System. The Test Set is housed in a rugged transit / storage case, but it can also be easily removed and installed in a standard 19" rack. A user supplied 614L-8 / C-6899/ARN-83 Control is required for proper operation of the Test Set.

The ASI-201-1 (AN/ARM-93) is the military version of the ASI-201-2 (477U-3) and is identical in form, fit, and function. The only difference is the model number and part number stamped on the identification tag.

Equipment Supplied:

ASI MN	OEM PN	Description
ASI-20-11A	762-1551-001	RF Input Cable (CG-2794)
ASI-20-11B	762-1561-001	Inverter Servicing Cable (CX-11571)
ASI-20-11C	549-6545-004	Loop Antenna Cable (CX-11570)
ASI-20-11D	792-1667-001	Low Cap Sense Adapter Cable (SM-466)
ASI-20-11E	762-1499-003	ADF Loop Antenna Test Fixture (MT-3667)
ASI-20-11F	762-1496-001	DC Power Cable (CX-11569)
ASI-201-1TS	762-1675-001	ADF Test Set (TS-2502)

Optional Equipment:

ASI MN	OEM PN	Description
ASI-19-2D	554-6109-004	Low Cap Sense Adapter Cable (ASI-20-1D)
ASI-192	522-2710-000	ADF Antenna Simulator (477U-2)
ASI-193	522-2711-002	ADF Test Panel (477V-2)

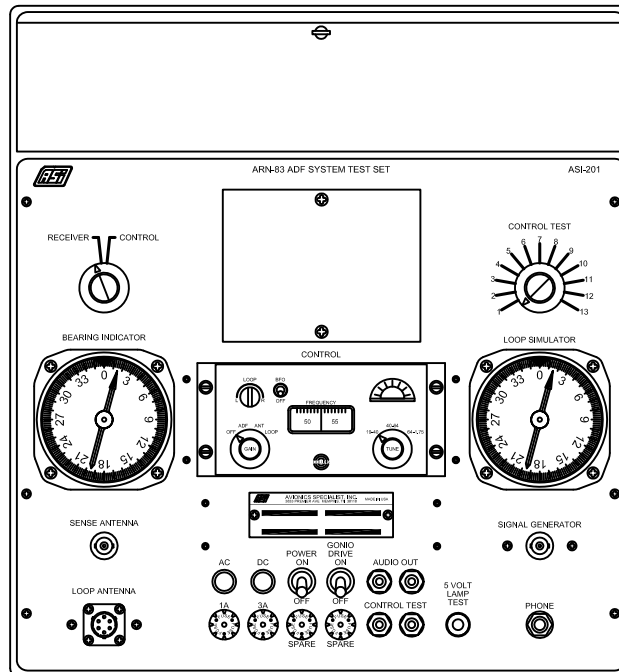

ADF Test Set

ASI-201-2

OEM: Rockwell Collins
 MN: 477U-3
 PN: 522-4458-002
 Manual: 523-0758573 Fig: 1-1

UUT: DF-203 / 51Y-4/4A / 614L-8
 Size: H: 15.00" W: 15.50" D: 14.00"
 Pwr: 28 VDC

Description:

The ASI-201-2 ADF Test Set, when used with other standard test equipment, provides a complete portable test station for the DF-203 ADF System. The Test Set is housed in a rugged transit / storage case, but it can also be easily removed and installed in a standard 19" rack. A user supplied 614L-8 / C-6899/ARN-83 Control is required for proper operation of the Test Set.

The ASI-201-2 (477U-3) is the commercial version of the ASI-201-1 (AN/ARM-93) and is identical in form, fit, and function. The only difference is the model number and part number stamped on the identification tag. See ASI-201-1 for picture of ASI-201-2.

Equipment Supplied:

ASI MN	OEM PN	Description
ASI-20-1A	762-1551-002	RF Input Cable
ASI-20-1B	762-1561-002	Inverter Servicing Cable
ASI-20-1C	549-6545-004	Loop Antenna Cable
ASI-20-1D	792-1667-002	Low Cap Sense Adapter Cable
ASI-20-1E	762-1499-004	ADF Loop Antenna Test Fixture
ASI-20-1F	762-1496-002	DC Power Cable

Optional Equipment:

ASI MN	OEM PN	Description
ASI-19-2D	554-6109-004	Low Cap Sense Adapter Cable (ASI-20-1D)
ASI-192	522-2710-000	ADF Antenna Simulator (477U-2)
ASI-193	522-2711-002	ADF Test Panel (477V-2)

ADF System Test Panel

ASI-202-1

OEM: Honeywell Bendix
 MN: DFT-73AA
 PN: 2064943-0501
 Manual: I.B.1073F
 Fig: 1

UUT: DFA-73A/73AA/73A1/74A
 CNA-73A/73B/73BB/73C/73CB
 CNA-73D/73E/73FB/FC/FD
 Size: H: 12.25" W: 19.00" D: 10.00"
 Pwr: 115 VAC 400 Hz / 28 VDC

Description:

The ASI-202-1 ADF System Test Panel facilitates testing, troubleshooting, and alignment of the Bendix DFA-73() ADF Receivers and the CNA-73() Control. The Test Panel comes equipped with an ADF Bearing Indicator but it does require a user supplied CNA-73() ADF Control for proper operation.

Equipment Supplied:

ASI MN	OEM PN	Description
ASI-20-2A	2064756-0501	DFA-73/74 Cable (W101)
ASI-20-2B	2065211-0501	Sense Cable (W102)
ASI-20-2C	2064754-0501	Loop Cable (W103)

Optional Equipment:

ASI MN	OEM PN	Description
ASI-20-2D	2065171-0501	CNA-73CB/FC/FD Cable (W106)
ASI-20-2E	2065171-0502	CNA-73FB Cable (W107)

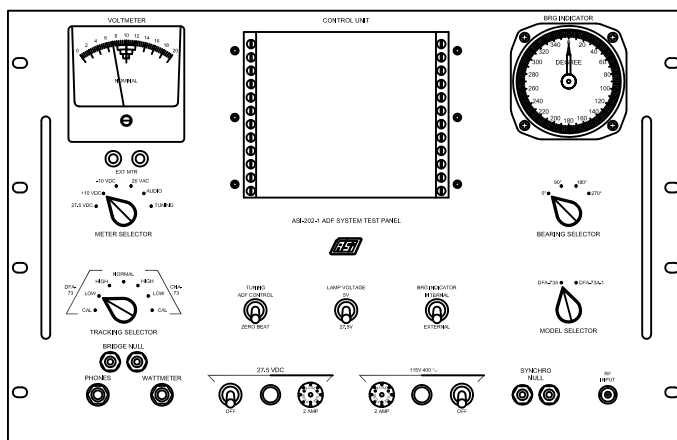

ADF System Test Panel

ASI-202-2

OEM: Honeywell Bendix
 MN: DFT-73C1
 PN: 2070555-0501
 Manual: T.O.33D2-8-267-22
 Fig: 1

UUT: DFA-73AC/73AF
 CNA-73BC/73BF
 Size: H: 12.25" W: 19.00" D: 10.00"
 Pwr: 115 VAC 400 Hz / 28 VDC

Description:

The ASI-202-2 ADF System Test Panel facilitates testing, troubleshooting, and alignment of the Bendix DFA-73AC/73AF ADF Receivers and the CNA-73BC/73BF Control. The Test Panel comes equipped with an ADF Bearing Indicator but it does require a user supplied CNA-73() ADF Control for proper operation.

Equipment Supplied:

ASI MN	OEM PN	Description
ASI-20-2A	2064756-0501	DFA-73/74 Cable (W101)
ASI-20-22B	2065211-0503	Sense Cable (W102)
ASI-20-22C	2064754-0503	Loop Cable (W103)

Optional Equipment:

ASI MN	OEM PN	Description
--------	--------	-------------

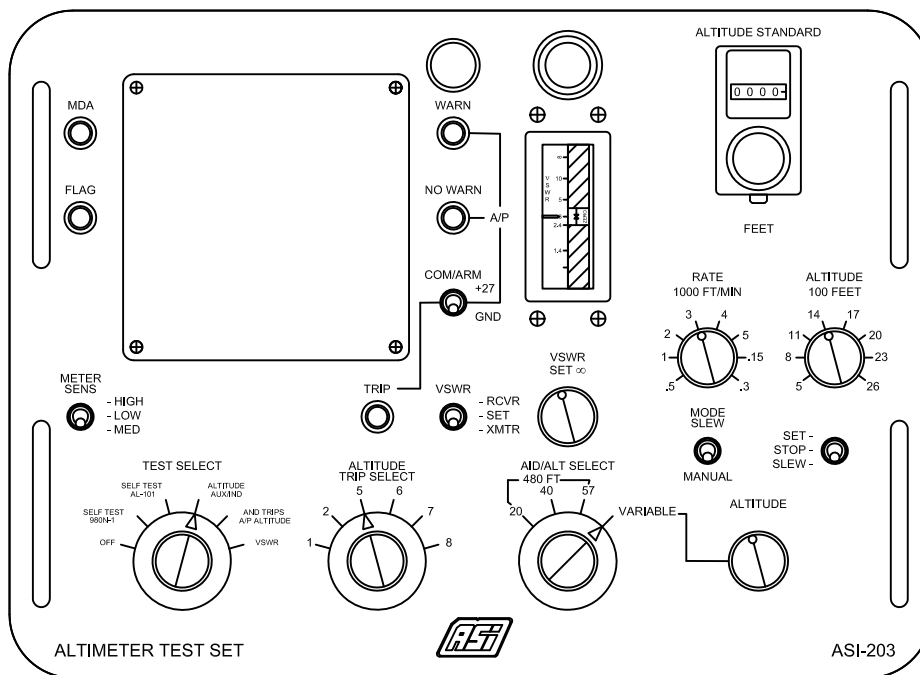

OEM Equivalent:
 OEM: Rockwell Collins
 Model Number: 980N-1
 Part Number: 522-4610-004
 Manual: 523-0759341
 Manual Figure:

Units Tested:
 AL-101 / AL-101A
 860F-1 / 860F-4
 339H-1 / 339H-2 / 339H-5 / 339H-6

This unit is manufactured to replace the OEM MN, PN, and/or manual figure listed in Form, Fit, and Function.

Description:
 The ASI-203 is used to isolate faults and perform routine flight-line maintenance tests on the AL-101/-101A Radio Altimeter Systems. The test set requires a user supplied 339H-1 () Indicator for proper operation.
 The ASI-203 can be used for functional bench checks of the Collins 860F-1/-4 Receiver-Transmitter and the 339H-() indicator.
 The ASI-203 also provides capability to test the ground proximity warning system (GPWS).
 The ASI-203 is enclosed in a 2-piece rugged drawn-aluminum case.

Equipment Supplied:
[ASI MN](#) [OEM PN](#) [Description](#)

The ASI-203-M1K Meter Retrofit Kit (listed in the optional equipment section) is a replacement meter for the Collins 980N-1 meter (cpn 458-0815-040) which is no longer available. The ASI-203-M1K mounts in place of the obsolete meter and requires no modification of the 980N-1 faceplate.

Optional Equipment:

ASI MN	OEM PN	Description
ASI-20-3A		980N-1 (ASI-203) Dual Adapter
ASI-20-3B		AL-101 Man Fig 512-153/AL-101A Man Fig 503-504
ASI-20-3C		980N-1 (ASI-203) Triplex Adapter
ASI-210		AL-101 Man Fig 514-515/AL-101A Man Fig 505-506
ASI-203-M1K		Dual System Ramp Tester Adapter Cable
		AL-101 Man Fig 511
		AL-101 Radio Altimeter System Ramp Test Fixture
		AL-101 Man Fig 510A-510F
		980N-1 Meter Retrofit Kit (replaces existing meter)

Specifications:
 Height: 11.50" Width: 11.00" Depth: 8.00"
 Power Requirements: Supplied by UUT

Test Bench Harness

ASI-207

OEM Equivalent: Rockwell Collins MN: 477W-7 PN: 622-0158-001 Manual: 523-0764501 Manual Figure: 1	UUT: 490S-1
	Size: H: 10.50" W: 19.00" D: 10.00" Pwr: 115 VAC 400 Hz 3 Phase / 28 VDC

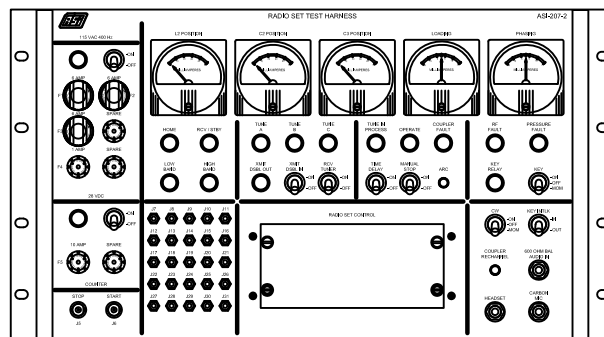

Description:
The ASI-207 Test Bench Harness provides capability to test the 490S-1 Antenna Coupler at full rated power levels and permits hot mockup operation of the entire coupler system. The ASI-207 includes the ASI-207-1 Dummy Load, ASI-207-2 Test Set and associated interconnect cables.

Testing of the 490S-1 requires the use of a known good HF Control (714E-2/3/6) and HF Transceiver (618T-X or 628T-X). If the 628T-X is used then a 999W-X Adapter is required to interface it to the ASI-207-2 (W3). Use of the 628T-1/1A requires a 999W-1/1A, the 628T-2/2A requires a 999W-2/2A, and the 628T-3/3A requires a 999W-3/3A. The ASI-207 may also be used in conjunction with the ASI-700-4 to test the 490S-1. Testing with the ASI-700-4 also requires an HF Control (714E-2/3/6 / HFP-702/712) and HF Transceiver (628T-2/2A / HFS-700/900/900D). Refer to the 490S-1 manual for more detailed test set up information.

Equipment Supplied:		
<u>ASI MN</u>	<u>OEM PN</u>	<u>Description</u>
ASI-207-1	622-0180-001	Dummy Antenna Shunt (172H-18)
ASI-207-2	622-0304-001	Radio Test Set Harness (678P-5)
ASI-20-7A	617-9756-001	Cable: ASI-207-2 to 490S-1 (W1)
ASI-20-7B	617-9758-001	Cable: ASI-207-2 to 490S-1 (W2)
ASI-20-7C	617-9755-001	Cable: ASI-207-2 to 618T-X (W3)
ASI-20-7D	618-7711-001	Cable: 618T-X to Wattmeter (W4)
ASI-20-7E	618-7712-001	Cable: 490S-1 to Wattmeter (W5)
ASI-20-7F	617-9743-001	Cable: ASI-207-2 to Dc Power Supply
ASI-20-7G	757-8979-001	Cable: ASI-207-2 to AC Power Supply

Optional Equipment:		
<u>ASI MN</u>	<u>OEM PN</u>	<u>Description</u>
ASI-20-7H	NPN	Transmitter Gain Control
ASI-208	777-1526-001	Antenna Coupler Test Set (980H-5)
ASI-208-1	622-0226-001	Discriminator Test Panel (878L-19D)
ASI-208-3	622-0227-001	Servo-Power Supply Test Panel (878L-39)
ASI-208-4	622-0228-001	Tuner-Chassis Test Panel (878L-40)
ASI-208-5	622-0229-001	Logic Card Test Set (878L-41)
ASI-235	NPN	Special Solder Tip
ASI-700-4	NPN	HF/VHF Discrete Function Interface Unit
ASI-711	NPN	500 Ohm T-Attenuator

Dummy Antenna Shunt

ASI-207-1

OEM Equivalent: Rockwell Collins MN: 172H-18 PN: 622-0180-001 Manual: 523-0764501 Manual Figure: 1	UUT: 490S-1 / 490S-4 / CPL-920D HF-9040 / HF-9041 / HF-9042 CU-2314(V)1/-2/-3/-4
	Size: H: 10.70" W: 13.70" D: 30.75" Pwr: 115 VAC 60 Hz

Description:
The ASI-207-1 Dummy Antenna Shunt, part of the ASI-207 Test Bench Harness, simulates an aircraft shunt or notch antenna. The ASI-207-1 is required when testing various Collins HF Antenna Couplers including the 490S-1, 490S-2, CPL-920D, CU-2314(V)-1/-2/-3/-4, HF-9040, HF-9041, and HF-9042. The Dummy Antenna Shunt may be used with HF radio systems operating from 2 MHz - 30 MHz with a power rating up to 400 W average and 1000 W pep.

The ASI-207-1 (172H-18) is also functionally equivalent to the Rockwell Collins 172H-18A / 622-7148-001 Dummy Antenna Shunt.

The optional ASI-207-3 is required to interface the CPL-920D with enhanced lightning protection (822-0987-004) to the ASI-207-1 (172H-18).

Equipment Supplied:		
<u>ASI MN</u>	<u>OEM PN</u>	<u>Description</u>
ASI-207-3	NPN	RF High Volt Fixture for CPL-920D (-004-020)
ASI-207-13	652-2443-001	RF Test Adapter
ASI-208	777-1526-001	Antenna Coupler Test Set (980H-5)
ASI-208-1	622-0226-001	Discriminator Test Panel (878L-19D)
ASI-208-3	622-0227-001	Servo-Power Supply Test Panel (878L-39)
ASI-208-4	622-0228-001	Tuner-Chassis Test Panel (878L-40)
ASI-208-5	622-0229-001	Logic Card Test Set (878L-41)
ASI-235	NPN	Special Solder Tip
ASI-323-2	622-7574-001	Test Set for AN/ARC-190(V) System (966D-5A)
ASI-323-21	622-7574-002	Test Set for AN/ARC-190(V) System (966D-5A)
ASI-323-3	622-9034-001	Test Set for AN/ARC-190(V) System (966D-5B)
ASI-700-4	NPN	HF/VHF Discrete Function Interface Unit
ASI-700-04C	NPN	ARINC-753 HF/DFL Voice Interface Fixture
ASI-711	NPN	500 Ohm T-Attenuator
ASI-777	822-1429-001	Test Set for HF-9000 System (TE-9210)

Dummy Antenna Shunt

ASI-207-1-220

OEM Equivalent: Rockwell Collins MN: 172H-18 PN: 622-0180-001 Manual: 523-0764501 Manual Figure: 1	UUT: 490S-1 / 490S-4 / CPL-920D HF-9040 / HF-9041 / HF-9042 CU-2314(V)1/-2/-3/-4
	Size: H: 10.70" W: 13.70" D: 30.75" Pwr: 220 VAC 50-60 Hz

Description:
The ASI-207-1-220 is identical to the ASI-207-1 except that it operates on 220 VAC 50-60 Hz input power.

Equipment Supplied:		
<u>ASI MN</u>	<u>OEM PN</u>	<u>Description</u>
ASI-207-3	NPN	RF High Volt Fixture for CPL-920D (-004-020)
ASI-207-13	652-2443-001	RF Test Adapter
ASI-208	777-1526-001	Antenna Coupler Test Set (980H-5)
ASI-208-1	622-0226-001	Discriminator Test Panel (878L-19D)
ASI-208-3	622-0227-001	Servo-Power Supply Test Panel (878L-39)
ASI-208-4	622-0228-001	Tuner-Chassis Test Panel (878L-40)
ASI-208-5	622-0229-001	Logic Card Test Set (878L-41)
ASI-235	NPN	Special Solder Tip
ASI-323-2	622-7574-001	Test Set for AN/ARC-190(V) System (966D-5A)
ASI-323-21	622-7574-002	Test Set for AN/ARC-190(V) System (966D-5A)
ASI-323-3	622-9034-001	Test Set for AN/ARC-190(V) System (966D-5B)
ASI-700-4	NPN	HF/VHF Discrete Function Interface Unit
ASI-700-04C	NPN	ARINC-753 HF/DFL Voice Interface Fixture
ASI-711	NPN	500 Ohm T-Attenuator
ASI-777	822-1429-001	Test Set for HF-9000 System (TE-9210)

Radio Set Test Harness

ASI-207-2

OEM Equivalent: Rockwell Collins MN: 678P-5 PN: 622-0304-001 Manual: 523-0764501 Manual Figure: 1	UUT: 490S-1
	Size: H: 10.50" W: 19.00" D: 10.00" Pwr: 115 VAC 400 Hz 3 Phase / 28 VDC

Description:
The ASI-207-2 is part of the ASI-207 Test Bench Harness which provides capability to test the 490S-1 Antenna Coupler at full rated power levels and permits hot mockup operation of the entire coupler system. Testing of the 490S-1 requires the use of a known good HF Control (714E-2/3/6) and HF Transceiver (618T-X or 628T-X). If the 628T-X is used then a 999W-X Adapter is required to interface it to the ASI-207-2 (W3). The ASI-207 may also be used in conjunction with the ASI-700-4 to test the 490S-1.

Refer to the 490S-1 manual for more detailed test set up information.

Equipment Supplied:		
<u>ASI MN</u>	<u>OEM PN</u>	<u>Description</u>
ASI-20-7A	617-9756-001	Cable: ASI-207-2 to 490S-1 (W1)
ASI-20-7B	617-9758-001	Cable: ASI-207-2 to 490S-1 (W2)
ASI-20-7C	617-9755-001	Cable: ASI-207-2 to 618T-X (W3)
ASI-20-7D	618-7711-001	Cable: 618T-X to Wattmeter (W4)
ASI-20-7E	618-7712-001	Cable: 490S-1 to Wattmeter (W5)
ASI-20-7F	617-9743-001	Cable: ASI-207-2 to Dc Power Supply
ASI-20-7G	747-8979-001	Cable: ASI-207-2 to AC Power Supply

Optional Equipment:		
<u>ASI MN</u>	<u>OEM PN</u>	<u>Description</u>
ASI-207	622-0158-001	Test Bench Harness (477W-7)

RF High Voltage Test Fixture		ASI-207-3	
OEM Equivalent: Rockwell Collins MN: NMN PN: NPN Manual: 523-0810646 Manual Figure: Table 9001	UUT: CPL-920D (822-0897-004 / -020) Size: H: 7.50" W: 5.25" D: 22.50" Pwr: From UUT	Equipment Supplied: <u>ASI MN</u> <u>OEM PN</u> <u>Description</u>	
Description: The ASI-207-3 RF High Voltage Test Fixture works in conjunction with a Dummy Antenna Shunt (172H-18/-18A) and associated bench equipment to test the Collins CPL-920D HF Antenna Couplers with enhanced lighting protection (-004 /-040). The ASI-207-3 must be calibrated annually with the same Dummy Antenna Shunt (172H-18/18A) that will be utilized during testing of the CPL-920D. It is recommended that this calibration be done by Rockwell Collins or Avionics Specialist, Inc.		Optional Equipment: <u>ASI MN</u> <u>OEM PN</u> <u>Description</u> ASI-207-1 622-0180-001 Dummy Antenna Shunt (172H-18) ASI-329-3 622-7148-001 Dummy Antenna Shunt (172H-18A) ASI-700-4 NPN HF/VHF Discrete Function Interface Unit ASI-70-04C NPN ARINC 753 HFDL Interface Panel ASI-711 NPN 500 Ohm T-Attenuator	
Control Card Test Set		ASI-207-4	
OEM Equivalent: Rockwell Collins MN: 967R-2 PN: 822-1176-001 Manual: 523-0810646 Manual Figure: Table 9001	UUT: CPL-920D Size: H: 7.00" W: 16.00" D: 17.00" Pwr: 115 VAC 60 Hz	Equipment Supplied: <u>ASI MN</u> <u>OEM PN</u> <u>Description</u> ASI-20-74A 988-5561-001 Cable: P4 / 40 Positions (W1) ASI-20-74B 988-5562-001 Cable: P1 / 40 Positions (W2) ASI-20-74C 988-5563-001 Cable: P2 / 26 Positions (W3) ASI-20-74D 988-5564-001 Cable: P3 / 26 Positions (W4) ASI-20-74E 988-5565-001 Cable: R82 / Test Clip (W5) ASI-20-74F 988-5566-001 Cable: J2 / 34 Positions (W14) ASI-20-74G2 988-5567-002 Cable: J4 / 26 Positions (W15) ASI-20-74H 988-5568-001 Cable: J1 / 50 Positions (W16) ASI-20-74J 988-5569-001 Cable: J3 / 24 Positions (W9)	
Description: The ASI-207-4 Control Card Test Set works in conjunction with a RS232 Computer Terminal (HP700/70 or equivalent) and associated bench equipment to test the Rockwell Collins CPL-920D HF Antenna Coupler Control Card (A4). The Control Software (091-1550-XXX) required for testing the LRU is internally programmed in the ASI-207-4.		Optional Equipment: <u>ASI MN</u> <u>OEM PN</u> <u>Description</u> ASI-20-74N NPN Special Test Connector for Manual Self Tests	
Power Supply Test Set		ASI-207-5	
OEM Equivalent: Rockwell Collins MN: TE1 PN: 752-8896-001 Manual: 523-0810646 Manual Figure: 9004	UUT: CPL-920D Size: H: 3.00" W: 12.00" D: 9.00" Pwr: 115 VAC 400 Hz	Equipment Supplied: <u>ASI MN</u> <u>OEM PN</u> <u>Description</u> ASI-20-75A NPN Cable: W1 ASI-20-75B NPN Cable: W2	
Description: The ASI-207-4 Control Card Test Set works in conjunction with associated bench equipment to test the Rockwell Collins CPL-920D Power Supply.		Optional Equipment: <u>ASI MN</u> <u>OEM PN</u> <u>Description</u>	
HFDL MIMS Discriminator Test Fixture		ASI-207-6	
OEM Equivalent: Rockwell Collins MN: TE2 PN: 989-2159-001 Manual: 523-0810646 Manual Figure: 9005	UUT: CPL-920D Size: H: 3.00" W: 12.00" D: 8.00" Pwr: 115 VAC 60 Hz	Equipment Supplied: <u>ASI MN</u> <u>OEM PN</u> <u>Description</u> ASI-20-76A NPN Cable: Ribbon (W1) ASI-20-76B NPN Cable: Test Pin (W2) ASI-20-76C1 989-2159-006 Test Cover, Top ASI-20-76C2 989-2159-007 Test Cover, Test Coil Cover ASI-20-76C3 989-2159-008 Test Cover, Bottom ASI-20-76D1 989-2159-011 SMB Plug Assy, .515" (Qty 2) ASI-20-76D2 989-2159-012 SMB Plug Assy, .559" (Qty 2) ASI-20-76E 989-2159-015 Plug Assy, Right Angle (Qty 2)	
Description: The ASI-207-6 HFDL MIMS Discriminator Test Fixture works in conjunction with other bench equipment to test the Rockwell Collins CPL-920D MIMS/Sensor Circuit Card (A3). The Software (8914-0310510-012) required for testing the LRU is internally programmed in the ASI-207-6.		Optional Equipment: <u>ASI MN</u> <u>OEM PN</u> <u>Description</u> ASI-207-10 989-2146-001 90 Degree Phase Shift Network ASI-207-11 989-2146-002 0 Degree Power Divider	
RF Network Test Fixture		ASI-207-7	
OEM Equivalent: Rockwell Collins MN: TE3 PN: 989-2167-001 Manual: 523-0810646 Manual Figure: 9006	UUT: CPL-920D Size: H: 2.00" W: 9.00" D: 7.00" Pwr: 28 VDC	Equipment Supplied: <u>ASI MN</u> <u>OEM PN</u> <u>Description</u> ASI-20-77A NPN Cable: Test Clip (W1)	
Description: The ASI-207-7 RF Network Test Fixture works in conjunction with the RF Holding Fixture (ASI-207-8) and the Calibration Fixture (ASI-207-9) to test the Rockwell Collins CPL-920D RF Network Assy (A2).		Optional Equipment: <u>ASI MN</u> <u>OEM PN</u> <u>Description</u> ASI-207-8 989-2168-001 RF Network Holding Fixture (TE4) ASI-207-9 989-2169-001 Calibration Fixture (TE5)	

RF Network Holding Fixture		ASI-207-8												
OEM Equivalent: Rockwell Collins MN: TE4 PN: 989-2168-001 Manual: 523-0810646 Manual Figure: 9007	UUT: CPL-920D Size: H: 5.00" W: 14.50" D: 8.00" Pwr: N/A	Equipment Supplied: <table border="1"> <thead> <tr> <th>ASI MN</th> <th>OEM PN</th> <th>Description</th> </tr> </thead> <tbody> <tr> <td>ASI-20-78A</td> <td>989-2168-009</td> <td>Cable, RF</td> </tr> <tr> <td>ASI-20-78B</td> <td>989-2168-010</td> <td>Cable, Test Clip</td> </tr> </tbody> </table>	ASI MN	OEM PN	Description	ASI-20-78A	989-2168-009	Cable, RF	ASI-20-78B	989-2168-010	Cable, Test Clip			
ASI MN	OEM PN	Description												
ASI-20-78A	989-2168-009	Cable, RF												
ASI-20-78B	989-2168-010	Cable, Test Clip												
Description: The ASI-207-8 RF Network Holding Fixture safely holds the RF Network Assy during bench testing with the RF Network Test Fixture (ASI-207-7).		Optional Equipment: <table border="1"> <thead> <tr> <th>ASI MN</th> <th>OEM PN</th> <th>Description</th> </tr> </thead> <tbody> <tr> <td>ASI-207-7</td> <td>989-2167-001</td> <td>RF Network Test Fixture (TE3)</td> </tr> <tr> <td>ASI-207-9</td> <td>989-2169-001</td> <td>Calibration Fixture (TE5)</td> </tr> </tbody> </table>	ASI MN	OEM PN	Description	ASI-207-7	989-2167-001	RF Network Test Fixture (TE3)	ASI-207-9	989-2169-001	Calibration Fixture (TE5)			
ASI MN	OEM PN	Description												
ASI-207-7	989-2167-001	RF Network Test Fixture (TE3)												
ASI-207-9	989-2169-001	Calibration Fixture (TE5)												
RF Network Calibration Fixture		ASI-207-9												
OEM Equivalent: Rockwell Collins MN: TE5 PN: 989-2169-001 Manual: 523-0810646 Manual Figure: 9008	UUT: CPL-920D Size: H: 2.00" W: 2.50" D: 3.00" Pwr: N/A	Equipment Supplied: <table border="1"> <thead> <tr> <th>ASI MN</th> <th>OEM PN</th> <th>Description</th> </tr> </thead> <tbody> </tbody> </table>	ASI MN	OEM PN	Description									
ASI MN	OEM PN	Description												
Description: The ASI-207-9 RF Network Calibration Fixture works in conjunction with the RF Network Test Fixture (ASI-207-7) and the RF Holding Fixture (ASI-207-8) to test the Rockwell Collins CPL-920D RF Network Assy (A2).		Optional Equipment: <table border="1"> <thead> <tr> <th>ASI MN</th> <th>OEM PN</th> <th>Description</th> </tr> </thead> <tbody> <tr> <td>ASI-207-7</td> <td>989-2167-001</td> <td>RF Network Test Fixture (TE3)</td> </tr> <tr> <td>ASI-207-8</td> <td>989-2168-001</td> <td>RF Network Holding Fixture (TE4)</td> </tr> </tbody> </table>	ASI MN	OEM PN	Description	ASI-207-7	989-2167-001	RF Network Test Fixture (TE3)	ASI-207-8	989-2168-001	RF Network Holding Fixture (TE4)			
ASI MN	OEM PN	Description												
ASI-207-7	989-2167-001	RF Network Test Fixture (TE3)												
ASI-207-8	989-2168-001	RF Network Holding Fixture (TE4)												
90 Degree Phase Shift Network		ASI-207-10												
OEM Equivalent: Rockwell Collins MN: NMN PN: 989-2146-001 Manual: 523-0810646 Manual Figure: 9009	UUT: CPL-920D Size: H: 0.75" W: 5.50" D: 2.50" Pwr: N/A	Equipment Supplied: <table border="1"> <thead> <tr> <th>ASI MN</th> <th>OEM PN</th> <th>Description</th> </tr> </thead> <tbody> </tbody> </table>	ASI MN	OEM PN	Description									
ASI MN	OEM PN	Description												
Description: The ASI-207-10 90 Degree Phase Shift Network works in conjunction with the MIMS Test Fixture (ASI-207-6), two RF cables (ASI-207-12) and various other bench equipment to test the Rockwell Collins CPL-920D MIMS/Sensor Circuit Card (A3).		Optional Equipment: <table border="1"> <thead> <tr> <th>ASI MN</th> <th>OEM PN</th> <th>Description</th> </tr> </thead> <tbody> <tr> <td>ASI-207-6</td> <td>989-2159-001</td> <td>MIMS Discriminator Fixture (TE2)</td> </tr> <tr> <td>ASI-207-11</td> <td>989-2146-002</td> <td>0 Degree Power Divider</td> </tr> <tr> <td>ASI-207-12</td> <td>989-2146-007</td> <td>RF Test Cable (W3-W4) / Qty 2 Required</td> </tr> </tbody> </table>	ASI MN	OEM PN	Description	ASI-207-6	989-2159-001	MIMS Discriminator Fixture (TE2)	ASI-207-11	989-2146-002	0 Degree Power Divider	ASI-207-12	989-2146-007	RF Test Cable (W3-W4) / Qty 2 Required
ASI MN	OEM PN	Description												
ASI-207-6	989-2159-001	MIMS Discriminator Fixture (TE2)												
ASI-207-11	989-2146-002	0 Degree Power Divider												
ASI-207-12	989-2146-007	RF Test Cable (W3-W4) / Qty 2 Required												
0 Degree Power Divider		ASI-207-11												
OEM Equivalent: Rockwell Collins MN: NMN PN: 989-2146-002 Manual: 523-0810646 Manual Figure: 9009	UUT: CPL-920D Size: H: 0.75" W: 4.50" D: 2.50" Pwr: N/A	Equipment Supplied: <table border="1"> <thead> <tr> <th>ASI MN</th> <th>OEM PN</th> <th>Description</th> </tr> </thead> <tbody> </tbody> </table>	ASI MN	OEM PN	Description									
ASI MN	OEM PN	Description												
Description: The ASI-207-11 0 Degree Power Divider works in conjunction with the MIMS Test Fixture (ASI-207-6), two RF cables (ASI-207-12) and various other bench equipment to test the Rockwell Collins CPL-920D MIMS/Sensor Circuit Card (A3).		Optional Equipment: <table border="1"> <thead> <tr> <th>ASI MN</th> <th>OEM PN</th> <th>Description</th> </tr> </thead> <tbody> <tr> <td>ASI-207-6</td> <td>989-2159-001</td> <td>MIMS Discriminator Fixture (TE2)</td> </tr> <tr> <td>ASI-207-10</td> <td>989-2146-001</td> <td>90 Degree Phase Shift Network</td> </tr> <tr> <td>ASI-207-12</td> <td>989-2146-007</td> <td>RF Test Cable (W3-W4) / Qty 2 Required</td> </tr> </tbody> </table>	ASI MN	OEM PN	Description	ASI-207-6	989-2159-001	MIMS Discriminator Fixture (TE2)	ASI-207-10	989-2146-001	90 Degree Phase Shift Network	ASI-207-12	989-2146-007	RF Test Cable (W3-W4) / Qty 2 Required
ASI MN	OEM PN	Description												
ASI-207-6	989-2159-001	MIMS Discriminator Fixture (TE2)												
ASI-207-10	989-2146-001	90 Degree Phase Shift Network												
ASI-207-12	989-2146-007	RF Test Cable (W3-W4) / Qty 2 Required												
RF Test Cable		ASI-207-12												
OEM Equivalent: Rockwell Collins MN: NMN PN: 989-2146-007 Manual: 523-0810646 Manual Figure: 9009	UUT: CPL-920D Size: L: 18.00" Pwr: N/A	Equipment Supplied: <table border="1"> <thead> <tr> <th>ASI MN</th> <th>OEM PN</th> <th>Description</th> </tr> </thead> <tbody> </tbody> </table>	ASI MN	OEM PN	Description									
ASI MN	OEM PN	Description												
Description: The ASI-207-12 RF Test Cable is a special coax that interfaces the 90 Degree Phase Shift Network (ASI-207-10) or the 0 Degree Power Divider (ASI-207-11) to the CPL-920D as required during testing. 2 of these cables are required during testing.		Optional Equipment: <table border="1"> <thead> <tr> <th>ASI MN</th> <th>OEM PN</th> <th>Description</th> </tr> </thead> <tbody> <tr> <td>ASI-207-6</td> <td>989-2159-001</td> <td>MIMS Discriminator Fixture (TE2)</td> </tr> <tr> <td>ASI-207-10</td> <td>989-2146-001</td> <td>90 Degree Phase Shift Network</td> </tr> <tr> <td>ASI-207-11</td> <td>989-2146-002</td> <td>0 Degree Power Divider</td> </tr> </tbody> </table>	ASI MN	OEM PN	Description	ASI-207-6	989-2159-001	MIMS Discriminator Fixture (TE2)	ASI-207-10	989-2146-001	90 Degree Phase Shift Network	ASI-207-11	989-2146-002	0 Degree Power Divider
ASI MN	OEM PN	Description												
ASI-207-6	989-2159-001	MIMS Discriminator Fixture (TE2)												
ASI-207-10	989-2146-001	90 Degree Phase Shift Network												
ASI-207-11	989-2146-002	0 Degree Power Divider												
Coax Test Adapter		ASI-207-13												
OEM Equivalent: Rockwell Collins MN: NMN PN: 652-2443-001 Manual: 523-0810646 Manual Figure: 9010	UUT: CPL-920D Size: H: 6.00" W: 6.00" D: 2.50" Pwr: N/A	Equipment Supplied: <table border="1"> <thead> <tr> <th>ASI MN</th> <th>OEM PN</th> <th>Description</th> </tr> </thead> <tbody> </tbody> </table>	ASI MN	OEM PN	Description									
ASI MN	OEM PN	Description												
Description: The ASI-207-13 Coax Test Adapter mates with the rear connector of the Rockwell Collins CPL-920D as required for testing purposes.		Optional Equipment: <table border="1"> <thead> <tr> <th>ASI MN</th> <th>OEM PN</th> <th>Description</th> </tr> </thead> <tbody> <tr> <td>ASI-207-1</td> <td>622-0180-001</td> <td>Antenna Simulator (172H-18)</td> </tr> <tr> <td>ASI-700-4</td> <td>NPN</td> <td>HF/VHF DFJU Test Panel</td> </tr> <tr> <td>ASI-70-04C</td> <td>NPN</td> <td>ARINC-754 HFDL Interface Cable</td> </tr> </tbody> </table>	ASI MN	OEM PN	Description	ASI-207-1	622-0180-001	Antenna Simulator (172H-18)	ASI-700-4	NPN	HF/VHF DFJU Test Panel	ASI-70-04C	NPN	ARINC-754 HFDL Interface Cable
ASI MN	OEM PN	Description												
ASI-207-1	622-0180-001	Antenna Simulator (172H-18)												
ASI-700-4	NPN	HF/VHF DFJU Test Panel												
ASI-70-04C	NPN	ARINC-754 HFDL Interface Cable												

Antenna Coupler Test Set**ASI-208**

Description of Operation:
The ASI-208 provides testing of the Collins 490S-1 Antenna Coupler.

Equivalent OEM: Collins
Equivalent MN: 980H-5
Equivalent PN: 777-1526-001

Units Tested:
490S-1

The ASI-208 includes the ASI-208-1/-2/-3/-4/-5 mounted in a rugged case.

Equipment Supplied:

ASI-208-1	Discriminator Test Panel (878L-19D)
ASI-208-2	Power Panel (617-9736-001)
ASI-208-3	Servo-Power Supply Test Panel (878L-39)
ASI-208-4	Tuner Chassis Test Panel (878L-40)
ASI-208-5	Logic Card Test Set (878L-41)

The ASI-208-1 /-2 /-3 /-4 may be purchased together (without the ASI-208-5) under the model number ASI-208-6 (EQ CMN 973K-1 / PN 622-0337-001)

Discriminator Test Panel**ASI-208-1**

Description of Operation:
The ASI-208-1 permits testing and alignment of the discriminator module contained in the 490S-1 Antenna Coupler. The discriminator error signals are monitored by a meter on the front panel of the ASI-339-1

Equivalent OEM: Collins
Equivalent MN: 878L-19D
Equivalent PN: 622-0226-001

Units Tested:
490S-1 Discriminator Module

Equipment Supplied:

ASI-20-81A	Module Extender Adapter (617-9781-001)
ASI-20-81B	W1 RF Cable (617-9760-001)

Equipment Specifications:

Height: 5.25" Width: 19.00" Depth: 7.125"

Power Panel**ASI-208-2**

Description of Operation:
The ASI-208-2 Power Panel controls AC power input into the ASI-208. One power cable is supplied with the panel.

Equivalent OEM: Collins
Equivalent MN:
Equivalent PN: 617-9736-001

Units Tested:

Equipment Specifications:

Height: 1.75" Width: 19.00" Depth: 2.25"

Equipment Supplied:

ASI-20-82A	Power Cable (608-9941-001)
------------	----------------------------

Servo-Power Supply Test Panel**ASI-208-3**

Description of Operation:
The ASI-208-3 permits testing of the 490S-1 servo amplifier and power supply circuit cards.

Equivalent OEM: Collins
Equivalent MN: 878L-39
Equivalent PN: 622-0227-001

Units Tested:
490S-1 Servo Amp Card
490S-1 Power Supply Card

Equipment Supplied:

ASI-20-83A	W1 Cable (617-9770-001)
ASI-20-82A	Power Cable (608-9941-001)

Equipment Specifications:

Height: 5.25" Width: 19.00" Depth: 7.25"

Tuner-Chassis Test Panel**ASI-208-4**

Description of Operation:
The ASI-208-4 is used to check the 490S-1 chassis wiring continuity and tuner module operation without applied RF voltage.

Equivalent OEM: Collins
Equivalent MN: 878L-40
Equivalent PN: 622-0228-001

Units Tested:
490S-1 Tuner Module
490S-1 Chassis Wiring

Equipment Supplied:

ASI-20-84A	W1 Cable (609-9433-001)
ASI-20-84B	W2 Cable (609-9459-001)
ASI-20-84C	W3 Cable (609-9487-001)
ASI-20-82A	Power Cable (608-9941-001)

Equipment Specifications:

Height: 5.25" Width: 19.00" Depth: 7.25"

Logic Card Test Set**ASI-208-5**

Description of Operation:
The ASI-208-5 is used to perform a complete test of the 490S-1 interface logic and control logic cards. The cards under test connect directly to the test set.

Equivalent OEM: Collins
Equivalent MN: 878L-41
Equivalent PN: 622-0229-001

Units Tested:
490S-1 Interface Logic Card
490S-1 Control Logic Card

Equipment Supplied:

ASI-20-85A	2A1 Program Board (609-9410-001)
ASI-20-85B	2A2 Program Board (609-9410-002)
ASI-20-85C	2A3 Program Board (609-9411-001)
ASI-20-85D	2A4 Program Board (609-9411-002)
ASI-20-85E	2W1 Cable (608-9942-001)
ASI-20-85F	2W2 Cable (608-9862-001)

Equipment Specifications:

Height: 9.75" Width: 21.75" Depth: 20.125"

REV 3
3-1-98

Radio Set Test Harness		ASI-209-1A																																																																																						
OEM Equivalent: Rockwell Collins MN: 678P-1A PN: 547-3914-000 Manual: 523-0758156 Manual Figure: 1-1	UUT: 618T-1/1B/2/2B/3/3B 628T-1/1B/2/2A/3/3A Size: H: 9.50" W: 8.50" D: 16.00" Pwr: 115 VAC 400 Hz / 28 VDC	Description: The ASI-209-1A Radio Set Test Harness tests the 618T-X and 628T-X HF Receiver-Transmitters. The Radio Set Test Harness controls power, RF and audio signals and also facilitates interconnection of the HF system components. The RF wattmeter functions that are required for measuring transmitter power output is incorporated in the Test Harness. 628T-1/2/3 testing requires use of the additional test adapters and breakout boxes shown in the optional equipment section.																																																																																						
Equipment Supplied:		Optional Equipment:																																																																																						
<table border="1"> <thead> <tr> <th>ASI MN</th> <th>OEM PN</th> <th>Description</th> </tr> </thead> <tbody> <tr><td>ASI-8292-006</td><td>548-8292-006</td><td>Radio Test Set</td></tr> <tr><td>ASI-20-9A</td><td>548-8002-004</td><td>Cable W3, ASI-209 to 618T-X</td></tr> <tr><td>ASI-20-9B</td><td>548-8003-004</td><td>Cable W4, ASI-209 to 516H-1</td></tr> <tr><td>ASI-20-9C</td><td>548-8023-003</td><td>Cable W5, ASI-209 DC PWR</td></tr> <tr><td>ASI-20-9D</td><td>548-8025-003</td><td>Cable W6, ASI-209 AC PWR</td></tr> <tr><td>ASI-20-9E</td><td>548-8029-004</td><td>Cable W7, ASI-209 to 714E-1/-2</td></tr> <tr><td>ASI-20-9F</td><td>548-8284-004</td><td>Cable W8, ASI-209 to 714E-3/-6</td></tr> <tr><td>ASI-20-9G</td><td>548-8285-004</td><td>Cable W9, ASI-209 to 309A-1</td></tr> <tr><td>ASI-20-9H</td><td>548-8286-004</td><td>Cable, W10, ASI-209 to 309A-2D</td></tr> <tr><td>ASI-20-9J</td><td>548-8287-004</td><td>Cable W11, ASI-209 to 180L-2/-3</td></tr> <tr><td>ASI-20-9K</td><td>549-4334-002</td><td>Cable W12, RF</td></tr> <tr><td>ASI-20-9L</td><td>554-2915-004</td><td>Cable W13, ASI-209 to CU-351</td></tr> <tr><td>ASI-20-9M</td><td>757-1377-001</td><td>Cable W18, ASI-209 to 490T-1/-1A</td></tr> <tr><td>UG-201A/U</td><td>357-9291-000</td><td>RF Adapter (Qty 2)</td></tr> </tbody> </table>	ASI MN	OEM PN	Description	ASI-8292-006	548-8292-006	Radio Test Set	ASI-20-9A	548-8002-004	Cable W3, ASI-209 to 618T-X	ASI-20-9B	548-8003-004	Cable W4, ASI-209 to 516H-1	ASI-20-9C	548-8023-003	Cable W5, ASI-209 DC PWR	ASI-20-9D	548-8025-003	Cable W6, ASI-209 AC PWR	ASI-20-9E	548-8029-004	Cable W7, ASI-209 to 714E-1/-2	ASI-20-9F	548-8284-004	Cable W8, ASI-209 to 714E-3/-6	ASI-20-9G	548-8285-004	Cable W9, ASI-209 to 309A-1	ASI-20-9H	548-8286-004	Cable, W10, ASI-209 to 309A-2D	ASI-20-9J	548-8287-004	Cable W11, ASI-209 to 180L-2/-3	ASI-20-9K	549-4334-002	Cable W12, RF	ASI-20-9L	554-2915-004	Cable W13, ASI-209 to CU-351	ASI-20-9M	757-1377-001	Cable W18, ASI-209 to 490T-1/-1A	UG-201A/U	357-9291-000	RF Adapter (Qty 2)	<table border="1"> <thead> <tr> <th>ASI MN</th> <th>OEM PN</th> <th>Description</th> </tr> </thead> <tbody> <tr><td>ASI-70-04P</td><td></td><td>A5 Alignment Fixture for 628T-2/2A / HFS-700</td></tr> <tr><td>ASI-101D</td><td></td><td>Digital Signal Generator / Audio Oscillator</td></tr> <tr><td>ASI-209-6</td><td>635-6382-001</td><td>Test Adapter for 628T-1/1B</td></tr> <tr><td>ASI-209-7</td><td></td><td>Breakout Box for 628T-1/1B</td></tr> <tr><td>ASI-209-8</td><td>642-6964-011</td><td>Test Adapter for 628T-2/2A</td></tr> <tr><td>ASI-209-9</td><td>642-6964-010</td><td>Breakout Box for 628T-2/2A</td></tr> <tr><td>ASI-209-10</td><td>642-7952-001</td><td>Test Adapter for 628T-3/3A</td></tr> <tr><td>ASI-209-11</td><td></td><td>Breakout Box for 628T-3/3A</td></tr> <tr><td>ASI-700-4</td><td></td><td>VHF/HF DFIU</td></tr> <tr><td>ASI-711</td><td></td><td>500 Ohm T-Attenuator</td></tr> <tr><td>ASI-712</td><td></td><td>RF Injection Probe</td></tr> <tr><td>ASI-6964-628T</td><td>642-6964-001</td><td>628T-2/2A Test Kit (ASI-209-8 and ASI-209-9)</td></tr> </tbody> </table>	ASI MN	OEM PN	Description	ASI-70-04P		A5 Alignment Fixture for 628T-2/2A / HFS-700	ASI-101D		Digital Signal Generator / Audio Oscillator	ASI-209-6	635-6382-001	Test Adapter for 628T-1/1B	ASI-209-7		Breakout Box for 628T-1/1B	ASI-209-8	642-6964-011	Test Adapter for 628T-2/2A	ASI-209-9	642-6964-010	Breakout Box for 628T-2/2A	ASI-209-10	642-7952-001	Test Adapter for 628T-3/3A	ASI-209-11		Breakout Box for 628T-3/3A	ASI-700-4		VHF/HF DFIU	ASI-711		500 Ohm T-Attenuator	ASI-712		RF Injection Probe	ASI-6964-628T	642-6964-001	628T-2/2A Test Kit (ASI-209-8 and ASI-209-9)			
ASI MN	OEM PN	Description																																																																																						
ASI-8292-006	548-8292-006	Radio Test Set																																																																																						
ASI-20-9A	548-8002-004	Cable W3, ASI-209 to 618T-X																																																																																						
ASI-20-9B	548-8003-004	Cable W4, ASI-209 to 516H-1																																																																																						
ASI-20-9C	548-8023-003	Cable W5, ASI-209 DC PWR																																																																																						
ASI-20-9D	548-8025-003	Cable W6, ASI-209 AC PWR																																																																																						
ASI-20-9E	548-8029-004	Cable W7, ASI-209 to 714E-1/-2																																																																																						
ASI-20-9F	548-8284-004	Cable W8, ASI-209 to 714E-3/-6																																																																																						
ASI-20-9G	548-8285-004	Cable W9, ASI-209 to 309A-1																																																																																						
ASI-20-9H	548-8286-004	Cable, W10, ASI-209 to 309A-2D																																																																																						
ASI-20-9J	548-8287-004	Cable W11, ASI-209 to 180L-2/-3																																																																																						
ASI-20-9K	549-4334-002	Cable W12, RF																																																																																						
ASI-20-9L	554-2915-004	Cable W13, ASI-209 to CU-351																																																																																						
ASI-20-9M	757-1377-001	Cable W18, ASI-209 to 490T-1/-1A																																																																																						
UG-201A/U	357-9291-000	RF Adapter (Qty 2)																																																																																						
ASI MN	OEM PN	Description																																																																																						
ASI-70-04P		A5 Alignment Fixture for 628T-2/2A / HFS-700																																																																																						
ASI-101D		Digital Signal Generator / Audio Oscillator																																																																																						
ASI-209-6	635-6382-001	Test Adapter for 628T-1/1B																																																																																						
ASI-209-7		Breakout Box for 628T-1/1B																																																																																						
ASI-209-8	642-6964-011	Test Adapter for 628T-2/2A																																																																																						
ASI-209-9	642-6964-010	Breakout Box for 628T-2/2A																																																																																						
ASI-209-10	642-7952-001	Test Adapter for 628T-3/3A																																																																																						
ASI-209-11		Breakout Box for 628T-3/3A																																																																																						
ASI-700-4		VHF/HF DFIU																																																																																						
ASI-711		500 Ohm T-Attenuator																																																																																						
ASI-712		RF Injection Probe																																																																																						
ASI-6964-628T	642-6964-001	628T-2/2A Test Kit (ASI-209-8 and ASI-209-9)																																																																																						
Radio Set Test Harness		ASI-209-1B																																																																																						
OEM Equivalent: Rockwell Collins MN: 678P-1B PN: 777-1861-001 Manual: 523-0758156 Manual Figure: 1-1	UUT: 618T-1/1B/2/2B/3/3B 628T-1/1B/2/2A/3/3A Size: H: 9.50" W: 8.50" D: 16.00" Pwr: 115 VAC 400 Hz / 28 VDC	Description: The ASI-209-1B (678P-1B) is identical in all aspects to the ASI-209-1A (678P-1A). The only difference between the two units is the model number and part number printed on the identification tag.																																																																																						
Radio Set Test Harness		ASI-209-1C																																																																																						
OEM Equivalent: Rockwell Collins MN: 678P-1C PN: 622-4211-001 Manual: 523-0758156 Manual Figure: 1-1	UUT: 618T-1/1B/2/2B/3/3B 628T-1/1B/2/2A/3/3A Size: H: 9.50" W: 8.50" D: 16.00" Pwr: 115 VAC 400 Hz / 28 VDC	Description: The ASI-209-1C (678P-1C) is similar to the ASI-209-1A (678P-1A). The main difference is that the ASI-209-1C only includes the 628T-1/1B Test Adapter (ASI-209-6) and three cables (ASI-20-9E / ASI-20-9F / ASI-20-9K). Two UG-201A/U RF Adapters are also included.																																																																																						
Radio Set Test Harness		ASI-209-2A																																																																																						
OEM Equivalent: Rockwell Collins MN: 678P-2A PN: 522-3400-005 Manual: 523-0758156 Manual Figure: 1-1	UUT: 618T-1/1B/2/2B/3/3B 628T-1/1B/2/2A/3/3A Size: H: 9.50" W: 8.50" D: 16.00" Pwr: 115 VAC 400 Hz / 28 VDC	Description: The ASI-209-2A (678P-2A) is identical in all aspects to the ASI-209-1A (678P-1A). The only differences between the two units is the model number / part number printed on the identification tag and the ASI-209-2A (678P-2A) includes a transit/storage case (ASI-0257-001 / 021-0257-000).																																																																																						
Radio Set Test Harness		ASI-209-2B																																																																																						
OEM Equivalent: Rockwell Collins MN: 678P-2B / AN/URM-157A PN: 792-6229-001 Manual: 523-0758156 Manual Figure: 1-1	UUT: 618T-1/1B/2/2B/3/3B 628T-1/1B/2/2A/3/3A Size: H: 9.50" W: 8.50" D: 16.00" Pwr: 115 VAC 400 Hz / 28 VDC	Description: The ASI-209-1A Radio Set Test Harness tests the 618T-X and 628T-X HF Receiver-Transmitters. The Radio Set Test Harness controls power, RF and audio signals and also facilitates interconnection of the HF system components. The RF wattmeter functions that are required for measuring transmitter power output is incorporated in the Test Harness. 628T-1/2/3 testing requires use of the additional test adapters and breakout boxes shown in the optional equipment section.																																																																																						
Equipment Supplied:		Optional Equipment:																																																																																						
<table border="1"> <thead> <tr> <th>ASI MN</th> <th>OEM PN</th> <th>Description</th> </tr> </thead> <tbody> <tr><td>ASI-8560-003</td><td>757-8560-003</td><td>Radio Test Set</td></tr> <tr><td>ASI-20-9A1</td><td>548-8002-005</td><td>Cable W3, ASI-209 to 618T-X</td></tr> <tr><td>ASI-20-9B1</td><td>548-8003-005</td><td>Cable W4, ASI-209 to 516H-1</td></tr> <tr><td>ASI-20-9C1</td><td>548-8023-004</td><td>Cable W5, ASI-209 DC PWR</td></tr> <tr><td>ASI-20-9D1</td><td>548-8025-004</td><td>Cable W6, ASI-209 AC PWR</td></tr> <tr><td>ASI-20-9E1</td><td>548-8029-005</td><td>Cable W7, ASI-209 to 714E-1/-2</td></tr> <tr><td>ASI-20-9F1</td><td>548-8284-005</td><td>Cable W8, ASI-209 to 714E-3/-6</td></tr> <tr><td>ASI-20-9G1</td><td>548-8285-005</td><td>Cable W9, ASI-209 to 309A-1</td></tr> <tr><td>ASI-20-9H1</td><td>548-8286-005</td><td>Cable, W10, ASI-209 to 309A-2D</td></tr> <tr><td>ASI-20-9J1</td><td>548-8287-005</td><td>Cable W11, ASI-209 to 180L-2/-3</td></tr> <tr><td>ASI-20-9K1</td><td>549-4334-003</td><td>Cable W12, RF</td></tr> <tr><td>ASI-20-9L1</td><td>554-2915-005</td><td>Cable W13, ASI-209 to CU-351</td></tr> <tr><td>ASI-20-9M1</td><td>757-1377-002</td><td>Cable W18, ASI-209 to 490T-1/-1A</td></tr> <tr><td>UG-201A/U</td><td>357-9291-000</td><td>RF Adapter (Qty 2)</td></tr> <tr><td>ASI-0257-000</td><td>021-0257-000</td><td>Transit / Storage Case</td></tr> </tbody> </table>	ASI MN	OEM PN	Description	ASI-8560-003	757-8560-003	Radio Test Set	ASI-20-9A1	548-8002-005	Cable W3, ASI-209 to 618T-X	ASI-20-9B1	548-8003-005	Cable W4, ASI-209 to 516H-1	ASI-20-9C1	548-8023-004	Cable W5, ASI-209 DC PWR	ASI-20-9D1	548-8025-004	Cable W6, ASI-209 AC PWR	ASI-20-9E1	548-8029-005	Cable W7, ASI-209 to 714E-1/-2	ASI-20-9F1	548-8284-005	Cable W8, ASI-209 to 714E-3/-6	ASI-20-9G1	548-8285-005	Cable W9, ASI-209 to 309A-1	ASI-20-9H1	548-8286-005	Cable, W10, ASI-209 to 309A-2D	ASI-20-9J1	548-8287-005	Cable W11, ASI-209 to 180L-2/-3	ASI-20-9K1	549-4334-003	Cable W12, RF	ASI-20-9L1	554-2915-005	Cable W13, ASI-209 to CU-351	ASI-20-9M1	757-1377-002	Cable W18, ASI-209 to 490T-1/-1A	UG-201A/U	357-9291-000	RF Adapter (Qty 2)	ASI-0257-000	021-0257-000	Transit / Storage Case	<table border="1"> <thead> <tr> <th>ASI MN</th> <th>OEM PN</th> <th>Description</th> </tr> </thead> <tbody> <tr><td>ASI-70-04P</td><td></td><td>A5 Alignment Fixture for 628T-2/2A / HFS-700</td></tr> <tr><td>ASI-101D</td><td></td><td>Digital Signal Generator / Audio Oscillator</td></tr> <tr><td>ASI-209-6</td><td>635-6382-001</td><td>Test Adapter for 628T-1/1B</td></tr> <tr><td>ASI-209-7</td><td></td><td>Breakout Box for 628T-1/1B</td></tr> <tr><td>ASI-209-8</td><td>642-6964-011</td><td>Test Adapter for 628T-2/2A</td></tr> <tr><td>ASI-209-9</td><td>642-6964-010</td><td>Breakout Box for 628T-2/2A</td></tr> <tr><td>ASI-209-10</td><td>642-7952-001</td><td>Test Adapter for 628T-3/3A</td></tr> <tr><td>ASI-209-11</td><td></td><td>Breakout Box for 628T-3/3A</td></tr> <tr><td>ASI-700-4</td><td></td><td>VHF/HF DFIU</td></tr> <tr><td>ASI-711</td><td></td><td>500 Ohm T-Attenuator</td></tr> <tr><td>ASI-712</td><td></td><td>RF Injection Probe</td></tr> <tr><td>ASI-6964-628T</td><td>642-6964-001</td><td>628T-2/2A Test Kit (ASI-209-8 and ASI-209-9)</td></tr> </tbody> </table>	ASI MN	OEM PN	Description	ASI-70-04P		A5 Alignment Fixture for 628T-2/2A / HFS-700	ASI-101D		Digital Signal Generator / Audio Oscillator	ASI-209-6	635-6382-001	Test Adapter for 628T-1/1B	ASI-209-7		Breakout Box for 628T-1/1B	ASI-209-8	642-6964-011	Test Adapter for 628T-2/2A	ASI-209-9	642-6964-010	Breakout Box for 628T-2/2A	ASI-209-10	642-7952-001	Test Adapter for 628T-3/3A	ASI-209-11		Breakout Box for 628T-3/3A	ASI-700-4		VHF/HF DFIU	ASI-711		500 Ohm T-Attenuator	ASI-712		RF Injection Probe	ASI-6964-628T	642-6964-001	628T-2/2A Test Kit (ASI-209-8 and ASI-209-9)
ASI MN	OEM PN	Description																																																																																						
ASI-8560-003	757-8560-003	Radio Test Set																																																																																						
ASI-20-9A1	548-8002-005	Cable W3, ASI-209 to 618T-X																																																																																						
ASI-20-9B1	548-8003-005	Cable W4, ASI-209 to 516H-1																																																																																						
ASI-20-9C1	548-8023-004	Cable W5, ASI-209 DC PWR																																																																																						
ASI-20-9D1	548-8025-004	Cable W6, ASI-209 AC PWR																																																																																						
ASI-20-9E1	548-8029-005	Cable W7, ASI-209 to 714E-1/-2																																																																																						
ASI-20-9F1	548-8284-005	Cable W8, ASI-209 to 714E-3/-6																																																																																						
ASI-20-9G1	548-8285-005	Cable W9, ASI-209 to 309A-1																																																																																						
ASI-20-9H1	548-8286-005	Cable, W10, ASI-209 to 309A-2D																																																																																						
ASI-20-9J1	548-8287-005	Cable W11, ASI-209 to 180L-2/-3																																																																																						
ASI-20-9K1	549-4334-003	Cable W12, RF																																																																																						
ASI-20-9L1	554-2915-005	Cable W13, ASI-209 to CU-351																																																																																						
ASI-20-9M1	757-1377-002	Cable W18, ASI-209 to 490T-1/-1A																																																																																						
UG-201A/U	357-9291-000	RF Adapter (Qty 2)																																																																																						
ASI-0257-000	021-0257-000	Transit / Storage Case																																																																																						
ASI MN	OEM PN	Description																																																																																						
ASI-70-04P		A5 Alignment Fixture for 628T-2/2A / HFS-700																																																																																						
ASI-101D		Digital Signal Generator / Audio Oscillator																																																																																						
ASI-209-6	635-6382-001	Test Adapter for 628T-1/1B																																																																																						
ASI-209-7		Breakout Box for 628T-1/1B																																																																																						
ASI-209-8	642-6964-011	Test Adapter for 628T-2/2A																																																																																						
ASI-209-9	642-6964-010	Breakout Box for 628T-2/2A																																																																																						
ASI-209-10	642-7952-001	Test Adapter for 628T-3/3A																																																																																						
ASI-209-11		Breakout Box for 628T-3/3A																																																																																						
ASI-700-4		VHF/HF DFIU																																																																																						
ASI-711		500 Ohm T-Attenuator																																																																																						
ASI-712		RF Injection Probe																																																																																						
ASI-6964-628T	642-6964-001	628T-2/2A Test Kit (ASI-209-8 and ASI-209-9)																																																																																						
Radio Set Test Harness		ASI-209-2C																																																																																						
OEM Equivalent: Rockwell Collins MN: 678P-2C PN: 522-3400-007 / -008 Manual: 523-0758156 Manual Figure: 1-1	UUT: 618T-1/1B/2/2B/3/3B 628T-1/1B/2/2A/3/3A Size: H: 9.50" W: 8.50" D: 16.00" Pwr: 115 VAC 400 Hz / 28 VDC	Description: The ASI-209-2C (678P-2C) has been replaced by the ASI-209-2A (678P-2A).																																																																																						
Radio Set Test Harness		ASI-209-2D																																																																																						
OEM Equivalent: Rockwell Collins MN: 678P-2D / AN/URM-157 PN: 522-3400-006 Manual: 523-0758156 Manual Figure: 1-1	UUT: 618T-1/1B/2/2B/3/3B 628T-1/1B/2/2A/3/3A Size: H: 9.50" W: 8.50" D: 16.00" Pwr: 115 VAC 400 Hz / 28 VDC	Description: The ASI-209-2D (678P-2D / AN/URM-157) is similar to the ASI-209-2B (678P-2B / AN/URM-157A). The main difference is that the ASI-209-2D (678P-2D / AN/URM-157) includes a Control (714E-3 / C-3940/ARC-94).																																																																																						

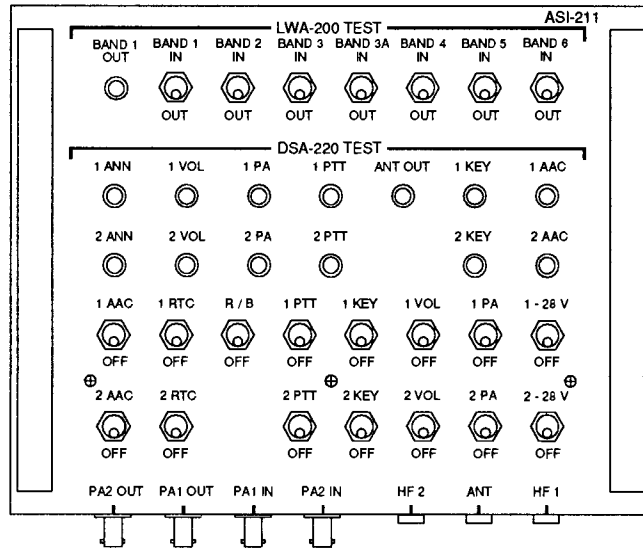

This unit is manufactured to replace the OEM model and/or part number listed below in form, fit, and function.

Equivalent OEM: Collins
 Equivalent MN:
 Equivalent PN:

Units Tested:
 DSA-220 Dual System Adapter
 LWA-200 Long Wire Adapter

Manual Figure: DSA-220, Fig. 5-1
 LWA-200, Fig. 5-1

Description of Operation:

The ASI-211 Dual System / Long Wire Adapter Test Set is a bi-functional piece of test equipment configured to facilitate testing and repair of the Collins DSA-220 Dual System Adapter and the LWA-200 Long Wire Adapter. All necessary switching, test indications, and signal inputs / outputs are provided on the ASI-211.

Specifications:

Height: 2.25" Width: 7.00" Depth: 5.50" Power: 28 VDC

Equipment Supplied:

ASI MN	Equivalent PN	Description
--------	---------------	-------------

Optional Equipment:

ASI MN	Equivalent PN	Description
--------	---------------	-------------

Torque Tester		ASI-212-1																									
OEM Equivalent: Rockwell Collins MN: 960M-1 PN: 622-0471-001 Manual: 523-0762690 / 523-0766552 Manual Figure: 1007 / 5-13	UUT: 334C-6/-6A/-6B/-6C/-6D SVO-80/-80A/-80B/-80C Size: H: 6.00" W: 46.00" D: 10.00" Pwr: None	Equipment Supplied:																									
Description: The ASI-212-1 Torque Tester is a precision balance-beam torque measuring device used in conjunction with the ASI-213-1 or ASI-213-2 for testing, troubleshooting, and overhaul of the Collins 334C-6() and SVO-80() Primary Servos. The Torque Tester consists of a mounting base, servo mounting base, calibrated balance beam, and test weights. See the ASI-213 catalog page for optional servo/servo mount tools and equipment.		<table border="0"> <tr> <th>ASI MN</th> <th>OEM PN</th> <th>Description</th> </tr> <tr> <td>ASI-4274-001</td> <td>609-4274-001</td> <td>Calibrated Test Weight, 1 lb</td> </tr> <tr> <td>ASI-4276-001</td> <td>609-4276-001</td> <td>Calibrated Test Weight, 2 lb</td> </tr> <tr> <td>ASI-4278-001</td> <td>609-4278-001</td> <td>Calibrated Test Weight, 10 lb</td> </tr> <tr> <td>ASI-4292-001</td> <td>609-4292-001</td> <td>Calibrated Test Weight, 1.3 oz</td> </tr> <tr> <td>ASI-4292-002</td> <td>609-4292-002</td> <td>Calibrated Test Weight, 0.6 oz</td> </tr> </table>	ASI MN	OEM PN	Description	ASI-4274-001	609-4274-001	Calibrated Test Weight, 1 lb	ASI-4276-001	609-4276-001	Calibrated Test Weight, 2 lb	ASI-4278-001	609-4278-001	Calibrated Test Weight, 10 lb	ASI-4292-001	609-4292-001	Calibrated Test Weight, 1.3 oz	ASI-4292-002	609-4292-002	Calibrated Test Weight, 0.6 oz							
		ASI MN	OEM PN	Description																							
ASI-4274-001	609-4274-001	Calibrated Test Weight, 1 lb																									
ASI-4276-001	609-4276-001	Calibrated Test Weight, 2 lb																									
ASI-4278-001	609-4278-001	Calibrated Test Weight, 10 lb																									
ASI-4292-001	609-4292-001	Calibrated Test Weight, 1.3 oz																									
ASI-4292-002	609-4292-002	Calibrated Test Weight, 0.6 oz																									
		Optional Equipment:																									
		<table border="0"> <tr> <th>ASI MN</th> <th>OEM PN</th> <th>Description</th> </tr> <tr> <td>ASI-213-1</td> <td>608-3617-001</td> <td>334C-6 / SVO-80 Servo Loop Test Panel</td> </tr> <tr> <td>ASI-213-2</td> <td>637-0789-001</td> <td>334C-6 / SVO-80 Min. Performance Test Set</td> </tr> </table>	ASI MN	OEM PN	Description	ASI-213-1	608-3617-001	334C-6 / SVO-80 Servo Loop Test Panel	ASI-213-2	637-0789-001	334C-6 / SVO-80 Min. Performance Test Set																
ASI MN	OEM PN	Description																									
ASI-213-1	608-3617-001	334C-6 / SVO-80 Servo Loop Test Panel																									
ASI-213-2	637-0789-001	334C-6 / SVO-80 Min. Performance Test Set																									
Torque Tester		ASI-212-2																									
OEM Equivalent: Rockwell Collins MN: 960M-2 PN: 622-2094-001 Manual: 523-0765446 Manual Figure: 1	UUT: 334C-9/9A 334D-6/-6A/-6B/-6C Size: H: 7.25" W: 27.25" D: 8.50" Pwr: None	Equipment Supplied:																									
Description: The ASI-212-2 Torque Tester is a precision balance-beam torque measuring device used in conjunction with the ASI-206 (972S-3) for testing, troubleshooting, and overhaul of the Collins 334C-9() and 334D-6() Primary and Trim Servos. The Torque Tester consists of a mounting base, servo mounting base, calibrated balance beam, and test weights. See the ASI-206 catalog page for optional servo/servo mount tools and equipment.		<table border="0"> <tr> <th>ASI MN</th> <th>OEM PN</th> <th>Description</th> </tr> <tr> <td>ASI-9113-001</td> <td>621-9113-001</td> <td>Calibrated Test Weight, 1 lb</td> </tr> <tr> <td>ASI-9113-002</td> <td>621-9113-002</td> <td>Calibrated Test Weight, 3 lb</td> </tr> <tr> <td>ASI-9113-003</td> <td>621-9113-003</td> <td>Calibrated Test Weight, 0.5 lb</td> </tr> </table>	ASI MN	OEM PN	Description	ASI-9113-001	621-9113-001	Calibrated Test Weight, 1 lb	ASI-9113-002	621-9113-002	Calibrated Test Weight, 3 lb	ASI-9113-003	621-9113-003	Calibrated Test Weight, 0.5 lb													
		ASI MN	OEM PN	Description																							
ASI-9113-001	621-9113-001	Calibrated Test Weight, 1 lb																									
ASI-9113-002	621-9113-002	Calibrated Test Weight, 3 lb																									
ASI-9113-003	621-9113-003	Calibrated Test Weight, 0.5 lb																									
		Optional Equipment:																									
		<table border="0"> <tr> <th>ASI MN</th> <th>OEM PN</th> <th>Description</th> </tr> <tr> <td>ASI-205</td> <td>622-1668-001</td> <td>Autopilot Bench Test Panel (972S-2)</td> </tr> <tr> <td>ASI-206</td> <td>622-2562-001</td> <td>Servo Test Set (972S-3)</td> </tr> </table>	ASI MN	OEM PN	Description	ASI-205	622-1668-001	Autopilot Bench Test Panel (972S-2)	ASI-206	622-2562-001	Servo Test Set (972S-3)																
ASI MN	OEM PN	Description																									
ASI-205	622-1668-001	Autopilot Bench Test Panel (972S-2)																									
ASI-206	622-2562-001	Servo Test Set (972S-3)																									
Torque Tester		ASI-212-3																									
OEM Equivalent: Rockwell Collins MN: 960M-3 PN: 622-2741-001 Manual: 523-0766582 Manual Figure: 1	UUT: 334C-9/-9A/-11/-12H / 334D-6/-6A/-6B/-6C SVO-830/-830A / SVO-65/-75 (With Mod Kit) Size: H: 12.00" W: 30.00" D: 6.50" Pwr: None	Equipment Supplied:																									
Description: The ASI-212-3 (Previously listed as ASI-189) Torque Tester is a precision balance-beam torque measuring device used in conjunction with the ASI-206 (972S-3) for testing, troubleshooting, and overhaul of the Collins Primary and Trim Servos. The Torque Tester consists of a mounting base, servo mounting base, calibrated balance beam, and test weights. The ASI-212-3 requires the optional modification kit (ASI-18-9A) in order to test the SVO-65/-75 Servos. A modified 960M-3 is equivalent to the 960M-5 (ASI-212-5) See the ASI-206 or ASI-348 catalog pages for optional servo/servo mount tools and equipment.		<table border="0"> <tr> <th>ASI MN</th> <th>OEM PN</th> <th>Description</th> </tr> <tr> <td>ASI-9113-001</td> <td>621-9113-001</td> <td>Calibrated Test Weight, 1 lb</td> </tr> <tr> <td>ASI-9113-002</td> <td>621-9113-002</td> <td>Calibrated Test Weight, 3 lb</td> </tr> <tr> <td>ASI-9113-003</td> <td>621-9113-003</td> <td>Calibrated Test Weight, 0.5 lb</td> </tr> <tr> <td>ASI-9113-004</td> <td>621-9113-004</td> <td>Calibrated Test Weight, 2 lb</td> </tr> <tr> <td>ASI-9113-006</td> <td>621-9113-006</td> <td>Calibrated Test Weight, 0.25 lb</td> </tr> </table>	ASI MN	OEM PN	Description	ASI-9113-001	621-9113-001	Calibrated Test Weight, 1 lb	ASI-9113-002	621-9113-002	Calibrated Test Weight, 3 lb	ASI-9113-003	621-9113-003	Calibrated Test Weight, 0.5 lb	ASI-9113-004	621-9113-004	Calibrated Test Weight, 2 lb	ASI-9113-006	621-9113-006	Calibrated Test Weight, 0.25 lb							
		ASI MN	OEM PN	Description																							
ASI-9113-001	621-9113-001	Calibrated Test Weight, 1 lb																									
ASI-9113-002	621-9113-002	Calibrated Test Weight, 3 lb																									
ASI-9113-003	621-9113-003	Calibrated Test Weight, 0.5 lb																									
ASI-9113-004	621-9113-004	Calibrated Test Weight, 2 lb																									
ASI-9113-006	621-9113-006	Calibrated Test Weight, 0.25 lb																									
		Optional Equipment:																									
		<table border="0"> <tr> <th>ASI MN</th> <th>OEM PN</th> <th>Description</th> </tr> <tr> <td>ASI-205</td> <td>622-1668-001</td> <td>Autopilot Bench Test Panel (972S-2)</td> </tr> <tr> <td>ASI-206</td> <td>622-2562-001</td> <td>Servo Loop Test Set (972S-3)</td> </tr> <tr> <td>ASI-18-9A</td> <td>622-6454-002</td> <td>SVO-65/75 Mod Kit for ASI-212-3 / 960M-3</td> </tr> <tr> <td>ASI-18-9B</td> <td>634-2835-001</td> <td>SMT-65() Capstan Holding Fixture</td> </tr> <tr> <td>ASI-18-9C</td> <td>634-2830-001</td> <td>SMT-65E Capstan Holding Fixture</td> </tr> <tr> <td>ASI-246-1</td> <td>621-9185-001</td> <td>Capstan Clutch Adjustment Fixture (16 tooth)</td> </tr> <tr> <td>ASI-246-2</td> <td>621-9185-002</td> <td>Capstan Clutch Adjustment Fixture (14 tooth)</td> </tr> </table>	ASI MN	OEM PN	Description	ASI-205	622-1668-001	Autopilot Bench Test Panel (972S-2)	ASI-206	622-2562-001	Servo Loop Test Set (972S-3)	ASI-18-9A	622-6454-002	SVO-65/75 Mod Kit for ASI-212-3 / 960M-3	ASI-18-9B	634-2835-001	SMT-65() Capstan Holding Fixture	ASI-18-9C	634-2830-001	SMT-65E Capstan Holding Fixture	ASI-246-1	621-9185-001	Capstan Clutch Adjustment Fixture (16 tooth)	ASI-246-2	621-9185-002	Capstan Clutch Adjustment Fixture (14 tooth)	
ASI MN	OEM PN	Description																									
ASI-205	622-1668-001	Autopilot Bench Test Panel (972S-2)																									
ASI-206	622-2562-001	Servo Loop Test Set (972S-3)																									
ASI-18-9A	622-6454-002	SVO-65/75 Mod Kit for ASI-212-3 / 960M-3																									
ASI-18-9B	634-2835-001	SMT-65() Capstan Holding Fixture																									
ASI-18-9C	634-2830-001	SMT-65E Capstan Holding Fixture																									
ASI-246-1	621-9185-001	Capstan Clutch Adjustment Fixture (16 tooth)																									
ASI-246-2	621-9185-002	Capstan Clutch Adjustment Fixture (14 tooth)																									
Torque Tester		ASI-212-4																									
OEM Equivalent: Rockwell Collins MN: 960M-4 PN: 622-5434-001 Manual: 523-0773344 Manual Figure: 1	UUT: SVO-85A/-85B/-85C SVO-1000 Size: H: 6.00" W: 46.00" D: 10.00" Pwr: None	Equipment Supplied:																									
Description: The ASI-212-4 Torque Tester is a precision balance-beam torque measuring device used in conjunction with the ASI-403-1/-2 for testing, troubleshooting, and overhaul of the Collins SVO-85() and SVO-1000 Primary Servos. The Torque Tester consists of a mounting base, servo mounting plate, balance beam, calibrated test weights, capstan adjustment fixture, and capstan adjustment wrench. See the ASI-403 catalog page for optional servo/servo mount tools and equipment.		<table border="0"> <tr> <th>ASI MN</th> <th>OEM PN</th> <th>Description</th> </tr> <tr> <td>ASI-4273-001</td> <td>609-4273-001</td> <td>Calibrated Test Weight, 1 lb</td> </tr> <tr> <td>ASI-4275-001</td> <td>609-4275-001</td> <td>Calibrated Test Weight, 2 lb</td> </tr> <tr> <td>ASI-4277-001</td> <td>609-4277-001</td> <td>Calibrated Test Weight, 10 lb</td> </tr> <tr> <td>ASI-4292-001</td> <td>609-4292-001</td> <td>Calibrated Test Weight, 1.3 oz</td> </tr> <tr> <td>ASI-4292-002</td> <td>609-4292-002</td> <td>Calibrated Test Weight, 0.6 oz</td> </tr> <tr> <td>ASI-21-24C</td> <td>634-1723-001</td> <td>Capstan Adjustment Wrench (p/o ASI-21-24A)</td> </tr> <tr> <td>ASI-21-24A</td> <td>634-1773-001</td> <td>Capstan Torque Adjust Fixture</td> </tr> </table>	ASI MN	OEM PN	Description	ASI-4273-001	609-4273-001	Calibrated Test Weight, 1 lb	ASI-4275-001	609-4275-001	Calibrated Test Weight, 2 lb	ASI-4277-001	609-4277-001	Calibrated Test Weight, 10 lb	ASI-4292-001	609-4292-001	Calibrated Test Weight, 1.3 oz	ASI-4292-002	609-4292-002	Calibrated Test Weight, 0.6 oz	ASI-21-24C	634-1723-001	Capstan Adjustment Wrench (p/o ASI-21-24A)	ASI-21-24A	634-1773-001	Capstan Torque Adjust Fixture	
		ASI MN	OEM PN	Description																							
ASI-4273-001	609-4273-001	Calibrated Test Weight, 1 lb																									
ASI-4275-001	609-4275-001	Calibrated Test Weight, 2 lb																									
ASI-4277-001	609-4277-001	Calibrated Test Weight, 10 lb																									
ASI-4292-001	609-4292-001	Calibrated Test Weight, 1.3 oz																									
ASI-4292-002	609-4292-002	Calibrated Test Weight, 0.6 oz																									
ASI-21-24C	634-1723-001	Capstan Adjustment Wrench (p/o ASI-21-24A)																									
ASI-21-24A	634-1773-001	Capstan Torque Adjust Fixture																									
		Optional Equipment:																									
		<table border="0"> <tr> <th>ASI MN</th> <th>OEM PN</th> <th>Description</th> </tr> <tr> <td>ASI-21-24B</td> <td>634-1773-002</td> <td>Capstan Torque Adjustment Fixture</td> </tr> <tr> <td>ASI-246-3</td> <td>822-0030-001</td> <td>Servo Mount Test Adapter (997T-1)</td> </tr> <tr> <td>ASI-403-1</td> <td>622-7122-001</td> <td>Servo Test Panel (972S-5)</td> </tr> </table>	ASI MN	OEM PN	Description	ASI-21-24B	634-1773-002	Capstan Torque Adjustment Fixture	ASI-246-3	822-0030-001	Servo Mount Test Adapter (997T-1)	ASI-403-1	622-7122-001	Servo Test Panel (972S-5)													
ASI MN	OEM PN	Description																									
ASI-21-24B	634-1773-002	Capstan Torque Adjustment Fixture																									
ASI-246-3	822-0030-001	Servo Mount Test Adapter (997T-1)																									
ASI-403-1	622-7122-001	Servo Test Panel (972S-5)																									
Torque Tester		ASI-212-5																									
OEM Equivalent: Rockwell Collins MN: 960M-5 (Modified 960M-3) PN: 622-6454-001 Manual: 523-0766582 Manual Figure: 2	UUT: SVO-65 / SVO-75 / SVO-3000 SVT-1000A / SVT-1000B Size: H: 12.00" W: 30.00" D: 6.50" Pwr: None	Equipment Supplied:																									
Description: The ASI-212-5 Torque Tester is a precision balance-beam torque measuring device used for testing, troubleshooting, and overhaul of Collins Servos. The Torque Tester consists of a mounting base, servo mounting plate, calibrated balance beam, test weights and capstan test fixture. The ASI-212-5 (960M-5) is also equivalent to the Collins Modified 960M-3 (with modification kit 622-6454-002). See the ASI-403 or ASI-348 catalog pages for optional servo/servo mount tools and equipment.		<table border="0"> <tr> <th>ASI MN</th> <th>OEM PN</th> <th>Description</th> </tr> <tr> <td>ASI-9113-001</td> <td>621-9113-001</td> <td>Calibrated Test Weight, 1 lb</td> </tr> <tr> <td>ASI-9113-002</td> <td>621-9113-002</td> <td>Calibrated Test Weight, 3 lb</td> </tr> <tr> <td>ASI-9113-003</td> <td>621-9113-003</td> <td>Calibrated Test Weight, 0.5 lb</td> </tr> <tr> <td>ASI-9113-004</td> <td>621-9113-004</td> <td>Calibrated Test Weight, 2 lb</td> </tr> <tr> <td>ASI-9113-006</td> <td>621-9113-006</td> <td>Calibrated Test Weight, 0.25 lb</td> </tr> <tr> <td>ASI-246-2</td> <td>621-9185-002</td> <td>Capstan Test Fixture (14 Tooth)</td> </tr> </table>	ASI MN	OEM PN	Description	ASI-9113-001	621-9113-001	Calibrated Test Weight, 1 lb	ASI-9113-002	621-9113-002	Calibrated Test Weight, 3 lb	ASI-9113-003	621-9113-003	Calibrated Test Weight, 0.5 lb	ASI-9113-004	621-9113-004	Calibrated Test Weight, 2 lb	ASI-9113-006	621-9113-006	Calibrated Test Weight, 0.25 lb	ASI-246-2	621-9185-002	Capstan Test Fixture (14 Tooth)				
		ASI MN	OEM PN	Description																							
ASI-9113-001	621-9113-001	Calibrated Test Weight, 1 lb																									
ASI-9113-002	621-9113-002	Calibrated Test Weight, 3 lb																									
ASI-9113-003	621-9113-003	Calibrated Test Weight, 0.5 lb																									
ASI-9113-004	621-9113-004	Calibrated Test Weight, 2 lb																									
ASI-9113-006	621-9113-006	Calibrated Test Weight, 0.25 lb																									
ASI-246-2	621-9185-002	Capstan Test Fixture (14 Tooth)																									
		Optional Equipment:																									
		<table border="0"> <tr> <th>ASI MN</th> <th>OEM PN</th> <th>Description</th> </tr> <tr> <td>ASI-348-1</td> <td>NPN</td> <td>SVO-65 Primary Servo Test Panel</td> </tr> <tr> <td>ASI-348-2</td> <td>NPN</td> <td>SVT-1000A/-1000B Adapter Panel</td> </tr> <tr> <td>ASI-403-1</td> <td>622-7122-001</td> <td>Servo Test Panel (972S-5)</td> </tr> <tr> <td>ASI-403-2</td> <td>622-7122-002</td> <td>Servo Test Panel (972S-5)</td> </tr> </table>	ASI MN	OEM PN	Description	ASI-348-1	NPN	SVO-65 Primary Servo Test Panel	ASI-348-2	NPN	SVT-1000A/-1000B Adapter Panel	ASI-403-1	622-7122-001	Servo Test Panel (972S-5)	ASI-403-2	622-7122-002	Servo Test Panel (972S-5)										
ASI MN	OEM PN	Description																									
ASI-348-1	NPN	SVO-65 Primary Servo Test Panel																									
ASI-348-2	NPN	SVT-1000A/-1000B Adapter Panel																									
ASI-403-1	622-7122-001	Servo Test Panel (972S-5)																									
ASI-403-2	622-7122-002	Servo Test Panel (972S-5)																									

Servo Loop Test Panel

ASI-213-1

OEM Equivalent: Rockwell Collins
 MN: NMN
 PN: 608-3617-001
 Manual: 523-0762690 / 523-0766552
 Manual Figure: 1012-1013 / 5-14 - 5-15

UUT: 334C-6/-6A/-6B/-6C/-6D
 SVO-80/-80A/-80B/-80C
 Size: H: 5.25" W: 19.00" D: 7.00"
 Pwr: 28 VDC / 115 VAC 400Hz

Description:
 The ASI-213-1 Servo Loop Test Panel works in conjunction with the ASI-212-1 (960M-1) to facilitate testing, alignment, and overhaul of the Collins 334C-6(0 and SVO-80() Primary Servos. The Test Panel provides all power, switching, loading, and monitoring test points required during testing of the servo.

The ASI-213-1 includes the interconnect cable (ASI-21-3A) required to interface the test panel to the uut.

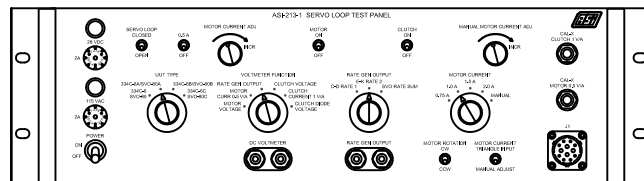

Optional Equipment:

ASI MN	OEM PN	Description
ASI-212-1	622-0471-001	334C-6 / SVO-80 Torque Tester (960M-1)
ASI-230	229-0223-030	Large / Motor Flux Keeper Ring (A-14526)
ASI-232	229-9515-050	Small / Generator Flux Keeper Ring (A-3426)
ASI-21-3B	628-5151-001	Servo Mount Holding Fixture for 351B-6J/K/L/M
ASI-21-3C	608-3945-001	Servo Mount Holding Fixture
ASI-21-3D	608-4005-001	334C-6/SVO-80 Adapter Hub
ASI-21-3E	608-4006-001	334C-6/SVO-80 Spanner Wrench
ASI-21-3F	608-4699-001	334C-6/SVO-80 Backlash Test Fixture
ASI-21-3G	NPN	Pin Removal Fixture (334C-6 Man. Fig. 1011)

Equipment Supplied:

ASI MN	OEM PN	Description
ASI-21-3A	NPN	Cable, ASI-213-1 to 334C-6 / SVO-80

Minimum Performance Test Set

ASI-213-2

OEM Equivalent: Rockwell Collins
 MN: NMN
 PN: 637-0789-001
 Manual: 523-0762690 / 523-0766552
 Manual Figure: 1008-1010 / 5-6 - 5-7

UUT: 334C-6/-6A/-6B/-6C/-6D
 SVO-80/-80A/-80B/-80C
 Size: H: 3.00" W: 7.00" D: 5.00"
 Pwr: 28 VDC

Description:
 The ASI-213-2 Servo Test Set works in conjunction with the ASI-212-1 (960M-1) to provide minimum performance (customer acceptance) testing of the Collins 334C-6() and SVO-80() Primary Servos. The Test Panel provides all power, switching, loading, and monitoring test points required during testing of the servo.

The ASI-213-2 includes the interconnect cable (ASI-21-32A) required to interface the test panel to the uut.

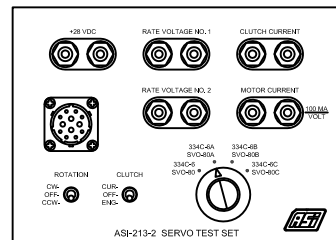

Optional Equipment:

ASI MN	OEM PN	Description
ASI-212-1	622-0471-001	334C-6 / SVO-80 Torque Tester (960M-1)
ASI-230	229-0223-030	Large / Motor Flux Keeper Ring (A-14526)
ASI-232	229-9515-050	Small / Generator Flux Keeper Ring (A-3426)
ASI-21-3B	628-5151-001	Servo Mount Holding Fixture for 351B-6J/K/L/M
ASI-21-3C	608-3945-001	Servo Mount Holding Fixture
ASI-21-3D	608-4005-001	334C-6/SVO-80 Adapter Hub
ASI-21-3E	608-4006-001	334C-6/SVO-80 Spanner Wrench
ASI-21-3F	608-4699-001	334C-6/SVO-80 Backlash Test Fixture
ASI-21-3G	NPN	Pin Removal Fixture (334C-6 Man. Fig. 1011)

Equipment Supplied:

ASI MN	OEM PN	Description
ASI-21-32A	NPN	Cable, ASI-213-2 to 334C-6 / SVO-80

TDR-94/94D Flightline Test Set

ASI-214

OEM Equivalent: Rockwell Collins
 MN: NMN
 PN: NPN
 Manual: 523-0775652
 Manual Figure: 5-11 - 5-22

UUT: TDR-94
 TDR-94D
 Size: H: 12.00" W: 8.00" D: 3.00"
 Pwr: From UUT

Description:
 The ASI-214 Flightline Test Set is used for in-aircraft testing and fault isolation of the Collins TDR-94/94D Mode S Transponder system.

The ASI-214 plugs directly between the aircraft wiring harness and the system control head to provide a quick and easy way to determine which component of the transponder system is malfunctioning. Complete testing requires an ARINC 429 Bus Reader and a Digital Volt Meter.

The ASI-214 requires a ASI-21-4x Test Kit for proper operation. Test kit selection is dependent upon which control head is installed in the aircraft. Each test kit includes aircraft and control head interconnect cables and a test panel overlay.

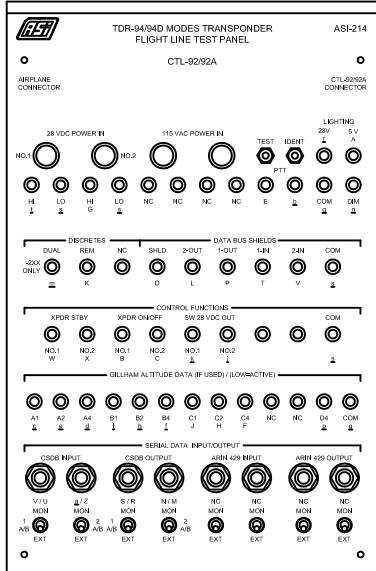

Optional Equipment :

ASI MN	OEM PN	Description
ASI-21-4A	NPN	Test Kit for Collins CTL-92/92A Control Head
ASI-21-4B	NPN	Test Kit for Collins CTL-92T Control Head
ASI-21-4C	NPN	Test Kit for Collins RTU-870A/T Control Head
ASI-21-4D	NPN	Test Kit for Collins TTC-920G Control Head
ASI-CTS-940	628-8750-001	TDR-94/94D Transponder Test Panel
ASI-CTS-941AR	NPN	TDR-94/94D Transponder Test Panel

ASI-215

Synchro/Resolver/Control Transformer Test Panel

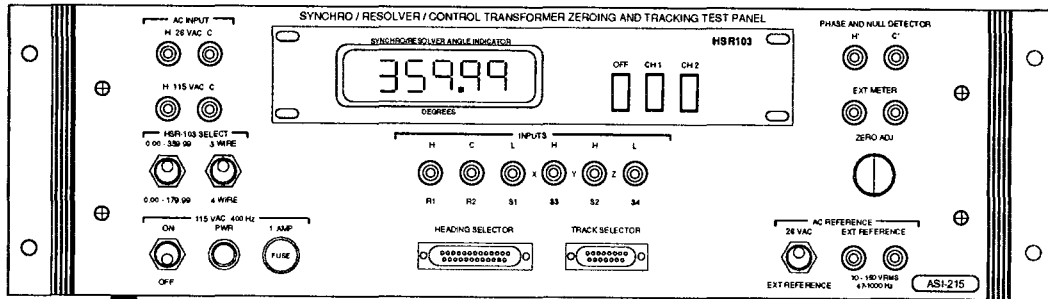

Description of Operation:

The ASI-215 is configured to facilitate testing and alignment of synchros, resolvers, and control transformers. It can also be used for the calibration of heading and track selectors including the entire line of ASI Universal Track and Heading Selectors.

The ASI-215 allows easy interfacing of synchro/resolver information to a user-supplied HSR-103 or equivalent. The Test Panel also has phase and null detector outputs, and can test or align either 3-wire or 4-wire units.

The Test Panel comes complete with the following cables:

MN	Description
ASI-21-5A	ASI-215 to ASI-140, 160, 160B, 160C
ASI-21-5B	ASI-215 to ASI-150, 160, 160B, 160C, 190, 190B

Size: H-8.75" W-19.0" D-14.0"

Power Requirements: 115 VAC, 57-500 Hz.

Optional Items Available:

ASI-216 Internal Data Bus Simulator

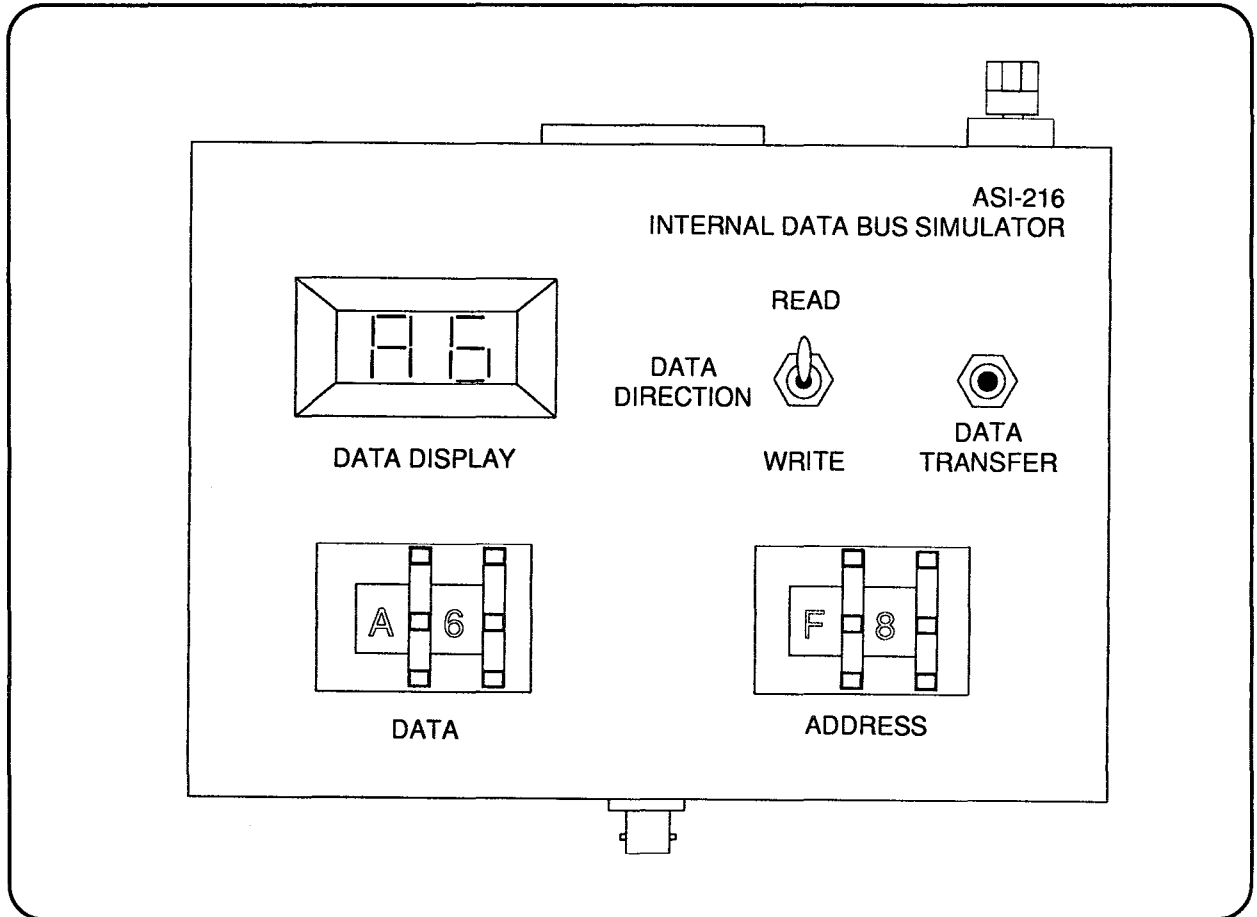

Description of Operation:

The ASI-216 Internal Data Bus Simulator is used to facilitate the testing of peripheral modules within the IFR ATC-1400 Transponder/DME Test Set. It enables the technician to write selected data to a particular address by means of hexadecimal thumbwheel switches. Data can also be read from the module under test and shown on an LED display, depending on the position of the data direction switch.

The ASI-216 is interchangeable Form, Fit, and Function with the Internal Data Bus Simulator shown in Appendix I of the ATC-1400 manual and is one of the recommended test accessories specified in the Module Testing section.

Size: H-4.75" W-6.0" D-4.0"

Power Requirements: 28 VDC

Optional Items Available:

Pro Line

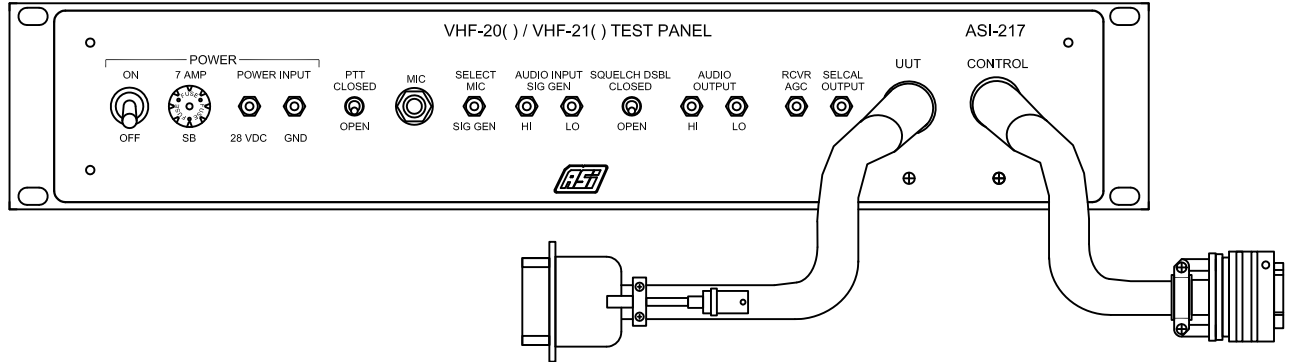

OEM Equivalent:

OEM: Rockwell Collins
 Model Number:
 Part Number:
 Manual: 523-0763323 / 523-0765213 / 523-0771858
 Manual Figure: 1002 / Maintenance Section 1 - 2 / 5-7

This unit is manufactured to replace the OEM MN, PN, and/or manual figure listed in Form, Fit, and Function.

Units Tested:

VHF-20 / VHF-20A / VHF-20B
 VHF-21 / VHF-21A / VHF-21B / VHF-21C / VHF-21D

Description:

The ASI-217 VHF-20/VHF-21 Test Panel provides signals and feedback required for testing, troubleshooting, and alignment of the Collins VHF-20/VHF-21 COM Transceiver.

The test panel comes complete with hardwired UUT and control head (313N-2/4/5) cabling. An adapter cable (ASI-21-7A) is also available in order to use a CTL-22 in place of the 313N-2/4/5.

A user supplied 313N-2/4/5 control head or CTL-22 (with ASI-21-7A) is required for proper operation. The ASI-501-3 COM Control Head Simulator may be substituted for the 313N-2/4/5 control head.

Equipment Supplied:

<u>ASI MN</u>	<u>OEM PN</u>	<u>Description</u>

Optional Equipment:

<u>ASI MN</u>	<u>OEM PN</u>	<u>Description</u>
ASI-21-7A	NPN	Adapter Cable: ASI-217 to CTL-22
ASI-501-3	NPN	COM Control Head Simulator

Specifications:

Height: 3.50" Width: 19.00" Depth: 5.00"
 Power Requirements: 28 VDC

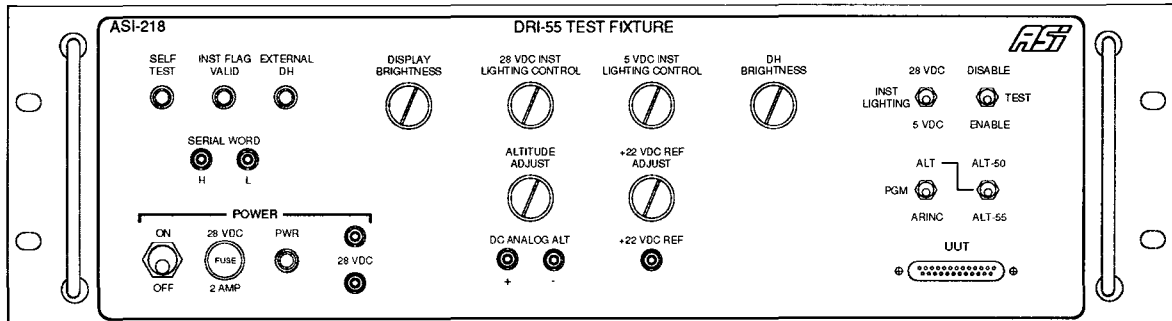

This unit is manufactured to replace the OEM model and/or part number listed below in form, fit, and function.

Equivalent OEM: Collins

Units Tested:

Equivalent MN:

DRI-55 Digital Radio Altimeter

Equivalent PN:

Manual Figure: DRI-55, Fig. 5-2, 5-3

Description of Operation:

The ASI-218 Test Panel provides all signals and feedback required for testing, alignment and troubleshooting of the Collins DRI-55 Digital Radio Altimeter. The Test Panel comes with DRI-55 cable.

Optional Cables (ASI-21-8B and ASI-21-8C) are available for circuit card testing.

Specifications:

Height: 3.50" Width: 19.00" Depth: 5.00" Power: 28 VDC

Equipment Supplied:

ASI MN	Equivalent PN	Description
ASI-21-8A		Cable: ASI-218 to DRI-55

Optional Equipment:

ASI MN	Equivalent PN	Description
ASI-21-8B		Cable: Circuit Analysis
ASI-21-8C		Cable: One to One

Pro Line

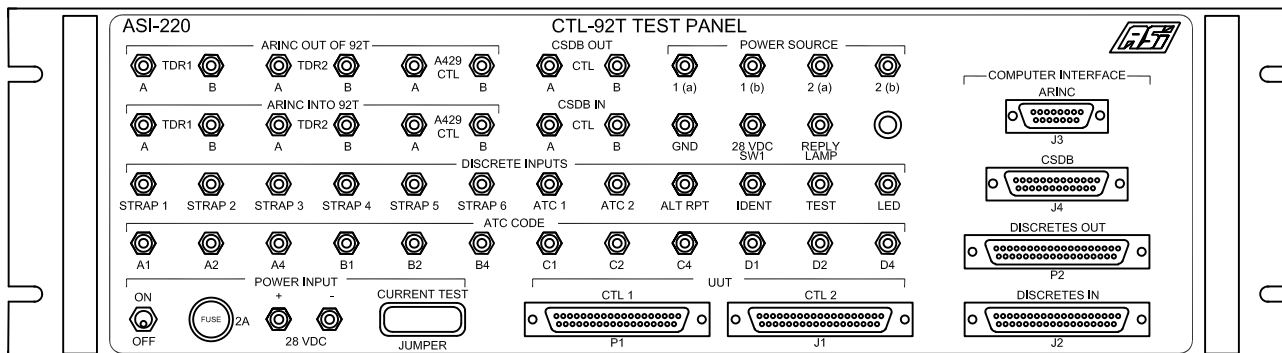

OEM Equivalent:
 OEM: Rockwell Collins
 Model Number:
 Part Number:
 Manual: 523-0776595
 Manual Figure: 901-903

This unit is manufactured to replace the OEM MN, PN, and/or manual figure listed in Form, Fit, and Function.

Description:
 The ASI-220 Test Panel provides an interface between the CTL-92T TCAS Control and the data bus simulator required for testing. The ASI-220 duplicates the performance of the CTL-92T Test Set shown in the Collins maintenance manual. The test panel includes all test points and discretes required to test the CTL-92T

The ASI-220 is supplied with a CTL-92T Test Cable (ASI-22-0A).

The ASI-401 is required to interface ASI-220 to the data bus simulator (PC computer) The test program (523-0777-537) required for testing must be purchased direct from Collins to insure latest software revision.

Units Tested:
 CTL-92T

Test Software:
 523-0777-537 CTL-92T Test Program (PC)

Equipment Supplied:

ASI MN	OEM PN	Description
ASI-22-0A	NPN	Cable: ASI-220 to CTL-92T

Optional Equipment:

ASI MN	OEM PN	Description
ASI-401-1	NPN	Pro Line / PC Interface Panel
CTC-429	822-0854-001	ARINC 429/CSDB Computer Card

Specifications:
 Height: 5.25" Width: 19.00" Depth: 7.00"
 Power Requirements: 28 VDC

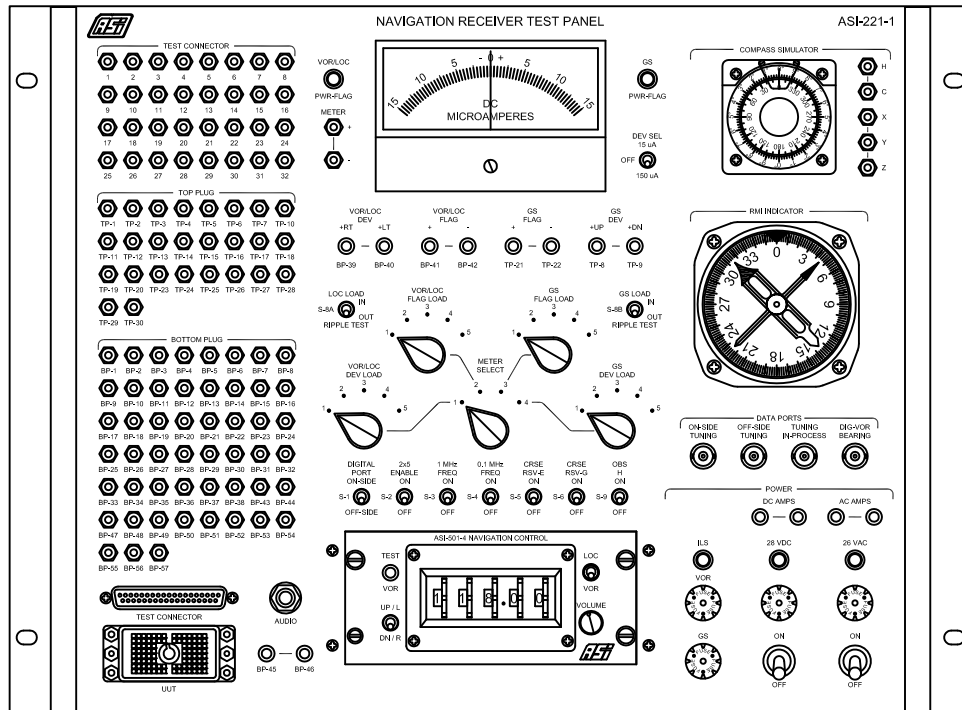

OEM Equivalent:

OEM: Collins
 Model Number: 968Y-1
 Part Number:
 Manual Figure: 523-0768547 / 51R-10/10() Fig. 902-905
 523-0767346 / 51RV-4()/5() Fig. 903-906

This unit is manufactured to replace the OEM MN, PN, and/or manual figure listed in Form, Fit, and Function.

Units Tested:

ARINC 500 Series Navigation Receivers
 51R-10 / 51R-10A / 51R-10B
 51R-11 / 51R-11A / 51R-11B
 51RV-2 / 51RV-2B
 51RV-4 / 51RV-4B / 51RV-4D
 51RV-5 / 51RV-5B / 51RV-5D

Description:

The ASI-221-1 is a universal test panel for ARINC 500 series navigation receivers. The ASI-221-1 will test the Collins 51R/51RV series and most other ARINC 500 standard navigation receivers.

The ASI-221-1 includes the following features:

- * Compass Simulator for control of RMI compass card.
- * VOR-LOC/GS deviation/flag meter with multiple load switching.
- * Test Points for all pins in the UUT and Test connectors.
- * VOR-LOC/GS super flag output indicator lamps.
- * ILS indicator lamp to indicate ILS mode of operation.
- * Control unit (user supplied) for selecting frequency.
- * RMI (user supplied) indicates relative bearing.
- * Phone jack / test points for measuring VOR/LOC receiver audio.
- * UUT test cable (ASI-22-11A) for navigation receiver under test.
- * Two Test Conn. cables, 32P (ASI-22-11B) and 25P (ASI-22-11C).
- * Breakout Box/Adapter Cable functions added.
- * Data ports added for receivers with serial tuning option.
- * Data port added for receivers with digital bearing output option.

The ASI-221-1 includes a control head simulator (ASI-501-4). A 313N-3 (or equivalent) may also be used if desired. A user supplied RMI (332C-2, IN-16A, 2105, 2108, 36105, 36108 or equivalent) is required for proper operation.

A track selector is also required for testing. Adapter cables that mate the ASI-221-1 to the ASI-161, 479V-3 or ASI-190 are available. See the optional equipment section for more information.

Equipment Supplied:

ASI MN	OEM PN	Description
ASI-22-11A	NPN	Cable: ASI-221-1 to UUT
ASI-22-11B	NPN	Cable: ASI-221-1 to 32-Pin Test Conn.
ASI-22-11C	NPN	Cable: ASI-221-1 to 25-Pin Test Conn.
ASI-501-4	NPN	Nav Control Head Simulator

Optional Equipment:

ASI MN	OEM PN	Description
ASI-22-1E	NPN	Cable: ASI-221 to ASI-161 / 479V-3
ASI-22-1F	NPN	N1/N2 DC Source (51RV-4/5 Fig. 910-911)
ASI-22-1G	NPN	Synthesizer A18/A19 Extender Cable
ASI-161	522-1339-000	Precision Track Selector (479V-3)
ASI-280	NPN	CPU Test Set (51RV-4/5 Fig. 912-914)
ASI-0740-001	791-0740-001	Maintenance Kit: 51RV-2B
ASI-8048-001	791-8048-001	Slice Extender Kit: 51RV-2B

Specifications:

Height: 14.00" Width: 19.00" Depth: 10.00"
 Power Requirements: 115 VAC 400 Hz / 28 VDC

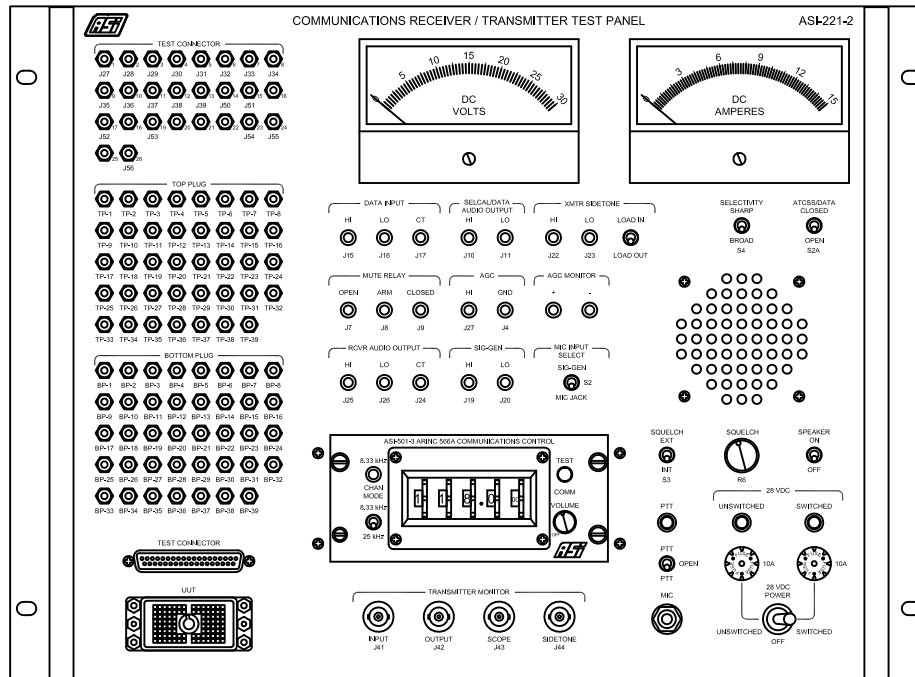

OEM Equivalent:

OEM: Rockwell Collins
 Model Number:
 Part Number:
 Manual Figure: 523-0756894 / 618M-1/1() Fig. 1001
 523-0758989 / 618M-2B/2D Fig. 902
 523-0758990 / 618M-2B/2D Fig. 1002
 523-0764898 / 618M-3()/4() Fig. 1003
 523-0778445 / 618M-5() Fig. 903

This unit is manufactured to replace the OEM MN, PN, and/or manual figure listed in Form, Fit, and Function.

Units Tested:

ARINC 566/566A VHF Communications Receiver / Transmitters
 618M-1()
 618M-2B / 618M-2D
 618M-3 / 618M-3A
 618M-4 / 618M-4A
 618M-5 / 618M-5A

Description:

The ASI-221-2 is a universal test panel for ARINC 566/566A VHF communication receiver / transmitters. The test panel tests Collins 618M-() series "by the book". The ASI-221-2 will also test most other ARINC 566/566A standard VHF communication receiver / transmitters.

The ASI-221-2 includes the following features:

- * UUT test cable (ASI-22-12A) for the unit under test.
- * ATE connector cable (ASI-22-12B).
- * DC voltage and current meters.
- * Test points for all UUT Rear and ATE connector contacts.
- * Built in speaker / audio amplifier.
- * Test Control (ASI-501-3) included.
- * Modulation monitor test fixture built into panel.
- * External squelch control.
- * Switched / Unswitched UUT power input

The supplied ASI-501-3 test control head provides all channeling required to test the UUT including ARINC 566A (8.33 kHz).

User supplied controls (313N-2, 313N-3, G7406, or equivalent) may also be utilized with the ASI-221-2. Use of the Gables G7406 will require the optional ASI-22-12C cable.

Equipment Supplied:

ASI MN	OEM PN	Description
ASI-22-12A	NPN	Cable: ASI-221-2 to UUT
ASI-22-12B	NPN	Cable: ASI-221-2 to 29-Pin Test Conn.
ASI-501-3	NPN	Test Control Head: ARINC 566A (8.33 kHz)

Optional Equipment:

ASI MN	OEM PN	Description
ASI-22-12C	NPN	Cable: ASI-221-2 to G7406

Specifications:

Height: 14.00" Width: 19.00" Depth: 10.00"
 Power Requirements: 28 VDC

Passenger Address Amplifier Test Panel

ASI-222-1

OEM Equivalent: Rockwell Collins MN: NMN PN: NPN Manual: 523-0768492 Manual Figure: 902-907	UUT: 346D-1A / 346D-1B 346D-2 / 346D-2B Size: H: 5.25" W: 19.00" D: 6.00" Pwr: 28 VDC / 115 VAC 400 Hz
---	---

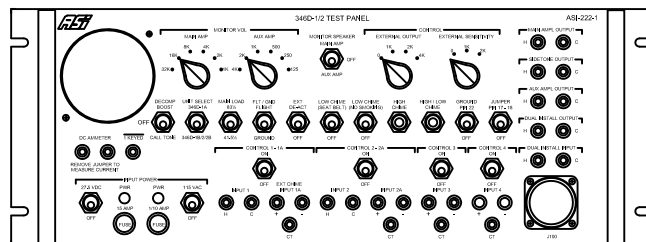

Description:
The ASI-222-1 Passenger Address Amplifier Test Panel functions to test, repair, and align the Collins 346D-1A, 346D-1B, 346D-2, and 346D-2B. The Test Panel includes the Monitor Speaker Panel functions along with the main amplifier, auxiliary amplifier, and sidetone loads. The cable required to test the 346D-1A/1B/2/2B is included with the test panel.

Equipment Supplied:		
<u>ASI MN</u>	<u>OEM PN</u>	<u>Description</u>
ASI-22-2A	NPN	Cable, ASI-222-1 to 346D-1A/1B/2/2B

Optional Equipment:		
<u>ASI MN</u>	<u>OEM PN</u>	<u>Description</u>
ASI-227	024-0458-000	Precision Trimmer/Capacitor Adjustment Tool
ASI-228	024-0817-000	Precision Potentiometer Adjustment Tool
ASI-720	NPN	26 dB L-Pad Attenuator (346D-2/2B Man Fig 908)

Zifor III VOR Radial Standard

ASI-223

OEM Equivalent: Rockwell Collins MN: 478A-3 PN: 622-3701-001 Manual: 523-0768823 Manual Figure: 1	UUT: Various Size: H: 5.50" W: 12.00" D: 16.50" Pwr: 115/230 VAC 50-60 Hz
---	---

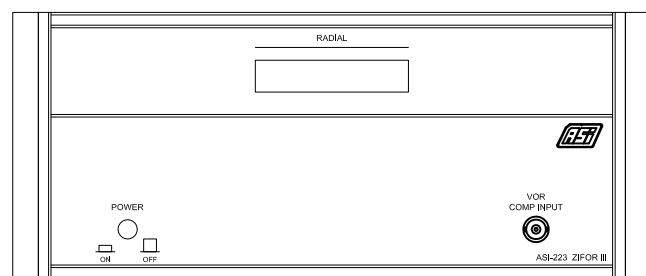

Description:
The ASI-223 Zifor III (Zero Indicator For OmniRange) is intended to be a VOR radial standard providing the measurement capability and tractability link between the reference standard and operational test equipment. The ASI-223 may be used to check the audio output of any VOR audio generators such as the Collins 479S-5/6() or the Bendix RVG-33.

The ASI-223 Zifor III demodulates and extracts bearing information from a VOR audio signal generator and displays the zero radial information to an accuracy of $\pm 0.01^\circ$. The ASI-223 also displays radial bearing run out error to within $\pm 0.01^\circ$ at any radial from 0.00 to 359.99°. Input signal status and automatic self-test information are also displayed. The ASI-223 Zifor III acts as a precise phase meter, measuring the phase relationship of the 30 Hz reference tone (which has been stripped from the 9960 Hz FM subcarrier) to the 30 Hz variable signal. The amplitude of the 30 Hz variable signal is also monitored to ensure that the input tones are within proper levels.

An RF Detector/Amplifier Module (ASI-22-3A1) is available as an option for testing VOR Signal Generators. The ASI-22-3A1 receives the RF input from a signal generator and filters out the VOR composite signals utilized by the ASI-223. The ASI-22-3A1 can be used externally on the bench or installed in the ASI-223, 478A-3, or 78A-3.

Equipment Supplied:		
<u>ASI MN</u>	<u>OEM PN</u>	<u>Description</u>

Optional Equipment:		
<u>ASI MN</u>	<u>OEM PN</u>	<u>Description</u>
ASI-22-3A1	01-0817-000	RF Detector/Amplifier Module

TACAN Test Panel

ASI-224

OEM Equivalent: Rockwell Collins MN: 972V-1 PN: 622-1789-001 Manual: 523-0768823 Manual Figure: 1	UUT: AN/ARN-118(V) / TCN-118 AN/ARN-139(V) Size: H: 14.12" W: 20.87" D: 20.87" Pwr: 115 VAC 400 Hz
---	---

TACAN System Components Tested on the ASI-224:
AN/ARN-118(V) / TCN-118
RT-1159/A / RT-1384/A / 374D-1 / 374D-2
C10056/A / C10057/A / C10058/A / C10059/A / C10060/A / C10061/A / C10062/A
C10782/A / C11840/A / C9603/A / 377J-1 / 377J-2 / 913G-1/-2/-3/-4
MX9577/A / MX11499/A / 899L-1
MX10070/A / MX10384/A / 998J-1

AN/ARN-139(V) (Requires optional ASI-226 Interface Panel)
RT-1385/A / 374D-3
C10994/A / 377J-3
MX-9577/A / MX11499/A / 899L-1
MX10191/A / 998M-1
AS-3508/A / 938J-1

Description:
ASI-224 TACAN Test Panel is used in conjunction with a TACAN station simulator to test the various components of the Rockwell Collins TCN-118, AN/ARN-118(V), and AN/ARN-139(V) Airborne TACAN systems.

The ASI-224 includes the Control/Display Unit, Interconnect Panel, Fault Isolation Unit, Extender Card and 7 Interconnect Cables.

The optional ASI-226 Interface Panel is required for testing the AN/ARN-139(V) system components.

Equipment Supplied:		
<u>ASI MN</u>	<u>OEM PN</u>	<u>Description</u>
ASI-22-4A	621-8134-001	Cable, ASI-224 to Control (W1)
ASI-22-4B	621-8132-001	Cable, ASI-224 to RT (W2)
ASI-22-4C	621-8133-001	Cable, ASI-224 to TACAN Adapter (W3)
ASI-22-4D	621-8164-001	Cable, ASI-224 to Ext AQU-2/A / AQU-4/A (W4)
ASI-22-4E	621-8135-002	Cable, ASI-224 to RT AGE (W5)
ASI-22-4F	621-8143-001	Cable, ASI-224 to AC Power (W6)
ASI-22-4G	621-8144-001	Cable, ASI-224 to Int AQU-2/A / AQU-4/A (W7)
ASI-224-1	629-0973-001	Interconnect Panel (255H-1)
ASI-224-2	622-1931-002	Control Display Unit (514M-1)
ASI-224-3	621-8100-002	Fault Isolation Unit
ASI-8938-001	618-8938-001	Extender Card

Optional Equipment:		
<u>ASI MN</u>	<u>OEM PN</u>	<u>Description</u>
ASI-22-6A	NPN	Cable, ASI-224 to 331A-8H (42")
ASI-22-6A1	629-9202-001	Cable, ASI-224 to 331A-8H (8")
ASI-22-6A2	629-9202-002	Cable, ASI-224 to 331A-8H (48")
ASI-22-6B	NPN	Cable, ASI-224 to AQU-6/A
ASI-22-6C	NPN	Cable, ASI-224 to 339D-1 / ID-250 / ID-1347
ASI-22-6D	NPN	Cable, ASI-224 to ID-1103 / ID-387
ASI-224-4	622-1930-001	Interconnect Panel with W1/2/3/6 (255H-1)
ASI-225	NPN	Interface Panel, ASI-224 to 899L-1
ASI-225-1	NPN	Alignment Fixture for 899L-1 / 998J-1
ASI-225-2	NPN	DC Supply Interface Fixture for 374D-1/2
ASI-225-3	NPN	AGE Breakout Box for 374D-1/2
ASI-226	622-7082-001	Interface Panel for AN/ARM-139(V) (514M-2)
ASI-227	024-0458-000	Tuning Tool
ASI-9305-118	629-9305-001	Maintenance Kit for TCN-118 / AN/ARM-118(V)

Test Interface Adapter ASI-225

OEM Equivalent: Collins MN: 687-8450-001 Manual: 523-0766389 Manual Figure: Maintenance Sec. Fig 3 Replaces ASI MN: ASI-322	UUT: 899L-1 (622-1678-004 Only) Size: H: 8.00" W: 10.00" D: 2.50" Pwr: From 972V-1	Equipment Supplied: <table border="1" style="width: 100%; border-collapse: collapse;"> <thead> <tr> <th style="text-align: left;">ASI MN</th> <th style="text-align: left;">OEM PN</th> <th style="text-align: left;">Description</th> </tr> </thead> <tbody> <tr> <td> </td> <td> </td> <td> </td> </tr> </tbody> </table>	ASI MN	OEM PN	Description															
ASI MN	OEM PN	Description																		
Description: The ASI-225 Test Interface Adapter adapts the Collins 972V-1 TACAN Test Set to the 899L-1 (-004) for testing purposes. The Test Interface Adapter provides all additional test signals and access to test point required to test 899L-1 (-004). Interconnection of the ASI-225 to the 972V-1 and 899L-1 is provided by pendant cables that extend from the Test Interface Adapter.		Optional Equipment: <table border="1" style="width: 100%; border-collapse: collapse;"> <thead> <tr> <th style="text-align: left;">ASI MN</th> <th style="text-align: left;">OEM PN</th> <th style="text-align: left;">Description</th> </tr> </thead> <tbody> <tr> <td>ASI-225-1</td> <td>NPN</td> <td>899L-1 / 998J-1 Alignment Fixture</td> </tr> <tr> <td>ASI-225-2</td> <td>NPN</td> <td>374D-1/-2 TACAN DC Supply Interface Fixture</td> </tr> <tr> <td>ASI-225-3</td> <td>NPN</td> <td>374D-1/-2 TACAN AGE Conn Breakout Box</td> </tr> <tr> <td>ASI-227</td> <td>024-0458-000</td> <td>Tuning Tool</td> </tr> <tr> <td>ASI-9305-118</td> <td>629-9305-001</td> <td>TCN-118 Maintenance Kit</td> </tr> </tbody> </table>	ASI MN	OEM PN	Description	ASI-225-1	NPN	899L-1 / 998J-1 Alignment Fixture	ASI-225-2	NPN	374D-1/-2 TACAN DC Supply Interface Fixture	ASI-225-3	NPN	374D-1/-2 TACAN AGE Conn Breakout Box	ASI-227	024-0458-000	Tuning Tool	ASI-9305-118	629-9305-001	TCN-118 Maintenance Kit
ASI MN	OEM PN	Description																		
ASI-225-1	NPN	899L-1 / 998J-1 Alignment Fixture																		
ASI-225-2	NPN	374D-1/-2 TACAN DC Supply Interface Fixture																		
ASI-225-3	NPN	374D-1/-2 TACAN AGE Conn Breakout Box																		
ASI-227	024-0458-000	Tuning Tool																		
ASI-9305-118	629-9305-001	TCN-118 Maintenance Kit																		

Interface Panel ASI-226

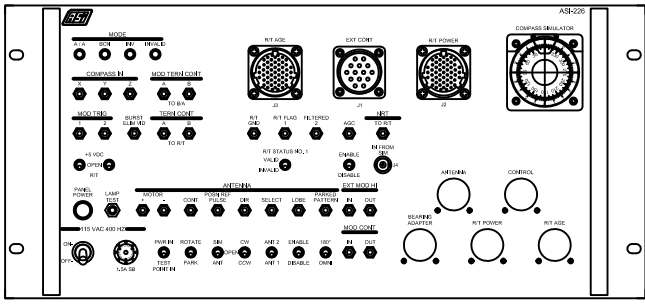
OEM Equivalent: Collins MN: 514M-2 PN: 622-7082-001 Manual: 523-0774083 Manual Figure: 1	UUT: AN/ARN-139(V) TACAN System 374D-3 / RT-1385/A / 377J-3 / C-10994/A 899L-1 / MX-9577/A / 938J-1 / 938Y-1 998M-1 / MX-10191/A Size: H: 8.75" W: 19.00" D: 19.75" Pwr: 115 VAC 400Hz																			
Description: The ASI-226 Interface Panel provides the interconnection between the various components of AN/ARN-139(V) Airborne TACAN System and the 972V-1 Test Set. The ASI-226 in conjunction with the 972V-1 and a TACAN Beacon Simulator will provide pre-installation testing and troubleshooting of the AN/ARN-139(V) System. Simulated in-flight condition can be duplicated to test performance and isolate faults of the system components to the module or card level. All cabling required to physically connect the ASI-226 to the 972V-1 is included as attached pendant cables extending from the front of Interface Panel. Alternate HSI cables for the 972V-1 are listed in the optional equipment section.		Optional Equipment: <table border="1" style="width: 100%; border-collapse: collapse;"> <thead> <tr> <th style="text-align: left;">ASI MN</th> <th style="text-align: left;">OEM PN</th> <th style="text-align: left;">Description</th> </tr> </thead> <tbody> <tr> <td>ASI-22-6A</td> <td>NPN</td> <td>Cable: 972V-1 to 331A-8H</td> </tr> <tr> <td>ASI-22-6B</td> <td>NPN</td> <td>Cable: 972V-1 to AQU-6/A</td> </tr> <tr> <td>ASI-22-6C</td> <td>NPN</td> <td>Cable: 972V-1 to 339D-1, ID-250, and ID-1347</td> </tr> <tr> <td>ASI-22-6D</td> <td>NPN</td> <td>Cable: 972V-1 to ID-1103 BDHI and ID-387</td> </tr> <tr> <td>ASI-8938-001</td> <td>618-8938-001</td> <td>Extender Board for 972V-1</td> </tr> </tbody> </table>	ASI MN	OEM PN	Description	ASI-22-6A	NPN	Cable: 972V-1 to 331A-8H	ASI-22-6B	NPN	Cable: 972V-1 to AQU-6/A	ASI-22-6C	NPN	Cable: 972V-1 to 339D-1, ID-250, and ID-1347	ASI-22-6D	NPN	Cable: 972V-1 to ID-1103 BDHI and ID-387	ASI-8938-001	618-8938-001	Extender Board for 972V-1
ASI MN	OEM PN	Description																		
ASI-22-6A	NPN	Cable: 972V-1 to 331A-8H																		
ASI-22-6B	NPN	Cable: 972V-1 to AQU-6/A																		
ASI-22-6C	NPN	Cable: 972V-1 to 339D-1, ID-250, and ID-1347																		
ASI-22-6D	NPN	Cable: 972V-1 to ID-1103 BDHI and ID-387																		
ASI-8938-001	618-8938-001	Extender Board for 972V-1																		
Equipment Supplied: <table border="1" style="width: 100%; border-collapse: collapse;"> <thead> <tr> <th style="text-align: left;">ASI MN</th> <th style="text-align: left;">OEM PN</th> <th style="text-align: left;">Description</th> </tr> </thead> <tbody> <tr> <td> </td> <td> </td> <td> </td> </tr> </tbody> </table>		ASI MN	OEM PN	Description																
ASI MN	OEM PN	Description																		

614E-10/10() Mode Sel Switch Adjustment Fixture ASI-229

OEM Equivalent: Collins MN: PN: Manual: 523-0759435 / 523-0769673 Manual Figure: 1004 / 903	UUT: 614E-10/-10() Size: H: 3.75" W: 5.00" D: 8.50" Pwr: N/A	Equipment Supplied: <table border="1" style="width: 100%; border-collapse: collapse;"> <thead> <tr> <th style="text-align: left;">ASI MN</th> <th style="text-align: left;">OEM PN</th> <th style="text-align: left;">Description</th> </tr> </thead> <tbody> <tr> <td> </td> <td> </td> <td> </td> </tr> </tbody> </table>	ASI MN	OEM PN	Description												
ASI MN	OEM PN	Description															
Description: The ASI-229 provides capability to align and adjust the MODE SEL switch in the Rockwell Collins 614E-10/-10() Flight Director Control.		Optional Equipment: <table border="1" style="width: 100%; border-collapse: collapse;"> <thead> <tr> <th style="text-align: left;">ASI MN</th> <th style="text-align: left;">OEM PN</th> <th style="text-align: left;">Description</th> </tr> </thead> <tbody> <tr> <td>ASI-40Y-13</td> <td>522-4962-001</td> <td>Plug in Adapter for 614E-7/8/9/10/11 (440Y-13)</td> </tr> <tr> <td>ASI-167</td> <td>522-3498-000</td> <td>Synchro Simulator (978F-2S)</td> </tr> <tr> <td>ASI-282</td> <td>622-0846-001</td> <td>Universal Flight Control Test Panel (980L-1A)</td> </tr> <tr> <td>ASI-377-7</td> <td>522-3423-001</td> <td>Mode Control Test Panel (978F-3M)</td> </tr> </tbody> </table>	ASI MN	OEM PN	Description	ASI-40Y-13	522-4962-001	Plug in Adapter for 614E-7/8/9/10/11 (440Y-13)	ASI-167	522-3498-000	Synchro Simulator (978F-2S)	ASI-282	622-0846-001	Universal Flight Control Test Panel (980L-1A)	ASI-377-7	522-3423-001	Mode Control Test Panel (978F-3M)
ASI MN	OEM PN	Description															
ASI-40Y-13	522-4962-001	Plug in Adapter for 614E-7/8/9/10/11 (440Y-13)															
ASI-167	522-3498-000	Synchro Simulator (978F-2S)															
ASI-282	622-0846-001	Universal Flight Control Test Panel (980L-1A)															
ASI-377-7	522-3423-001	Mode Control Test Panel (978F-3M)															

Indicator Test Set ASI-231-1

OEM Equivalent: Collins MN: 974G-1 PN: Manual: T.O.12R5-4-79-12 Manual Figure: 3-1	UUT: 339H-1/-1A/-1B Size: H: 7.00" W: 19.00" D: 8.00" Pwr: 115 VAC 400 Hz / +/- 30 VDC	Equipment Supplied: <table border="1" style="width: 100%; border-collapse: collapse;"> <thead> <tr> <th style="text-align: left;">ASI MN</th> <th style="text-align: left;">OEM PN</th> <th style="text-align: left;">Description</th> </tr> </thead> <tbody> <tr> <td>ASI-23-11A</td> <td>NPN</td> <td>Cable W1: ASI-231-1 to 339H-1()</td> </tr> <tr> <td>ASI-23-11B</td> <td>NPN</td> <td>Cable W2: ASI-231-1 Power</td> </tr> </tbody> </table>	ASI MN	OEM PN	Description	ASI-23-11A	NPN	Cable W1: ASI-231-1 to 339H-1()	ASI-23-11B	NPN	Cable W2: ASI-231-1 Power
ASI MN	OEM PN	Description									
ASI-23-11A	NPN	Cable W1: ASI-231-1 to 339H-1()									
ASI-23-11B	NPN	Cable W2: ASI-231-1 Power									
Description: The ASI-231-1 is used for testing and troubleshooting of the Collins 339H-1() Radio Altimeter Indicators. The ASI-231-1 replaces the ASI-231 and ASI-231R however the the ASI-164 may be a better option if testing the 339H-2/-5/-6 Indicators is also required.		Optional Equipment: <table border="1" style="width: 100%; border-collapse: collapse;"> <thead> <tr> <th style="text-align: left;">ASI MN</th> <th style="text-align: left;">OEM PN</th> <th style="text-align: left;">Description</th> </tr> </thead> <tbody> <tr> <td>ASI-164</td> <td>NPN</td> <td>Radio Altimeter Indicator Test Panel</td> </tr> <tr> <td>ASI-203</td> <td>522-4610-004</td> <td>Radio Altimeter Ramp Test Set</td> </tr> </tbody> </table>	ASI MN	OEM PN	Description	ASI-164	NPN	Radio Altimeter Indicator Test Panel	ASI-203	522-4610-004	Radio Altimeter Ramp Test Set
ASI MN	OEM PN	Description									
ASI-164	NPN	Radio Altimeter Indicator Test Panel									
ASI-203	522-4610-004	Radio Altimeter Ramp Test Set									

51Z-3/-4/-6 Test Fixture ASI-236

OEM Equivalent: Collins MN: PN: Manual: 523-0755843 / 523-0774982 Manual Figure: 1002 / 5-1	UUT: 51Z-3 / 51Z-4 / 51Z-6 Size: H: 3.50" W: 19.00" D: 8.00" Pwr: 28 VDC	Equipment Supplied: <table border="1" style="width: 100%; border-collapse: collapse;"> <thead> <tr> <th style="text-align: left;">ASI MN</th> <th style="text-align: left;">OEM PN</th> <th style="text-align: left;">Description</th> </tr> </thead> <tbody> <tr> <td>ASI-23-6A</td> <td>NPN</td> <td>Cable: ASI-236 to 51Z-3/-4</td> </tr> <tr> <td>ASI-23-6B</td> <td>NPN</td> <td>Cable: ASI-236 to 51Z-6</td> </tr> </tbody> </table>	ASI MN	OEM PN	Description	ASI-23-6A	NPN	Cable: ASI-236 to 51Z-3/-4	ASI-23-6B	NPN	Cable: ASI-236 to 51Z-6
ASI MN	OEM PN	Description									
ASI-23-6A	NPN	Cable: ASI-236 to 51Z-3/-4									
ASI-23-6B	NPN	Cable: ASI-236 to 51Z-6									
Description: The ASI-236 Test Fixture provides capability to test and troubleshoot the 51Z-3/-4/-6 Marker Beacon Receivers. The Test Fixture simulates in-aircraft installation with either single or dual indicators. Cables requires to interface the the ASI-236 to the 51Z-3/-4 and 51Z-6 are included.		Optional Equipment: <table border="1" style="width: 100%; border-collapse: collapse;"> <thead> <tr> <th style="text-align: left;">ASI MN</th> <th style="text-align: left;">OEM PN</th> <th style="text-align: left;">Description</th> </tr> </thead> <tbody> <tr> <td> </td> <td> </td> <td> </td> </tr> </tbody> </table>	ASI MN	OEM PN	Description						
ASI MN	OEM PN	Description									

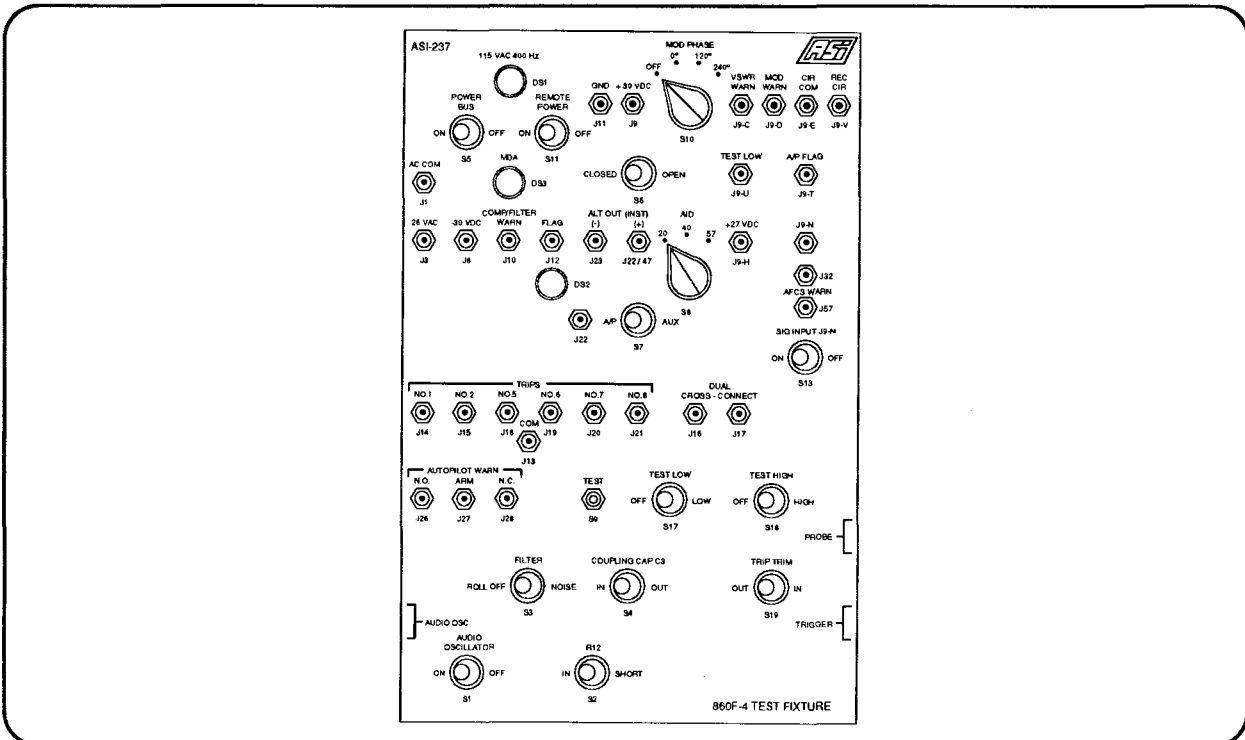

This unit is manufactured to replace the OEM model and/or part number listed below in form, fit, and function.

Equivalent OEM: Rockwell Collins

Equivalent MN:

Equivalent PN:

Manual Figure: 860F-1, Fig. 1002A - 1002E

860F-4, Fig. 902A - 906

Units Tested:

860F-1 Radio Altimeter

860F-4 Radio Altimeter

Description of Operation:

The ASI-237 is configured to provide interconnection between the Collins 860F-1/-4 Radio Altimeter and the test equipment required for testing and repair. Access to signals and outputs of the 860F-1/-4 is also provided. The ASI-237 includes all additional circuits suggested on the schematic diagram (Fig. 904 or 1002C).

The ASI-237 is also available in a 19" panel mount style (see ASI-194 for details)

The optional equipment required for testing the 860F-1/-4 is listed below (860F-1 manual figures are listed first, 860F-4 figures listed second)

Specifications:

Height: 8.00" Width: 12.00" Depth: 3.00"

Power: 115 VAC 400 Hz

Equipment Supplied:

ASI MN	Equivalent PN	Description
--------	---------------	-------------

Optional Equipment:

ASI MN	Equivalent PN	Description
ASI-194	NPN	Test Panel (19" standard) version of the ASI-237
ASI-238	NPN	Transmitter alignment tool (Fig. 1006A or 911)
ASI-239	635-6254-001	Special coaxial wrench
ASI-240	NPN	RF cable (paragraph 2 or 3)
ASI-719	NPN	Pulse Gen Test Box (860F-4 fig. 906)

Figure numbers correspond with 860F-1 (522-3698-002) manual and 860F-4 (622-3890-002) manual. Different part numbered versions of the 860F-1/-4 may have slightly different manual figure numbers.

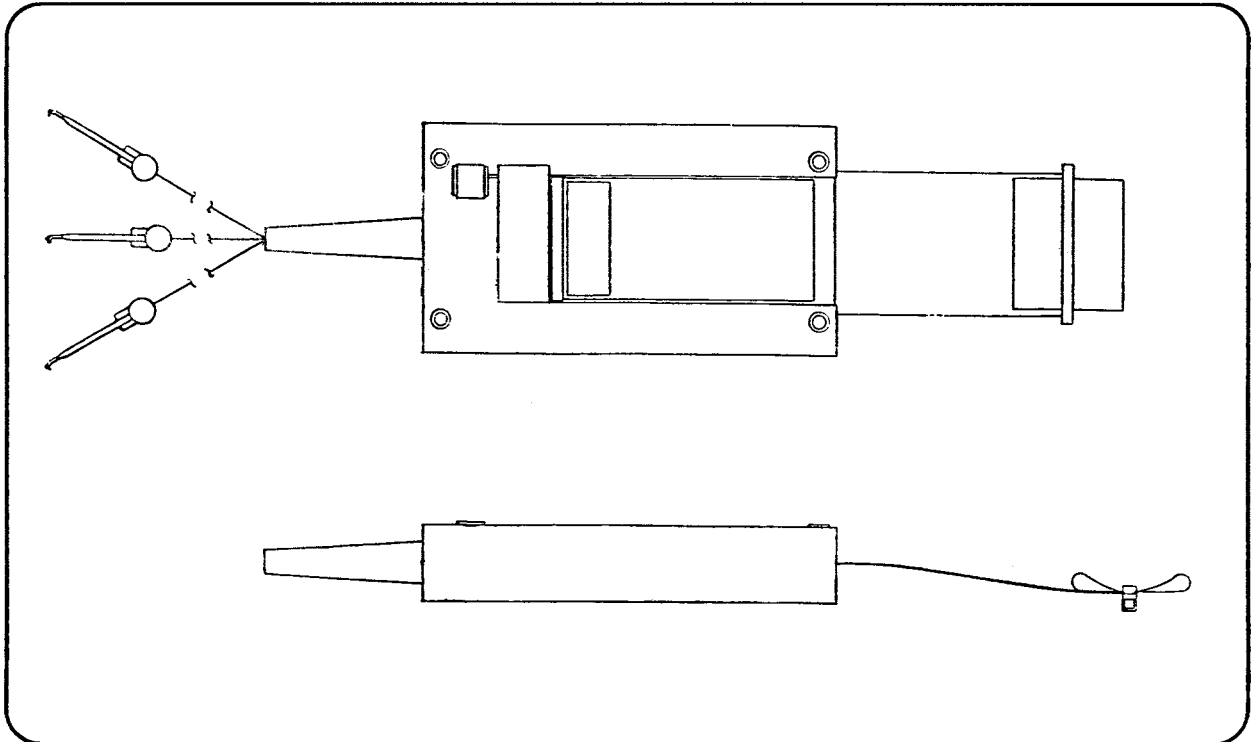

This unit is manufactured to replace the OEM model and/or part number listed below in form, fit, and function.

Equivalent OEM: Collins
 Equivalent MN: MST-901
 Equivalent PN: 622-6100-001
 Manual Figure:

Units Tested:
 860F-4 Radio Altimeter
 Altitude Processor card A4
 Monitor Processor card A6

Description of Operation:

The ASI-241 Microprocessor Test Adapter provides isolation and interconnection between the Fluke 9000A-8080 pod and the 860F-4 altitude processor A4 or monitor processor A6 board for the purpose of testing and troubleshooting. A pre-programmed software cassette cpn 647-9767-002 is necessary but not supplied; it must be purchased directly from Collins.

Specifications:

Height: 7.25" Width: 4.00" Depth: 1.50" Power: None required

Equipment Supplied:

ASI MN	Equivalent PN	Description
--------	---------------	-------------

Optional Equipment:

ASI MN	Equivalent PN	Description
	647-9767-002	Software Cassette

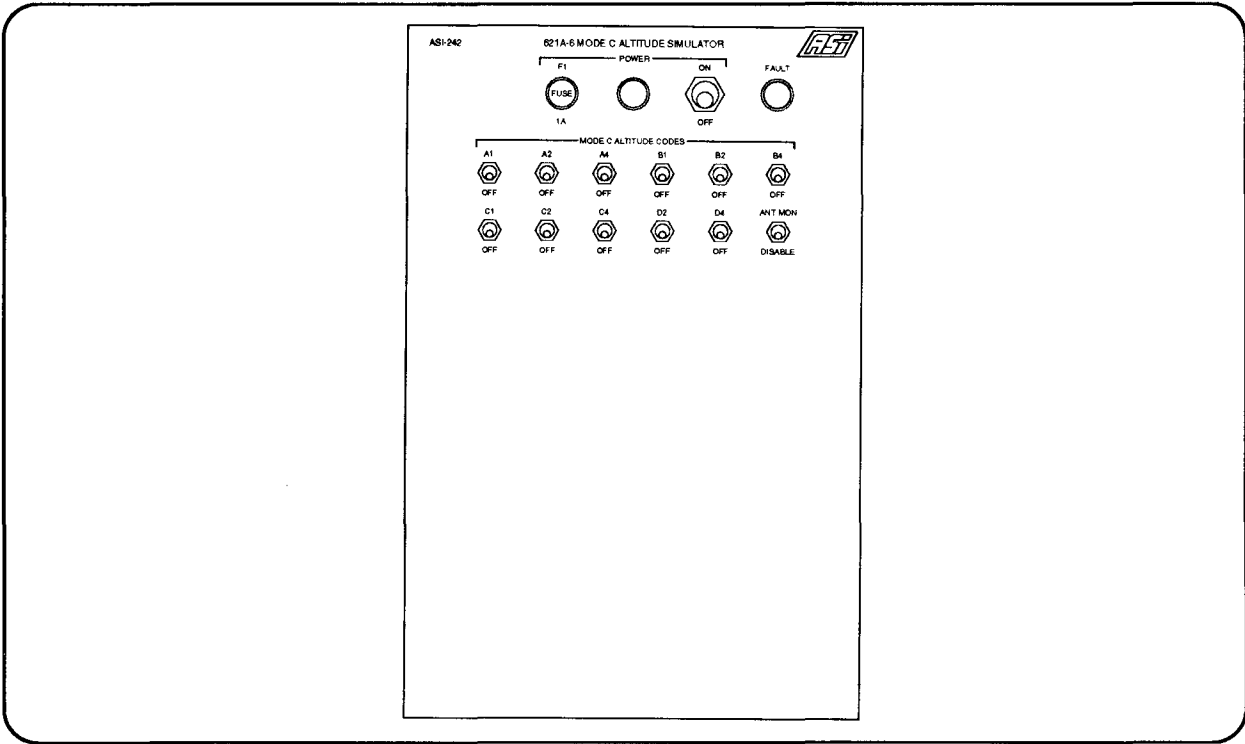

This unit is manufactured to replace the OEM model and/or part number listed below in form, fit, and function.

Equivalent OEM: Collins

Units Tested:

Equivalent MN:

621A-6/6A Transponder

Equivalent PN:

Manual Figure: 621A-6/6A, Fig. 1003

Description of Operation:

The ASI-242 Test Fixture is used for the testing, alignment, and troubleshooting of the Collins 621A-6/6A Transponder. The Test Fixture is wired for a Gables G-3223 or equivalent ARINC control head (not supplied). Features of the ASI-242 include Mode C altitude simulation, a fault lamp, and antenna monitor disable switch.

Specifications:

Height: 12.00" Width: 8.00" Depth: 3.00"

Power: 115 VAC 400 HZ

Equipment Supplied:

ASI MN	Equivalent PN	Description
--------	---------------	-------------

Optional Equipment:

ASI MN	Equivalent PN	Description
--------	---------------	-------------

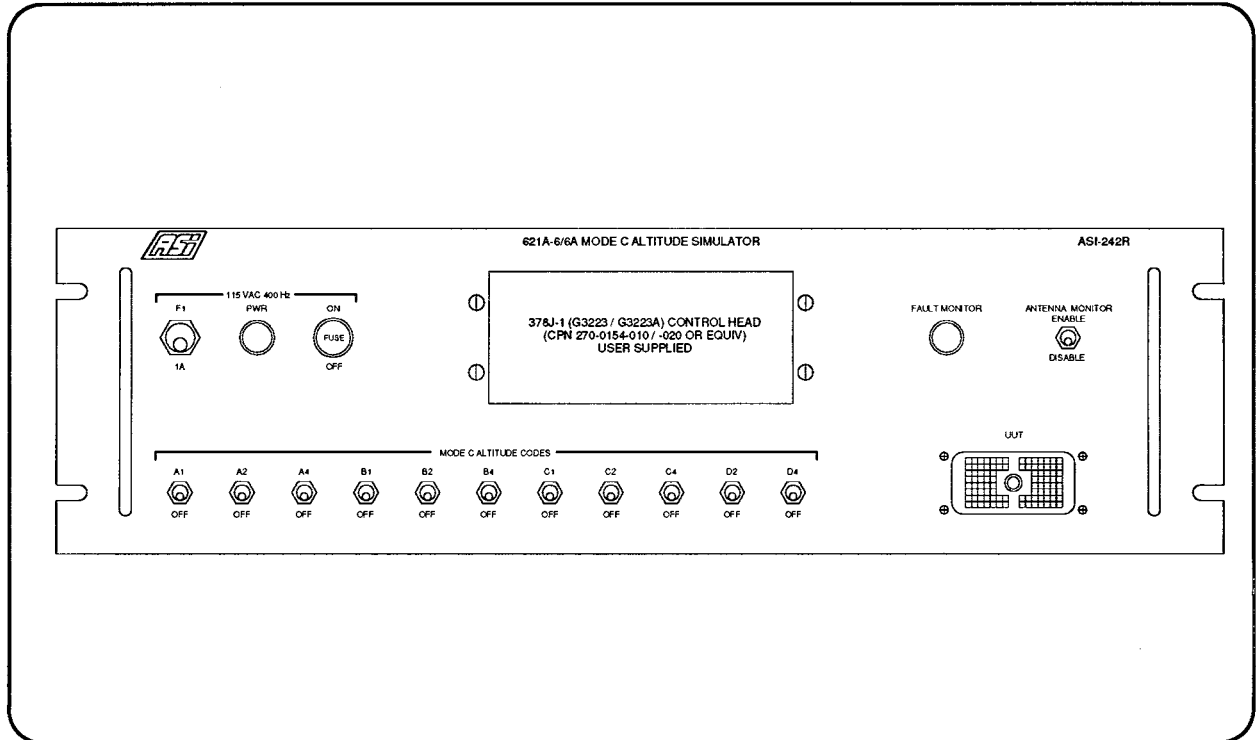

This unit is manufactured to replace the OEM model and/or part number listed below in form, fit, and function.

Equivalent OEM: Collins

Equivalent MN:

Equivalent PN:

Manual Figure: 621A-6/6A Fig. 1003, 621A-3 Fig. 1004

Units Tested:

621A-6/6A Transponder

621A-3 (requires optional cable)

Description of Operation:

The ASI-242R Test Fixture is used for the testing, alignment, and troubleshooting of the Collins 621A-6/6A Transponder. The test panel requires a user supplied ARINC control head (378J-1 cpn 270-0154-010/-020 or Gables G3223/G3223A) for proper operation. The ASI-242R includes Mode C altitude simulation, fault lamp, and antenna monitor disable switch.

The ASI-242R comes complete with test cable for the 621A-6/6A (ASI-24-2A). The cable required for testing the Collins 621A-3 (ASI-24-2B) is optional.

Specifications:

Height: 5.25" Width: 19.00" Depth: 8.00"

Power: 115 VAC 400 Hz

Equipment Supplied:

ASI MN	Equivalent PN	Description
ASI-24-2A		Test Cable: ASI-242R to 621A-6/6A

Optional Equipment:

ASI MN	Equivalent PN	Description
ASI-24-2B		Test Cable: ASI-242R to 621A-3
ASI-24-2C		IF Alignment Cover (621A-6 Man Fig. 1002)

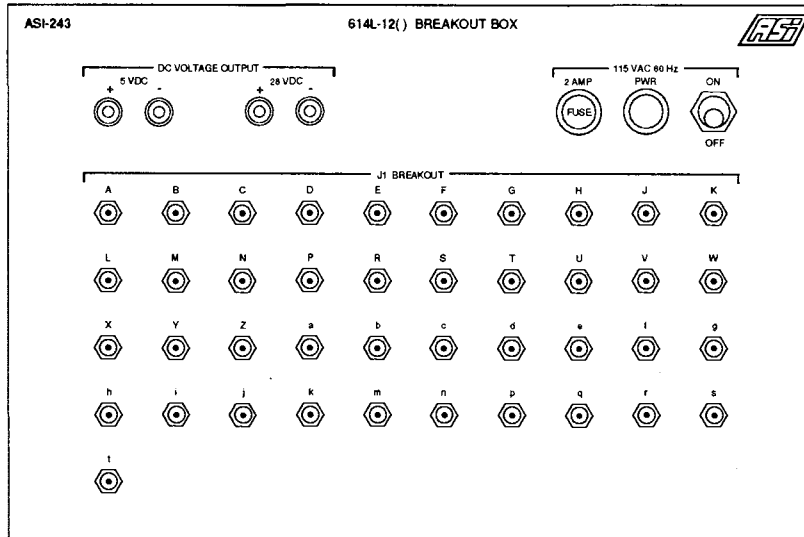

This unit is manufactured to replace the OEM model and/or part number listed below in form, fit, and function.

Equivalent OEM: Rockwell Collins
 Equivalent MN:
 Equivalent PN:
 Manual Figure:

Units Tested:
 614L-12 ADF Control Unit

Description of Operation:

The ASI-243 Breakout Box is a test fixture configured to facilitate the testing and repair of Collins 614L-12 ADF Control Units. Each pin of the 614L-12 rear connector is accessible on the ASI-243; this allows easy continuity testing as called for in the testing procedure. 5VDC and 28VDC power supplies for testing panel lighting are also included in the ASI-243.

Specifications:

Height: 12.00" Width: 8.00" Depth: 3.00" Power: 115 VAC 60 Hz

Equipment Supplied:

ASI MN	Equivalent PN	Description
--------	---------------	-------------

Optional Equipment:

ASI MN	Equivalent PN	Description
--------	---------------	-------------

PPI-1TB Radar Indicator Test Panel

ASI-244-1

OEM Equivalent:

OEM: Bendix
 Model Number: PPT-1FB
 Part Number: 2041350-0101
 Manual: I.B. 1103BT-1 / 34-43-09
 Manual Figure: 1

This unit is manufactured to replace the OEM MN, PN, and/or manual figure listed in Form, Fit, and Function.

Description:

The ASI-244-1 Radar Indicator Test Panel facilitates testing, alignment, and troubleshooting of the Bendix PPI-1TB Weather Radar Indicator and CON-1FB SKE Range Selector.

The Test Panel contains a power supply, video generator, pattern generator, color generator, and azimuth circuitry, thus eliminating the need for other system components during testing of the PPI-1TB Radar Indicator.

The ASI-244-1 includes the PPI-1TB interconnect cable (ASI-24-4A) and the CON-1FB Test Adapter (ASI-244-3).

Test panels designed to test other units of the RDR-1FB Weather Radar System are also available from Avionics Specialist, Inc. These test panels are listed in the optional equipment section below.

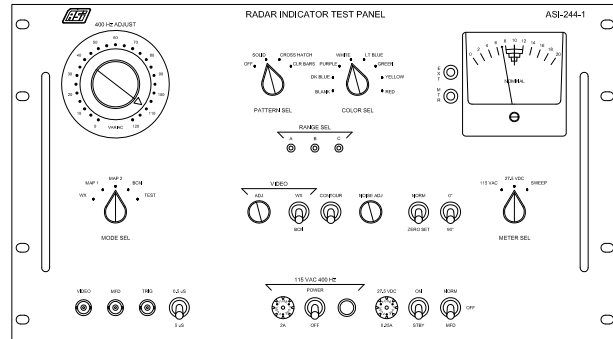

Units Tested:

PPI-1TB
 CON-1FB

Specifications:

Height: 10.50" Width: 19.00" Depth: 17.00"
 Power Requirements: 115 VAC 400 Hz

Equipment Supplied:

ASI MN	OEM PN	Description
ASI-24-4A	2039608-0501	Cable, ASI-244-1 to PPI-1TB (W101)
ASI-244-3	2039817-0501	CON-1FB Test Adapter (W102)

Optional Equipment:

ASI MN	OEM PN	Description
ASI-152-2	2041351-0102	RDR-1FB Radar Test Panel (RDT-1FB)
ASI-153-2	2038270-0502	ANT-1TB Radar Antenna Test Panel (ATT-1FB)
ASI-154-2	2041349-0102	RDR-1FB Radar System Test Panel (RCT-1FB)

PPI-1TB(M) Radar Indicator Test Panel

ASI-244-2

OEM Equivalent:

OEM: Bendix
 Model Number: PPT-1FB
 Part Number: 2041350-0102
 Manual: I.B. 1103BT-1 / 34-43-09
 Manual Figure: 1

This unit is manufactured to replace the OEM MN, PN, and/or manual figure listed in Form, Fit, and Function.

Description:

The ASI-244-2 Radar Indicator Test Panel facilitates testing, alignment, and troubleshooting of the Bendix PPI-1TB(M) Weather Radar Indicator and CON-1TB(M) Ant Azimuth Control.

The Test Panel contains a power supply, video generator, pattern generator, color generator, and azimuth circuitry, thus eliminating the need for other system components during testing of the PPI-1TB(M) Radar Indicator. The ASI-244-2 also contains an azimuth motor drive board which simulates the ANT-1TB(M) sector scan antenna movement. This added circuitry, in conjunction with the ASI-244-4 Test Adapter, allows testing of the CON-1TB(M) Antenna Azimuth Control.

The ASI-244-2 includes the PPI-1TB(M) interconnect cable (ASI-24-42A), CON-1TB(M) Test Adapter (ASI-244-4) and cable (ASI-24-42B).

Test panels designed to test other units of the RDR-1FB(M) Weather Radar System are also available from Avionics Specialist, Inc. These test panels are listed in the optional equipment section below.

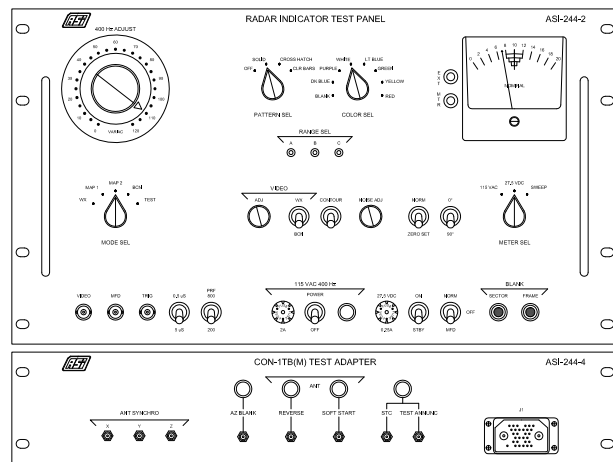

Units Tested:

PPI-1TB CON-1TB(M)
 PPI-1TB(M)

Specifications:

Height: 10.50" Width: 19.00" Depth: 17.00"
 Power Requirements: 115 VAC 400 Hz

Equipment Supplied:

ASI MN	OEM PN	Description
ASI-24-42A	2039608-0502	Cable, ASI-244-2 to PPI-1TB(M) (W101)
ASI-24-42B	8056285-0501	Cable, ASI-244-4 to CON-1TB(M) (W101)
ASI-244-4	8050799-0501	CON-1TB(M) Test Adapter

Optional Equipment:

ASI MN	OEM PN	Description
ASI-152-2	2041351-0102	RDR-1FB Radar Test Panel (RDT-1FB)
ASI-153-3	2038270-0503	ANT-1TB Radar Antenna Test Panel (ATT-1FB)
ASI-154-2	2041349-0102	RDR-1FB Radar System Test Panel (RCT-1FB)

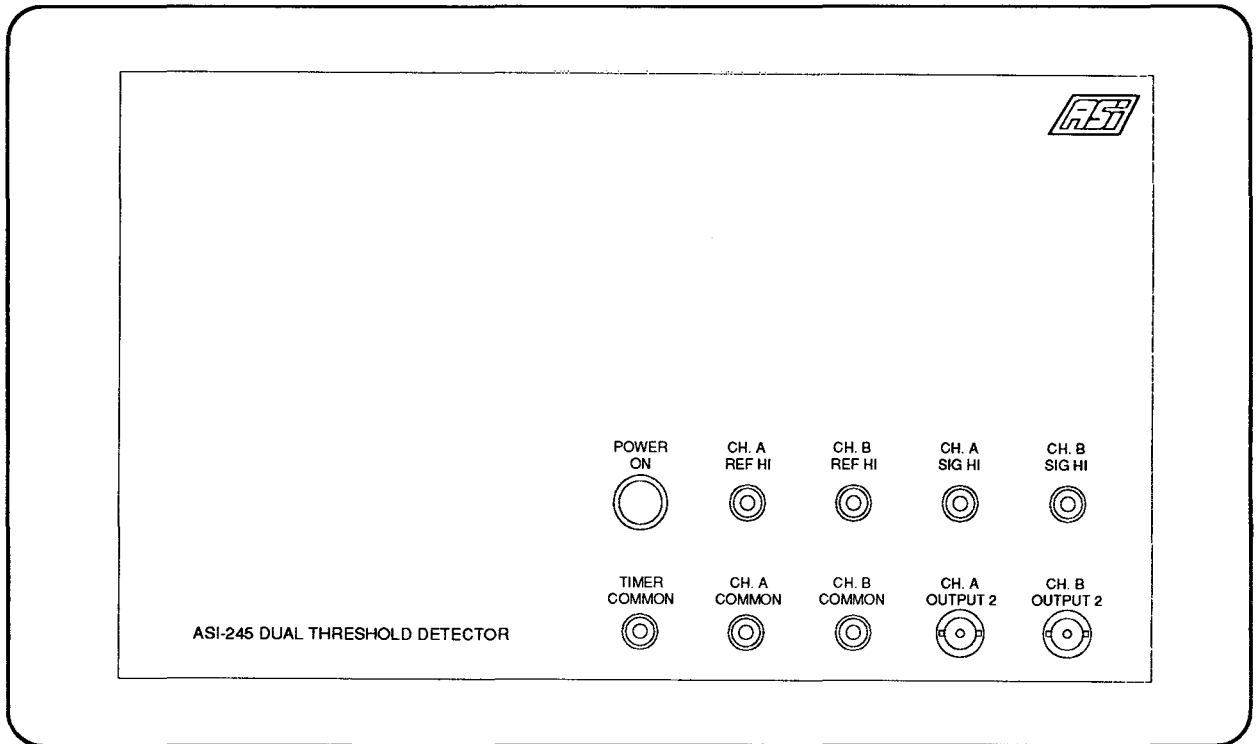

This unit is manufactured to replace the OEM model and/or part number listed below in form, fit, and function.

Equivalent OEM: Collins

Equivalent MN: 700D-2A

Equivalent PN: 622-0147-001

Manual Figure: 971T-1, Overhaul Section Fig. 17

Units Tested:

971T-1 Test Set

Description of Operation:

The ASI-245 Dual Threshold Detector is utilized during the calibration and testing of the Collins 971T-1 Test Set. In conjunction with a timer as shown in the manual (Overhaul Section, Fig. 7), it allows the precise timing of the slew rates of the rate generators within the 971T-1.

Specifications:

Height: 7.00" Width: 12.00" Depth: 3.00"

Power: 115 VAC 60 Hz

Equipment Supplied:

ASI MN	Equivalent PN	Description
--------	---------------	-------------

Optional Equipment:

ASI MN	Equivalent PN	Description
--------	---------------	-------------

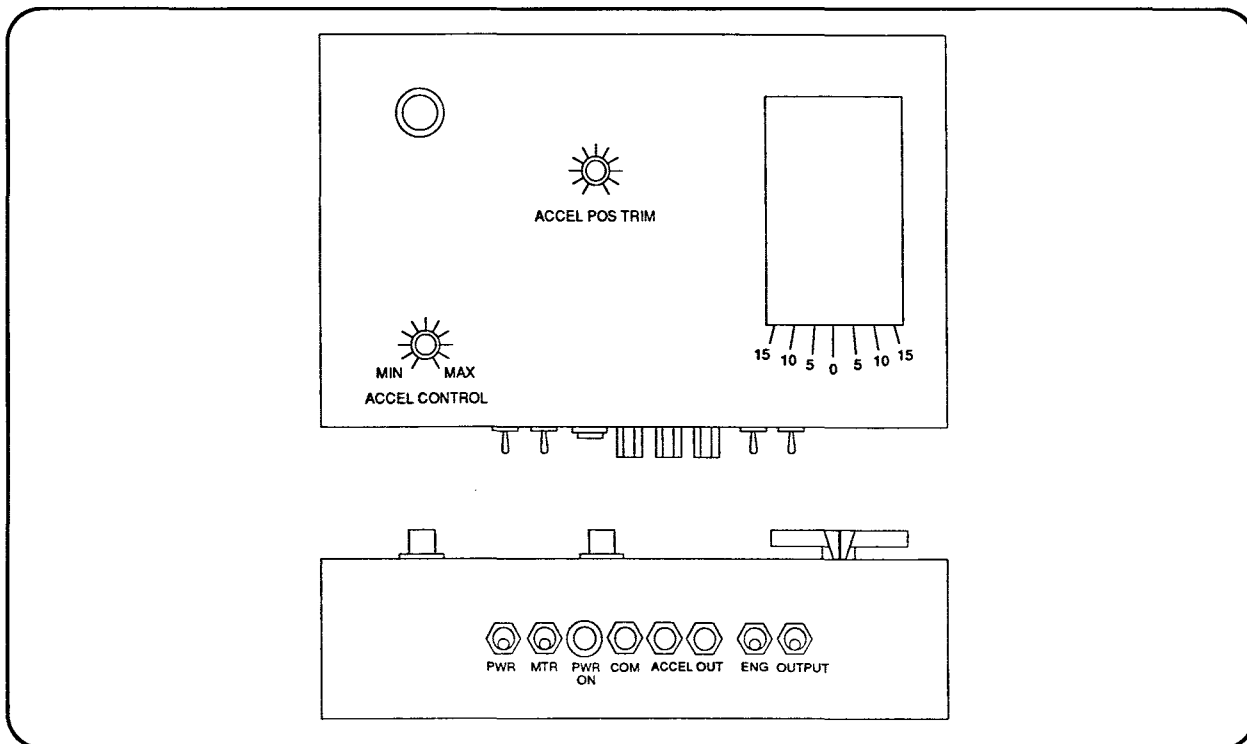

This unit is manufactured to replace the OEM model and/or part number listed below in form, fit, and function.

Equivalent OEM: Collins

Equivalent MN:

Equivalent PN: 634-0549-001

Manual Figure: 562C-8F/8G, Yaw Damper
Test Fixture Appendix

Units Tested:

562C-8() Yaw Damper Computer

A2A1 Angular Accelerometer

Description of Operation:

The ASI-247 tests the angular accelerometer (A2A1) in the Collins 562C-8() Yaw Damper Computer. The Test Fixture features a platform to which the accelerometer or Yaw Damper Computer is secured. A motor applies an adjustable angular acceleration, and the resulting output can be measured.

Specifications:

Height: 8.00" Width: 12.00" Depth: 3.00"

Power: 28 VDC

Equipment Supplied:

ASI MN	Equivalent PN	Description
--------	---------------	-------------

Optional Equipment:

ASI MN	Equivalent PN	Description
--------	---------------	-------------

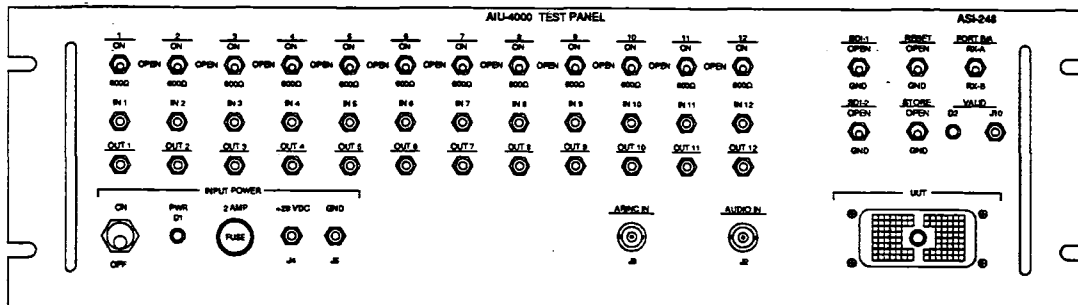

This unit is manufactured to replace the OEM model and/or part number listed below in form, fit, and function.

Equivalent OEM: Collins
 Equivalent MN:
 Equivalent PN:
 Manual Figure:

Units Tested:
 AIU-4000

Description of Operation:

The ASI-248 supplies power, input/output signals, and interface required to test the Collins AIU-4000.

An interface cable (ASI-24-8A) is supplied with the test panel.

Specifications:

Height: 5.25" Width: 19.00" Depth: 6.00"

Power: 28 VDC

Equipment Supplied:

ASI MN	Equivalent PN	Description
ASI-24-8A		Cable: ASI-248 to Collins AIU-4000

Optional Equipment:

ASI MN	Equivalent PN	Description
--------	---------------	-------------

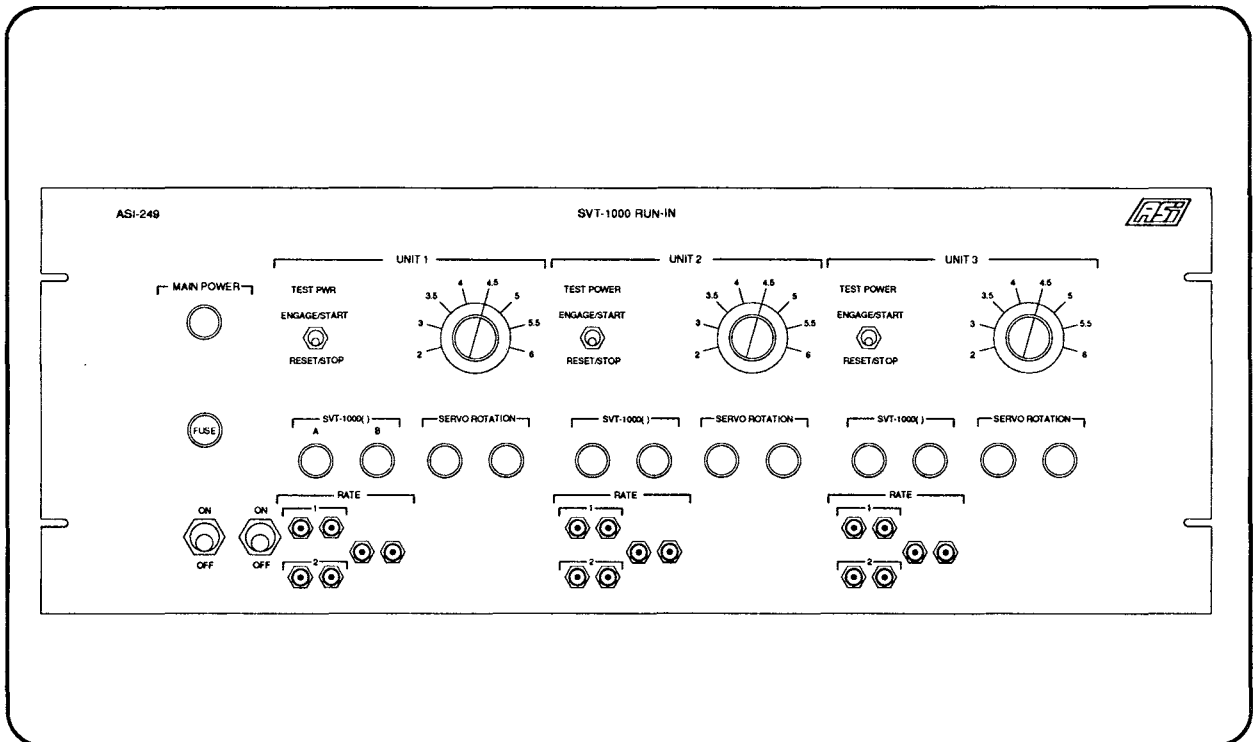

This unit is manufactured to replace the OEM model and/or part number listed below in form, fit, and function.

Equivalent OEM: Collins
 Equivalent MN:
 Equivalent PN: 676-1949-001
 Manual Figure:

Units Tested:
 SVT-1000 Servo

Description of Operation:

The ASI-249 is used for the run-in and testing of the SVT-1000 Servo. Testing/run-in periods are selectable from 2 to 6 hours. Up to 3 units can be tested simultaneously using the 3 ASI-24-9A cables included with the Test Panel.

Specifications:

Height: 7.00" Width: 19.00" Depth: 12.00" Power: 115 VAC 60 Hz

Equipment Supplied:

ASI MN	Equivalent PN	Description
ASI-24-9A	676-1949-011	Cable: ASI-249 to Collins SVT-1000 (3 supplied)

Optional Equipment:

ASI MN	Equivalent PN	Description
--------	---------------	-------------

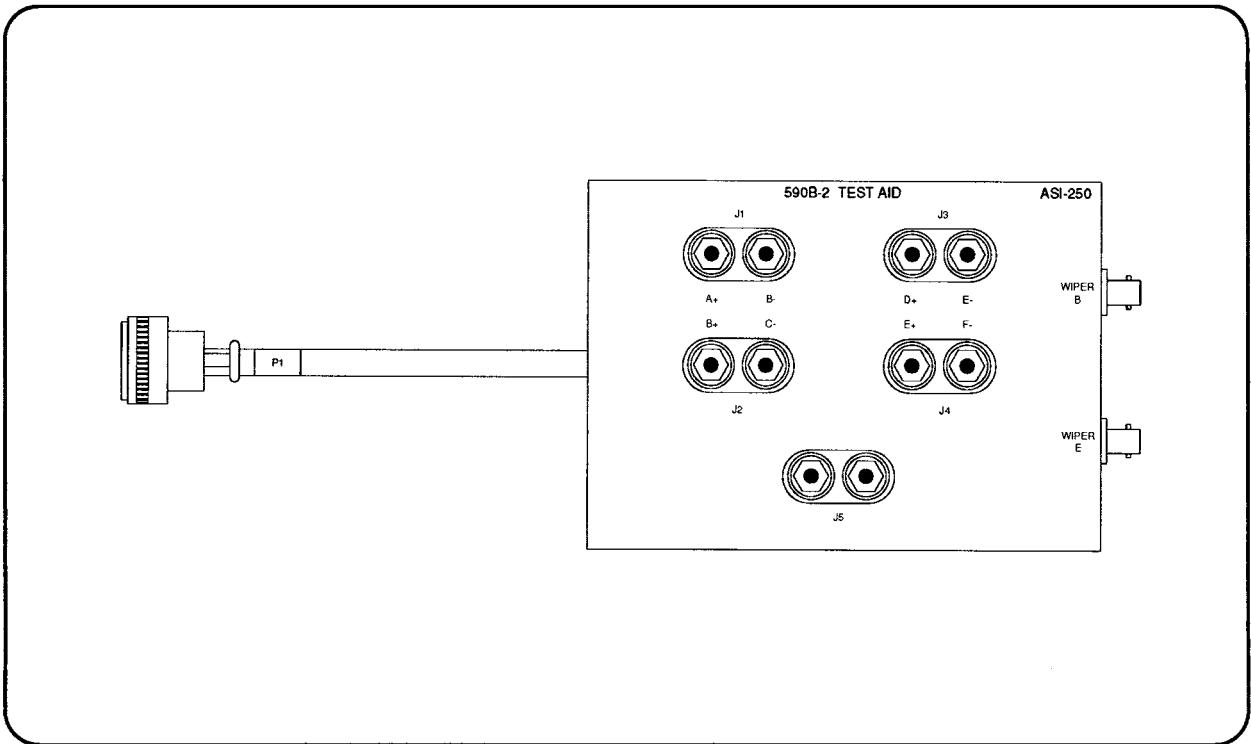

This unit is manufactured to replace the OEM model and/or part number listed below in form, fit, and function.

Equivalent OEM: Collins
 Equivalent MN:
 Equivalent PN: 685-6220-001
 Manual Figure:

Units Tested:
 590B-2 Airspeed Sensor

Description of Operation:

The ASI-250 Test Aid provides breakout and test points required when testing the Collins 590B-2 Airspeed Sensor.

Specifications:

Height: 5.00" Width: 7.00" Depth: 2.00"

Equipment Supplied:

ASI MN	Equivalent PN	Description
--------	---------------	-------------

Optional Equipment:

ASI MN	Equivalent PN	Description
--------	---------------	-------------

Radar Control Test Panel

ASI-252-1

OEM Equivalent:

OEM: Bendix
 Model Number: COT-1FB
 Part Number: 2041348-0102
 Manual: I.B. 1103DT-1 / 34-43-11
 Manual Figure: 1

This unit is manufactured to replace the OEM MN, PN, and/or manual figure listed in Form, Fit, and Function.

Description:

The ASI-252-1 Radar Control Test Panel functions to test and troubleshoot Bendix CON-1RB/SB Radar Controls. The test panel also has functions required to test the CON-1RB(M) / CON-1SB(M) which have variable STC capability.

The Test Panel supplies the radar control with voltages required for function tests and provides a visual continuity check verifying the correct operation of the control's switches, controls, and wiring.

The ASI-252-1 includes a control test cable (ASI-15-2A) and test panel power cable (ASI-25-2B).

Test panels designed to test other units of the RDR-1FB Weather Radar System are listed in the optional equipment section below.

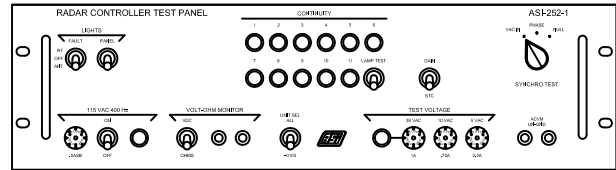

Units Tested:

CON-1RB CON-1SB
 CON-1RB(M) CON-1SB(M)

Specifications:

Height: 5.25" Width: 19.00" Depth: 12.00"
 Power Requirements: 115 VAC 400 Hz

Equipment Supplied:

ASI MN	OEM PN	Description
ASI-25-2A	2041579-0502	Cable, ASI-252-1 to CON-1 (W102)
ASI-25-2B	2041580-0501	Cable, ASI-252-1 Power (W102)

Optional Equipment:

ASI MN	OEM PN	Description
ASI-152-2	2041351-0102	RDR-1FB Radar Test Panel (RDT-1FB)
ASI-153-2	2038270-0502	ANT-1TB Radar Ant Test Panel (ATT-1FB)
ASI-154-2	2041349-0102	RDR-1FB Radar System Test Panel (RCT-1FB)
ASI-244-2	2041350-0102	PPI-1TB Radar Indicator Test Panel (PPT-1FB)

Radar Control Test Panel

ASI-252-2

OEM Equivalent:

OEM: Bendix
 Model Number: COT-4A
 Part Number: 2041593-0401
 Manual: I.B. 1104ET / 34-41-59
 Manual Figure: 1

This unit is manufactured to replace the OEM MN, PN, and/or manual figure listed in Form, Fit, and Function.

Description:

The ASI-252-2 Radar Control Test Panel provides the functions and capabilities necessary to test the Bendix CON-4A/B Radar Control separated from its operational environment. The test panel receives and decodes ARINC 429 control data and provides power to the CON-4() under test. The test panel thus substitutes its functions for those of the R/T, providing a surrogate operational environment.

The ASI-252-2 receives and decodes ARINC 429 control words 1 and 2 from the CON-4() and displays the decoded data on the front panel seven segment displays and LED's.

The ASI-252-2 includes two cables required for proper operation.

Test panels designed to test other units of the RDR-4A Weather Radar System are also available from Avionics Specialist, Inc. These test panels are listed in the optional equipment section below.

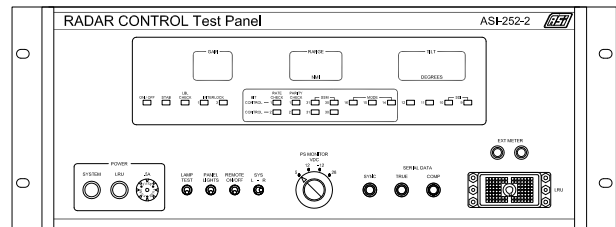

Units Tested:

CON-4A
 CON-4B

Specifications:

Height: 7.00" Width: 19.00" Depth: 13.00"
 Power Requirements: 115 VAC 400 Hz

Equipment Supplied:

ASI MN	OEM PN	Description
ASI-25-22A	2040035-0501	Cable, ASI-252-2 to CON-4A/B (W1)
ASI-25-22B	2040020-0501	Cable, ASI-252-2 Power (W8)

Optional Equipment:

ASI MN	OEM PN	Description
ASI-25-22C	NPN	Cable, ASI-252-2 to IFR STD-7000
ASI-169-2	2041797-0401	RDR-4A Portable Radar Test Set (RST-4A)
ASI-742	2041589-0401	RDR-4A Radar System Test Panel (RCT-4A)
ASI-760	2041591-0401	PPI-4B Radar Indicator Test panel (PPT-4A)
ASI-771	2041592-0401	DAA-4A/B Radar Antenna Test Panel (ATT-4A)

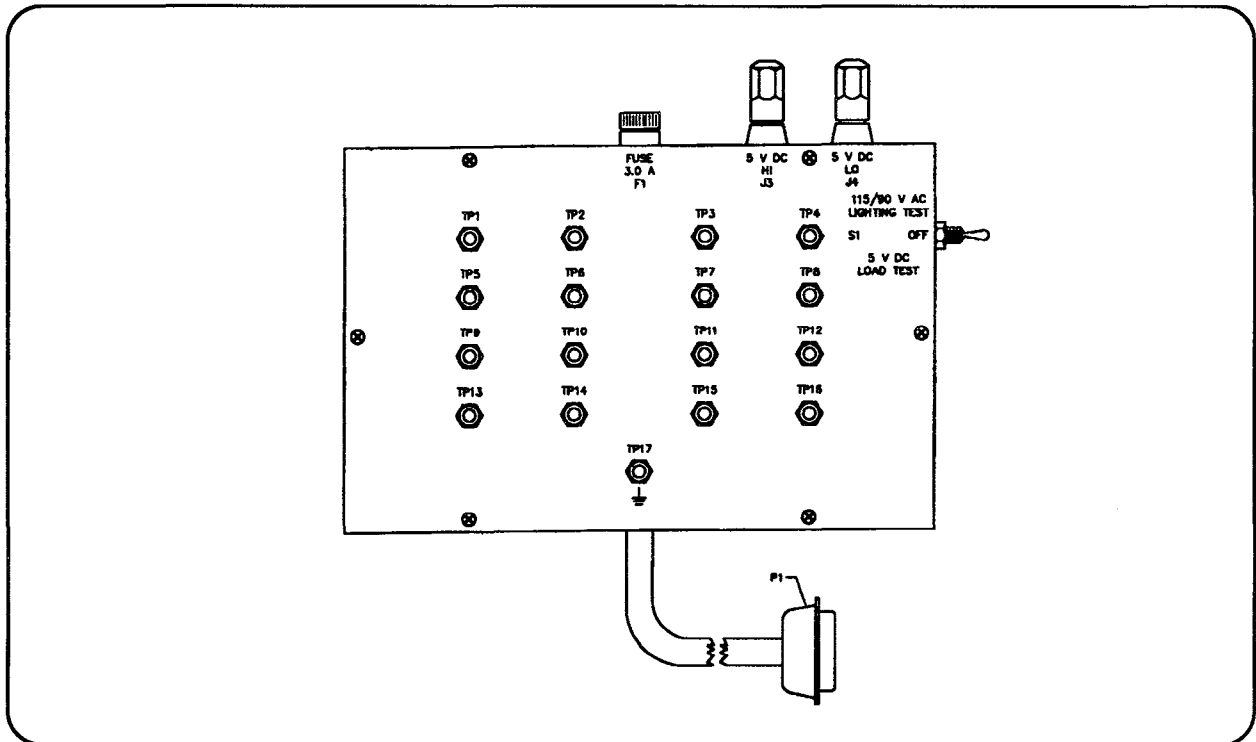

This unit is manufactured to replace the OEM model and/or part number listed below in form, fit, and function.

Equivalent OEM: Collins

Equivalent MN:

Equivalent PN:

Manual Figure: CHP-850() Fig. 901 - 902

Units Tested:

CHP-850() Course Heading Panel

Description of Operation:

The ASI-254 Test Set provides power, test points, and switching required for testing the Collins CHP-850().

Specifications:

Height: 2.00" Width: 6.00" Depth: 4.00"

Power: 115 VAC 400 Hz

Equipment Supplied:

ASI MN	Equivalent PN	Description
--------	---------------	-------------

Optional Equipment:

ASI MN	Equivalent PN	Description
--------	---------------	-------------

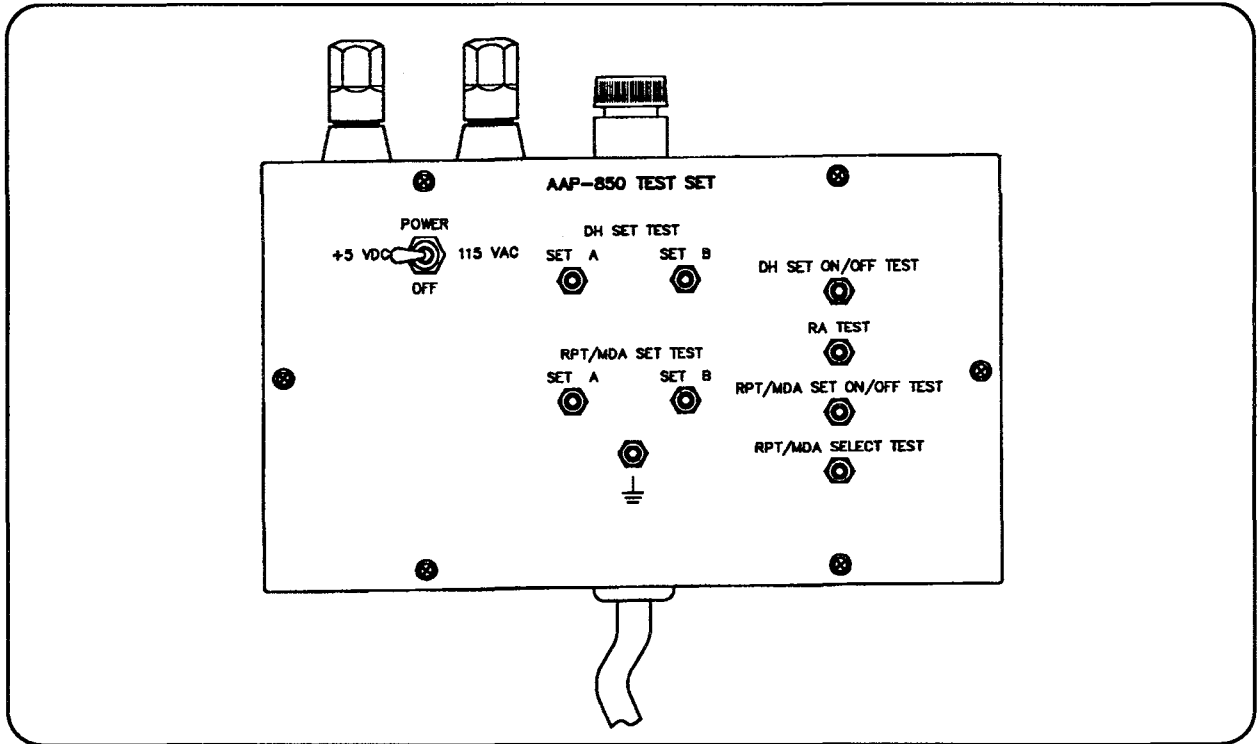

This unit is manufactured to replace the OEM model and/or part number listed below in form, fit, and function.

Equivalent OEM: Collins

Units Tested:

Equivalent MN:

AAP-850 Altitude Awareness Panel

Equivalent PN:

Manual Figure: AAP-850 Fig. 901 - 902

Description of Operation:

The ASI-255 Test Set provides power, test points, and switching required for testing the Collins AAP-850.

Specifications:

Height: 2.00" Width: 6.00" Depth: 4.00"

Power: 115 VAC 400 Hz

Equipment Supplied:

ASI MN	Equivalent PN	Description

Optional Equipment:

ASI MN	Equivalent PN	Description

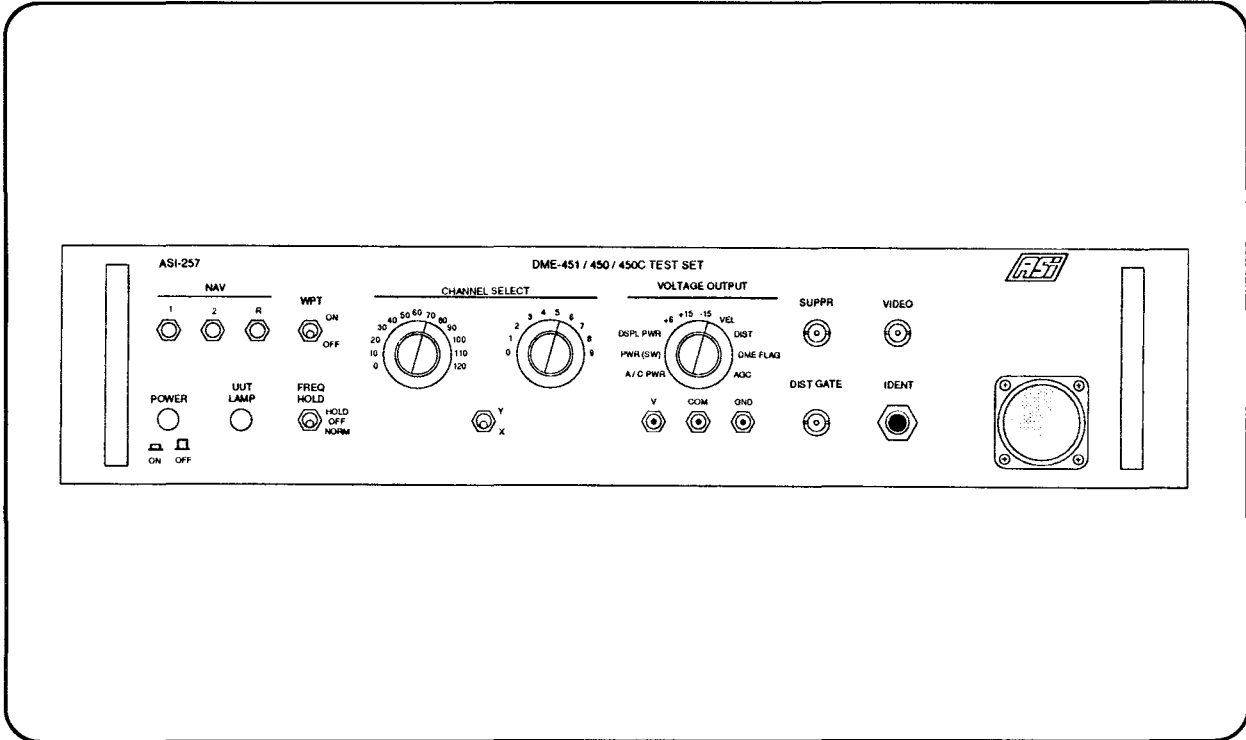

This unit is manufactured to replace the OEM model and/or part number listed below in form, fit, and function.

Equivalent OEM: Collins

Equivalent MN: CTS-451

Equivalent PN: 622-3882-001

Manual Figure: DME-451, Fig. 5-7 through 5-10

Units Tested:

DME-451/450/450C DME Systems

Description of Operation:

The ASI-257 is used for the testing and troubleshooting of the DME-451 System. It provides DME channel selection, X/Y mode, frequency hold, selected NAV annunciation, and RNAV mode selection. It also outputs selected voltages, and suppressor, video, distance gate, and ident signals. The ASI-25-7A cable provided with the Test Set interconnects the TCR-451 DME Transceiver, the IND-451/450/450C Indicator, and the ASI-257.

Specifications:

Height: 4.00" Width: 19.00" Depth: 6.00"

Power: 14 or 28 VDC

Equipment Supplied:

ASI MN	Equivalent PN	Description
ASI-25-7A		Cable: ASI-257 to DME-451 system

Optional Equipment:

ASI MN	Equivalent PN	Description
--------	---------------	-------------

TARSYN/VG-14 Final Test Fixture

ASI-260-1

OEM Equivalent:

OEM: Sperry
 Model Number:
 Part Number: T321703
 Manual: 31-3000-01
 Manual Figure: 1-11

This unit is manufactured to replace the OEM MN, PN, and/or manual figure listed in Form, Fit, and Function.

Description:

The ASI-260-1 Final Test Fixture provides power, loads, signals (except heading signals) and readouts required to test and calibrate the Sperry VG-14() Vertical Gyros and TARSYN() Three Axis References. Heading signals are supplied by an external flux valve simulator.

The ASI-260-1 includes three test cables. Three user supplied API's (NAI 8500 or equivalent) are required for proper operation.

Optional Equipment:

ASI MN	OEM PN	Description (Manual 31-3000-01 Figure)
ASI-27-5C1	T3012061-A	Rotor Clamp A (2-42)
ASI-27-5C2	T3012061-B	Rotor Clamp B (2-42)
ASI-27-5F	T3075022	Bearing Checking Tool (2-52)
ASI-27-5H	T896500	Bearing Preload Adapter Set (2-15)
ASI-27-5I	T891970	Bearing Preload Fixture (2-6)
ASI-27-5K	T896276	Rotor Balancing Cradle (2-8)
ASI-27-5L	T897024	Terminal Inserter (2-19)
ASI-26-01D	T321677	Indexing Turntable (1-9)
ASI-26-01E	T321686	VG-401 Holding Fixture (1-10)
ASI-26-01F	T3012055	Holding Fixture (2-41)
ASI-26-01G	T3012067	Slipring Guard (2-46)
ASI-26-01H	T893165	Brush Guard (2-7)
ASI-26-01J	T3012074	Hemisphere Aligning Fixture (2-47)
ASI-26-01K	T3012040	Synchro Alignment Block (2-36)
ASI-26-01L	T3012026	Synchro Cementing Fixture (2-33)
ASI-26-01M	T3012027	Slipring Alignment Fixture (2-34)
ASI-26-01N	T3012029	Slipring Alignment Tool (2-35)
ASI-26-01P	T3012050	Rotor Shimming Fixture (2-38)
ASI-26-01Q	T3013063	Brake Shimming Fixture (2-44)
ASI-26-01R	T3012066	Rotor Assembly Bushing (2-45)
ASI-26-01S	T3012062	Anvil (2-43)
ASI-26-01T	T3012469	Adapter Set (2-48)
ASI-26-01U	T675344	Torque Nut Driver (2-4)
ASI-26-01V	T3009296	Offset Wrench (2-31)
ASI-26-01W	T3012054	Rotor Balance Adapter Set (2-40)
ASI-26-01X	T674655	Static Balance Fixture (2-3)
ASI-26-01Y	T3017560	Balance Weight (2-51)
ASI-26-01Z	T3012042	Alignment Plate (2-37)
ASI-26-02D	T897177	Run-Out Fixture (2-21)
ASI-26-02E	T3012051	Gimbal Shimming Step Plug (2-39)
ASI-26-02F	T3000626	Holding Block (2-27)
ASI-26-02G	T898656	Dial Indicator Post (2-26)
ASI-26-02H	T626912	Gimbal balancing Fixture (2-2)
ASI-26-02J	T3013271	Spacer Block (2-50)
ASI-26-02K	T322896	Base Holding Fixture (1-20)
ASI-26-02L	T322710	Nut Cover Tightening Tool (2-1)
ASI-407-2	T321272-901	API Latching Fixture
ASI-411-1	T322695	VG-401 Test Fixture
ASI-411-2	T322880	TARSYN-H/VG-14H Base Test Fixture

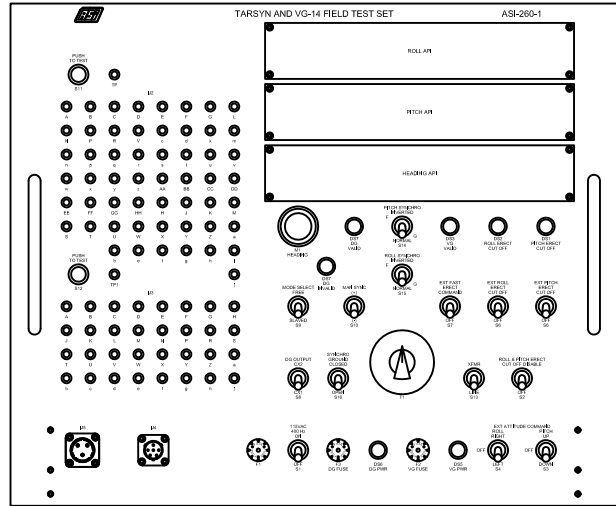

Units Tested:

VG-14	VG-14H	TARSYN
VG-14A	VG-401	TARSYN-H

Specifications:

Height: 15.75" Width: 19.00" Depth: 7.00"
 Power Requirements: 115 VAC 400 Hz

Equipment Supplied:

ASI MN	OEM PN	Description
ASI-26-01A	T321703-49	Cable, W1
ASI-26-01B	T321703-50	Cable, W2
ASI-26-01C	T321703-51	Cable, W3

TARSYN/VG-14 Field Test Fixture

ASI-260-2

OEM Equivalent:

OEM: Sperry
 Model Number:
 Part Number: T321705
 Manual: 31-3000-01
 Manual Figure: 1-12
 This unit is manufactured to replace the OEM MN, PN, and/or manual figure listed in Form, Fit, and Function.

Description:

The ASI-260-2 Field Test Fixture is identical to the ASI-260-1 but without the API faceplate mounting cutouts. An external user supplied API (NAI 8500 or equivalent) is required for proper operation.

The ASI-260-2 includes three test cables required for proper operation. See the ASI-260-1 for optional equipment.

Units Tested:

VG-14	VG-14H	TARSYN
VG-14A	VG-401	TARSYN-H

Specifications:

Height: 15.75" Width: 19.00" Depth: 7.00"
 Power Requirements: 115 VAC 400 Hz

Equipment Supplied:

ASI MN	OEM PN	Description
ASI-26-02A	T321705-49	Cable, W1
ASI-26-02B	T321705-50	Cable, W2
ASI-26-02C	T321705-51	Cable, W3

Optional Equipment: (See ASI-260-1)

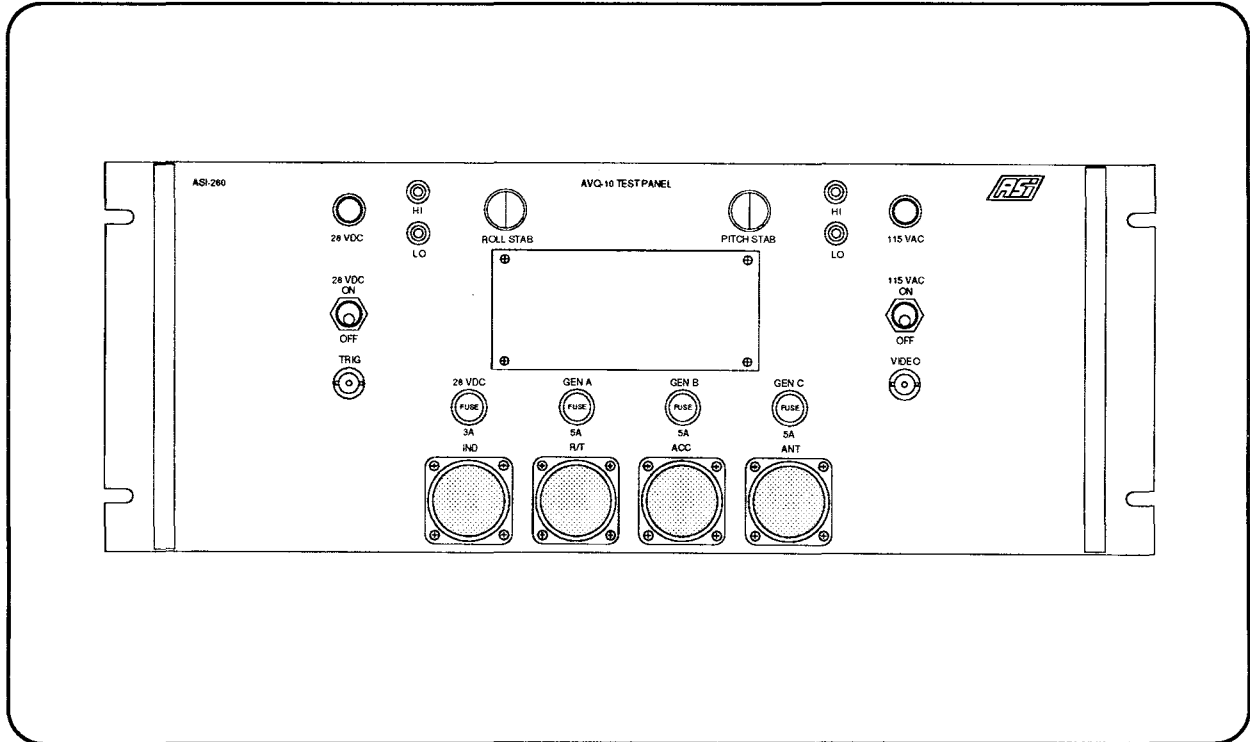

This unit is manufactured to replace the OEM model and/or part number listed below in form, fit, and function.

Equivalent OEM: RCA
 Equivalent MN:
 Equivalent PN:
 Manual Figure:

Units Tested:
 AVQ-10 Weather Radar Systems

Description of Operation:

The ASI-262 Test Panel is used for the testing, troubleshooting, and alignment of the RCA AVQ-10 Weather Radar System. It provides complete interconnection between the Receiver/Transmitter, Indicator, Antenna, Accessory Unit, and user-supplied Control Head (such as Gables G-807B, G-1404, or G-2320). The Test Panel also provides stabilization signals simulating the in-aircraft gyro.

The ASI-262 includes all cables necessary to operate the AVQ-10 system.

Specifications:

Height: 8.00" Width: 19.00" Depth: 12.00" Power: 115 VAC 400 Hz and 28 VDC

Equipment Supplied:

ASI MN	Equivalent PN	Description
ASI-26-2A		Cable: ASI-262 to AVQ-10 Indicator
ASI-26-2B		Cable: ASI-262 to AVQ-10 R/T
ASI-26-2C		Cable: ASI-262 to AVQ-10 Accessory Unit
ASI-26-2D		Cable: ASI-262 to AVQ-10 Antenna

Optional Equipment:

ASI MN	Equivalent PN	Description
--------	---------------	-------------

Primus 450/650/870 Weather Radar Test Panel		ASI-263																																													
Description: The ASI-263 Test Panel is used for the testing, troubleshooting, and alignment of the Honeywell Primus 450/650/870 Weather Radar System. The ASI-263 functions as a junction box, power source, and provides inputs/outputs as required during testing. Standard system interconnect cables are included with the ASI-263 Test Panel.		OEM Equivalent: OEM: Honeywell Model Number: HWX-650/870 Part Number: T334612 Man. Figure: WI-450/650/870, Fig. 901 WC-650/870, Fig. 901 WU-450/650, Fig. 901 WU-870, Fig. 901																																													
Optional Equipment: <table border="1"> <thead> <tr> <th>ASI MN</th> <th>OEM PN</th> <th>Description</th> </tr> </thead> <tbody> <tr> <td>ASI-26-3E</td> <td>NPN</td> <td>Cable: ASI-263 to Test Display Unit (T334579)</td> </tr> <tr> <td>ASI-26-3F</td> <td>NPN</td> <td>Cable: Test Card Extender A for WC-650/870</td> </tr> <tr> <td>ASI-26-3G</td> <td>NPN</td> <td>Cable: Test Card Extender B for WC-650/870</td> </tr> <tr> <td>ASI-26-3H</td> <td>NPN</td> <td>Fixture: Cover-on Template (Fig. 904)</td> </tr> <tr> <td>ASI-26-3J</td> <td>NPN</td> <td>High Voltage Jumper</td> </tr> <tr> <td>ASI-26-3K1</td> <td>NPN</td> <td>Azimuth Motor Harness Jumper</td> </tr> <tr> <td>ASI-26-3K2</td> <td>NPN</td> <td>Elevation Motor Harness Jumper</td> </tr> <tr> <td>ASI-155</td> <td>7010569-901</td> <td>Universal Digital Interface Test Set</td> </tr> <tr> <td>ASI-263-3</td> <td>7015457-901</td> <td>Air Data Simulator (ADS-100)</td> </tr> <tr> <td>ASI-263-4</td> <td>T335915</td> <td>RS-232 Adapter (Pre Mod N)</td> </tr> <tr> <td>ASI-264</td> <td>T334822</td> <td>WC-874 EFIS Aux. Conn. Test Box</td> </tr> <tr> <td>ASI-265</td> <td>7012364-902</td> <td>SCI Bus Monitor (CBM-100)</td> </tr> <tr> <td>ASI-267</td> <td>7010568-901</td> <td>Gyro Simulator (GSM-100)</td> </tr> <tr> <td>ASI-268</td> <td>NPN</td> <td>Target Simulator</td> </tr> </tbody> </table>		ASI MN	OEM PN	Description	ASI-26-3E	NPN	Cable: ASI-263 to Test Display Unit (T334579)	ASI-26-3F	NPN	Cable: Test Card Extender A for WC-650/870	ASI-26-3G	NPN	Cable: Test Card Extender B for WC-650/870	ASI-26-3H	NPN	Fixture: Cover-on Template (Fig. 904)	ASI-26-3J	NPN	High Voltage Jumper	ASI-26-3K1	NPN	Azimuth Motor Harness Jumper	ASI-26-3K2	NPN	Elevation Motor Harness Jumper	ASI-155	7010569-901	Universal Digital Interface Test Set	ASI-263-3	7015457-901	Air Data Simulator (ADS-100)	ASI-263-4	T335915	RS-232 Adapter (Pre Mod N)	ASI-264	T334822	WC-874 EFIS Aux. Conn. Test Box	ASI-265	7012364-902	SCI Bus Monitor (CBM-100)	ASI-267	7010568-901	Gyro Simulator (GSM-100)	ASI-268	NPN	Target Simulator	Units Tested: WC-650/870/874 WI-440/450/650/660/870/880 WU-450/650/870
ASI MN	OEM PN	Description																																													
ASI-26-3E	NPN	Cable: ASI-263 to Test Display Unit (T334579)																																													
ASI-26-3F	NPN	Cable: Test Card Extender A for WC-650/870																																													
ASI-26-3G	NPN	Cable: Test Card Extender B for WC-650/870																																													
ASI-26-3H	NPN	Fixture: Cover-on Template (Fig. 904)																																													
ASI-26-3J	NPN	High Voltage Jumper																																													
ASI-26-3K1	NPN	Azimuth Motor Harness Jumper																																													
ASI-26-3K2	NPN	Elevation Motor Harness Jumper																																													
ASI-155	7010569-901	Universal Digital Interface Test Set																																													
ASI-263-3	7015457-901	Air Data Simulator (ADS-100)																																													
ASI-263-4	T335915	RS-232 Adapter (Pre Mod N)																																													
ASI-264	T334822	WC-874 EFIS Aux. Conn. Test Box																																													
ASI-265	7012364-902	SCI Bus Monitor (CBM-100)																																													
ASI-267	7010568-901	Gyro Simulator (GSM-100)																																													
ASI-268	NPN	Target Simulator																																													
Specifications: H: 8.75" W: 19.00" D: 6.00" Power: 115 VAC 400 Hz / 28 VDC		Equipment Supplied: <table border="1"> <thead> <tr> <th>ASI MN</th> <th>OEM PN</th> <th>Description</th> </tr> </thead> <tbody> <tr> <td>ASI-26-3A</td> <td>NPN</td> <td>Cable: ASI-263 to WU-450/650 RTA</td> </tr> <tr> <td>ASI-26-3B</td> <td>NPN</td> <td>Cable: ASI-263 to WU-870 RTA</td> </tr> <tr> <td>ASI-26-3C</td> <td>NPN</td> <td>Cable: ASI-263 to WI-450/650/870 Indicator</td> </tr> <tr> <td>ASI-26-3D</td> <td>NPN</td> <td>Cable: ASI-263 to WC-450/650 (P401)</td> </tr> </tbody> </table>	ASI MN	OEM PN	Description	ASI-26-3A	NPN	Cable: ASI-263 to WU-450/650 RTA	ASI-26-3B	NPN	Cable: ASI-263 to WU-870 RTA	ASI-26-3C	NPN	Cable: ASI-263 to WI-450/650/870 Indicator	ASI-26-3D	NPN	Cable: ASI-263 to WC-450/650 (P401)																														
ASI MN	OEM PN	Description																																													
ASI-26-3A	NPN	Cable: ASI-263 to WU-450/650 RTA																																													
ASI-26-3B	NPN	Cable: ASI-263 to WU-870 RTA																																													
ASI-26-3C	NPN	Cable: ASI-263 to WI-450/650/870 Indicator																																													
ASI-26-3D	NPN	Cable: ASI-263 to WC-450/650 (P401)																																													
Primus 331/440/660/880 Weather Radar Test Set		ASI-263-2																																													
Description: The ASI-263-2 Test Set is used for the testing, troubleshooting, and alignment of the Honeywell Primus 331/440/660/880 Weather Radar System. The ASI-263-2 functions as a junction box, power source, and provides inputs/outputs as required during testing. Standard system interconnect cables are included with the ASI-263-2 Test Panel. A list of optional test fixtures is shown below.		OEM Equivalent: OEM: Honeywell Model Number: HWX-660/880 Part Number: T336162 Man. Figure: WU-331/440/660/880 Fig. 901																																													
Optional Equipment: <table border="1"> <thead> <tr> <th>ASI MN</th> <th>OEM PN</th> <th>Description</th> </tr> </thead> <tbody> <tr> <td>ASI-26-32D</td> <td>T336275</td> <td>A1/A2 Extender Cable, 68 Pos</td> </tr> <tr> <td>ASI-155</td> <td>7010569-901</td> <td>Universal Digital Interface Test Set</td> </tr> <tr> <td>ASI-265</td> <td>7012364-902</td> <td>SCI Bus Monitor (CBM-100)</td> </tr> </tbody> </table>		ASI MN	OEM PN	Description	ASI-26-32D	T336275	A1/A2 Extender Cable, 68 Pos	ASI-155	7010569-901	Universal Digital Interface Test Set	ASI-265	7012364-902	SCI Bus Monitor (CBM-100)	Units Tested: WC-440/660/880 WI-440/450/650/660/870/880 WU-331/440/660/880																																	
ASI MN	OEM PN	Description																																													
ASI-26-32D	T336275	A1/A2 Extender Cable, 68 Pos																																													
ASI-155	7010569-901	Universal Digital Interface Test Set																																													
ASI-265	7012364-902	SCI Bus Monitor (CBM-100)																																													
Specifications: H: 13.00" W: 17.00" D: 3.00" Power: 115 VAC 400 Hz / 28 VDC		Equipment Supplied: <table border="1"> <thead> <tr> <th>ASI MN</th> <th>OEM PN</th> <th>Description</th> </tr> </thead> <tbody> <tr> <td>ASI-26-32A</td> <td>T336162-41</td> <td>Cable: ASI-263-2 to WI-440/660/880 Indicator</td> </tr> <tr> <td>ASI-26-32B</td> <td>T336162-44</td> <td>Cable: ASI-263-2 to WC-440/660/880 Controller</td> </tr> <tr> <td>ASI-26-32C</td> <td>NPN</td> <td>Cable: ASI-263-2 to WU-331/440/660/880 RTA</td> </tr> </tbody> </table>	ASI MN	OEM PN	Description	ASI-26-32A	T336162-41	Cable: ASI-263-2 to WI-440/660/880 Indicator	ASI-26-32B	T336162-44	Cable: ASI-263-2 to WC-440/660/880 Controller	ASI-26-32C	NPN	Cable: ASI-263-2 to WU-331/440/660/880 RTA																																	
ASI MN	OEM PN	Description																																													
ASI-26-32A	T336162-41	Cable: ASI-263-2 to WI-440/660/880 Indicator																																													
ASI-26-32B	T336162-44	Cable: ASI-263-2 to WC-440/660/880 Controller																																													
ASI-26-32C	NPN	Cable: ASI-263-2 to WU-331/440/660/880 RTA																																													
Primus 800 Weather Radar Test Panel		ASI-266																																													
Description: The ASI-266 Test Panel is used for the testing, troubleshooting, and alignment of the Honeywell Primus 800 Weather Radar System. The ASI-266 functions as a junction box, power source, and provides inputs/outputs as required during testing. Standard system interconnect cables are included with the ASI-266 Test Panel. A list of optional cables and test fixtures is shown below.		OEM Equivalent: OEM: Honeywell Model Number: HWX-800 Part Number: T334714 Man. Figure: WC-800, Fig. 903, Tab 904 WR-800, Fig 902, Tab. 902																																													
Optional Equipment: <table border="1"> <thead> <tr> <th>ASI MN</th> <th>OEM PN</th> <th>Description</th> </tr> </thead> <tbody> <tr> <td>ASI-26-6E</td> <td>NPN</td> <td>Cable: ASI-266 to WC-810/874/884 (P402)</td> </tr> <tr> <td>ASI-26-6F</td> <td>NPN</td> <td>Cable: ASI-266 to Test Display Unit (T334579)</td> </tr> <tr> <td>ASI-26-6G</td> <td>NPN</td> <td>Test Card Extender A for WC-8XX</td> </tr> <tr> <td>ASI-26-6H</td> <td>NPN</td> <td>Test Card Extender B for WC-8XX</td> </tr> <tr> <td>ASI-26-6J</td> <td>NPN</td> <td>Elevation Drive Cable Adjustment Tool</td> </tr> <tr> <td>ASI-155</td> <td>7010569-901</td> <td>Universal Digital Interface Test Set</td> </tr> <tr> <td>ASI-265</td> <td>7012364-902</td> <td>SCI Bus Monitor (CBM-100)</td> </tr> <tr> <td>ASI-266-4</td> <td>7010571-901</td> <td>Modulator Dummy Load</td> </tr> <tr> <td>ASI-266-5</td> <td>7015904-904</td> <td>Digital Protractor Adapter</td> </tr> <tr> <td>ASI-267</td> <td>7010568-901</td> <td>Gyro Simulator (GSM-100)</td> </tr> </tbody> </table>		ASI MN	OEM PN	Description	ASI-26-6E	NPN	Cable: ASI-266 to WC-810/874/884 (P402)	ASI-26-6F	NPN	Cable: ASI-266 to Test Display Unit (T334579)	ASI-26-6G	NPN	Test Card Extender A for WC-8XX	ASI-26-6H	NPN	Test Card Extender B for WC-8XX	ASI-26-6J	NPN	Elevation Drive Cable Adjustment Tool	ASI-155	7010569-901	Universal Digital Interface Test Set	ASI-265	7012364-902	SCI Bus Monitor (CBM-100)	ASI-266-4	7010571-901	Modulator Dummy Load	ASI-266-5	7015904-904	Digital Protractor Adapter	ASI-267	7010568-901	Gyro Simulator (GSM-100)	Units Tested: WA-800 WC-800/810/874/884 WI-800 WR-800												
ASI MN	OEM PN	Description																																													
ASI-26-6E	NPN	Cable: ASI-266 to WC-810/874/884 (P402)																																													
ASI-26-6F	NPN	Cable: ASI-266 to Test Display Unit (T334579)																																													
ASI-26-6G	NPN	Test Card Extender A for WC-8XX																																													
ASI-26-6H	NPN	Test Card Extender B for WC-8XX																																													
ASI-26-6J	NPN	Elevation Drive Cable Adjustment Tool																																													
ASI-155	7010569-901	Universal Digital Interface Test Set																																													
ASI-265	7012364-902	SCI Bus Monitor (CBM-100)																																													
ASI-266-4	7010571-901	Modulator Dummy Load																																													
ASI-266-5	7015904-904	Digital Protractor Adapter																																													
ASI-267	7010568-901	Gyro Simulator (GSM-100)																																													
Specifications: H: 14.00" W: 19.00" D: 8.00" Power: 115 VAC 400 Hz / 28 VDC		Equipment Supplied: <table border="1"> <thead> <tr> <th>ASI MN</th> <th>OEM PN</th> <th>Description</th> </tr> </thead> <tbody> <tr> <td>ASI-26-6A</td> <td>NPN</td> <td>Cable: ASI-266 to WR-800 R/T (P201 / P202)</td> </tr> <tr> <td>ASI-26-6B</td> <td>NPN</td> <td>Cable: ASI-266 to WA-800 Antenna (P301)</td> </tr> <tr> <td>ASI-26-6C</td> <td>NPN</td> <td>Cable: ASI-266 to WI-800 Indicator (P101)</td> </tr> <tr> <td>ASI-26-6D</td> <td>NPN</td> <td>Cable: ASI-266 to WC-8XX Controller (P401)</td> </tr> </tbody> </table>	ASI MN	OEM PN	Description	ASI-26-6A	NPN	Cable: ASI-266 to WR-800 R/T (P201 / P202)	ASI-26-6B	NPN	Cable: ASI-266 to WA-800 Antenna (P301)	ASI-26-6C	NPN	Cable: ASI-266 to WI-800 Indicator (P101)	ASI-26-6D	NPN	Cable: ASI-266 to WC-8XX Controller (P401)																														
ASI MN	OEM PN	Description																																													
ASI-26-6A	NPN	Cable: ASI-266 to WR-800 R/T (P201 / P202)																																													
ASI-26-6B	NPN	Cable: ASI-266 to WA-800 Antenna (P301)																																													
ASI-26-6C	NPN	Cable: ASI-266 to WI-800 Indicator (P101)																																													
ASI-26-6D	NPN	Cable: ASI-266 to WC-8XX Controller (P401)																																													
Primus 700/700A/701/701A Weather Radar Test Panel		ASI-266-2A																																													
Description: The ASI-266-2A Test Panel is used for the testing, troubleshooting, and alignment of the Primus 700()/701() Radar System. The ASI-266-2A functions as a junction box, power source, and provides inputs/outputs required during testing. System interconnect cables are included. Optional test fixtures are listed below.		OEM Equivalent: OEM: Honeywell Model Number: HWX-700A Part Number: T337333 Man. Figure: WR-700/701 Fig: 901 WR-700A/701A Fig: 1001																																													
Optional Equipment: <table border="1"> <thead> <tr> <th>ASI MN</th> <th>OEM PN</th> <th>Description</th> </tr> </thead> <tbody> <tr> <td>ASI-155</td> <td>7010569-901</td> <td>Universal Digital Interface Test Set</td> </tr> <tr> <td>ASI-263-3</td> <td>7015457-901</td> <td>Air Data Simulator (ADS-100)</td> </tr> <tr> <td>ASI-266-2</td> <td>7015455-901</td> <td>Primus 700/701 Test Panel (HWX-700)</td> </tr> <tr> <td>ASI-266-3</td> <td>7016068-901</td> <td>Access Interface Fixture (ACI-100)</td> </tr> <tr> <td>ASI-266-4</td> <td>7010571-901</td> <td>Modulator Dummy Load</td> </tr> <tr> <td>ASI-266-5</td> <td>7015904-904</td> <td>Digital Protractor Adapter</td> </tr> <tr> <td>ASI-264</td> <td>T334822</td> <td>WC-874 EFIS Aux. Conn. Test Box</td> </tr> <tr> <td>ASI-265</td> <td>7012364-902</td> <td>SCI Bus Monitor (CBM-100)</td> </tr> <tr> <td>ASI-267</td> <td>7010568-901</td> <td>Gyro Simulator (GSM-100)</td> </tr> <tr> <td>ASI-268</td> <td>NPN</td> <td>Target Simulator</td> </tr> </tbody> </table>		ASI MN	OEM PN	Description	ASI-155	7010569-901	Universal Digital Interface Test Set	ASI-263-3	7015457-901	Air Data Simulator (ADS-100)	ASI-266-2	7015455-901	Primus 700/701 Test Panel (HWX-700)	ASI-266-3	7016068-901	Access Interface Fixture (ACI-100)	ASI-266-4	7010571-901	Modulator Dummy Load	ASI-266-5	7015904-904	Digital Protractor Adapter	ASI-264	T334822	WC-874 EFIS Aux. Conn. Test Box	ASI-265	7012364-902	SCI Bus Monitor (CBM-100)	ASI-267	7010568-901	Gyro Simulator (GSM-100)	ASI-268	NPN	Target Simulator	Units Tested: WC-700/701 WI-700 WR-700/700A/701/701A												
ASI MN	OEM PN	Description																																													
ASI-155	7010569-901	Universal Digital Interface Test Set																																													
ASI-263-3	7015457-901	Air Data Simulator (ADS-100)																																													
ASI-266-2	7015455-901	Primus 700/701 Test Panel (HWX-700)																																													
ASI-266-3	7016068-901	Access Interface Fixture (ACI-100)																																													
ASI-266-4	7010571-901	Modulator Dummy Load																																													
ASI-266-5	7015904-904	Digital Protractor Adapter																																													
ASI-264	T334822	WC-874 EFIS Aux. Conn. Test Box																																													
ASI-265	7012364-902	SCI Bus Monitor (CBM-100)																																													
ASI-267	7010568-901	Gyro Simulator (GSM-100)																																													
ASI-268	NPN	Target Simulator																																													
Specifications: H: 14.00" W: 19.00" D: 8.00" Power: 115 VAC 400 Hz / 28 VDC		Equipment Supplied: <table border="1"> <thead> <tr> <th>ASI MN</th> <th>OEM PN</th> <th>Description</th> </tr> </thead> <tbody> <tr> <td>ASI-26-62A1</td> <td>NPN</td> <td>Cable: ASI-266-2A to WR-700()/701() R/T (P201)</td> </tr> <tr> <td>ASI-26-62B1</td> <td>NPN</td> <td>Cable: ASI-266-2A to WA-700 Antenna (P301)</td> </tr> <tr> <td>ASI-26-62C1</td> <td>NPN</td> <td>Cable: ASI-266-2A to WI-700 Indicator (P101)</td> </tr> <tr> <td>ASI-26-62D1</td> <td>NPN</td> <td>Cable: ASI-266-2A to WC-700 Control (P401)</td> </tr> <tr> <td>ASI-26-62E1</td> <td>NPN</td> <td>Cable: ASI-266-2A to WC-700 Control (P601)</td> </tr> <tr> <td>ASI-26-62F1</td> <td>NPN</td> <td>Cable: ASI-266-2A to WC-701 BCN Control (P501)</td> </tr> </tbody> </table>	ASI MN	OEM PN	Description	ASI-26-62A1	NPN	Cable: ASI-266-2A to WR-700()/701() R/T (P201)	ASI-26-62B1	NPN	Cable: ASI-266-2A to WA-700 Antenna (P301)	ASI-26-62C1	NPN	Cable: ASI-266-2A to WI-700 Indicator (P101)	ASI-26-62D1	NPN	Cable: ASI-266-2A to WC-700 Control (P401)	ASI-26-62E1	NPN	Cable: ASI-266-2A to WC-700 Control (P601)	ASI-26-62F1	NPN	Cable: ASI-266-2A to WC-701 BCN Control (P501)																								
ASI MN	OEM PN	Description																																													
ASI-26-62A1	NPN	Cable: ASI-266-2A to WR-700()/701() R/T (P201)																																													
ASI-26-62B1	NPN	Cable: ASI-266-2A to WA-700 Antenna (P301)																																													
ASI-26-62C1	NPN	Cable: ASI-266-2A to WI-700 Indicator (P101)																																													
ASI-26-62D1	NPN	Cable: ASI-266-2A to WC-700 Control (P401)																																													
ASI-26-62E1	NPN	Cable: ASI-266-2A to WC-700 Control (P601)																																													
ASI-26-62F1	NPN	Cable: ASI-266-2A to WC-701 BCN Control (P501)																																													

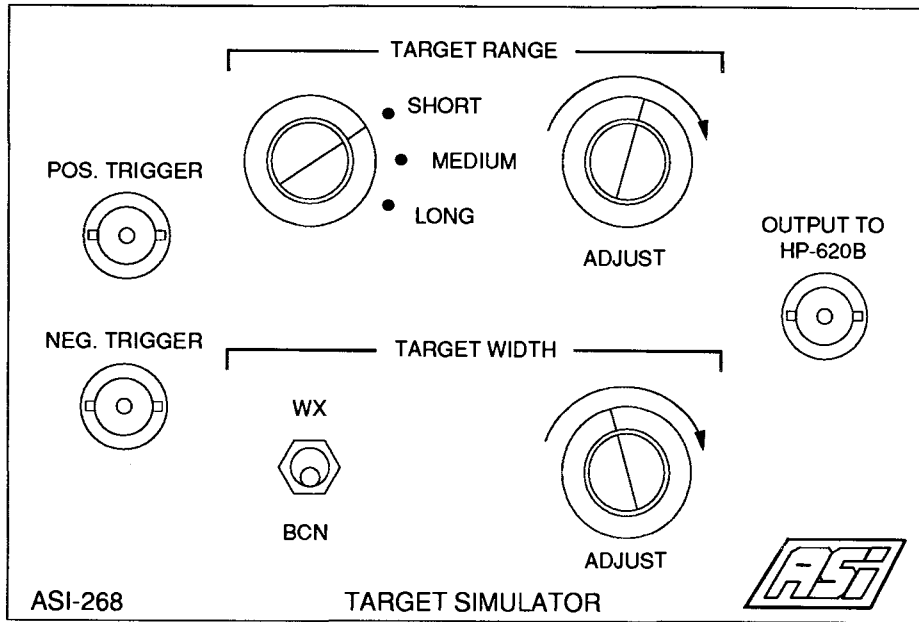

This unit is manufactured to replace the OEM model and/or part number listed below in form, fit, and function.

Equivalent OEM: Honeywell/Sperry/RCA

Units Tested:

Equivalent MN:

WU-870 WU-450/650 RTA WI-450/650/870

Equivalent PN:

Manual Figure: WU-450/650, Fig. 902

WI-450/650/870, Fig. 901, Table 901

WU-870, Fig. 902

Description of Operation:

The ASI-268 Target Simulator is configured to provide a simulated radar target return when used in conjunction with the HP-620B Signal Generator. The ASI-268 is necessary during testing of the above listed units unless an ASI-modified HP-620B or the RD-300/301 Radar Test Set is utilized.

Specifications:

Height: 5.00" Width: 7.00" Depth: 3.00"

Power: 28 VDC

Equipment Supplied:

ASI MN	Equivalent PN	Description

Optional Equipment:

ASI MN	Equivalent PN	Description

C14 Preliminary and Final Test Fixture

ASI-275-1

OEM Equivalent:

OEM: Sperry
 Model Number:
 Part Number: T307976
 Manual: 31-3000-01
 Manual Figure: 1-6

This unit is manufactured to replace the OEM MN, PN, and/or manual figure listed in Form, Fit, and Function.

Description:

The ASI-275-1 provides power, loads, and signals required to test and calibrate the Sperry C-14/-14A/-14D Directional Gyros.

Optional Equipment:

ASI MN	OEM PN	Description (Manual 31-3000-01 Figure)
ASI-27-5A1	T322745-1	Adapter Cable, 4019190-1/2/3/4/5/6/7 (1-14)
ASI-27-5A2	T322745-2	Adapter Cable, 4019190-13/-16/-18 (1-14)
ASI-27-5A3	T322771	Adapter Cable, 4019190-13/-16 (1-15)
ASI-27-5A4	T322870	Adapter Cable, 4020577-3/-6/-8 (1-18)
ASI-27-5B	T307972	Scorsby Adapter Plate (1-5)
ASI-27-5C1	T3012061-A	Rotor Clamp A (2-42)
ASI-27-5C2	T3012061-B	Rotor Clamp B (2-42)
ASI-27-5D	T3012066	Rotor Assembly Bushing (2-45)
ASI-27-5E	T897487	Height Dimension Gauge (2-23)
ASI-27-5F	T3075022	Holding Fixture (2-52)
ASI-27-5G	T898487	Open End Wrench (2-25)
ASI-27-5H	T896500	Bearing Preload Adapter Set (2-14)
ASI-27-5I	T891970	Bearing Preload Fixture (2-6)
ASI-27-5J	T896497	Rotor Balancing Adapters (2-12)
ASI-27-5K	T896276	Rotor Balancing Cradle (2-8)
ASI-27-5L	T897024	Terminal Inserter (2-19)
ASI-27-5M	T897413	Slipring Cementing Clamps (2-22)
ASI-27-5N	T896625	Switch Ring Alignment Fixture (2-16)
ASI-27-5P	T896455	Magnet Cementing Fixture (2-10)
ASI-27-5Q	T897167	Static Balance Fixture (2-20)
ASI-27-5R	T896773	Slipring Aligning and Cementing Tool (2-17)
ASI-27-5S	T896871	Slipring Protector (2-18)
ASI-27-5T	T898023	Dial Indicator Mounting Adapter (2-24)
ASI-27-5U	T896598	Gimbal Assembly Balance Fixture (2-15)
ASI-27-5V	T3008089	Dial Indicator Mounting Adapter (2-30)
ASI-27-5W	T896496	Stator Loc. and Cementing Fixture (2-11)
ASI-27-5X	T3009480	Weight (2-32)
ASI-27-5Y	T896405	Punch and Anvil (2-9)
ASI-27-5Z	T896499	Pressing Tool (2-13)
ASI-407-1	T307702-4	Power Supply and Readout (1-3)
ASI-408	T322861	C-14 Base Test Fixture (1-17)
ASI-410	T307967	Flux Valve Simulator (1-4)

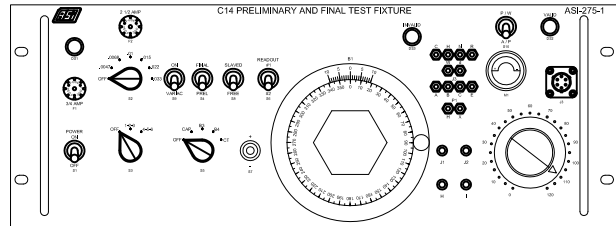

Units Tested:

C-14 C-14D
 C-14A DG-401

Specifications:

Height: 7.00" Width: 19.00" Depth: 6.00"
 Power Requirements: 26 VAC and 115 VAC 400 Hz

Equipment Supplied:

ASI MN	OEM PN	Description
ASI-27-51A	T-307976-48	Cable, W1
ASI-27-51B	T-307976-42	Cable, W2
ASI-27-51C	T-307976-58	Cable, W3

DG-401 Calibration Fixture

ASI-275-2

OEM Equivalent:

OEM: Sperry
 Model Number:
 Part Number: T307977
 Manual: 31-3000-01
 Manual Figure: 1-7

This unit is manufactured to replace the OEM MN, PN, and/or manual figure listed in Form, Fit, and Function.

Description:

The ASI-275-2 Calibration Fixture functions to test and repair the Sperry DG-401 Gyro Amplifier and C-14() Directional Gyro. The ASI-275-2 may be used in place of the ASI-275-1 to perform tests on leveling rates, drifts, slow slave rates, and settling error. In addition, this fixture provides the power and loads to test the clutch potentiometer B4 (engage-disengage test) for the gyro synchronizer (4019190-2/-5).

The ASI-275-2 includes six identical cables (ASI-27-52A) which enable the ASI-275-2 to test and run up to six units simultaneously.

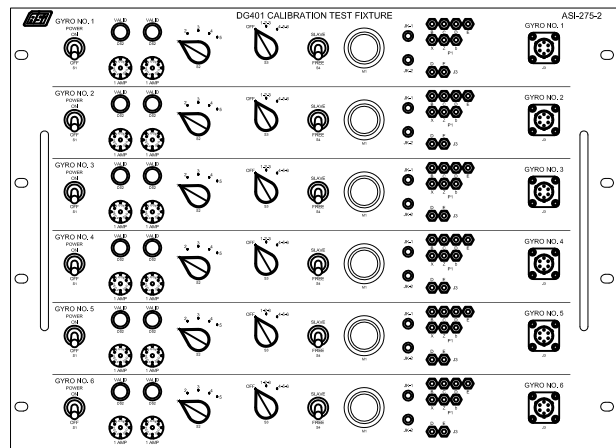

Units Tested:

C-14 C-14D
 C-14A DG-401

Specifications:

Height: 14.00" Width: 19.00" Depth: 10.00"
 Power Requirements: 115 VAC 400 Hz

Equipment Supplied:

ASI MN	OEM PN	Description
ASI-27-52A	T307977-40	Cable, W1 (Qty-6)
ASI-27-52B	T309077-39	Cable, W2 (Qty-2)

Optional Equipment: (See ASI-275-1)

ASI MN	OEM PN	Description
ASI-275-1	T307976	C14() Preliminary and Final Test Fixture

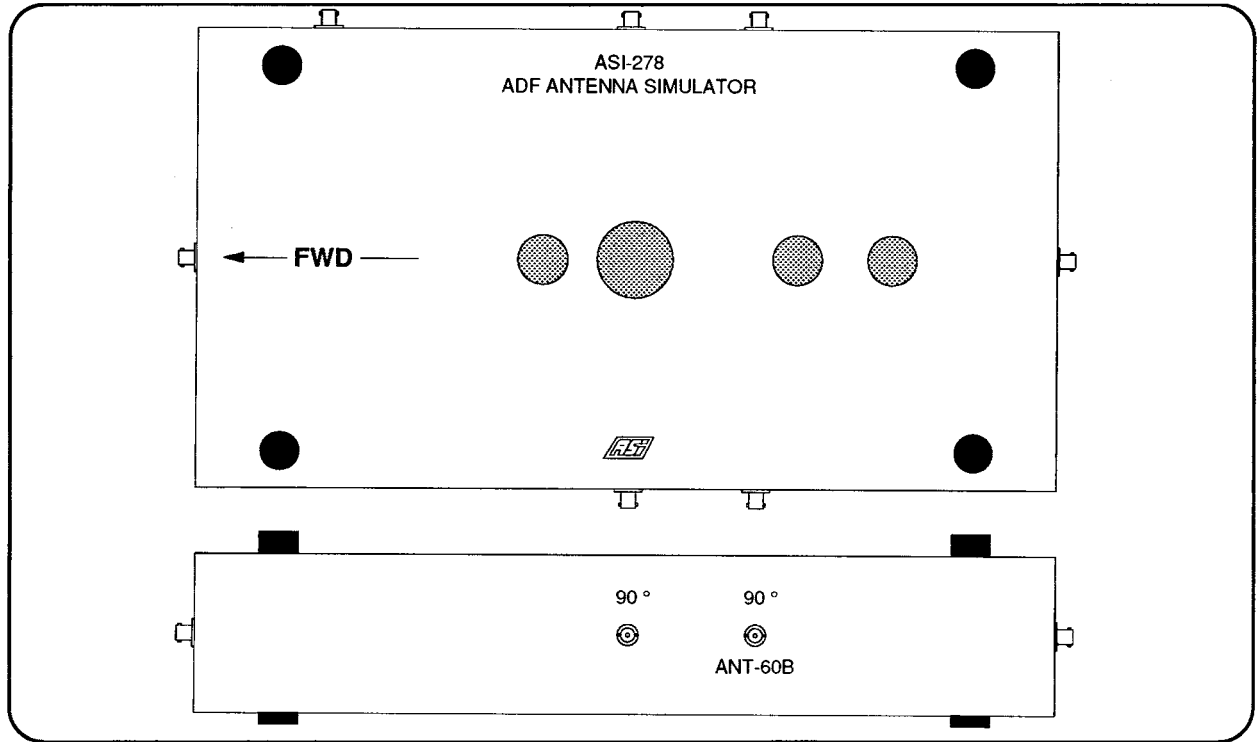

This unit is manufactured to replace the OEM model and/or part number listed below in form, fit, and function.

Equivalent OEM: Collins
 Equivalent MN: 969W-1
 Equivalent PN: 622-3874-001
 Manual Figure:

Units Tested:
 ANT-60A ADF Antenna
 ANT-60B ADF Antenna
 ANT-650A ADF Antenna
 ANT-462A ADF Antenna
 ANT-462B ADF Antenna

Description of Operation:

The ASI-278 is used to simulate ADF bearing signals for testing Collins ADF-60(), ADF-462(), and ANT-650A antennas. When used together with an ADF antenna, the ASI-278 can be substituted for the ASI-186 (970W-1) ADF Loop Antenna Simulator during ADF receiver testing.

The ASI-278 also affords an easy means of performing an antenna functional check without removing it from the aircraft. The cover is removed from the Tester and the chassis is placed over the antenna. A bearing signal can then be simulated and the ADF indicator observed to confirm operation of the antenna.

Specifications:

Height: 12.75" Width: 26.00" Depth: 3.00" Power: None required

Equipment Supplied:

ASI MN	Equivalent PN	Description
--------	---------------	-------------

Optional Equipment:

ASI MN	Equivalent PN	Description
ASI-185	622-2854-001	ADF-60() Test Set (970G-1)
ASI-18-5C	NPN	Cable: ASI-185 to ANT-60B / ANT-462B

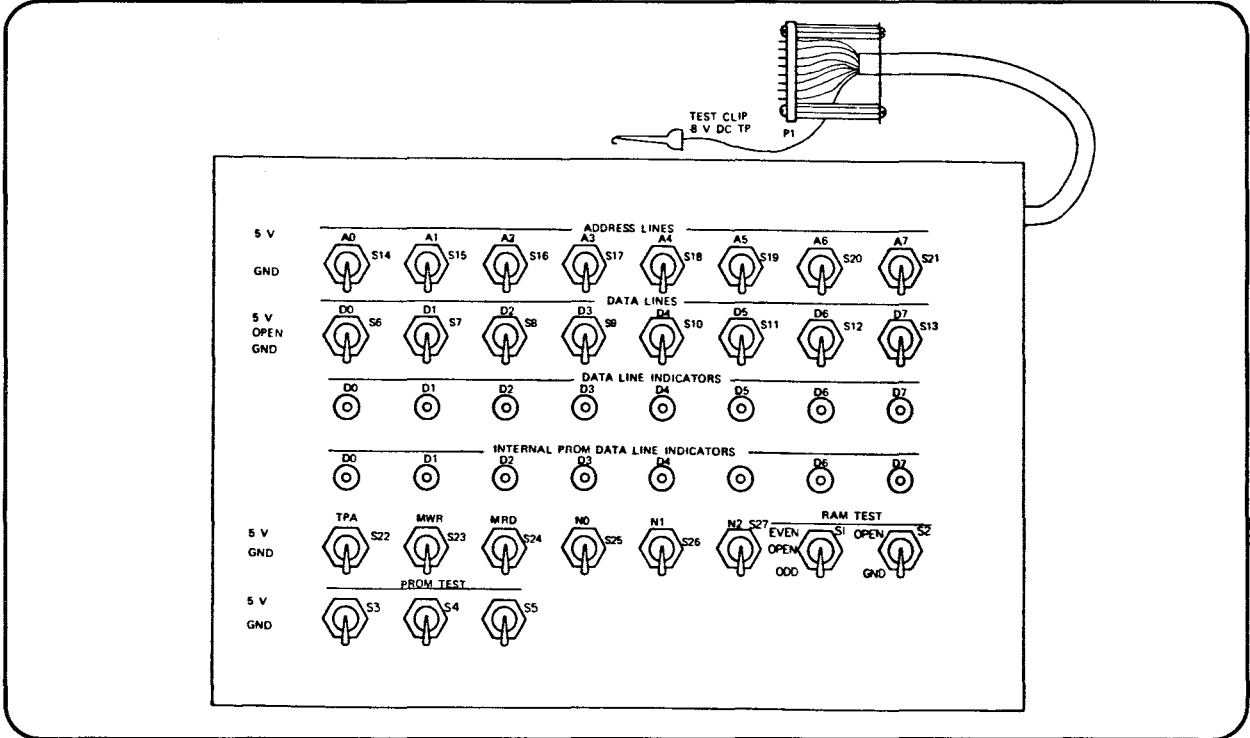

This unit is manufactured to replace the OEM model and/or part number listed below in form, fit, and function.

Equivalent OEM: Collins

Units Tested:

Equivalent MN:

51R-10/10() VOR/LOC Navigation Receiver

Equivalent PN:

51RV-4/4() VOR/LOC Navigation Receiver

Manual Figure: 51R-10/10(), Fig. 911-913

51RV-4/4(), Fig. 911-913

Description of Operation:

The ASI-280 CPU Test Set provides a method of testing RAM, PROM, decoder, latches, and buffers on the A3 card. The Test Set also allows a bearing test by placing binary sine and cosine bits on the data lines via switches on the faceplate. Power is supplied by the circuit card under test.

Specifications:

Height: 8.00" Width: 12.00" Depth: 3.00"

Power: Provided by A3 circuit card

Equipment Supplied:

ASI MN	Equivalent PN	Description

Optional Equipment:

ASI MN	Equivalent PN	Description

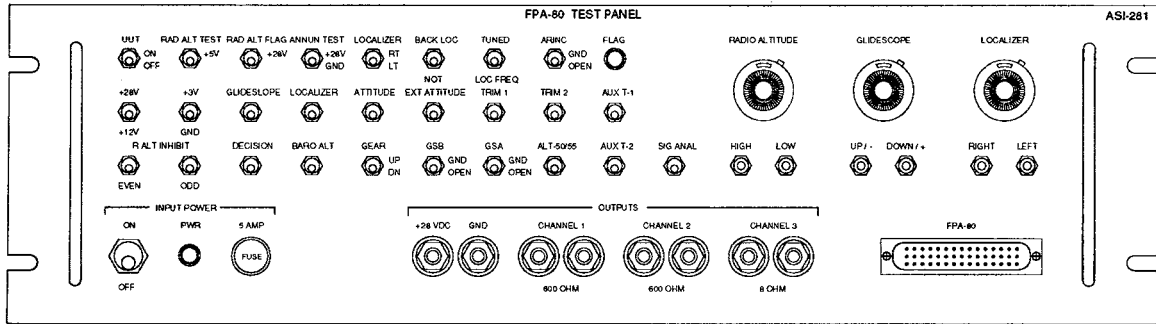

This unit is manufactured to replace the OEM model and/or part number listed below in form, fit, and function.

Equivalent OEM: Collins

Units Tested:

Equivalent MN:

FPA-80

Equivalent PN:

Manual Figure: FPA-80, Fig. 5-1 - 5-3

Description of Operation:

The ASI-281 supplies power, input/output signals, and interface required to test the Collins FPA-80 Flight Profile Advisory.

An interface cable (ASI-28-1A) is supplied with the test panel.

Specifications:

Height: 5.25" Width: 19.00" Depth: 6.00"

Power: 28 VDC

Equipment Supplied:

ASI MN	Equivalent PN	Description
ASI-28-1A		Cable: ASI-281 to Collins FPA-80

Optional Equipment:

ASI MN	Equivalent PN	Description
--------	---------------	-------------

Universal Flight Control Test Panel

ASI-282

OEM Equivalent: Rockwell Collins
 MN: 980L-1A
 PN: 622-0846-001
 Manual: 523-0764269
 Manual Figure: 1

UUT: Collins Flight Director Systems
 Collins Autopilot Systems
 Size: H: 21.00" W: 19.00" D: 10.75"
 Pwr: 28 VDC / 115 VAC 60Hz & 400Hz

Description:

The ASI-282 Universal Flight Control Test Panel is used to test various components of the Collins Flight Control Systems. The Test Panel includes AC, DC, and 3-wire power sources, meter circuitry, indicator lights and a switching matrix that interconnects points in the test panel and the uut as required during testing. The connector panel at the bottom of the ASI-282 accommodates the ASI-40Y-() / 440Y-() Plug-In Adapters that interface the ASI-282 to the individual unit under test.

The ASI-40Y-() plug-In Adapters contain the proper loads and relays for specific flight control system components. These Plug-In Adapters are required for proper operation of the ASI-282. All original Collins 440Y-() adapters will also function in the ASI-282. Please consult the ASI-40Y-() listing below for further information concerning the ASI-40Y-() adapters.

Avionics Specialist, Inc. also offers panel meter retrofit kits that will replace malfunctioning meters in the original Collins 980L-1 and 980L-1A Test Panels. The ASI-980L-1MM includes all parts required to replace meter M1 (458-0609-010) in the 980L-1 Test Panel. The 980L-1 must have service bulletin 6 installed in order for the ASI-980L-1MM function properly. The ASI-282-M1K includes all parts required to replace meter M301 (279-0194-010) in the 980L-1A per Collins service bulletin 3.

Optional Equipment:

ASI MN	OEM PN	Description
ASI-28-2A	NPN	BOX 1 Breakout Box (980L-1A Man. Fig. 20)
ASI-28-2B	NPN	PWR INTLK Shorting Conn (980L-1A Man. Fig. 21)
ASI-28-2C	NPN	BOX 2 Continuity Tester (980L-1A Man. Fig. 22)
ASI-282-M1K	NPN	980L-1A Meter Retrofit Kit
ASI-980L-1MM	NPN	980L-1 Meter Retrofit Kit

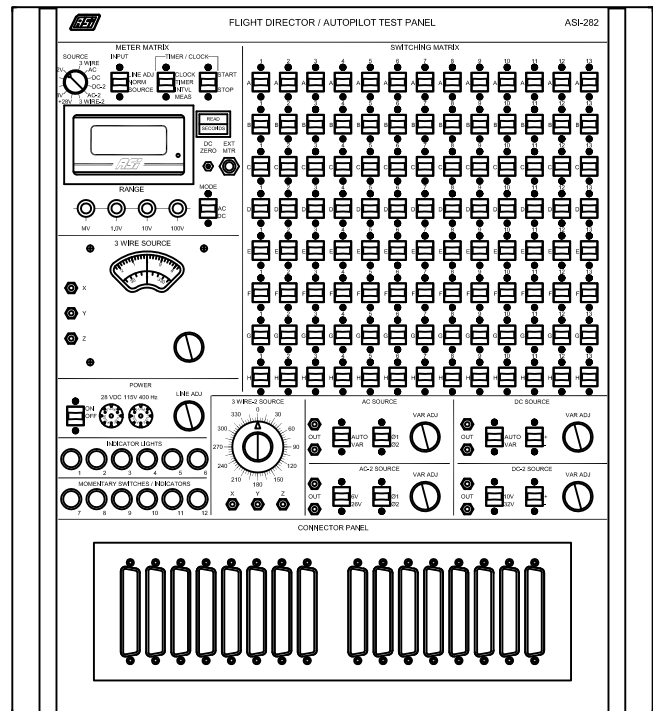

980L-1/1A Plug-In Adapters

ASI-40Y-()

The ASI-40Y-() Adapters are interchangeable in Form, Fit, and Function with the Collins 440Y-() Adapters and will operate properly with the 980L-1, 980L-1A or ASI-282. The ASI-40Y-67A, ASI-40Y-68A, ASI-40Y-69A, and ASI-40Y-76 will only operate properly when used with a 980L-1A or ASI-282.

ASI MN	OEM MN	OEM PN	OEM Manual	Description
ASI-40Y-1	440Y-1	522-4606-001	523-0762663	Plug-in Adapter: 562C-4/4E
ASI-40Y-2	440Y-2	522-4607-001	523-0762195	Plug-in Adapter: 562A-5G
ASI-40Y-3	440Y-3	522-4609-001	523-0762966	Plug-In Adapter: 161A-1/1A/1B, 332G-2, 345A-4, 590A-3A/3D/3E, 590B-2, 614E-2F/2G/2G1
ASI-40Y-5	440Y-5	522-4899-001	523-0762323	Plug-In Adapter: 562A-5F/5F1/5F4/5F5
ASI-40Y-6	440Y-6	522-4900-001	523-0762710	Plug-In Adapter: 344C-1F/1G
ASI-40Y-7	440Y-7	522-4944-001	523-0762892	Plug-In Adapter: 161E-1
ASI-40Y-8	440Y-8	522-4957-001	523-0762015	Plug-In Adapter: 344C-1D
ASI-40Y-9	440Y-9	522-4958-001	523-0762021	Plug-In Adapter: 562P-1/1E1/1F, 562R-1/1E1/1F
ASI-40Y-11	440Y-11	522-4960-001	523-0762421	Plug-In Adapter: 161F-1/1A/1B, 345C-2A
ASI-40Y-12	440Y-12	522-4961-001	523-0762115	Plug-in Adapter: 54W-1/1B/1C/1D/1E/1F
ASI-40Y-13	440Y-13	522-4962-001	523-0762644	Plug-In Adapter: 614E-7()/8B/9B/9C/9E/9G/10()/11/11A
ASI-40Y-14	440Y-14	522-4963-001	523-0761895	Plug-In Adapter: 344C-1E/1K
ASI-40Y-15	440Y-15	522-4964-001	523-0761690	Plug-In Adapter: 562A-5M/5M5
ASI-40Y-16	440Y-16	777-1035-001	523-0762185	Plug-In Adapter: 562C-4A
ASI-40Y-17	440Y-17	777-1036-001	523-0762186	Plug-In Adapter: 590A-5, 614E-4/4B
ASI-40Y-19	440Y-19	777-1038-001	523-0762967	Plug-In Adapter: 331A-8G/8H, 614E-22/22B
ASI-40Y-20	440Y-20	777-1039-001	523-0761689	Plug-In Adapter: 161E-2, 614E-20/20A/20D/20E/20J/20K/23
ASI-40Y-23	440Y-23	777-1042-001	523-0762422	Plug-In Adapter: 331A-8A/8D/8K, 331A-9G*, HSI-45* (*Requires ASI-40Y-23AB Adapter Box)
ASI-40Y-24	440Y-24	777-1043-001	523-0762718	Plug-In Adapter: 54W-3/3A/3B
ASI-40Y-25	440Y-25	777-1044-001	523-0762890	Plug-In Adapter: 323A-1, 328A-5, 332C-8, 332E-5
ASI-40Y-27	440Y-27	787-6073-001	523-0763266	Plug-In Adapter: 562C-3E
ASI-40Y-30	440Y-30	787-6139-001	523-0764622	Plug-In Adapter: 161E-6
ASI-40Y-31	440Y-31	787-6140-001	523-0764623	Plug-In Adapter: 614E-4C/27/36
ASI-40Y-33	440Y-33	787-6142-001	523-0762424	Plug-In Adapter: 329B-8J/8V/8Y/9A
ASI-40Y-34	440Y-34	787-6143-001	523-0762423	Plug-In Adapter: 54W-4
ASI-40Y-35	440Y-35	787-6144-001	523-0763277	Plug-In Adapter: 161E-7B
ASI-40Y-36	440Y-36	787-6810-001	523-0762221	Plug-In Adapter: 329B-8G
ASI-40Y-38	440Y-38	792-6383-001	523-0763596	Plug-In Adapter: 562C-5/8A/8B, 614E-5A/5C
ASI-40Y-39	440Y-39	792-6384-001	523-0763417	Plug-In Adapter: 161E-2A, 614E-20G/20H/20I/23E/23G
ASI-40Y-43	440Y-43	792-6889-001	523-0763159	Plug-In Adapter: 329B-8L/8R/8U/8Z
ASI-40Y-67A	440Y-67A	622-4086-001	523-0771658	Plug-In Adapter: FGC-80(), FGP-80(), FGP-81(), NAC-80
ASI-40Y-68A	440Y-68A	622-4087-001	523-0771658	Plug-In Adapter: APC-80(), APP-80()
ASI-40Y-69A	440Y-69A	622-4088-001	523-0771658	Plug-In Adapter: APA-80(), SVO-80()
ASI-40Y-76	440Y-76	622-6315-001	523-0773297	Plug-In Adapter: APS-65, APC-65, FGC-65

Optional Equipment:

ASI MN	OEM PN	Description
ASI-165	622-5330-001	Synchro Source Panel
ASI-167	522-0167-001	Synchro Simulator Panel
ASI-176A	NPN	DME Indicator Test Set
ASI-282	622-0846-001	Flight Control Test Panel
ASI-40Y-11-1	797-7008-001	Positioning Fixture: 345C-2A
ASI-40Y-23AB	NPN	Adapter Box: 331A-9G / HSI-45
ASI-40Y-67A-1	NPN	Diode Tester: FGP-80
ASI-40Y-67A-2	NPN	Test Expediter: FGC-80

Optional Equipment:

ASI MN	OEM PN	Description
ASI-40Y-76-1	NPN	Servo Emulator: APC-65/FGC-65
ASI-40Y-76-2	NPN	Servo Angle Indicator: APC-65/FGC-65
ASI-40Y-76-3	NPN	Front Circuit Card Extender: APC-65/FGC-65
ASI-40Y-76-4	NPN	Rear 36 Pin Circuit Card Extender: APC-65/FGC-65
ASI-40Y-76-5	NPN	Rear 30 Pin Circuit Card Extender: APC-65/FGC-65
ASI-40Y-76-6	NPN	Rear 26 Pin Circuit Card Extender: APC-65/FGC-65
ASI-40Y-76-7	NPN	EFIS Bus Cable: APC-65/FGC-65 (Pro Line II Card)
ASI-40Y-76-8	NPN	Trim Interface Panel: APC-65/FGC-65

R2

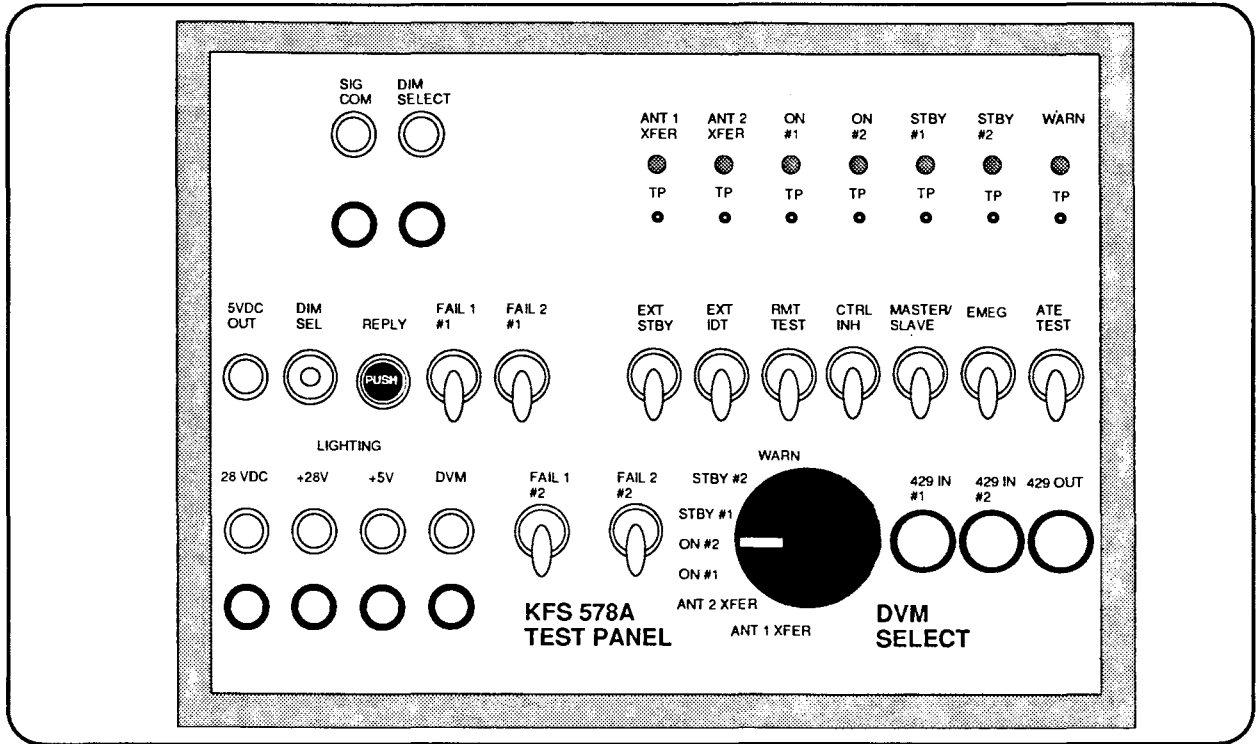

This unit is manufactured to replace the OEM model and/or part number listed below in form, fit, and function.

Equivalent OEM: Bendix / King
 Equivalent MN:
 Equivalent PN:
 Manual Figure: KFS-578A Fig 5-2

Units Tested:
 KFS-578A

Description of Operation:

The ASI-284 Test Fixture is configured to test and troubleshoot the KFS-578A Control Panel. The test fixture provides interface between the uut and other test equipment required for proper testing (Oscilloscope, Arinc 429 Bus Transceiver, Multimeter, and power supply are required but not supplied).

Since the ASI-284 is a direct replacement for the Bendix/King KFS-578A Control Panel Test Panel, by the book testing is assured.

Specifications:

Height: 3.00" Width: 5.00" Depth: 7.00"

Power: 28 vdc

Equipment Supplied:

ASI MN	Equivalent PN	Description

Optional Equipment:

ASI MN	Equivalent PN	Description

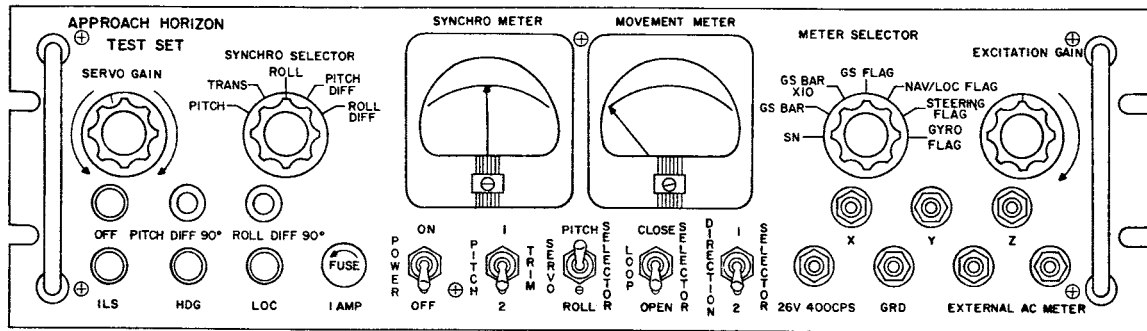

This unit is manufactured to replace the OEM model and/or part number listed below in form, fit, and function.

Equivalent OEM: Collins
 Equivalent MN: 477P-1 or 477P-1A
 Equivalent PN: 522-1150-000 or 522-3329-000
 Manual Figure:

Units Tested:
 329B-4, 329B-4A, 329B-4B, 329B-4AX
 329B-6D, 329B-6E

Description of Operation:

The ASI-285 provides functions required to test the Collins 329B-4() and 329B-6() Approach Horizons.

The ASI-285 simulates the various ac and dc inputs, checks current to meter movements and synchros, and provides ac input excitation to the servo amplifier for checking servo-motor response.

The ASI-285 requires an ASI-28-5A or ASI-28-5B cable for proper operation.

Specifications:

Height: 5.25" Width: 19.00" Depth: 6.00" Power: 115 VAC 400 Hz

Equipment Supplied:

ASI MN	Equivalent PN	Description
--------	---------------	-------------

Optional Equipment:

ASI MN	Manual Figure	Description
ASI-28-5A		Cable: ASI-285 to Collins 329B-4()
ASI-28-5B	329B -6D/E Manual Figure 1004	Cable: ASI-285 to Collins 329B-6()

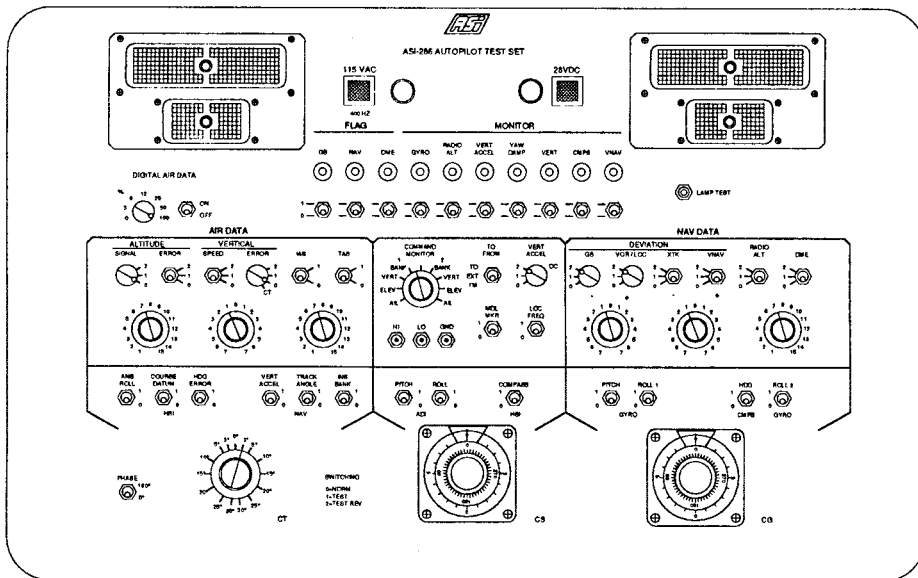

This unit is manufactured to replace the OEM model and/or part number listed below in form, fit, and function.

Equivalent OEM: Collins

Equivalent MN: CTS-82

Equivalent PN: 622-4562-001 (ASI-286-1)

622-4562-002 (ASI-286-2)

Units Tested:

FCS-80() Flight Control System

FCS-105() Flight Control System

Manual Figure:

Description of Operation:

The ASI-286 is an in-line test set used to test the FCS-80() and FCS-105() Flight Control Systems on the ground. In normal mode, the ASI-286 controls power and switching to the UUT, and will annunciate system flags and monitors. When in the test mode, the Test Set actively exercises the Flight Control System by generating signals that normally come from other units in the system. The ASI-286 is housed in a protective case for ramp use.

The ASI-286 is produced in two different models: ASI-286-1 includes test set and 10 cables (cables listed below)
 ASI-286-2 includes test set only (cables purchased separately)

Specifications:

Height: 12.25" Width: 21.30" Depth: 13.30"

Power: 115 VAC 400 Hz and 28 VDC

Equipment Supplied with ASI-286-1 (optional on ASI-286-2):

ASI MN	Equivalent PN	Description
ASI-28-6A	634-9647-001	FGC-80 Unit Cable
ASI-28-6B	634-9648-001	FGC-80 Aircraft Cable
ASI-28-6C	634-9649-001	APC-80 Unit Cable
ASI-28-6D	634-9650-001	APC-80 Aircraft Cable
ASI-28-6E	634-9651-001	APA-80 Unit Cable
ASI-28-6F	634-9652-001	APA-80 Aircraft Cable
ASI-28-6G	634-9653-001	562A-5M5 Unit Cable
ASI-28-6H	634-9654-001	562A-5M5 Aircraft Cable
ASI-28-6I	634-9655-001	562C-5 Unit Cable
ASI-28-6J	634-9656-001	562C-5 Aircraft Cable

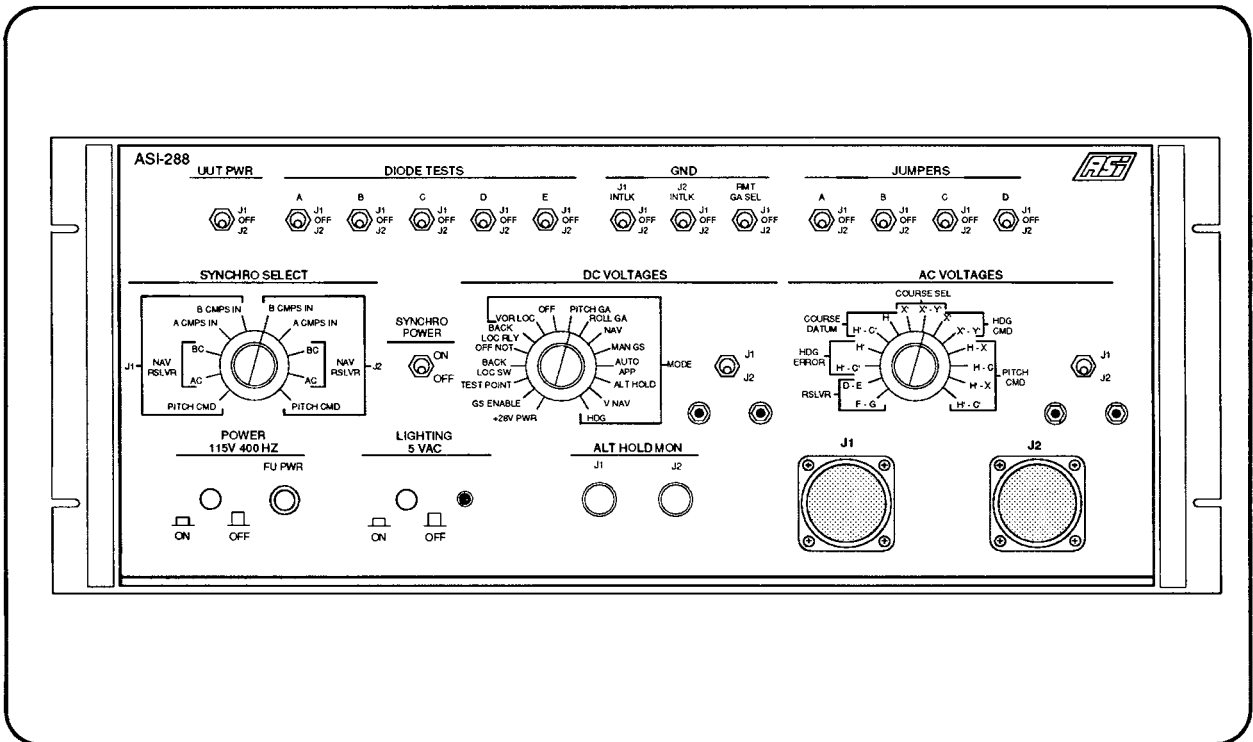

This unit is manufactured to replace the OEM model and/or part number listed below in form, fit, and function.

Equivalent OEM: Rockwell Collins
 Equivalent MN: 968A-1
 Equivalent PN: 622-3962-001
 Manual Figure:

Units Tested:
 FMC-28 / 28A Flight Mode Controller

Description of Operation:

The ASI-288 Flight Mode Control Test Panel, when used in conjunction with a synchro source, is effective for the operational testing and troubleshooting of the Collins FMC-28 / 28A Flight Mode Controller. The Test Panel provides necessary switching and monitoring jacks. All voltages needed for complete testing are developed from a 115 VAC 400 Hz input.

Interconnect and extender cables included with the ASI-288 and the optional equipment are listed below.

Specifications:

Height: 7.50" Width: 19.00" Depth: 13.50"

Power: 115 VAC 400 Hz

Equipment Supplied:

ASI MN	Equivalent MN	Description
ASI-28-8A	629-9929-001	W1 Cable: ASI-288 (J3) to FMC-28 / 28A (J1)
ASI-28-8B	629-9929-002	W2 Cable: ASI-288 (J4) to FMC-28 / 28A (J2)
ASI-28-8C	629-9935-001	W3 Cable: FMC-28 / 28A P6 to J6 extender
ASI-28-8D	629-9935-002	W4 Cable: FMC-28 / 28A P7 to J7 extender

Optional Equipment:

ASI MN	Equivalent MN	Description
ASI-28-8E	NPN	Cable: ASI-288 to ASI-166 (978F-2S)
ASI-16-6E	NPN	Cable: ASI-166 to FMC-28/28A (ORZ)
ASI-166	522-0167-001	Resolver Zeroing Panel (479X-2)
ASI-167	522-3498-000	Synchro Source (978F-2S)

REV 4
 1-27-2020

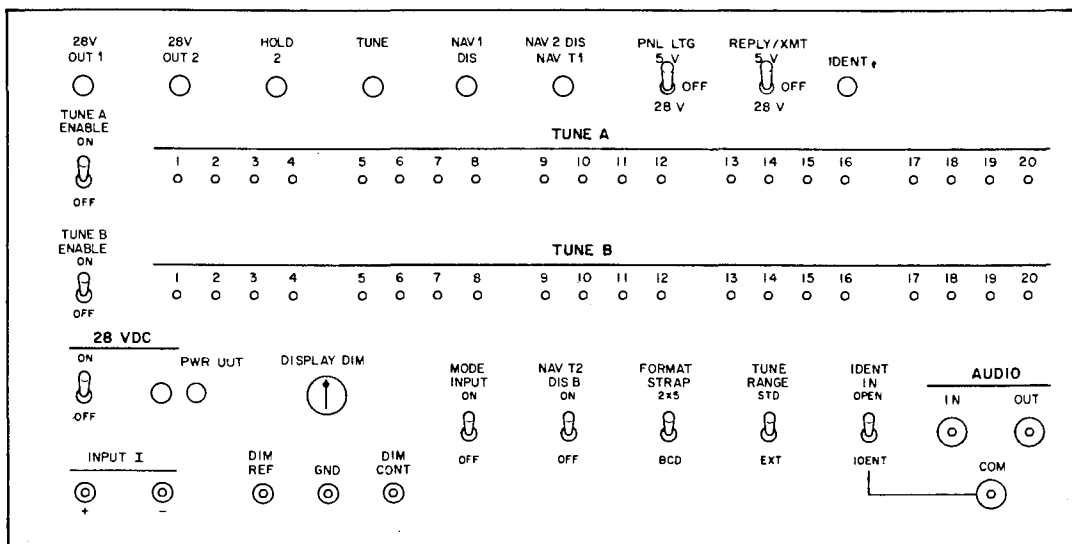

This unit is manufactured to replace the OEM model and/or part number listed below in form, fit, and function.

Equivalent OEM: Rockwell Collins

Equivalent MN: CTS-231 (ASI-289-1)

CTS-232 (ASI-289-2)

Equivalent PN: 622-5188-001 (ASI-289-1)

622-5189-001 (ASI-289-2)

Manual Figure: CTL-X0, Fig. 5-3 - 5-6 (ASI-289-1)

CTL-X0, Appendix A (ASI-289-2)

Units Tested:

CTL-20 / -21 COM Control

CTL-30 / -30R / -31 NAV / DME Control

CTL-60 / -61 ADF Control

CTL-90 / -91 ATC Transponder Control

Description of Operation:

The ASI-289 Output Monitor Test Panel is a rack mounted unit configured to test the Collins CTL-() series of controls. The ASI-289 is available in two configurations: ASI-289-1 (CTS-231) and ASI-289-2 (CTS-232).

The two panels are similar except that the ASI-289-2 provides the following functions (not provided by ASI-289-1):

1. Provides testing capability of the CTL-() NCS interface circuits (Generates NCS clock and data inputs).
2. Contains protection circuit that prevents accidental damage to CTL-() 5 volt panel and tune lights.

Specifications:

Height: 7.00 " Width: 19.00" Depth: 7.50"

Power: 28 VDC and 115 VAC 60 Hz

Equipment Supplied:

ASI MN	Equivalent PN	Description
--------	---------------	-------------

Optional Equipment:

ASI MN	Equivalent PN	Description
--------	---------------	-------------

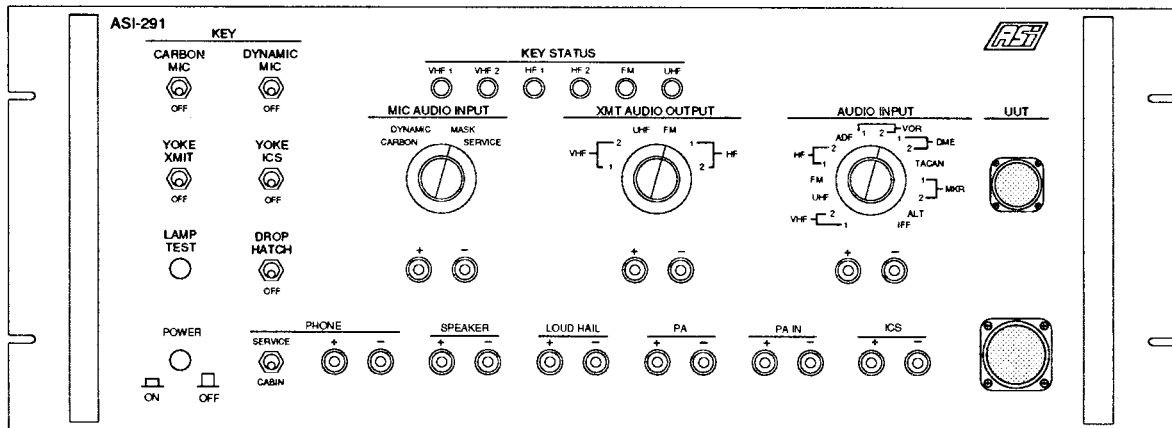

This unit is manufactured to replace the OEM model and/or part number listed below in form, fit, and function.

Equivalent OEM: Rockwell Collins
 Equivalent MN: 968J-1
 Equivalent PN: 622-4369-001
 Manual Figure:

Units Tested:
 622-4149-001 Audio Control

Description of Operation:

The ASI-291 Audio Control Test Panel is configured for the operational testing and troubleshooting of Collins 622-4149-001 Audio Controls. The Test Panel provides all switching, jacks, indicators, and connectors for testing purposes. The Test Panel also provides 5 VDC for lighting power and provides a lamp test feature for the UUT.

Interconnect cables are included with the ASI-291 and are listed below.

Specifications:

Height: 7.00" Width: 19.00" Depth: 6.00" Power: 28 VDC

Equipment Supplied:

ASI MN	Equivalent MN	Description
ASI-29-1A	634-9424-001	Cable: W1 cable assembly
ASI-29-1B	634-9425-001	Cable: W2 cable assembly

Optional Equipment:

ASI MN	Equivalent MN	Description
--------	---------------	-------------

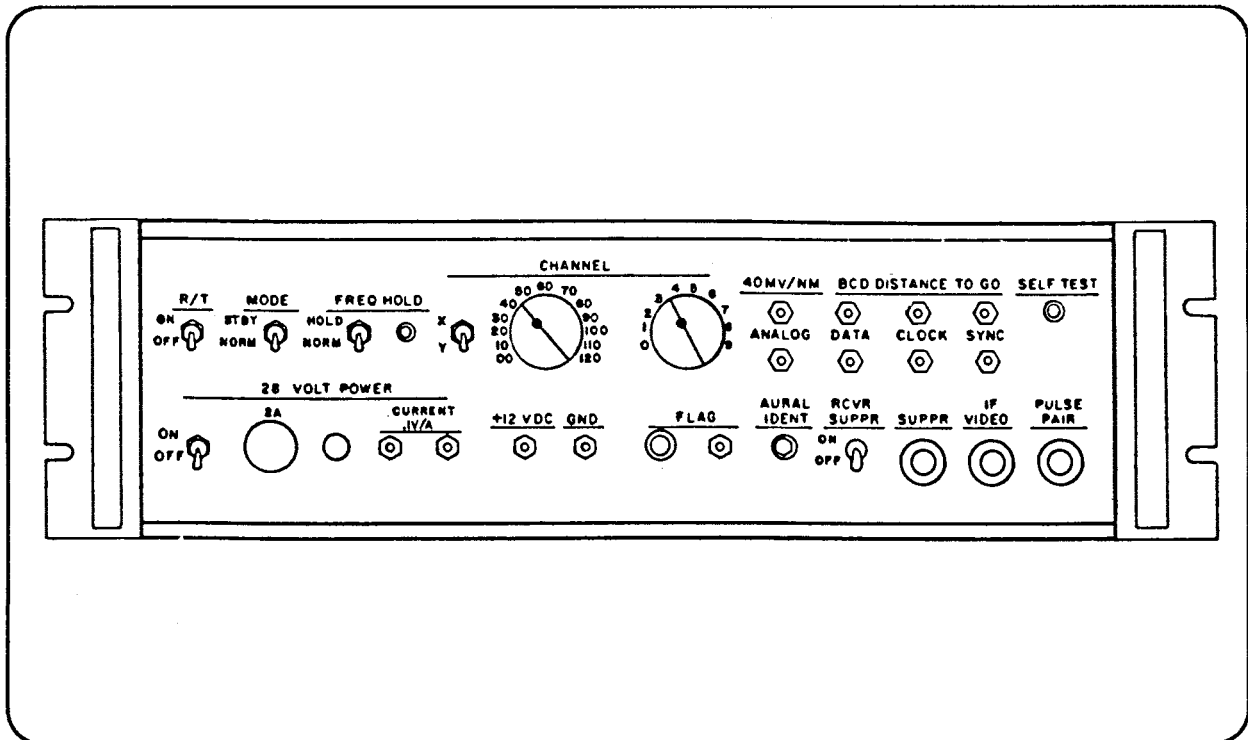

This unit is manufactured to replace the OEM model and/or part number listed below in form, fit, and function.

Equivalent OEM: Rockwell Collins
 Equivalent MN: 968W-1
 Equivalent PN: 622-4725-001
 Manual Figure:

Units Tested:
 DME-40 DME Receiver-Transmitter

Description of Operation:

The ASI-292 DME-40 Test Panel is configured for the testing, troubleshooting and alignment of the Collins DME-40 DME Receiver-Transmitter. The Test Panel provides interconnection between the UUT, a 339F-12 Indicator, a Squawk/Naut test set, and 28 VDC power by means of pendant cables. Channeling for both the Squawk/Naut and the DME-40 is provided by the ASI-292.

Specifications:

Height: 5.25" Width: 19.00" Depth: 6.00" Power: 28 VDC

Equipment Supplied:

ASI MN	Equivalent MN	Description
--------	---------------	-------------

Optional Equipment:

ASI MN	Equivalent MN	Description
--------	---------------	-------------

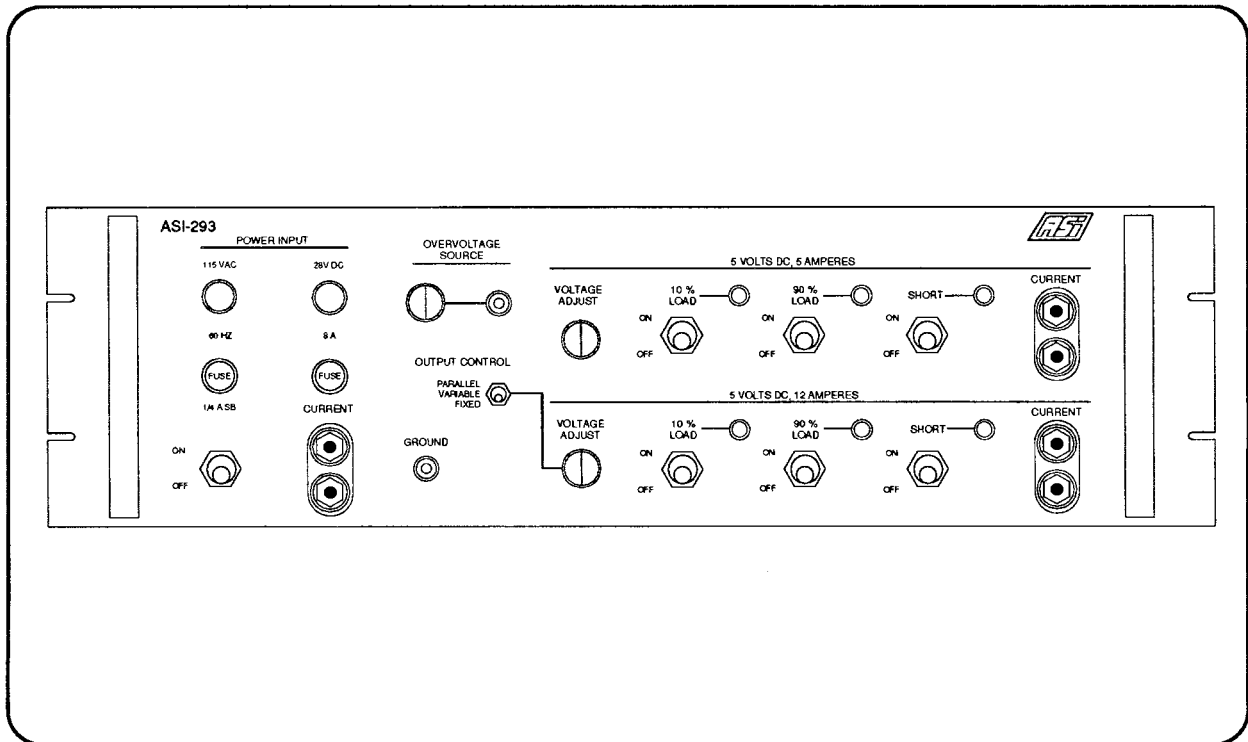

This unit is manufactured to replace the OEM model and/or part number listed below in form, fit, and function.

Equivalent OEM: Rockwell Collins
 Equivalent MN: 968X-1
 Equivalent PN: 622-4726-001
 Manual Figure:

Units Tested:
 639U-1 Lighting Power Unit

Description of Operation:

The ASI-293 Test Panel is configured to test the Collins 639U-1 Lighting Power Unit. All controls, test points, and switches necessary for testing are located on the front of the Test Panel; the UUT is connected by a pendant cable. Forced air cooling is provided for the internal circuits of the ASI-293.

Specifications:

Height: 5.25" Width: 19.00" Depth: 6.00"

Power: 115 VAC and 28 VDC

Equipment Supplied:

ASI MN	Equivalent MN	Description
--------	---------------	-------------

Optional Equipment:

ASI MN	Equivalent MN	Description
--------	---------------	-------------

Air Data Electronic Test Set		ASI-294-1												
OEM Equivalent: Rockwell Collins MN: 970D-2 PN: 622-3304-001 Manual: 523-0770593 Fig: 1-1	UUT: ADC-80() / ADC-81A / ADC-82()	Equipment Supplied: <table border="1"> <thead> <tr> <th>ASI MN</th> <th>OEM PN</th> <th>Description</th> </tr> </thead> <tbody> <tr> <td>ASI-29-4A</td> <td>638-2433-001</td> <td>Cable W1, ASI-294-1 to ADC-80/81/82</td> </tr> </tbody> </table>	ASI MN	OEM PN	Description	ASI-29-4A	638-2433-001	Cable W1, ASI-294-1 to ADC-80/81/82						
	ASI MN		OEM PN	Description										
ASI-29-4A	638-2433-001	Cable W1, ASI-294-1 to ADC-80/81/82												
Size: H: 3.90" W: 8.00" D: 12.25" Pwr: Power supplied by UUT	Description: The ASI-294-1 is used to electronically exercise the Rockwell Collins ADC-80(), ADC-81A and ADC-82() Air Data Computers and associated air data instruments. The test set simulates the air data computer pressure sensor outputs without the use of an external pressure sensor. The ASI-294-1 includes the cable required to interface the test set to the ADC-80(), ADC-81A and ADC-82(). The ASI-294-2 (970D-2A) is suggested for new applications as it has a greater testing capability than the ASI-294-1. Information on the ASI-294-2 is shown below.	Optional Equipment: <table border="1"> <thead> <tr> <th>ASI MN</th> <th>OEM PN</th> <th>Description</th> </tr> </thead> <tbody> <tr> <td>ASI-294-2</td> <td>622-8624-001</td> <td>Air Data Electronic Test Set (970D-2A)</td> </tr> <tr> <td>ASI-415-1</td> <td>622-5811-001</td> <td>Air Data Test Panel with Extenders (970D-1A)</td> </tr> <tr> <td>ASI-415-2</td> <td>622-5811-002</td> <td>Air Data Test Panel (970D-1A)</td> </tr> </tbody> </table>	ASI MN	OEM PN	Description	ASI-294-2	622-8624-001	Air Data Electronic Test Set (970D-2A)	ASI-415-1	622-5811-001	Air Data Test Panel with Extenders (970D-1A)	ASI-415-2	622-5811-002	Air Data Test Panel (970D-1A)
ASI MN	OEM PN	Description												
ASI-294-2	622-8624-001	Air Data Electronic Test Set (970D-2A)												
ASI-415-1	622-5811-001	Air Data Test Panel with Extenders (970D-1A)												
ASI-415-2	622-5811-002	Air Data Test Panel (970D-1A)												

Air Data Electronic Test Set		ASI-294-2												
OEM Equivalent: Rockwell Collins MN: 970D-2A PN: 622-8624-001 Manual: 523-0770593 Fig: 1-1	UUT: ADC-80() / ADC-81A / ADC-82() ADC-85() / ADC-86() / ADC-850()	Equipment Supplied: <table border="1"> <thead> <tr> <th>ASI MN</th> <th>OEM PN</th> <th>Description</th> </tr> </thead> <tbody> <tr> <td>ASI-29-42A</td> <td>827-6554-001</td> <td>Cable W1, ASI-294-2 to ADC-80()/81A/82()</td> </tr> <tr> <td>ASI-29-42B</td> <td>827-6554-002</td> <td>Cable W2, ASI-294-2 to ADC-85()/86()/850()</td> </tr> </tbody> </table>	ASI MN	OEM PN	Description	ASI-29-42A	827-6554-001	Cable W1, ASI-294-2 to ADC-80()/81A/82()	ASI-29-42B	827-6554-002	Cable W2, ASI-294-2 to ADC-85()/86()/850()			
	ASI MN		OEM PN	Description										
ASI-29-42A	827-6554-001	Cable W1, ASI-294-2 to ADC-80()/81A/82()												
ASI-29-42B	827-6554-002	Cable W2, ASI-294-2 to ADC-85()/86()/850()												
Size: H: 3.90" W: 8.00" D: 12.25" Pwr: Power supplied by UUT	Description: The ASI-294-2 is used to electronically exercise the Rockwell Collins ADC-80(), ADC-81A, ADC-82(), ADC-85(), ADC-86(), and ADC-850 Air Data Computers and associated air data instruments. The test set simulates the ramp signal of the ADC-80/81A/82 pressure sensor or simulates the pulse-width modulation signal of the ADC-85/86/850 pressure sensor. The ASI-294-2 also provides capability for testing dual ADC-85/86/850 air data systems. The ASI-294-2 includes the cables required to interface the test set to the ADC-80/81A/82 and ADC-85/86/850. The ASI-294-2 (970D-2A) is suggested for new applications as it has a greater testing capability than the ASI-294-1 (970D-2).	Optional Equipment: <table border="1"> <thead> <tr> <th>ASI MN</th> <th>OEM PN</th> <th>Description</th> </tr> </thead> <tbody> <tr> <td>ASI-294-1</td> <td>622-3304-001</td> <td>Air Data Electronic Test Set (970D-2)</td> </tr> <tr> <td>ASI-415-1</td> <td>622-5811-001</td> <td>Air Data Test Panel with Ext Kit (970D-1A)</td> </tr> <tr> <td>ASI-415-2</td> <td>622-5811-002</td> <td>Air Data Test Panel without Ext Kit (970D-1A)</td> </tr> </tbody> </table>	ASI MN	OEM PN	Description	ASI-294-1	622-3304-001	Air Data Electronic Test Set (970D-2)	ASI-415-1	622-5811-001	Air Data Test Panel with Ext Kit (970D-1A)	ASI-415-2	622-5811-002	Air Data Test Panel without Ext Kit (970D-1A)
ASI MN	OEM PN	Description												
ASI-294-1	622-3304-001	Air Data Electronic Test Set (970D-2)												
ASI-415-1	622-5811-001	Air Data Test Panel with Ext Kit (970D-1A)												
ASI-415-2	622-5811-002	Air Data Test Panel without Ext Kit (970D-1A)												

GPWS Test Set		ASI-295																								
OEM Equivalent: Rockwell Collins MN: 969T-1 PN: 622-3868-001 Manual: TO 33A1-3-511-1 Fig: 1-1	UUT: FPC-75	Equipment Supplied: <table border="1"> <thead> <tr> <th>ASI MN</th> <th>OEM PN</th> <th>Description</th> </tr> </thead> </table>	ASI MN	OEM PN	Description																					
	ASI MN		OEM PN	Description																						
Size: H: 8.00" W: 14.50" D: 18.00" Pwr: 115 VAC 400 Hz	Description: The ASI-295 GPWS Test Set is used for testing the troubleshooting the Rockwell Collins FPC-75 Flight Profile Comparator. The Test Set provides power and signals to the FPC-75 to simulate aircraft situations and then displays audio and /or visual indications from the uut during testing. The ASI-295 is designed for portable / ramp use. See the ASI-296-1 for a similar test set designed for test bench applications. The ASI-295 is enclosed in a portable plastic case and includes pendant cables required to interconnect the FPC-75 to the test set.	Optional Equipment: <table border="1"> <thead> <tr> <th>ASI MN</th> <th>OEM PN</th> <th>Description</th> </tr> </thead> <tbody> <tr> <td>ASI-245</td> <td>622-0147-001</td> <td>Threshold Detector (700D-2A)</td> </tr> <tr> <td>ASI-296-1</td> <td>622-2640-001</td> <td>FPC Test Set with Altitude Gen. (971T-1)</td> </tr> <tr> <td>ASI-296-2</td> <td>622-2640-002</td> <td>FPC Test Set without Altitude Gen. (971T-1)</td> </tr> <tr> <td>ASI-4920-001</td> <td>629-4920-001</td> <td>A4 Extender Card (P/O ASI-9046-001 Kit)</td> </tr> <tr> <td>ASI-4925-001</td> <td>629-4925-001</td> <td>A6 Extender Card (P/O ASI-9046-001 Kit)</td> </tr> <tr> <td>ASI-4928-001</td> <td>629-4928-001</td> <td>A5 Extender Card (P/O ASI-9046-001 Kit)</td> </tr> <tr> <td>ASI-9046-001</td> <td>629-9046-001</td> <td>FPC-75 Extender Card Kit (Includes 3 Cards)</td> </tr> </tbody> </table>	ASI MN	OEM PN	Description	ASI-245	622-0147-001	Threshold Detector (700D-2A)	ASI-296-1	622-2640-001	FPC Test Set with Altitude Gen. (971T-1)	ASI-296-2	622-2640-002	FPC Test Set without Altitude Gen. (971T-1)	ASI-4920-001	629-4920-001	A4 Extender Card (P/O ASI-9046-001 Kit)	ASI-4925-001	629-4925-001	A6 Extender Card (P/O ASI-9046-001 Kit)	ASI-4928-001	629-4928-001	A5 Extender Card (P/O ASI-9046-001 Kit)	ASI-9046-001	629-9046-001	FPC-75 Extender Card Kit (Includes 3 Cards)
ASI MN	OEM PN	Description																								
ASI-245	622-0147-001	Threshold Detector (700D-2A)																								
ASI-296-1	622-2640-001	FPC Test Set with Altitude Gen. (971T-1)																								
ASI-296-2	622-2640-002	FPC Test Set without Altitude Gen. (971T-1)																								
ASI-4920-001	629-4920-001	A4 Extender Card (P/O ASI-9046-001 Kit)																								
ASI-4925-001	629-4925-001	A6 Extender Card (P/O ASI-9046-001 Kit)																								
ASI-4928-001	629-4928-001	A5 Extender Card (P/O ASI-9046-001 Kit)																								
ASI-9046-001	629-9046-001	FPC-75 Extender Card Kit (Includes 3 Cards)																								

Flight Profile Comparator Test Set		ASI-296-1																								
OEM Equivalent: Rockwell Collins MN: 971T-1 PN: 622-2640-001 Manual: 523-0766154 Fig: 1	UUT: FPC-75	Equipment Supplied: <table border="1"> <thead> <tr> <th>ASI MN</th> <th>OEM PN</th> <th>Description</th> </tr> </thead> <tbody> <tr> <td>ASI-29-6A</td> <td>629-4898-001</td> <td>Cable W1, ASI-296-1/2 to FPC-75</td> </tr> <tr> <td>ASI-29-6B</td> <td>629-4899-001</td> <td>Cable W2, ASI-296-1/2 to FPC ATE</td> </tr> <tr> <td>ASI-19-6C</td> <td>629-4886-001</td> <td>Cable W3, ASI-296-1/2 115 VAC 400 Hz</td> </tr> <tr> <td>ASI-29-6D</td> <td>547-2795-000</td> <td>Cable W4, ASI-296-1/2 115 VAC 60 Hz</td> </tr> <tr> <td>ASI-29-6E1</td> <td>629-4851-001</td> <td>Cable, Test Point Probe Red</td> </tr> <tr> <td>ASI-29-6E2</td> <td>629-4851-002</td> <td>Cable, Test Point Probe Blk</td> </tr> <tr> <td>ASI-26-6E3</td> <td>629-4851-003</td> <td>Cable, Test Point Probe Grn</td> </tr> </tbody> </table>	ASI MN	OEM PN	Description	ASI-29-6A	629-4898-001	Cable W1, ASI-296-1/2 to FPC-75	ASI-29-6B	629-4899-001	Cable W2, ASI-296-1/2 to FPC ATE	ASI-19-6C	629-4886-001	Cable W3, ASI-296-1/2 115 VAC 400 Hz	ASI-29-6D	547-2795-000	Cable W4, ASI-296-1/2 115 VAC 60 Hz	ASI-29-6E1	629-4851-001	Cable, Test Point Probe Red	ASI-29-6E2	629-4851-002	Cable, Test Point Probe Blk	ASI-26-6E3	629-4851-003	Cable, Test Point Probe Grn
	ASI MN		OEM PN	Description																						
ASI-29-6A	629-4898-001	Cable W1, ASI-296-1/2 to FPC-75																								
ASI-29-6B	629-4899-001	Cable W2, ASI-296-1/2 to FPC ATE																								
ASI-19-6C	629-4886-001	Cable W3, ASI-296-1/2 115 VAC 400 Hz																								
ASI-29-6D	547-2795-000	Cable W4, ASI-296-1/2 115 VAC 60 Hz																								
ASI-29-6E1	629-4851-001	Cable, Test Point Probe Red																								
ASI-29-6E2	629-4851-002	Cable, Test Point Probe Blk																								
ASI-26-6E3	629-4851-003	Cable, Test Point Probe Grn																								
Size: H: 14.00" W: 19.00" D: 15.00" Pwr: 115 VAC 60 and 400 Hz	Description: The ASI-296-1 Flight Profile Comparator Test Set, when used with other standard shop equipment, provides capability to test and repair the Rockwell Collins FPC-75. Test Set develops and processes input/output signals required for testing the FPC-75 Flight Profile Comparator. The ASI-296-1 also includes synchro altitude generator functions. The ASI-296-2 (listed in the optional equipment section to the right) is identical to the ASI-296-1 except that it does not include the synchro altitude generator functions. The cables required to interface the FCP-75 to the Test Set are included.	Optional Equipment: <table border="1"> <thead> <tr> <th>ASI MN</th> <th>OEM PN</th> <th>Description</th> </tr> </thead> <tbody> <tr> <td>ASI-245</td> <td>622-0147-001</td> <td>Threshold Detector (700D-2A)</td> </tr> <tr> <td>ASI-295</td> <td>622-3868-001</td> <td>GPWS Test Set (969T-1)</td> </tr> <tr> <td>ASI-296-2</td> <td>622-2640-002</td> <td>FPC Test Set without Altitude Gen. (971T-1)</td> </tr> <tr> <td>ASI-4920-001</td> <td>629-4920-001</td> <td>A4 Extender Card (P/O ASI-9046-001 Kit)</td> </tr> <tr> <td>ASI-4925-001</td> <td>629-4925-001</td> <td>A6 Extender Card (P/O ASI-9046-001 Kit)</td> </tr> <tr> <td>ASI-4928-001</td> <td>629-4928-001</td> <td>A5 Extender Card (P/O ASI-9046-001 Kit)</td> </tr> <tr> <td>ASI-9046-001</td> <td>629-9046-001</td> <td>FPC-75 Extender Card Kit (Includes 3 Cards)</td> </tr> </tbody> </table>	ASI MN	OEM PN	Description	ASI-245	622-0147-001	Threshold Detector (700D-2A)	ASI-295	622-3868-001	GPWS Test Set (969T-1)	ASI-296-2	622-2640-002	FPC Test Set without Altitude Gen. (971T-1)	ASI-4920-001	629-4920-001	A4 Extender Card (P/O ASI-9046-001 Kit)	ASI-4925-001	629-4925-001	A6 Extender Card (P/O ASI-9046-001 Kit)	ASI-4928-001	629-4928-001	A5 Extender Card (P/O ASI-9046-001 Kit)	ASI-9046-001	629-9046-001	FPC-75 Extender Card Kit (Includes 3 Cards)
ASI MN	OEM PN	Description																								
ASI-245	622-0147-001	Threshold Detector (700D-2A)																								
ASI-295	622-3868-001	GPWS Test Set (969T-1)																								
ASI-296-2	622-2640-002	FPC Test Set without Altitude Gen. (971T-1)																								
ASI-4920-001	629-4920-001	A4 Extender Card (P/O ASI-9046-001 Kit)																								
ASI-4925-001	629-4925-001	A6 Extender Card (P/O ASI-9046-001 Kit)																								
ASI-4928-001	629-4928-001	A5 Extender Card (P/O ASI-9046-001 Kit)																								
ASI-9046-001	629-9046-001	FPC-75 Extender Card Kit (Includes 3 Cards)																								

R1

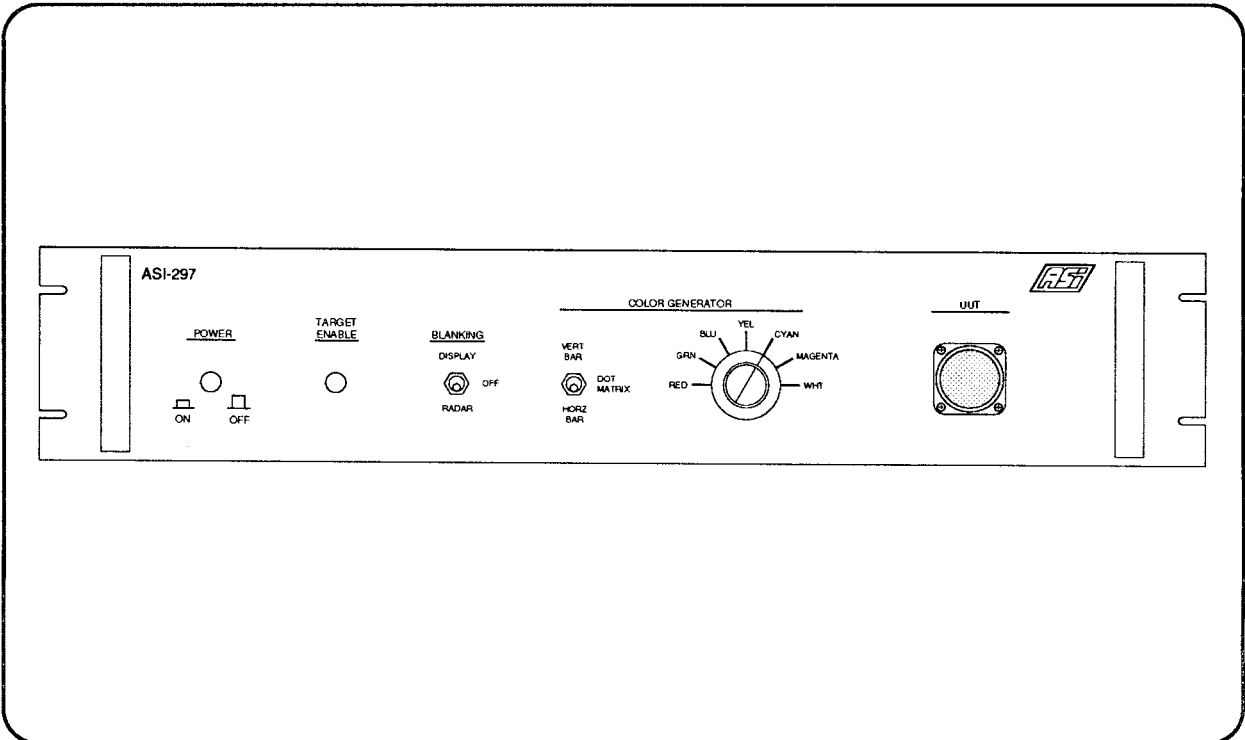

This unit is manufactured to replace the OEM model and/or part number listed below in form, fit, and function.

Equivalent OEM: Rockwell Collins
 Equivalent MN: CTS-300
 Equivalent PN: 622-4946-001
 Manual Figure:

Units Tested:
 IND-300 Weather Radar Indicator

Description of Operation:

The ASI-297 Generator Test Set is configured to generate color test patterns for such indicators as the IND-300 Weather Radar Indicator. The patterns include dots or bars and can be selected in one of seven colors. A cable is provided for interconnection between the ASI-297 and the indicator.

Specifications:

Height: 3.50" Width: 19.00" Depth: 9.60" Power: 28 VDC

Equipment Supplied:

ASI MN	Equivalent PN	Description
ASI-29-7A	634-9296-001	Cable: ASI-297 to IND-300

Optional Equipment:

ASI MN	Equivalent PN	Description
--------	---------------	-------------

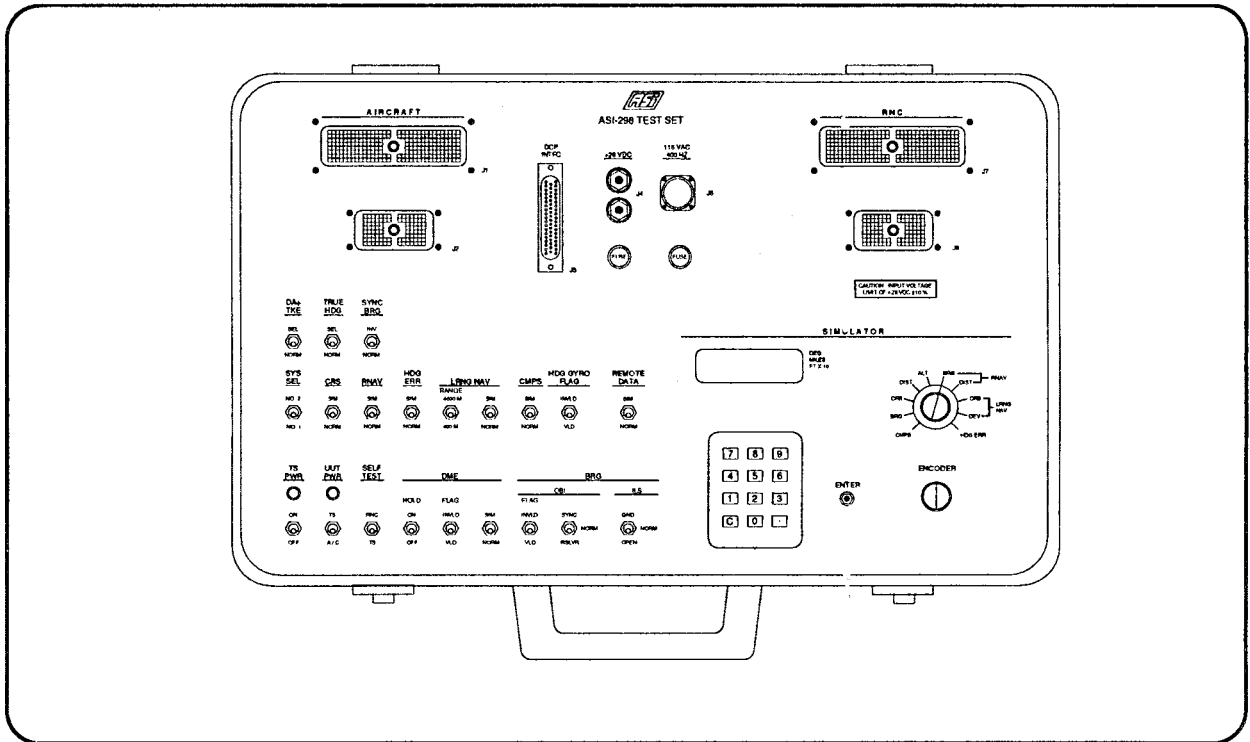

This unit is manufactured to replace the OEM model and/or part number listed below in form, fit, and function.

Equivalent OEM: Rockwell Collins
 Equivalent MN: CTS-301
 Equivalent PN: 622-5225-001
 Manual Figure:

Units Tested:
 RNS-300() Radar Navigation System

Description of Operation:

The ASI-298 Radar NAV Test Set is a portable unit configured to test the RNS-300() Radar Navigation System on the bench or in the aircraft. The Test Set provides all signals and switching needed to test each of the operating modes of the RNS-300() system, one side at a time. The ASI-298 is programmed to provide two sets of preset input conditions, one for the No. 1 side and the other for the No. 2 side. This information may be changed manually to provide any combination of navigational situations within the range of the RNS-300() operating parameters.

The ASI-298 comes complete with interconnect cables and is housed in a rugged suitcase container.

Specifications:

Height: 13.30" Width: 21.30" Depth: 5.00"

Power: 28 VDC and 115 VAC 400 Hz

Equipment Supplied:

ASI MN	Equivalent PN	Description
ASI-29-8A	634-9782-001	Cable: ASI-298 to RNC-300() mount (in-aircraft test, W1)
ASI-29-8B	634-9783-001	Cable: ASI-298 to RNC-300() (in-aircraft or bench test, W2)
ASI-29-8C	634-9784-001	Cable: ASI-298 to DCP-320 / 325 (bench test only, W3)
ASI-29-8D	634-9785-001	Cable: DCP-320 / 325 to Indicator (in-aircraft or bench test, W4)
ASI-29-8E	634-9786-001	Cable: 115 VAC Power (bench test only, W5)
ASI-29-8F	634-9845-001	Cable: 28VDC to Indicator (allows operation without WXR-250A Radar R / T, W7)

Optional Equipment:

ASI MN	Equivalent PN	Description
ASI-297	622-9296-001	Generator Test Set (used for alignment of IND-300 Indicator)

ALT Test Panel

ASI-299

OEM Equivalent: Rockwell Collins MN: NMN PN: 828-8249-001 Manual: 523-0777844 Manual Figure: 901-902	UUT: ALT-55B / ALT-1000 / ALT-4000 ALI-55 / DRI-55 Size: H: 5.25" W: 19.00" D: 6.00" Pwr: 28 VDC
--	---

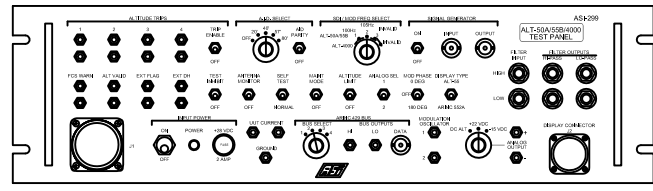

Description:
The ASI-299 ALT Test Panel provides capability to test and repair the Collins ALT-1000, ALT-4000, and ALT-55B Radio Altimeter R/T units. The ASI-299 provides power, test points, discretes, monitoring, and interconnection required for testing.

The ASI-299 works in conjunction with the Collins CTC-429 CSDB/ARINC interface card (822-0854-001), ISA computer, and the ASI-29-9G BITE interface cable to provide computer controlled testing of the ALT-4000. The Avionics GP-429 ARINC 429 interface module may be substituted in place of the Collins CTC-429 CSDB/ARINC interface card. For this application the ASI-29-9J BITE interface cable must be used instead of the ASI-29-9G. The ALT-4000 BITE Interface disk (831-4676-00x) must be purchased directly from Collins in order to ensure latest revision of the test software.

Test Software:
831-4676-00x ALT-4000 BITE Test Program

Optional Equipment:

ASI MN	OEM PN	Description
ASI-29-9C	NPN	DIR-55 Cable (For Use With ALT-55 and ALT-4000)
ASI-29-9D	NPN	ALT-50A-55B Pre-Amp Test Fixture (Restricted)
ASI-29-9E	NPN	ALT-4000 Digital Circuit Card Ext. Cable
ASI-29-9F	NPN	ALT-4000 Digital to XMTR Card Ext. Cable
ASI-29-9G	NPN	ALT-4000 BITE Interface Cable (CTC-429)
ASI-29-9H	NPN	ALT-4000 Digital Card Coaxial Ext. Cable
ASI-29-9J	NPN	ALT-4000 BITE Interface Cable (GP-429)
ASI-29-9K	(Qty 2 Required)	ALT-50A-55B/860F-2 Special 13'-2" RF Test Cable
ASI-299-1	NPN	ALT-50A-55B/860F-2 XMTR/MOD Test Fixture
ASI-299-2	618-1673-002	ALT-50A-55B/860F-2 XMTR Dust Cover Fixture

Equipment Supplied:

ASI MN	OEM PN	Description
ASI-29-9A	NPN	Cable, ASI-299 to ALT-4000/50A-55B/860F-2
ASI-29-9B	NPN	Cable, ASI-299 to ALI-55/339H-4
ASI-29-9C1	NPN	Cable, ASI-299 to DRI-55 (Use With ALT-55B)
ASI-29-9C2	NPN	Cable, ASI-299 to DRI-55 (Use With ALT-4000)

Radio Test Set

ASI-300

OEM Equivalent: Rockwell Collins MN: 973W-2 PN: 622-5058-001 Manual: 523-0772568 / 523-0770438 Manual Figure: 1	UUT: AN/ARC-182(V) System 628B-1() / 628U-2/11 / RT-1250() RT-1324A/-1327A/-1360A/-1407/-1629 379F-1() / C-10319A/-10776A/-11131 ID-2121A/-2229A/-2303 Size: H: 4.50" W: 12.00" D: 8.00" Pwr: 28 VDC
---	---

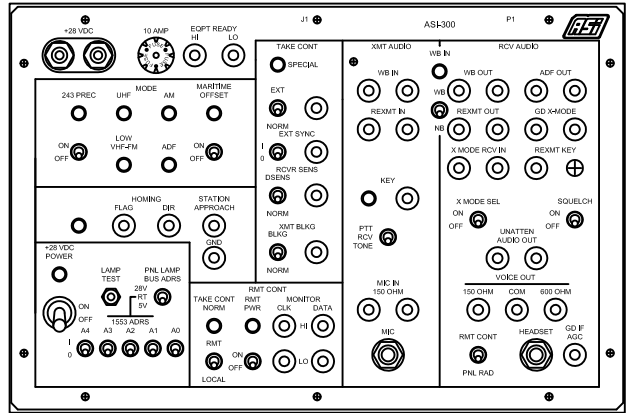

Description:
The ASI-300 works in conjunction with an external MIL-STD-1553B Source and standard test equipment to provide manual intermediate and operational level maintenance for the Collins AN/ARC-182(V) UHF/VHF Communications System.

The ASI-300 test set is used for testing standard AN/ARC-182(V) units in operational modes. The test set includes test points, indicators, and switches to measure and monitor all major functions. It operates from 28 VDC power supply and supplies power to the units under test.

The test set includes pendant cable required for interconnection of the receiver-transmitter and an adapter cable (ASI-30-0A) for the control and indicator.

Optional Equipment:

ASI MN	OEM PN	Description
ASI-30-0A	642-2511-001	Adapter Cable, Control / Indicator
ASI-30-1K	NPN	Microphone Simulator

Radio Test Set

ASI-301

OEM Equivalent: Rockwell Collins MN: 973W-3 PN: 622-6121-001 Manual: 523-0772568 / 523-0774920 Manual Figure: 1	UUT: AN/ARC-182(V) System 628B-1() / 628U-1/2/11 / RT-1250() RT-1324A/-1327A/-1360A/-1407/-1629 379F-1() / C-10319A/-10776A/-11131 C-12036 / ID-2121A/-2229A/-2303 Size: H: 7.00" W: 19.00" D: 13.00" Pwr: 28 VDC
---	--

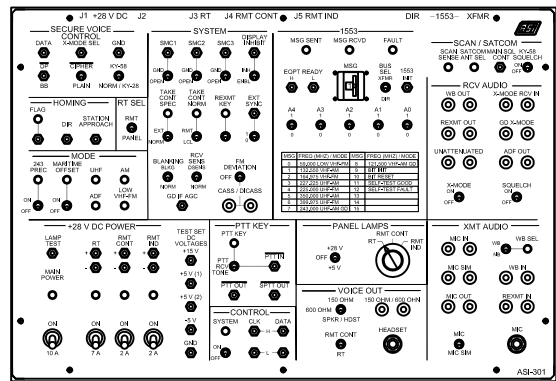

Description:
The ASI-301 works in conjunction with standard test equipment to provide manual intermediate and operational level maintenance for the Collins AN/ARC-182(V) UHF/VHF Communications System.

The ASI-301 test set is used for testing AN/ARC-182(V) units in all operational modes including SCAN/SATCOM series, CASS/DICASS, and embedded HAVE QUICK units. The test set includes several built-in MIL-STD-1553B messages, as well as test points, indicators, and switches to measure and monitor all major functions. It operates from 28 VDC power supply and supplies power to the units under test.

Equipment Supplied:

ASI MN	OEM PN	Description
ASI-30-1A	751-1767-001	Cable, Receiver-Transmitter (W1)
ASI-30-1B	751-1767-002	Cable, Remote Control (W2)
ASI-30-1C	751-1767-003	Cable, Remote Indicator (W3)
ASI-30-1D	751-1766-001	Cable, 1553 DIR (W4)
ASI-30-1E	751-1766-002	Cable, 1553 XMFR (W5)
ASI-30-1F	751-1765-001	Cable, 28 VDC Power (W6)
ASI-30-1G	751-1762-001	Cable, RF (W7)
ASI-30-1H	751-8272-001	Cable, Remote Control (W8)
ASI-30-1J	217-0166-010	Microphone

Optional Equipment:

ASI MN	OEM PN	Description
ASI-30-1K	NPN	Microphone Simulator

Audio Test Fixture		ASI-321A		
OEM Equivalent: Rockwell Collins MN: 969N-1A PN: 622-5532-001 Manual: 523-0771233 Fig: 1-1	UUT: 719S-1 / 719S-3 / RT-980 / RT-1369 Size: H: 2.00" W: 9.00" D: 7.00" Pwr: From UUT	Equipment Supplied:		
		<u>ASI MN</u>	<u>OEM PN</u>	<u>Description</u>
Description: The ASI-321A provides convenient test points and loading required for monitoring and testing audio signal circuit operation for various Receiver-Transmitters of the AN/GRC-171(V)1 and AN/GRC-211 (VHF-400) Communication Systems.		Optional Equipment:		
		<u>ASI MN</u>	<u>OEM PN</u>	<u>Description</u>
		ASI-310	622-5731-001	Maintenance Extender Kit (438K-2)
		ASI-310-2C	622-9663-001	Maintenance Extender Kit (438K-2C)
Audio Test Fixture		ASI-321B		
OEM Equivalent: Rockwell Collins MN: 969N-1B PN: 622-5655-001 Manual: 523-0771233 Fig: 1-2	UUT: RT-1272 Size: H: 2.00" W: 9.00" D: 7.00" Pwr: From UUT	Equipment Supplied:		
		<u>ASI MN</u>	<u>OEM PN</u>	<u>Description</u>
Description: The ASI-321B provides convenient test points and loading required for monitoring and testing audio signal circuit operation for various Receiver-Transmitters of the AN/GRC-171(V)2 Communication System.		Optional Equipment:		
		<u>ASI MN</u>	<u>OEM PN</u>	<u>Description</u>
		ASI-310	622-5731-001	Maintenance Extender Kit (438K-2)
		ASI-310-2C	622-9663-001	Maintenance Extender Kit (438K-2C)
		ASI-321D	622-8014-001	Audio Test Fixture (969N-1D)
Audio Test Fixture		ASI-321D		
OEM Equivalent: Rockwell Collins MN: 969N-1D PN: 622-8014-001 Manual: 523-0775632 Fig: 1-1	UUT: RT-1272 / RT-1272D Size: H: 3.00" W: 13.00" D: 9.50" Pwr: From UUT	Equipment Supplied:		
		<u>ASI MN</u>	<u>OEM PN</u>	<u>Description</u>
Description: The ASI-321D provides convenient test points and loading required for monitoring and testing audio signal circuit operation for various Receiver-Transmitters of the AN/GRC-171(V)2 and AN/GRC-171(V)4 Communication Systems. The ASI-321D can be used in place of the ASI-321B (969N-1B)		Optional Equipment:		
		<u>ASI MN</u>	<u>OEM PN</u>	<u>Description</u>
		ASI-310	622-5731-001	Maintenance Extender Kit (438K-2)
		ASI-310-2C	622-9663-001	Maintenance Extender Kit (438K-2C)
Radio Set Test Panel		ASI-323-21		
OEM Equivalent: Rockwell Collins MN: 966D-5A PN: 622-7574-002 Manual: 523-0772741 Fig: 1-2	UUT: AN/ARC-190(V) System RT-1341(V) C-10828(V) / C-11443 CU-2275(V) / CU-2314(V) C-11814 / 514A-12 / 514A-13 CP-2024 / 309L-4 / 309M-1	Equipment Supplied:		
Size: H: 15.75" W: 19.00" D: 13.50" Pwr: 115 VAC 400 Hz		<u>ASI MN</u>	<u>OEM PN</u>	<u>Description</u>
Description: The ASI-323-21 Radio Set Test Panel provides capability for intermediate and overhaul level testing of the AN/ARC-190(V) HF Communication System in a hot mockup test bench configuration. The Test Panel provides power, controls and indicators for manual test and fault isolation to the circuit card and component level in the radio set control and receiver-transmitter.		ASI-32-3A	651-3120-001	Cable W1: Power
Testing the 309L-3, 309M-1, CP-2024, C-11814 and 514A-12/13 requires optional ASI-602-X (966D-18) Selscan Interface Test Set with appropriate 964B-X adapter.		ASI-32-3B	651-3121-001	Cable W2: R/T
The ASI-323-3 is an upgraded version of the ASI-323-21 that adds capability to test the various components of the HF-190 System.		ASI-32-3C	651-3122-002	Cable W3: Coupler
		ASI-32-3D	651-3123-001	Cable W4: R/T
		ASI-32-3E	651-3967-001	Cable W8: Preselector
		ASI-323-4	647-7983-001	Extender Kit for Radio Set Control
		ASI-32-34A	647-2693-001	Extender W1 (P/O ASI-323-4)
		ASI-32-34B	647-2694-001	Extender W2 (P/O ASI-323-4)
		ASI-32-34C	651-3410-001	Extender W3 (P/O ASI-323-4)
		Optional Equipment:		
		<u>ASI MN</u>	<u>OEM PN</u>	<u>Description</u>
		ASI-32-3G	NPN	Dummy Audio Plug
		ASI-207-1	622-0180-001	Dummy Antenna Shunt (172H-18)
		ASI-323-3	622-9034-001	Radio Set Test Panel (966D-5B)
		ASI-329-4	522-1248-004	Electrical Dummy Load (DA-174/GRM-10)
		ASI-329-5	522-1249-004	Electrical Dummy Load (DA-175/GRM-10)
		ASI-329-6	522-1247-002	Electrical Dummy Load (DA-173/GRM-10)
		ASI-602-1	622-7340-001	Selscan Interface with 964B-1 (966D-18)
		ASI-602-2	622-7340-002	Selscan Interface with 964B-2 (966D-18)
		ASI-602-3	622-7340-003	Selscan Interface with 964B-3 (966D-18)
Radio Set Test Panel		ASI-323-3		
OEM Equivalent: Rockwell Collins MN: 966D-5B PN: 622-9034-001 Manual: 523-0772741 Fig: 1-3	UUT: AN/ARC-190(V) / HF-190 Systems RT-1341(V) / 728U-2 / 728U-4 C-10828(V) / C-11443 / C-11814 514A-8 / 514A-9 / 514A-12 / 514A-13 CU-2275(V) / CU-2314(V) 490A-1 / 490A-2 / 490A-5 / 490S-4 CP-2024 / 309L-4 / 309M-1	Equipment Supplied:		
Size: H: 15.75" W: 19.00" D: 15.50" Pwr: 115 VAC 400 Hz		<u>ASI MN</u>	<u>OEM PN</u>	<u>Description</u>
Description: The ASI-323-3 Radio Set Test Panel provides capability for intermediate and overhaul level testing of the AN/ARC-190(V) / HF-190 HF Communication Systems in a hot mockup test bench configuration. The Test Panel provides power, controls and indicators for manual test and fault isolation to the circuit card and component level in the radio set control and receiver-transmitter.		ASI-32-3A	651-3120-001	Cable W1: Power
Testing the 309L-3, 309M-1, CP-2024, C-11814 and 514A-12/13 requires optional ASI-602-X (966D-18) Selscan Interface Test Set with appropriate 964B-X adapter.		ASI-32-3B1	751-2269-001	Cable W2: R/T
The ASI-323-3 is an upgraded version of the ASI-323-21 that adds capability to test the various components of the HF-190 System.		ASI-32-3C	651-3122-002	Cable W3: Coupler
		ASI-32-3D	651-3123-001	Cable W4: R/T
		ASI-32-3E	651-3967-001	Cable W8: Preselector
		ASI-32-3F	751-2241-001	Cable W9: Electronic
		ASI-323-31	751-2239-001	966D-5B Adapter A7
		ASI-323-4	647-7983-001	Extender Kit for Radio Set Control
		ASI-32-34A	647-2693-001	Extender W1 (P/O ASI-323-4)
		ASI-32-34B	647-2694-001	Extender W2 (P/O ASI-323-4)
		ASI-32-34C	651-3410-001	Extender W3 (P/O ASI-323-4)
		Optional Equipment:		
		<u>ASI MN</u>	<u>OEM PN</u>	<u>Description</u>
		ASI-32-3G	NPN	Dummy Audio Plug
		ASI-207-1	622-0180-001	Dummy Antenna Shunt (172H-18)
		ASI-329-4	522-1248-004	Electrical Dummy Load (DA-174/GRM-10)
		ASI-329-5	522-1249-004	Electrical Dummy Load (DA-175/GRM-10)
		ASI-329-6	522-1247-002	Electrical Dummy Load (DA-173/GRM-10)
		ASI-602-1	622-7340-001	Selscan Interface with 964B-1 (966D-18)
		ASI-602-2	622-7340-002	Selscan Interface with 964B-2 (966D-18)
		ASI-602-3	622-7340-003	Selscan Interface with 964B-3 (966D-18)

Antenna Coupler Test Set

ASI-328

Description of Operation:

The ASI-328 is used to test the modules of the Collins 490T-1/1A/2/2A/4/9 Antenna Couplers.

Equivalent OEM: Collins

Equivalent MN: 980H-1

Equivalent PN: 522-4380-001

Units Tested:

490T-1/1A, 490T-2/2A

490T-4, 490T-9

The ASI-328 includes the ASI-328-1 Antenna Coupler Control Tester, ASI-328-2 Electronics Control Amplifier Tester, ASI-328-3 Discriminator Tester, and ASI-328-4 Power Panel, enclosed in a rugged case.

Equipment Supplied:

ASI-328-1	Antenna Coupler Control Tester (878L-15)
ASI-328-2	Electronic Control Amplifier Tester (878L-16)
ASI-328-3	Discriminator Tester (878L-17)
ASI-328-4	Power Panel (761-4599-001)
ASI-32-8A	A1 Extender (637-1902-001)
ASI-32-8B	A3 Extender (637-1904-001)
ASI-32-81A	W2 Cable (761-4400-001)
ASI-32-82A	W3 Cable (554-6957-001)
ASI-32-83A	W4 Cable (554-6958-001)
ASI-32-84A	W1 Cable (761-4600-001)

Equipment Specifications:

Height: 24.50" Width: 22.00" Depth: 24.50"

Antenna Coupler Control Tester

ASI-328-1

Description of Operation:

The ASI-328-1 contains power supply and switching matrix necessary to energize control circuits in the antenna coupler module under test.

Equivalent OEM: Collins

Equivalent MN: 878L-15

Equivalent PN: 522-4252-001

Units Tested:

490T-1/1A, 490T-2/2A

490T-4, 490T-9

The ASI-328-1 employs lamp comparison and voltage test points for a go/no-go test of the coupler module.

Equipment Supplied:

ASI-32-81A W2 Cable (761-4400-001)

Equipment Specifications:

Height: 8.75" Width: 19.00" Depth: 5.750"

Electronic Control Amplifier Tester

ASI-328-2

Description of Operation:

The ASI-328-2 provides inputs necessary to operate the electronic control amplifier module.

Equivalent OEM: Collins

Equivalent MN: 878L-16

Equivalent PN: 522-4253-001

Units Tested:

490T-1/1A, 490T-2/2A

490T-4, 490T-9

The ASI-328-2 employs lamp comparison and torque meter indications for a go/no-go test of the electronic control amplifier module.

Equipment Supplied:

ASI-32-82A W3 Cable (554-6957-001)

Equipment Specifications:

Height: 5.25" Width: 19.00" Depth: 4.875"

Discriminator Tester

ASI-328-3

Description of Operation:

The ASI-328-3 simulates actual operating condition under which the discriminator module operates in the antenna coupler.

Equivalent OEM: Collins

Equivalent MN: 878L-17

Equivalent PN: 522-4254-001

Units Tested:

490T-1/1A, 490T-2/2A

490T-4, 490T-9

The discriminator error signals are monitored by a meter on the front panel of the ASI-328-3

Equipment Supplied:

ASI-32-83A W4 Cable (554-6958-001)

Equipment Specifications:

Height: 5.25" Width: 19.00" Depth: 7.125"

Power Panel

ASI-328-4

Description of Operation:

The ASI-328-4 Power Panel controls AC power input into the ASI-328.

Equivalent OEM: Collins

Equivalent MN:

Equivalent PN: 761-4599-001

Units Tested:

Power input is supplied through the W1 cable (ASI-32-8A).

Equipment Supplied:

ASI-32-84A W1 Cable (761-4600-001)

Equipment Specifications:

Height: 1.75" Width: 19.00" Depth: 2.00"

1-1-97

Electrical Dummy Load		ASI-329-1		
OEM Equivalent: Rockwell Collins MN: 172H-8 PN: 522-4514-001 Manual: 523-0758777 Figure: 1-1	UUT: 490T-1/-1A/-2/-2A/-2B/-9 / CU-1658/A	Equipment Supplied:		
	Size: H: 7.25" W: 9.25" D: 13.75" Pwr: 115 VAC 400 Hz	<u>ASI MN</u>	<u>OEM PN</u>	<u>Description</u>
Description: The ASI-329-1 Electrical Dummy Load is used in conjunction with other test equipment for testing, adjusting, or troubleshooting the 490T-() Antenna Coupler. The ASI-329-1 simulates an aircraft 85 foot long-wire hf antenna or a 437R-1 Helical Monopole Loading Coil and can be used with antenna coupler systems rated up to 500 watts average power.		Optional Equipment:		
		<u>ASI MN</u>	<u>OEM PN</u>	<u>Description</u>
		ASI-328	522-4380-001	Antenna Coupler Test Set (980H-1)
		ASI-328-1	522-4252-001	Antenna Coupler Control Tester (878L-15)
		ASI-328-2	522-4253-001	Electronic Control Amplifier Tester (878L-16)
		ASI-328-3	522-4254-001	Discriminator Tester (878L-17)
		ASI-328-4	761-4599-001	Power Panel
Electrical Dummy Load		ASI-329-1A		
OEM Equivalent: Rockwell Collins MN: 172H-8 PN: 522-4514-002 Manual: 523-0758777 Figure: 1-1	UUT: 490T-1/-1A/-2/-2A/-2B/-9 / CU-1658/A	Equipment Supplied:		
	Size: H: 7.25" W: 9.25" D: 13.75" Pwr: 115 VAC 60 Hz	<u>ASI MN</u>	<u>OEM PN</u>	<u>Description</u>
Description: The ASI-329-1A Electrical Dummy Load is used in conjunction with other test equipment for testing, adjusting, or troubleshooting the 490T-() Antenna Coupler. The ASI-329-1A simulates an aircraft 85 foot long-wire hf antenna or a 437R-1 Helical Monopole Loading Coil and can be used with antenna coupler systems rated up to 500 watts average power.		Optional Equipment:		
		<u>ASI MN</u>	<u>OEM PN</u>	<u>Description</u>
		ASI-328	522-4380-001	Antenna Coupler Test Set (980H-1)
		ASI-328-1	522-4252-001	Antenna Coupler Control Tester (878L-15)
		ASI-328-2	522-4253-001	Electronic Control Amplifier Tester (878L-16)
		ASI-328-3	522-4254-001	Discriminator Tester (878L-17)
		ASI-328-4	761-4599-001	Power Panel
Electrical Dummy Load		ASI-329-1B		
OEM Equivalent: Rockwell Collins MN: DA-487/U PN: 522-4514-001 Man: TM11-5985-327-15 Fig: 1-1	UUT: 490T-1/-1A/-2/-2A/-2B/-9 / CU-1658/A	Equipment Supplied:		
	Size: H: 7.25" W: 9.25" D: 13.75" Pwr: 115 VAC 400 Hz	<u>ASI MN</u>	<u>OEM PN</u>	<u>Description</u>
Description: The ASI-329-1B Electrical Dummy Load is used in conjunction with other test equipment for testing, adjusting, or troubleshooting the CU-1658/A Antenna Coupler. The ASI-329-1B simulates an aircraft 85 foot long-wire hf antenna or a 437R-1 Helical Monopole Loading Coil and can be used with antenna coupler systems rated up to 500 watts average power. The ASI-329-1B is identical to the ASI-329-1.		Optional Equipment:		
		<u>ASI MN</u>	<u>OEM PN</u>	<u>Description</u>
		ASI-328	522-4380-001	Antenna Coupler Test Set (980H-1)
		ASI-328-1	522-4252-001	Antenna Coupler Control Tester (878L-15)
		ASI-328-2	522-4253-001	Electronic Control Amplifier Tester (878L-16)
		ASI-328-3	522-4254-001	Discriminator Tester (878L-17)
		ASI-328-4	761-4599-001	Power Panel
Electrical Dummy Load		ASI-329-1C		
OEM Equivalent: Rockwell Collins MN: 172H-8A PN: 642-2190-001 Manual:	UUT: CU-2041/AR	Equipment Supplied:		
	Size: H: 7.25" W: 9.25" D: 13.75" Pwr: 115 VAC 60 Hz	<u>ASI MN</u>	<u>OEM PN</u>	<u>Description</u>
Description: The ASI-329-1C Electrical Dummy Load is used in conjunction with other test equipment for testing, adjusting, or troubleshooting the CU-2041/AR Ant Coupler. The ASI-329-1C simulates an aircraft 85 foot long-wire hf antenna or a 437R-1 Helical Monopole Loading Coil and can be used with antenna coupler systems rated up to 500 watts average power.		Optional Equipment:		
		<u>ASI MN</u>	<u>OEM PN</u>	<u>Description</u>
		ASI-328	522-4380-001	Antenna Coupler Test Set (980H-1)
		ASI-328-1	522-4252-001	Antenna Coupler Control Tester (878L-15)
		ASI-328-2	522-4253-001	Electronic Control Amplifier Tester (878L-16)
		ASI-328-3	522-4254-001	Discriminator Tester (878L-17)
		ASI-328-4	761-4599-001	Power Panel
Dummy Composite Antenna		ASI-329-2		
OEM Equivalent: Rockwell Collins MN: 172H-1 PN: 522-1708-000 Manual: 523-0001000 Figure: 1	UUT: 180R-4/-6/-7/-8/-10	Equipment Supplied:		
	Size: H: 10.50" W: 9.00" D: 15.00" Pwr: 115 VAC 60 Hz	<u>ASI MN</u>	<u>OEM PN</u>	<u>Description</u>
Description: The ASI-329-2 Dummy Composite Antenna is used in conjunction with other test equipment for testing, adjusting, or troubleshooting the 180R-() Antenna Coupler. The ASI-329-2 simulates the high Q points of various tail-cap antennas. The ASI-329-2 (172H-1) is interchangeable with the ASI-329-13 (172H-26).		Optional Equipment:		
		<u>ASI MN</u>	<u>OEM PN</u>	<u>Description</u>
		ASI-346	522-4748-001	Antenna Coupler Test Set (980H-3)
		ASI-346-1	522-3022-000	Amplifier Test Set (878L-1)
		ASI-346-2	522-3271-000	Relay Control Test Set (878L-2)
		ASI-246-3	522-3272-000	Discriminator Tester (878L-3)
		ASI-346-4	772-6871-001	Power Panel
Shunt Dummy Antenna		ASI-329-3		
OEM Equivalent: Rockwell Collins MN: 172H-18A PN: 622-7148-001 Manual: 523-0776293 Figure: 1-1	UUT: 490S-1 / 490S-4 / CU-2314(V)1/-2/-3/-4 CPL-920D / HF-9040 / HF-9041 / HF-9042	Equipment Supplied:		
	Size: H: 7.25" W: 9.25" D: 13.75" Pwr: 115 VAC 60 Hz	<u>ASI MN</u>	<u>OEM PN</u>	<u>Description</u>
Description: The ASI-329-3 Shunt Dummy Antenna is used in conjunction with other test equipment for testing, adjusting, or troubleshooting the CPL-920D, 490S-4, CU-2314(V) ()/ARC-190, HF-9040, HF-9041, and HF-9042 Antenna Couplers. The ASI-329-3 simulates an hf shunt type aircraft antenna for use with radio systems rated up to 200 watts average and 630 watts peak envelope power (pep)		Optional Equipment:		
		<u>ASI MN</u>	<u>OEM PN</u>	<u>Description</u>
		ASI-207-1	622-0180-001	Shunt Dummy Antenna (172H-18)
		ASI-207-3		RF High Voltage Fixture for CPL-920D
		ASI-207-13	652-2443-001	Coaxial Adapter
		ASI-329-31		Test RF Feedline for CU-2314(V)1/ARC-190
		ASI-329-32		Test RF Feedline for CU-2314(V)2/ARC-190
		ASI-329-33		Test RF Feedline for CU-2314(V)3/ARC-190
		ASI-329-34		Test RF Feedline for CU-2314(V)4/ARC-190 R1

Electrical Dummy Load		ASI-329-1	
OEM Equivalent: Rockwell Collins MN: 172H-8 PN: 522-4514-001 Manual: 523-0758777 Figure: 1-1	UUT: 490T-1/-1A/-2/-2A/-2B/-9 / CU-1658/A Size: H: 7.25" W: 9.25" D: 13.75" Pwr: 115 VAC 400 Hz	Equipment Supplied: <u>ASI MN</u> <u>OEM PN</u> <u>Description</u>	
Description: The ASI-329-1 Electrical Dummy Load is used in conjunction with other test equipment for testing, adjusting, or troubleshooting the 490T-() Antenna Coupler. The ASI-329-1 simulates an aircraft 85 foot long-wire hf antenna or a 437R-1 Helical Monopole Loading Coil and can be used with antenna coupler systems rated up to 500 watts average power.		Optional Equipment: <u>ASI MN</u> <u>OEM PN</u> <u>Description</u> ASI-328 522-4380-001 Antenna Coupler Test Set (980H-1) ASI-328-1 522-4252-001 Antenna Coupler Control Tester (878L-15) ASI-328-2 522-4253-001 Electronic Control Amplifier Tester (878L-16) ASI-328-3 522-4254-001 Discriminator Tester (878L-17) ASI-328-4 761-4599-001 Power Panel	
Electrical Dummy Load		ASI-329-1A	
OEM Equivalent: Rockwell Collins MN: 172H-8 PN: 522-4514-002 Manual: 523-0758777 Figure: 1-1	UUT: 490T-1/-1A/-2/-2A/-2B/-9 / CU-1658/A Size: H: 7.25" W: 9.25" D: 13.75" Pwr: 115 VAC 60 Hz	Equipment Supplied: <u>ASI MN</u> <u>OEM PN</u> <u>Description</u>	
Description: The ASI-329-1A Electrical Dummy Load is used in conjunction with other test equipment for testing, adjusting, or troubleshooting the 490T-() Antenna Coupler. The ASI-329-1A simulates an aircraft 85 foot long-wire hf antenna or a 437R-1 Helical Monopole Loading Coil and can be used with antenna coupler systems rated up to 500 watts average power.		Optional Equipment: <u>ASI MN</u> <u>OEM PN</u> <u>Description</u> ASI-328 522-4380-001 Antenna Coupler Test Set (980H-1) ASI-328-1 522-4252-001 Antenna Coupler Control Tester (878L-15) ASI-328-2 522-4253-001 Electronic Control Amplifier Tester (878L-16) ASI-328-3 522-4254-001 Discriminator Tester (878L-17) ASI-328-4 761-4599-001 Power Panel	
Electrical Dummy Load		ASI-329-1B	
OEM Equivalent: Rockwell Collins MN: DA-487/U PN: 522-4514-001 Man: TM11-5985-327-15 Fig: 1-1	UUT: 490T-1/-1A/-2/-2A/-2B/-9 / CU-1658/A Size: H: 7.25" W: 9.25" D: 13.75" Pwr: 115 VAC 400 Hz	Equipment Supplied: <u>ASI MN</u> <u>OEM PN</u> <u>Description</u>	
Description: The ASI-329-1B Electrical Dummy Load is used in conjunction with other test equipment for testing, adjusting, or troubleshooting the CU-1658/A Antenna Coupler. The ASI-329-1B simulates an aircraft 85 foot long-wire hf antenna or a 437R-1 Helical Monopole Loading Coil and can be used with antenna coupler systems rated up to 500 watts average power. The ASI-329-1B is identical to the ASI-329-1.		Optional Equipment: <u>ASI MN</u> <u>OEM PN</u> <u>Description</u> ASI-328 522-4380-001 Antenna Coupler Test Set (980H-1) ASI-328-1 522-4252-001 Antenna Coupler Control Tester (878L-15) ASI-328-2 522-4253-001 Electronic Control Amplifier Tester (878L-16) ASI-328-3 522-4254-001 Discriminator Tester (878L-17) ASI-328-4 761-4599-001 Power Panel	
Electrical Dummy Load		ASI-329-1C	
OEM Equivalent: Rockwell Collins MN: 172H-8A PN: 642-2190-001 Manual:	UUT: CU-2041/AR Size: H: 7.25" W: 9.25" D: 13.75" Pwr: 115 VAC 60 Hz	Equipment Supplied: <u>ASI MN</u> <u>OEM PN</u> <u>Description</u>	
Description: The ASI-329-1C Electrical Dummy Load is used in conjunction with other test equipment for testing, adjusting, or troubleshooting the CU-2041/AR Ant Coupler. The ASI-329-1C simulates an aircraft 85 foot long-wire hf antenna or a 437R-1 Helical Monopole Loading Coil and can be used with antenna coupler systems rated up to 500 watts average power.		Optional Equipment: <u>ASI MN</u> <u>OEM PN</u> <u>Description</u> ASI-328 522-4380-001 Antenna Coupler Test Set (980H-1) ASI-328-1 522-4252-001 Antenna Coupler Control Tester (878L-15) ASI-328-2 522-4253-001 Electronic Control Amplifier Tester (878L-16) ASI-328-3 522-4254-001 Discriminator Tester (878L-17) ASI-328-4 761-4599-001 Power Panel	
Dummy Composite Antenna		ASI-329-2	
OEM Equivalent: Rockwell Collins MN: 172H-1 PN: 522-1708-000 Manual: 523-0001000 Figure: 1	UUT: 180R-4/-6/-7/-8/-10 Size: H: 10.50" W: 9.00" D: 15.00" Pwr: 115 VAC 60 Hz	Equipment Supplied: <u>ASI MN</u> <u>OEM PN</u> <u>Description</u>	
Description: The ASI-329-2 Dummy Composite Antenna is used in conjunction with other test equipment for testing, adjusting, or troubleshooting the 180R-() Antenna Coupler. The ASI-329-2 simulates the high Q points of various tail-cap antennas. The ASI-329-2 (172H-1) is interchangeable with the ASI-329-13 (172H-26).		Optional Equipment: <u>ASI MN</u> <u>OEM PN</u> <u>Description</u> ASI-346 522-4748-001 Antenna Coupler Test Set (980H-3) ASI-346-1 522-3022-000 Amplifier Test Set (878L-1) ASI-346-2 522-3271-000 Relay Control Test Set (878L-2) ASI-246-3 522-3272-000 Discriminator Tester (878L-3) ASI-346-4 772-6871-001 Power Panel	
Shunt Dummy Antenna		ASI-329-3	
OEM Equivalent: Rockwell Collins MN: 172H-18A PN: 622-7148-001 Manual: 523-0776293 Figure: 1-1	UUT: 490S-1 / 490S-4 / CU-2314(V)1/-2/-3/-4 CPL-920D / HF-9040 / HF-9041 / HF-9042 Size: H: 7.25" W: 9.25" D: 13.75" Pwr: 115 VAC 60 Hz	Equipment Supplied: <u>ASI MN</u> <u>OEM PN</u> <u>Description</u>	
Description: The ASI-329-3 Shunt Dummy Antenna is used in conjunction with other test equipment for testing, adjusting, or troubleshooting the CPL-920D, 490S-4, CU-2314(V) ()/ARC-190, HF-9040, HF-9041, and HF-9042 Antenna Couplers. The ASI-329-3 simulates an hf shunt type aircraft antenna for use with radio systems rated up to 200 watts average and 630 watts peak envelope power (pep).		Optional Equipment: <u>ASI MN</u> <u>OEM PN</u> <u>Description</u> ASI-207-1 622-0180-001 Shunt Dummy Antenna (172H-18) ASI-207-3 RF High Voltage Fixture for CPL-920D ASI-207-13 652-2443-001 Coaxial Adapter ASI-329-31 Test RF Feedline for CU-2314(V)1/ARC-190 ASI-329-32 Test RF Feedline for CU-2314(V)2/ARC-190 ASI-329-33 Test RF Feedline for CU-2314(V)3/ARC-190 ASI-329-34 Test RF Feedline for CU-2314(V)4/ARC-190 R1	

Electrical Dummy Load		ASI-329-4		
OEM Equivalent: Rockwell Collins MN: DA-174/GRM-10 PN: 522-1248-004 Manual: TO33D7-71-54-1 Fig: 2-2	UUT: 490A-1 / CU-2275(V)1 / CU-2575	Equipment Supplied:		
	Size: H: 11.00" W: 9.375" D: 16.00" Pwr: 115 VAC 60 Hz	<u>ASI MN</u>	<u>OEM PN</u>	<u>Description</u>
Description: The ASI-329-4 Electrical Dummy Load is used in conjunction with other test equipment for testing, adjusting, or troubleshooting the CU-2275(V)1/ARC-190(V), CU-2575/ARC-229, and 490A-1 Antenna Couplers. The ASI-329-4 simulates the characteristics of an aircraft 9 foot probe and tail cap antenna.		Optional Equipment:		
		<u>ASI MN</u>	<u>OEM PN</u>	<u>Description</u>
		ASI-32-94A	NPN	Coaxial Adapter for CU-2275(V)/ARC-190(V)
		ASI-32-94B	NPN	Adapter Bracket for CU-2575/ARC-229
		ASI-32-94C	NPN	Adapter Cable for CU-2575/ARC-229
		ASI-32-94D	NPN	Coupler Adapter Cable for CU-2575/ARC-229
		ASI-329-6	522-1247-002	Resistive Load (DA-173/GRM-10)
Electrical Dummy Load		ASI-329-5		
OEM Equivalent: Rockwell Collins MN: DA-175/GRM-10 PN: 522-1249-004 Manual: TO33D7-71-54-1 Fig: 2-3	UUT: 490A-2 / CU-2275(V)2	Equipment Supplied:		
	Size: H: 7.25" W: 9.25" D: 13.75" Pwr: 115 VAC 60 Hz	<u>ASI MN</u>	<u>OEM PN</u>	<u>Description</u>
Description: The ASI-329-5 Electrical Dummy Load is used in conjunction with other test equipment for testing, adjusting, or troubleshooting the CU-2275(V)2/ARC-190(V) and 490A-2 Antenna Couplers. The ASI-329-5 simulates the characteristics of an aircraft 85 foot long-wire antenna.		Optional Equipment:		
		<u>ASI MN</u>	<u>OEM PN</u>	<u>Description</u>
		ASI-32-94A	NPN	Coaxial Adapter for CU-2275(V)/ARC-190(V)
Electrical Dummy Load		ASI-329-6		
OEM Equivalent: Rockwell Collins MN: DA-173/GRM-10 (694) PN: 522-1247-002 Manual: TO33D7-71-54-1 Fig: 2-1	UUT: 490A-1 / CU-2275(V)1 / CU-2575	Equipment Supplied:		
	Size: H: 8.75" W: 5.12" D: 20.50" Pwr: No External Power Required	<u>ASI MN</u>	<u>OEM PN</u>	<u>Description</u>
Description: The ASI-329-6 Electrical Dummy Load is used in conjunction with other test equipment for testing, adjusting, or troubleshooting the CU-2275(V)1/ARC-190(V), CU-2575/ARC-229, and 490A-1 Antenna Couplers. The ASI-329-5 is a resistive load used with the ASI-329-5 (DA-174/GRM-10) as a 50-Ohm termination.		Optional Equipment:		
		<u>ASI MN</u>	<u>OEM PN</u>	<u>Description</u>
		ASI-329-5	522-1248-004	Electrical Dummy Load (DA-174/GRM-10)
Antenna Simulator		ASI-329-7		
OEM Equivalent: Rockwell Collins MN: 172H-21 PN: 622-1380-001 Manual:	UUT: 490T-3 / 548S-3/-3A/-5/-5A/-6	Equipment Supplied:		
	Size: H: 7.25" W: 9.25" D: 13.75" Pwr: 115 VAC 60 Hz	<u>ASI MN</u>	<u>OEM PN</u>	<u>Description</u>
Description: The ASI-329-7 Antenna Simulator is used in conjunction with other test equipment for testing, adjusting, or troubleshooting the 490T-3 / 548S-3/-3A/-5/-5A/-6 Antenna Couplers. The ASI-329-7 simulates a 16 ft whip antenna (tied down).		Optional Equipment:		
		<u>ASI MN</u>	<u>OEM PN</u>	<u>Description</u>
		ASI-328-3	522-4254-001	Discriminator Tester (878L-17)
		ASI-497-1	622-5285-001	Harmonic Filter (967M-1)
		ASI-497-2	622-5286-001	Amplifier Test Set (967M-2)
		ASI-497-3	622-5287-001	Power Amplifier Test Set (967M-3)
		ASI-497-4	622-5288-001	Control Circuit Test Set (967M-4)
		ASI-497-5	622-5289-001	Preregulator Test Set (967M-5)
Antenna Simulator		ASI-329-8		
OEM Equivalent: Rockwell Collins MN: 172H-21A PN: 622-1732-001 Manual:	UUT: HF-9042	Equipment Supplied:		
	Size: H: 7.25" W: 9.25" D: 13.75" Pwr: 115 VAC 60 Hz	<u>ASI MN</u>	<u>OEM PN</u>	<u>Description</u>
Description: The ASI-329-8 Antenna Simulator is used in conjunction with other test equipment for testing, adjusting and troubleshooting the HF-9042 Antenna Coupler. The ASI-329-8 simulates a 16 ft whip antenna (straight up). The ASI-329-8 is identical to the ASI-329-8-220 with the exception of the power input requirement.		Optional Equipment:		
		<u>ASI MN</u>	<u>OEM PN</u>	<u>Description</u>
		ASI-32-98A	NPN	Cable, ASI-329-8 to HF Antenna Coupler
		ASI-32-98B	NPN	RF Cable, ASI-329-8 to HF Antenna Coupler
		ASI-777	822-1429-001	HF-9000 System Test Panel (TE-9210)
Antenna Simulator		ASI-329-8-220		
OEM Equivalent: Rockwell Collins MN: 172H-21A PN: 622-1732-001 Manual:	UUT: HF-9042	Equipment Supplied:		
	Size: H: 7.25" W: 9.25" D: 13.75" Pwr: 220 VAC 50 Hz	<u>ASI MN</u>	<u>OEM PN</u>	<u>Description</u>
Description: The ASI-329-8-220 Antenna Simulator is used in conjunction with other test equipment for testing, adjusting and troubleshooting the HF-9042 Antenna Coupler. The ASI-329-8-220 simulates a 16 ft whip antenna (straight up). The ASI-329-8-220 is identical to the ASI-329-8 with the exception of the power input requirement.		Optional Equipment:		
		<u>ASI MN</u>	<u>OEM PN</u>	<u>Description</u>
		ASI-32-98A	NPN	Cable, ASI-329-8 to HF Antenna Coupler
		ASI-32-98B	NPN	RF Cable, ASI-329-8 to HF Antenna Coupler
		ASI-777	822-1429-001	HF-9000 System Test Panel (TE-9210)

Electrical Dummy Load		ASI-329-9
OEM Equivalent: Rockwell Collins MN: 172H-17 PN: 777-1864-001 Manual: 523-0761078 Figure: 1-1	UUT: AT-107 / 180R-12 / 180R-17	Equipment Supplied:
	Size: H: 7.25" W: 9.50" D: 14.50" Pwr: 115 VAC 60 Hz	<u>ASI MN</u> <u>OEM PN</u> <u>Description</u>
Description: The ASI-329-9 Electrical Dummy Load is used in conjunction with other test equipment for testing, adjusting, or troubleshooting the 180R-17 Antenna Coupler. The ASI-329-9 simulates an aircraft wing-probe antenna and can be used with antenna coupler systems rated up to 1000 watts peak envelope and 500 watts average power.		Optional Equipment: <u>ASI MN</u> <u>OEM PN</u> <u>Description</u>
Electrical Dummy Load		ASI-329-10
OEM Equivalent: Rockwell Collins MN: 172H-10 PN: 522-4601-001 Manual: 523-0762295 Figure: 1-1	UUT: AT-102A / 180R-6/-6A	Equipment Supplied:
	Size: H: 7.25" W: 9.50" D: 14.50" Pwr: 115 VAC 60 Hz	<u>ASI MN</u> <u>OEM PN</u> <u>Description</u>
Description: The ASI-329-10 Electrical Dummy Load is used in conjunction with other test equipment for testing, adjusting, or troubleshooting the 180R-6/-6A Ant Coupler. The ASI-329-10 simulates an aircraft tail cap-probe antenna and can be used with antenna coupler systems rated up to 1000 watts peak envelope and 500 watts average power.		Optional Equipment: <u>ASI MN</u> <u>OEM PN</u> <u>Description</u>
Shunt Dummy Antenna		ASI-329-11
OEM Equivalent: Rockwell Collins MN: 172H-22 PN: 622-1381-001 Manual: Figure:	UUT: 548S-3/-3A/-5/-5A/-6	Equipment Supplied:
	Size: H: 7.25" W: 9.25" D: 13.75" Pwr: 115 VAC 60 Hz	<u>ASI MN</u> <u>OEM PN</u> <u>Description</u>
Description: The ASI-329-11 Shunt Dummy Antenna is used in conjunction with other test equipment for testing, adjusting, or troubleshooting the 548S-3/-3A/-5/-5A/-6 Antenna Couplers. The ASI-329-11 simulates a 32 ft whip antenna.		Optional Equipment: <u>ASI MN</u> <u>OEM PN</u> <u>Description</u> ASI-328-3 522-4254-001 Discriminator Tester (878L-17) ASI-497-1 622-5285-001 Harmonic Filter (967M-1) ASI-497-2 622-5286-001 Amplifier Test Set (967M-2) ASI-497-3 622-5287-001 Power Amplifier Test Set (967M-3) ASI-497-4 622-5288-001 Control Circuit Test Set (967M-4) ASI-497-5 622-5289-001 Preregulator Test Set (967M-5)
Dummy Antenna		ASI-329-12
OEM Equivalent: Rockwell Collins MN: 172H-12 PN: 777-1455-001 Manual: 523-0761537 Figure: 1-1	UUT: 490R-6	Equipment Supplied:
	Size: H: 9.12" W: 12.00" D: 18.50" Pwr: 115 VAC 60 Hz	<u>ASI MN</u> <u>OEM PN</u> <u>Description</u>
Description: The ASI-329-12 Dummy Antenna is used in conjunction with other test equipment for testing, adjusting, or troubleshooting the 490-6 Antenna Couplers. The ASI-329-12 simulates an aircraft hf shunt antenna and can be used with antenna coupler systems rated up to 500 watts average power and 630 watts peak envelope power.		Optional Equipment: <u>ASI MN</u> <u>OEM PN</u> <u>Description</u>
Electrical Dummy Load		ASI-329-13
OEM Equivalent: Rockwell Collins MN: 172H-26 PN: 622-5605-001 Manual: Figure:	UUT: 180R-4/-6/-7/-8/-10	Equipment Supplied:
	Size: H: 9.25" W: 12.00" D: 18.50" Pwr: No External Power Required	<u>ASI MN</u> <u>OEM PN</u> <u>Description</u>
Description: The ASI-329-13 Dummy Composite Antenna is used in conjunction with other test equipment for testing, adjusting, or troubleshooting the 180R-() Antenna Couplers. The ASI-329-13 simulates the high Q points of various tail-cap antennas. The ASI-329-13 (172H-26) is interchangeable with the ASI-329-2 (172H-1).		Optional Equipment: <u>ASI MN</u> <u>OEM PN</u> <u>Description</u> ASI-346 522-4748-001 Antenna Coupler Test Set (980H-3) ASI-346-1 522-3022-000 Amplifier Test Set (878L-1) ASI-346-2 522-3271-000 Relay Control Test Set (878L-2) ASI-246-3 522-3272-000 Discriminator Tester (878L-3) ASI-346-4 772-6871-001 Power Panel
Antenna Simulator		ASI-329-14
OEM Equivalent: Rockwell Collins MN: 172H-27 PN: 4S61700-101B Manual: Figure:	UUT: CU-2275(V)3	Equipment Supplied:
	Size: H: 9.25" W: 12.00" D: 18.50" Pwr: 115 VAC 60Hz	<u>ASI MN</u> <u>OEM PN</u> <u>Description</u>
Description: The ASI-329-14 Antenna Simulator is used in conjunction with other test equipment for testing, adjusting, or troubleshooting the CU-2275(V)3/ARC-190(V) Antenna Coupler.		Optional Equipment: <u>ASI MN</u> <u>OEM PN</u> <u>Description</u> ASI-329-141 652-2440-001 Test RF Feedline for CU-2275(V)3/ARC-190(V)

Radar Altimeter Test Set

ASI-332

Description of Operation:

The ASI-332 Test Set was constructed to test the Honeywell YG7500/YG7600 family of Radar Altimeter Systems.

Equivalent OEM: Honeywell

Equivalent MN: UG2559AB02-10

Equivalent PN:

Units Tested:

HG7501AB01, 2

HG7501AD02, 4

HG7501AE01

HG7501AF02

HG7502AC01, 2, 3, 4

HG7505AB01, 2

HG7601AC01

HG7602AC01, 2, 3, 4, 5

HG7605AC01, 2

The Test Set performs the following functions:

1. Tester Power switch for Test Set and internal power supplies.
2. Test points on Test Set allow for signal inputs and outputs of altimeter components to be monitored.
3. Selects test mode and interconnects power and signal lines as needed.
4. Panel Meter for measuring of various power supply and signal voltages on the YG7500/YG7600 Radar Systems.
5. Self Test Switch to activate Altimeter Self Test Circuit.
6. Range Thumbwheel Switches for Range accuracy tests of Receiver-Transmitter Unit.
7. +28 VDC and +5 VDC power sources are provided for indicator dial lighting.
8. Remote Indicator Cable for connecting to Remote Indicator.
9. Tracker Test Cable for connecting the Test Set to test points in range computer.
10. Test Set accepts +26-30 VDC power supply input.

Equipment Supplied:

ASI-33-2A	10048643-101	Cable, Tracker
ASI-33-2B	10066683-101	Cable, Remote Indicator
ASI-33-2C	10066682-101	Cable Assy, RT

Equipment Specifications:

Height: 3.00" Width: 12.00" Depth: 8.00"

Optional Equipment

ASI-332 UG2926AA Calibration Unit

Calibration Unit

ASI-333

Description of Operation:

The ASI-333 Calibration Unit Set provides for online, in aircraft testing of various 7502 Radar Altimeter Systems.

Equivalent OEM: Honeywell

Equivalent MN: UG2926AA01

Equivalent PN:

Units Tested:

HG7502BC02

HG7502BC03

HG7502BC04

The Test Set performs the following functions:

1. Supplies 115 VAC power requirement on interconnect assembly, 1A1.
2. Altitude Slew function for calibration of ground proximity warning system or flight control systems.
3. Manual program altitude signal of Receiver-Transmitter assembly.
4. Supply test points to enable monitoring of various signals.
5. Must be used with ASI-332 (UG2559AB) Radar Altimeter Test Set.

Equipment Supplied:

ASI-33-3A	1066670-101	Cable, W1
ASI-33-3B	1066671-101	Cable, W2
ASI-33-3C	1066672-101	Cable, W3
ASI-33-3D	1066673-101	Cable, W4

Equipment Specifications:

Height: 3.00" Width: 12.00" Depth: 8.00"

Optional Equipment

ASI-332 UG2559AB Radar Alt Test Set

HF System Interconnect Test Set		ASI-338-1																																	
OEM Equivalent: Rockwell Collins MN: CTS-200 PN: 622-4281-001 Manual: 523-0769551 Manual Figure: 1-1	UUT: HF-200/-220/-230 HF System AAC-2X0/TCR-2X0/PWR-2X0/CTL-2X0 Size: H: 4.25" W: 13.25" D: 7.75" Pwr: 28 VDC	Equipment Supplied: <table border="1"> <thead> <tr> <th>ASI MN</th> <th>OEM PN</th> <th>Description</th> </tr> </thead> <tbody> <tr> <td>ASI-33-81A</td> <td>638-2405-001</td> <td>ALC Monitor</td> </tr> <tr> <td>ASI-33-81B</td> <td>638-2406-001</td> <td>Sniffer</td> </tr> <tr> <td>ASI-33-81C</td> <td>638-2362-001</td> <td>RF/TCR RF Cable</td> </tr> <tr> <td>ASI-33-81D</td> <td>638-2388-001</td> <td>RF/PWR RF Cable</td> </tr> </tbody> </table>	ASI MN	OEM PN	Description	ASI-33-81A	638-2405-001	ALC Monitor	ASI-33-81B	638-2406-001	Sniffer	ASI-33-81C	638-2362-001	RF/TCR RF Cable	ASI-33-81D	638-2388-001	RF/PWR RF Cable																		
ASI MN	OEM PN	Description																																	
ASI-33-81A	638-2405-001	ALC Monitor																																	
ASI-33-81B	638-2406-001	Sniffer																																	
ASI-33-81C	638-2362-001	RF/TCR RF Cable																																	
ASI-33-81D	638-2388-001	RF/PWR RF Cable																																	
Description: The ASI-338-1 Test Set provides a means to troubleshoot the HF-200/-220/-230 system down to the box level or for providing a hot mockup for pre-installation testing. The ASI-338-1 includes an attached pendant cable for the CTL-200 HF Control. Use of the CTL-201/201A/220 or CTL-230 requires optional adapter cables.		Optional Equipment: <table border="1"> <thead> <tr> <th>ASI MN</th> <th>OEM PN</th> <th>Description</th> </tr> </thead> <tbody> <tr> <td>ASI-33-81E</td> <td>634-9480-001</td> <td>ASI-338-1 to CTL-201/201A/220 Adapter Cable</td> </tr> <tr> <td>ASI-33-81F</td> <td>TP6-3955-013-1</td> <td>ASI-338-1 to CTL-230 Adapter Cable</td> </tr> <tr> <td>ASI-33-83H</td> <td>628-8518-001</td> <td>ASI-338-1/-3 to PAC-200/230 Adapter Cable</td> </tr> <tr> <td>ASI-33-83J</td> <td>628-8519-001</td> <td>PAC-200/230 Antenna Simulator (Dummy Load)</td> </tr> </tbody> </table>	ASI MN	OEM PN	Description	ASI-33-81E	634-9480-001	ASI-338-1 to CTL-201/201A/220 Adapter Cable	ASI-33-81F	TP6-3955-013-1	ASI-338-1 to CTL-230 Adapter Cable	ASI-33-83H	628-8518-001	ASI-338-1/-3 to PAC-200/230 Adapter Cable	ASI-33-83J	628-8519-001	PAC-200/230 Antenna Simulator (Dummy Load)																		
ASI MN	OEM PN	Description																																	
ASI-33-81E	634-9480-001	ASI-338-1 to CTL-201/201A/220 Adapter Cable																																	
ASI-33-81F	TP6-3955-013-1	ASI-338-1 to CTL-230 Adapter Cable																																	
ASI-33-83H	628-8518-001	ASI-338-1/-3 to PAC-200/230 Adapter Cable																																	
ASI-33-83J	628-8519-001	PAC-200/230 Antenna Simulator (Dummy Load)																																	
HF Antenna Simulator		ASI-338-2																																	
OEM Equivalent: Rockwell Collins MN: CTS-201 PN: 622-4282-001 Manual: 523-0769551 Manual Figure: 1-1	UUT: HF-200/-220/-230 HF System AAC-200/200P/220/220P Size: H: 7.12" W: 9.37" D: 13.25" Pwr: N/A	Equipment Supplied: <table border="1"> <thead> <tr> <th>ASI MN</th> <th>OEM PN</th> <th>Description</th> </tr> </thead> <tbody> <tr> <td></td> <td></td> <td></td> </tr> </tbody> </table>	ASI MN	OEM PN	Description																														
ASI MN	OEM PN	Description																																	
Description: The ASI-338-2 simulates a 16 Foot (4.88 m) grounded wire or a shunt fed antenna.		Optional Equipment: <table border="1"> <thead> <tr> <th>ASI MN</th> <th>OEM PN</th> <th>Description</th> </tr> </thead> <tbody> <tr> <td></td> <td></td> <td></td> </tr> </tbody> </table>	ASI MN	OEM PN	Description																														
ASI MN	OEM PN	Description																																	
HF Transceiver-PA Test Panel		ASI-338-3																																	
OEM Equivalent: Rockwell Collins MN: CTS-202 PN: 622-4283-001 Manual: 523-0769551 Manual Figure: 1-1	UUT: AAC-200/200P/220/220P, PAC-200/230 PWR-200/230, TCR-200/220/230 Size: H: 7.00" W: 19.00" D: 6.00" Pwr: 28 VDC	Equipment Supplied: <table border="1"> <thead> <tr> <th>ASI MN</th> <th>OEM PN</th> <th>Description</th> </tr> </thead> <tbody> <tr> <td>ASI-33-83A</td> <td>838-2383-001</td> <td>ASI-338-3 to TCR Cable (W3)</td> </tr> <tr> <td>ASI-33-83B</td> <td>838-2384-001</td> <td>ASI-338-3 to PWR Cable (W4)</td> </tr> <tr> <td>ASI-33-83C</td> <td>638-2385-001</td> <td>ASI-338-3 to AAC Cable (W5)</td> </tr> <tr> <td>ASI-33-83D</td> <td>638-2404-001</td> <td>ALC Capacitor</td> </tr> <tr> <td>ASI-33-83E</td> <td>634-9021-001</td> <td>Test Fixture</td> </tr> <tr> <td>ASI-33-83F</td> <td>634-9022-001</td> <td>Discriminator Alignment Box</td> </tr> <tr> <td>ASI-33-81A</td> <td>638-2405-001</td> <td>ALC Monitor</td> </tr> <tr> <td>ASI-33-81B</td> <td>638-2406-001</td> <td>Sniffer</td> </tr> <tr> <td>ASI-33-81C</td> <td>638-2362-001</td> <td>RF/TCR RF Cable (W2)</td> </tr> <tr> <td>ASI-33-81D</td> <td>638-2388-001</td> <td>RF/PWR RF Cable (W1)</td> </tr> </tbody> </table>	ASI MN	OEM PN	Description	ASI-33-83A	838-2383-001	ASI-338-3 to TCR Cable (W3)	ASI-33-83B	838-2384-001	ASI-338-3 to PWR Cable (W4)	ASI-33-83C	638-2385-001	ASI-338-3 to AAC Cable (W5)	ASI-33-83D	638-2404-001	ALC Capacitor	ASI-33-83E	634-9021-001	Test Fixture	ASI-33-83F	634-9022-001	Discriminator Alignment Box	ASI-33-81A	638-2405-001	ALC Monitor	ASI-33-81B	638-2406-001	Sniffer	ASI-33-81C	638-2362-001	RF/TCR RF Cable (W2)	ASI-33-81D	638-2388-001	RF/PWR RF Cable (W1)
ASI MN	OEM PN	Description																																	
ASI-33-83A	838-2383-001	ASI-338-3 to TCR Cable (W3)																																	
ASI-33-83B	838-2384-001	ASI-338-3 to PWR Cable (W4)																																	
ASI-33-83C	638-2385-001	ASI-338-3 to AAC Cable (W5)																																	
ASI-33-83D	638-2404-001	ALC Capacitor																																	
ASI-33-83E	634-9021-001	Test Fixture																																	
ASI-33-83F	634-9022-001	Discriminator Alignment Box																																	
ASI-33-81A	638-2405-001	ALC Monitor																																	
ASI-33-81B	638-2406-001	Sniffer																																	
ASI-33-81C	638-2362-001	RF/TCR RF Cable (W2)																																	
ASI-33-81D	638-2388-001	RF/PWR RF Cable (W1)																																	
Description: The ASI-338-3 Transceiver PA Test Panel will test the various components of the HF-200/220/230 HF System. The Test Panel provides interconnection, discretes, internal power, lamp operation, and simulated PWR-200/230 ALC feedback voltage. The ASI-338-3 provides a more comprehensive test of the entire HF-System than the ASI-338-1 (CTS-200) is capable of providing. The 338-3 will test the TCR-200 individually. Testing the TCR-220/230 requires a CTS-204 (ASI-338-5) and a known good CTL-220/230. Testing the PWR-200/230 requires a known good TCR-200/220/230 and an AAC-200/200P/220/220P or PAC-200/230. Accessory cables and test fixtures that may also be required for testing the HF-200/220/230 System are listed in the Optional Equipment section to the right.		Optional Equipment: <table border="1"> <thead> <tr> <th>ASI MN</th> <th>OEM PN</th> <th>Description</th> </tr> </thead> <tbody> <tr> <td>ASI-Y-1</td> <td>634-9848-001</td> <td>ASI-338-3 to CTL-220/230 / TCR-220/230 Y Adapt</td> </tr> <tr> <td>ASI-Y-2</td> <td>653-2159-001</td> <td>CTL-230 Adapter Cable (ASI-Y-1 to CTL-230)</td> </tr> <tr> <td>ASI-33-83G</td> <td>628-8442-001</td> <td>AAC Cable (AAC with Circular Connector Only)</td> </tr> <tr> <td>ASI-33-83H</td> <td>628-8518-001</td> <td>ASI-338-1/-3 to PAC-200/230 Adapter Cable</td> </tr> <tr> <td>ASI-33-83J</td> <td>628-8519-001</td> <td>PAC-200/230 Antenna Simulator (Dummy Load)</td> </tr> <tr> <td>ASI-33-83K</td> <td>622-8522-001</td> <td>PAC-200/230 Test Cradle</td> </tr> <tr> <td>ASI-33-83L</td> <td>TP6-1146-011</td> <td>ATM-200 Breakout Cable</td> </tr> <tr> <td>ASI-338-7</td> <td>628-8554-001</td> <td>DSA-220 Test Set</td> </tr> <tr> <td>ASI-338-8</td> <td>628-8557-001</td> <td>LWA-200 Test Set</td> </tr> </tbody> </table>	ASI MN	OEM PN	Description	ASI-Y-1	634-9848-001	ASI-338-3 to CTL-220/230 / TCR-220/230 Y Adapt	ASI-Y-2	653-2159-001	CTL-230 Adapter Cable (ASI-Y-1 to CTL-230)	ASI-33-83G	628-8442-001	AAC Cable (AAC with Circular Connector Only)	ASI-33-83H	628-8518-001	ASI-338-1/-3 to PAC-200/230 Adapter Cable	ASI-33-83J	628-8519-001	PAC-200/230 Antenna Simulator (Dummy Load)	ASI-33-83K	622-8522-001	PAC-200/230 Test Cradle	ASI-33-83L	TP6-1146-011	ATM-200 Breakout Cable	ASI-338-7	628-8554-001	DSA-220 Test Set	ASI-338-8	628-8557-001	LWA-200 Test Set			
ASI MN	OEM PN	Description																																	
ASI-Y-1	634-9848-001	ASI-338-3 to CTL-220/230 / TCR-220/230 Y Adapt																																	
ASI-Y-2	653-2159-001	CTL-230 Adapter Cable (ASI-Y-1 to CTL-230)																																	
ASI-33-83G	628-8442-001	AAC Cable (AAC with Circular Connector Only)																																	
ASI-33-83H	628-8518-001	ASI-338-1/-3 to PAC-200/230 Adapter Cable																																	
ASI-33-83J	628-8519-001	PAC-200/230 Antenna Simulator (Dummy Load)																																	
ASI-33-83K	622-8522-001	PAC-200/230 Test Cradle																																	
ASI-33-83L	TP6-1146-011	ATM-200 Breakout Cable																																	
ASI-338-7	628-8554-001	DSA-220 Test Set																																	
ASI-338-8	628-8557-001	LWA-200 Test Set																																	
HF Coupler Logic Test Panel		ASI-338-4																																	
OEM Equivalent: Rockwell Collins MN: CTS-203 PN: 622-4285-001 Manual: 523-0769551 Manual Figure: 1-1	UUT: AAC-200/-200P/-220/-220P PAC-200/-230 Size: H: 7.00" W: 19.00" D: 6.00" Pwr: 28 VDC	Equipment Supplied: <table border="1"> <thead> <tr> <th>ASI MN</th> <th>OEM PN</th> <th>Description</th> </tr> </thead> <tbody> <tr> <td>ASI-33-84A</td> <td>638-2448-001</td> <td>CTS-203 to Coupler Logic Card</td> </tr> </tbody> </table>	ASI MN	OEM PN	Description	ASI-33-84A	638-2448-001	CTS-203 to Coupler Logic Card																											
ASI MN	OEM PN	Description																																	
ASI-33-84A	638-2448-001	CTS-203 to Coupler Logic Card																																	
Description: The ASI-338-4 HF Coupler Logic Test Panel provides signals, discretes, power, and output monitoring required to test the AAC/PAC antenna coupler circuit cards.		Optional Equipment: <table border="1"> <thead> <tr> <th>ASI MN</th> <th>OEM PN</th> <th>Description</th> </tr> </thead> <tbody> <tr> <td>ASI-33-84B</td> <td>628-8526-001(1)</td> <td>PAC 200/230 In Circuit Test Cable</td> </tr> <tr> <td>ASI-33-84C</td> <td>628-8526-001(2)</td> <td>PAC-200/230 Out of Circuit Test Cable</td> </tr> </tbody> </table>	ASI MN	OEM PN	Description	ASI-33-84B	628-8526-001(1)	PAC 200/230 In Circuit Test Cable	ASI-33-84C	628-8526-001(2)	PAC-200/230 Out of Circuit Test Cable																								
ASI MN	OEM PN	Description																																	
ASI-33-84B	628-8526-001(1)	PAC 200/230 In Circuit Test Cable																																	
ASI-33-84C	628-8526-001(2)	PAC-200/230 Out of Circuit Test Cable																																	
HF Control Test Panel		ASI-338-5																																	
OEM Equivalent: Rockwell Collins MN: CTS-204 PN: 622-5403-001 Manual: 523-0769551 Manual Figure: 1-1	UUT: CTL-200/-201/-201A/-220 Size: H: 5.25" W: 19.00" D: 6.00" Pwr: 28 VDC	Equipment Supplied: <table border="1"> <thead> <tr> <th>ASI MN</th> <th>OEM PN</th> <th>Description</th> </tr> </thead> <tbody> <tr> <td>ASI-33-85A</td> <td>634-9995-001</td> <td>ASI-338-5 to CTL-201/201A/220 (W1)</td> </tr> <tr> <td>ASI-33-85B</td> <td>634-9996-001</td> <td>ASI-338-5 to CTL-200 (W2)</td> </tr> <tr> <td>ASI-33-85C</td> <td>634-9994-001</td> <td>ASI-338-5 to CTS-202 (W3)</td> </tr> </tbody> </table>	ASI MN	OEM PN	Description	ASI-33-85A	634-9995-001	ASI-338-5 to CTL-201/201A/220 (W1)	ASI-33-85B	634-9996-001	ASI-338-5 to CTL-200 (W2)	ASI-33-85C	634-9994-001	ASI-338-5 to CTS-202 (W3)																					
ASI MN	OEM PN	Description																																	
ASI-33-85A	634-9995-001	ASI-338-5 to CTL-201/201A/220 (W1)																																	
ASI-33-85B	634-9996-001	ASI-338-5 to CTL-200 (W2)																																	
ASI-33-85C	634-9994-001	ASI-338-5 to CTS-202 (W3)																																	
Description: The ASI-338-5 HF Control Test Set provides signals, discretes, power, and output monitoring required to test the HF-200/220 Controls (CTL-200, CTL-201, CTL-201A, and CTL-220).		Optional Equipment: <table border="1"> <thead> <tr> <th>ASI MN</th> <th>OEM PN</th> <th>Description</th> </tr> </thead> <tbody> <tr> <td>ASI-33-85D</td> <td>TP6-2800-013</td> <td>Selcal Wiring Check Adapter for CTL-220</td> </tr> <tr> <td>ASI-200-6</td> <td>NPN</td> <td>ASI-2000 Plug In Test Adapter for CTL-230</td> </tr> </tbody> </table>	ASI MN	OEM PN	Description	ASI-33-85D	TP6-2800-013	Selcal Wiring Check Adapter for CTL-220	ASI-200-6	NPN	ASI-2000 Plug In Test Adapter for CTL-230																								
ASI MN	OEM PN	Description																																	
ASI-33-85D	TP6-2800-013	Selcal Wiring Check Adapter for CTL-220																																	
ASI-200-6	NPN	ASI-2000 Plug In Test Adapter for CTL-230																																	
HF PROM Frequency Programmer		ASI-338-6																																	
OEM Equivalent: Rockwell Collins MN: PFP-200 PN: 622-3839-001 Manual: 523-0769551 Manual Figure: 1-1	UUT: HF-200/-220 HF System TCR-200/220 Size: H: 5.0" W: 9.37" D: 11.75" Pwr: 115 VAC 50-60 Hz	Equipment Supplied: <table border="1"> <thead> <tr> <th>ASI MN</th> <th>OEM PN</th> <th>Description</th> </tr> </thead> <tbody> <tr> <td></td> <td></td> <td></td> </tr> </tbody> </table>	ASI MN	OEM PN	Description																														
ASI MN	OEM PN	Description																																	
Description: The ASI-338-6 programs and reads the TCR-200/220 A1 Frequency Program Cards.		Optional Equipment: <table border="1"> <thead> <tr> <th>ASI MN</th> <th>OEM PN</th> <th>Description</th> </tr> </thead> <tbody> <tr> <td></td> <td></td> <td></td> </tr> </tbody> </table>	ASI MN	OEM PN	Description																														
ASI MN	OEM PN	Description																																	

Antenna Coupler Test Set**ASI-339****Description of Operation:**

The ASI-339 provides testing of the 309A-17 Coupler Control and modules/circuit cards from the 180R-17.

Equivalent OEM: Collins

Equivalent MN: 980H-6

Equivalent PN: 777-1534-001

Units Tested:

AT-107

180R-17

309A-17

The ASI-339 includes the ASI-339-1, ASI-339-2, ASI-339-3, ASI-339-4, and ASI-339-5 in a rugged case.

Equipment Supplied:

ASI-339-1	Discriminator Test Panel (878L-19A)
ASI-339-2	Electronic Control Amp Test Panel (878L-28)
ASI-339-3	Coupler Control Test Panel (878L-29)
ASI-339-4	Coupler Circuit Card Test Panel (878L-30)
ASI-339-5	Power Panel (792-0070-001)

Equipment Specifications:

Height: 24.50" Width: 22.00" Depth: 24.50"

Discriminator Panel**ASI-339-1****Description of Operation:**

The ASI-339-1 permits testing and alignment of the discriminator module contained in the 180R-17 Antenna Coupler. The discriminator error signals are monitored by a meter on the front panel of the ASI-339-1

Equivalent OEM: Collins

Equivalent MN: 878L-19A

Equivalent PN: 772-5291-001

Units Tested:

180R-17

Equipment Supplied:

ASI-33-91A	RF Cable
ASI-33-91B	Housing (772-6874-001)
ASI-33-91C	Housing (772-6875-001)

Equipment Specifications:

Height: 5.25" Width: 19.00" Depth: 7.125"

Electronic Control Amplifier Test Panel**ASI-339-2****Description of Operation:**

The ASI-339-2 permits testing of the 180R-17 Antenna Coupler servo amplifier circuit board assembly and output amplifier module. Two cables and a card holder are supplied with the test panel.

Equivalent OEM: Collins

Equivalent MN: 878L-28

Equivalent PN: 777-1856-001

Units Tested:

180R-17

Equipment Supplied:

ASI-33-92A	3W2 Cable (791-3393-001)
ASI-33-92B	Card Extender (791-3381-001)
ASI-33-9A	3W1 Cable (775-9706-001)

Equipment Specifications:

Height: 3.50" Width: 19.00" Depth: 7.25"

Coupler Control Test Panel**ASI-339-3****Description of Operation:**

The ASI-339-3 permits complete testing of the 309A-17 Coupler Control. The ASI-339-3 also tests the coupler control interface card, coupler control sequence logic, and self test card.

Equivalent OEM: Collins

Equivalent MN: 878L-29

Equivalent PN: 777-1857-001

Units Tested:

309A-17

The test panel includes a cardholder, cable adapter, card extender, and three cables.

Equipment Supplied:

ASI-33-93A	Card Holder (792-0055-001)
ASI-33-93B	Cable Adapter (792-0042-001)
ASI-33-93C	Card Extender (787-8303-001)
ASI-33-93D	2W1 Cable (792-0031-001)
ASI-33-93E	2W2 Cable (792-0032-001)
ASI-33-9A	2W3 Cable (775-9706-001)

Equipment Specifications:

Height: 5.25" Width: 19.00" Depth: 7.25"

Coupler Circuit Card Test Panel**ASI-339-4****Description of Operation:**

The ASI-339-4 tests the digital no 1, digital no 2, band information, and analog circuit card assemblies of the 180R-17. The test panel includes a card holder and two cables.

Equivalent OEM: Collins

Equivalent MN: 878L-30

Equivalent PN: 777-1858-001

Units Tested:

180R-17

Equipment Supplied:

ASI-33-94A	Card Holder (791-3366-001)
ASI-33-94B	1W2 Cable (787-8891-001)
ASI-33-9A	1W1 Cable (775-9706-001)

Equipment Specifications:

Height: 3.50" Width: 19.00" Depth: 7.25"

Power Panel**ASI-339-5****Description of Operation:**

The ASI-339-4 Power Panel controls AC power input into the ASI-339.

Equivalent OEM: Collins

Equivalent MN:

Equivalent PN: 792-0070-001

Units Tested:

Equipment Specifications:

Height: 1.75" Width: 19.00" Depth: 2.00"

Equipment Supplied:

ASI-33-95A	Power Cable (792-0202-001)
------------	----------------------------

REV 2
3-1-98

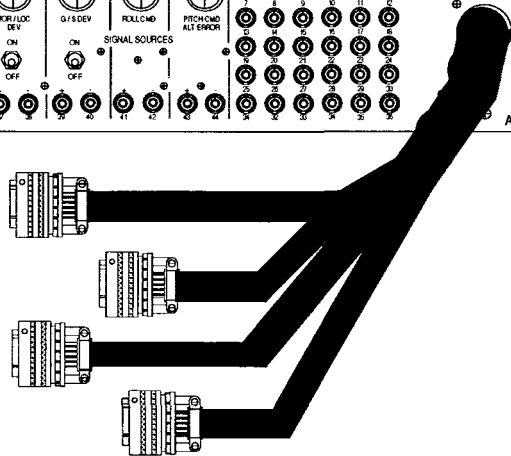
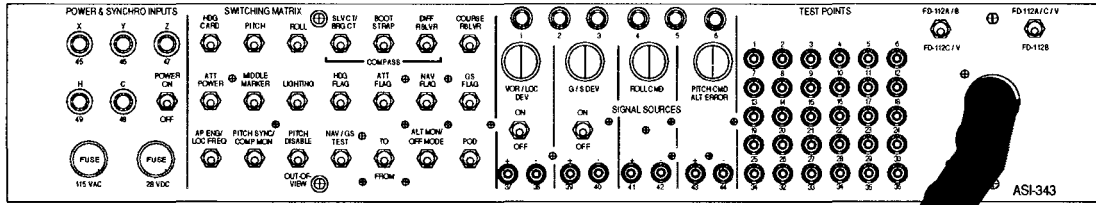

This unit is manufactured to replace the OEM model and/or part number listed below in form, fit, and function.

Equivalent OEM: Rockwell Collins

Equivalent MN:

Equivalent PN:

Manual Figure: FD-112A Fig. 1002 - 1004
 FD-112B Repair Section Fig. 1 - 2
 FD-112C Repair Section Fig. 1 - 2
 FD-112V Repair Section Fig. 1 - 2

Units Tested:

FD-112A

FD-112B

FD-112C

FD-112V

Description of Operation:

The ASI-343 Test Panel facilitates testing of the Collins FD-112() Flight Director Indicator. The test panel provides power, test points, switching, loading and interconnect required to test the FD-112(). Four hardwired cables are included to connect the ASI-343 to the FD-112 under test.

The ASI-343 is configured to work in conjunction with a 978F-2S (ASI-167) synchro source and other standard test equipment to fully test the FD-112().

Specifications:

Height: 3.50" Width: 19.00" Depth: 4.00"

Power: 115 VAC 400 Hz and 28 VDC

Equipment Supplied:

ASI MN	Equivalent PN	Description
--------	---------------	-------------

Optional Equipment:

ASI MN	Equivalent PN	Description
ASI-167	522-3498-000	Synchro Source (978F-2S)

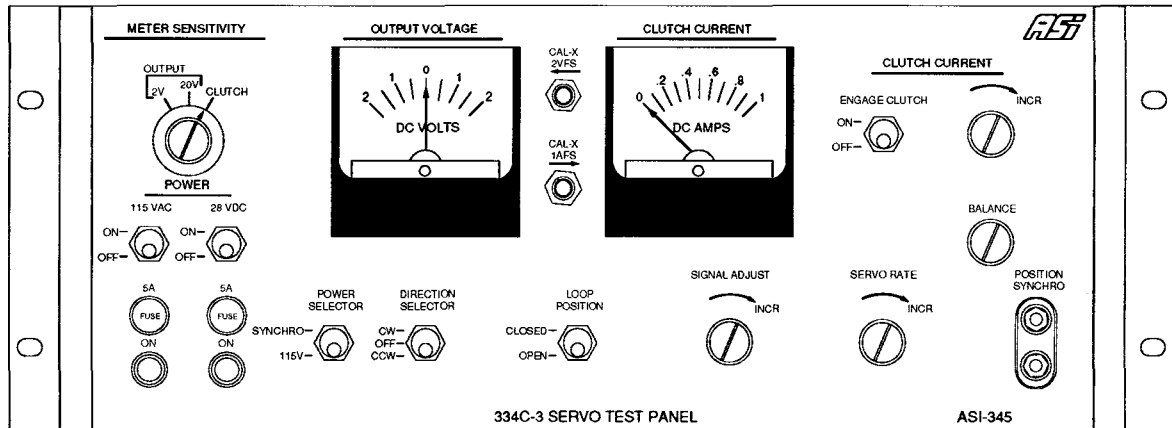

This unit is manufactured to replace the OEM model and/or part number listed below in form, fit, and function.

Equivalent OEM: Collins

Equivalent MN: 578F-1

Equivalent PN: 522-1977-000 / 029-4604-000

Manual Figure: 334C-3() Fig. 1003 - 1004A

Units Tested:

334C-3, 334C-3A, 334C-3B

334C-3C, 334C-3D, 334C-3E

334C-3F

Description of Operation:

The ASI-345 provides all functions required to test Collins 334C-3() Primary Servo.

The ASI-345 supplies a DC signal to the S-1 Servo Amplifier. The tester also supplies DC power to engage the clutch. A panel meter allows for monitoring of S-1 servo amplifier voltage output voltage or engage clutch voltage. The tester also allows signal to rate generator to be controlled.

Specifications:

Height: 7.00" Width: 19.00" Depth: 6.00"

Power: 115 VAC 400 Hz, 28 VDC

Equipment Supplied:

ASI MN	Equivalent PN	Description
--------	---------------	-------------

Optional Equipment:

ASI MN	Manual Figure	Description
--------	---------------	-------------

Antenna Coupler Test Set**ASI-346****Description of Operation:**

The ASI-346 provides a means to completely test the discriminator, electronic control amplifier, and relay control modules of the 180R-() Antenna Couplers and 309A-() Antenna Coupler Controls.

The ASI-346 includes the ASI-346-1 Amplifier Test Set, ASI-346-2 Relay Control Test Set, ASI-346-3 Discriminator Test Set, and ASI-346-4 Power Panel in a rugged case.

Equivalent OEM: Collins
 Equivalent MN: 980H-3
 Equivalent PN: 522-4748-001

Units Tested:
 180R-4/4A/6/6A/7/8/10A
 309A-1/1A/2/2D/2E/2F/3

Equipment Supplied:

ASI-346-1	Amplifier Test Set (878L-1)
ASI-346-2	Relay Control Test Set (878L-2)
ASI-346-3	Discriminator Test Set (878L-3)
ASI-346-4	Power Panel (772-6871-001)

Equipment Specifications:

Height: 30.00" Width: 22.00" Depth: 15.875"

Amplifier Test Set**ASI-346-1****Description of Operation:**

The ASI-346-1 facilitates testing of the antenna coupler control servo amplifiers. The ASI-346-1 simulates actual operating conditions by presenting the proper load conditions and providing all working voltages. External test points allow access to servo amplifier outputs for alignment and troubleshooting.

Equivalent OEM: Collins
 Equivalent MN: 878L-1
 Equivalent PN: 522-3022-000

Units Tested:
 180R-4/4A/6/6A/7/8/10A
 309A-1/1A/2/2D/2E/2F/3

Equipment Supplied:**Equipment Specifications:**

Height: 5.25" Width: 19.00" Depth: 11.25"

Relay Control Test Set**ASI-346-2****Description of Operation:**

The ASI-346-2 completely tests the antenna coupler control relay assembly group modules.

Equivalent OEM: Collins
 Equivalent MN: 878L-2
 Equivalent PN: 522-3271-000

Units Tested:
 309A-1/1A/2/2D/2E/2F/3
 AN/ARC-80

The ASI-346-2 employs lamp comparison and voltage readings for a go/no-go test of the relay assembly group modules.

Equipment Supplied:

ASI-34-62A	Test Cable (554-4825-000)
------------	---------------------------

Equipment Specifications:

Height: 10.50" Width: 19.00" Depth: 9.00"

Discriminator Test Set**ASI-346-3****Description of Operation:**

The ASI-346-3 facilitates testing of the antenna coupler discriminator modules.

Equivalent OEM: Collins
 Equivalent MN: 878L-3
 Equivalent PN: 522-3272-000

Units Tested:
 180R-4/4A/6/6A/7/8/10A
 CU-523, CU-1094, CU-1239

The ASI-346-2 simulates actual operating conditions often experienced by the uut.

Equipment Supplied:

ASI-34-63A	RF Cable (772-6877-001)
UG-564/U	RF Adapter, N Plug / C Jack (357-9560-000)
UG-702/U	RF Adapter, HN Plug / C Jack (357-9296-000)

Equipment Specifications:

Height: 8.75" Width: 19.00" Depth: 9.25"

Power Panel**ASI-346-4****Description of Operation:**

The ASI-346-4 Power Panel controls AC power input into the ASI-346.

Equivalent OEM: Collins
 Equivalent MN:
 Equivalent PN: 772-6871-001

Units Tested:

Power input is supplied through the W1 cable (ASI-34-6C).

Equipment Supplied:

ASI-34-64A	Power Cable (772-6878-001)
------------	----------------------------

Equipment Specifications:

Height: 1.75" Width: 19.00" Depth: 2.00"

REV 2
 3-1-98

Servo Test Panel

ASI-348-1

OEM Equivalent: Rockwell Collins MN: NMN PN: NPN Manual: 523-0771890 Manual Figure: 5-10 - 5-11	UUT: SVO-65 SMT-65/-65A/-65B/-65C/-65D/-65E/-65F
	Size: H: 3.50" W: 19.00" D: 6.00" Pwr: 28 VDC

Description:
The ASI-348-1 Servo Test Panel works in conjunction with a torque tester (ASI-212-5 or Modified ASI-212-3) to facilitate testing of the Collins SVO-65 Primary Servo and SMT-65() Servo Mount.

The ASI-348-1 is equivalent to the Optional Test Set shown in the SVO-65 repair manual and provides power inputs, discrete controls, and meter test points required during testing and troubleshooting of the servo.

The ASI-348-1 includes the SVO-65 test cable (ASI-34-8A).

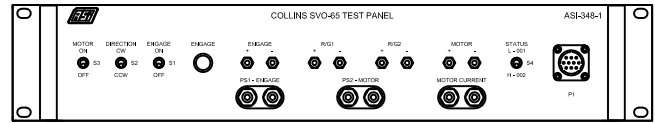

Equipment Supplied:

ASI MN	OEM PN	Description
ASI-34-8A	NPN	Cable, SVO-65 / SMT-65()

Servo Test Panel

ASI-348-2

OEM Equivalent: Rockwell Collins MN: NMN PN: NPN Manual: 523-0773831 / 523-0773833 Manual Figure: 903 / 904-905	UUT: SVT-1000A / SVT-1000B SMT-1001 / TSM-1000 / TSM-1001
	Size: H: 3.50" W: 19.00" D: 6.00" Pwr: 28 VDC

Description:
The ASI-348-2 Servo Test Panel works in conjunction with a torque tester (ASI-212-5) to facilitate testing of the Collins SVT-1000A and SVT-1000B Servos.

The ASI-348-2 is equivalent to the Adapter Panel / Servo Test Set shown in the SVT-1000A and SVT-1000B repair manuals. It provides power inputs, discrete controls, and meter test points required during testing and troubleshooting of the servo and servo mount.

The ASI-348-2 includes the SVT-1000A/SMT-1001 test cable (ASI-34-82A) and SVT-1000B/TSM-1000/TSM-1001 test cable (ASI-34-82B). The optional ASI-34-8A test cable will enable the ASI-348-2 to test the SVO-65 Servo.

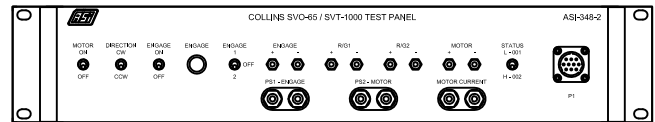

Equipment Supplied:

ASI MN	OEM PN	Description
ASI-34-82A	NPN	Cable, SVT-1000A / SMT-1001
ASI-34-82B	NPN	Cable, SVT-1000B / TSM-1000 / TSM-1001

Optional Equipment:

ASI MN	OEM PN	UUT MANUAL FIGURE	Description
ASI-18-9A	622-6454-002	SVO-65 Table 5-3	SVO-65/75 Mod Kit for 960M-3
ASI-18-9B	634-2835-001	SVO-65 Fig 5-8	SMT-65() Capstan Holding Fixture
ASI-18-9C	634-2830-001	SVO-65 Fig 5-9	SMT-65E Capstan Holding Fixture
ASI-18-9D	01-0296-00	SVO-65 Fig 5-6 / SVT-1000A Fig 907 / SVT-1000B Fig 908	Magnetic Clutch Holding Fixture
ASI-18-9E	647-3825-001	SVO-65 Fig 5-7 / SVT-1000A Fig 906 / SVT-1000B Fig 906	Backlash Test Fixture (Requires 80-144 Dial Ind)
ASI-34-8A	NPN	SVO-65 Fig 5-11	SVO-65 Test Cable
ASI-34-8B	135-3602-961	SVO-65 Fig 5-4A	Ball Bearing Inner Race Removal Tool
ASI-34-8C	135-3602-122	SVO-65 Fig 5-4B	Ball Bearing Assembly Fixture
ASI-34-82C	827-1543-001	SVT-1000A Fig 908 / SVT-1000B Fig 914	Clutch Testing Fixture
ASI-34-82D	634-1942-001	SVT-1000B Fig 103	TSM-1001 Capstan Locking Fixture
ASI-34-82E	634-1943-001	SVT-1000A Fig 102	SMT-1001 Capstan Locking Fixture
ASI-34-82F	634-1785-001	SVT-1000B Fig 102	TSM-1000 Capstan Locking Fixture
ASI-40-31B	634-1729-001	SVT-1000B Fig 910	Half Clutch Depth Gauge (Req 25-243 and 6632-5)
ASI-40-31C	634-1728-001	SVT-1000B Fig 911	Mount Clutch Depth Gauge
ASI-40-31D	634-1772-002	SVT-1000B Fig 909	TSM-1000 Backlash Test Fixture (Req 25-241J)
ASI-40-31G	01-0294-00	SVT-1000B Fig 913	Mount Clutch Preload Fixture
ASI-212-3	622-2741-001	SVO-65 Fig 5-2	Torque Tester (960M-3) Requires ASI-18-9A Mod Kit
ASI-212-5	622-6454-001	SVT-1000A Fig 905 / SVT-1000B Fig 903	Torque Tester (960M-5) Includes ASI-18-9A Mod Kit
ASI-246-2	621-9185-002	SVT-1000A Fig 102	Capstan Test Fixture
ASI-249	676-1949-001	N/A	Servo Mount Run-In Fixture
ASI-21-24C	634-1723-001	SVT-1000B Fig 907	Capstan Adjustment Wrench
ASI-21-24A	634-1773-001	SVT-1000B Fig 907	Capstan Torque Adjustment Fixture

5082-1/5088-1/5289-1 Test Panel**ASI-349-1****Description of Operation:**

The ASI-349-1 Test Panel allows testing of the Avtech 5082-1, 5088-1, and 5289-1 avionics units.

Equivalent OEM: Avtech

Equivalent MN: 2482-1/2488-1/TR5289-1

Equivalent PN:

Units Tested:

5082-1 PAA

5088-1 ICU

5289-1 ACU

The ASI-349-1 combines the functions from three Avtech test fixtures into one rack mountable test panel.

Equipment Supplied:

ASI-34-91A

Cable: ASI-349-1 to 5088-1

ASI-34-91B

Cable: ASI-349-1 to 5082-1

ASI-34-91C

Cable: ASI-349-1 to 5264-1

The test panel is wired directly to the Avtech schematics and will test the uut "by the book" using the test procedures in the uut maintenance manual.

Optional Equipment**Equipment Specifications:**

Height: 8.75" Width: 19.00" Depth: 6.00"

5264-1 Test Panel**ASI-349-2****Description of Operation:**

The ASI-349-2 Test Panel allows testing of the Avtech 5264-1 Electronics Unit.

Equivalent OEM: Avtech

Equivalent MN: TR5289-1

Equivalent PN:

Units Tested:

5264-1 EU

The ASI-349-2 requires a 5088-1 ICU, two 5289-1 ACU's, and two 5083-1 handset/cradle assemblies (all five user supplied) for proper operation.

Equipment Supplied:

ASI-34-92A (Qty-2)

Cable: ASI-349-2 to 5083-1

ASI-34-92B

Cable: ASI-349-2 to 5264-1

The test panel is wired directly to the Avtech schematic and will test the uut "by the book" using the test procedures in the uut maintenance manual.

Optional Equipment**Equipment Specifications:**

Height: 8.75" Width: 19.00" Depth: 6.00"

5261-1/5260-60 Test Panel**ASI-349-3****Description of Operation:**

The ASI-349-3 Test panel allows testing of the 2361-1 ACP and the 5260-60 Station Card.

Equivalent OEM: Avtech

Equivalent MN: 2361-1/TR5260-40-9

Equivalent PN:

Units Tested:

5261-1 ACP

5260-60 Station Card

The ASI-349-3 combines the functions from two Avtech test fixtures into one rack mountable test panel.

Equipment Supplied:

ASI-34-93A

Cable: ASI-349-3 to 5260-60

ASI-34-93B

Cable: ASI-349-3 to 5261-1

The test panel is wired directly to the Avtech schematics and will test the uut "by the book" using the test procedures in the uut maintenance manual.

Optional Equipment**Equipment Specifications:**

Height: 8.75" Width: 19.00" Depth: 6.00"

5260-1 Test Panel**ASI-349-4****Description of Operation:**

The ASI-349-4 Test Panel allows testing of the Avtech 5260-1 Audio Remote Electronics Unit.

Equivalent OEM: Avtech

Equivalent MN: TR5260-1

Equivalent PN:

Units Tested:

5260-1 AREU

The ASI-349-4 requires three 5261-1 ACP's (user supplied) for proper operation.

Equipment Supplied:

The test panel is wired directly to the Avtech schematics and will test the uut "by the book" using the test procedures in the uut maintenance manual.

Optional Equipment**Equipment Specifications:**

Height: 14.00" Width: 19.00" Depth: 10.00"

REV 2
3-1-88

Audio Control Panel Test Set

ASI-349-5AV

OEM Equivalent: Avtech
 MN: 2020-1-1
 PN: 2020-1-1
 Manual: 23-44-02 / 23-50-38 / 23-51-23
 Manual Figure: 9001 / 9001 / 9001

UUT: 5141-1-X / 5144-1-X / 5145-1-XX
 10-62090-XX
 Size: H: 12.00" W: 12.00" D: 3.00"
 Pwr: 5 VAC and 115/220 VAC

Description:
 The ASI-349-5AV Audio Control Panel Test Set functions to test and troubleshoot the Avtech 5141-1-X, 5144-1-X, and 5145-1-XX Series of Audio Control Panels (Boeing 10-62090-XX).

Testing 5145-1-42/45/66/69/73/76/78 Audio Controls Panels with SELCAL / ACARS capability requires the optional ASI-349-50 Test Adapter.

Testing 5145-1-74/77 Audio Control Panels with SELCAL / ACARS / SATCOM capability requires the optional ASI-349-51 Test Adapter.

The ASI-349-5AV is supplied with the LRU test cable (ASI-34-95A) and a 115 to 220 VAC plug adapter (30110).

Equipment Supplied:

ASI MN	OEM PN	Description
ASI-34-95AVA	NPN	Cable, ASI-349-5AV to 5141 / 5144 / 5145
30110	30110	AC Plug Adapter, 115 to 220 VAC

Optional Equipment:

ASI MN	OEM PN	Description
ASI-349-50	2020-1-1	Audio Control Panel Test Adapter
ASI-349-51	2020-1-2	Audio Control Panel Test Adapter

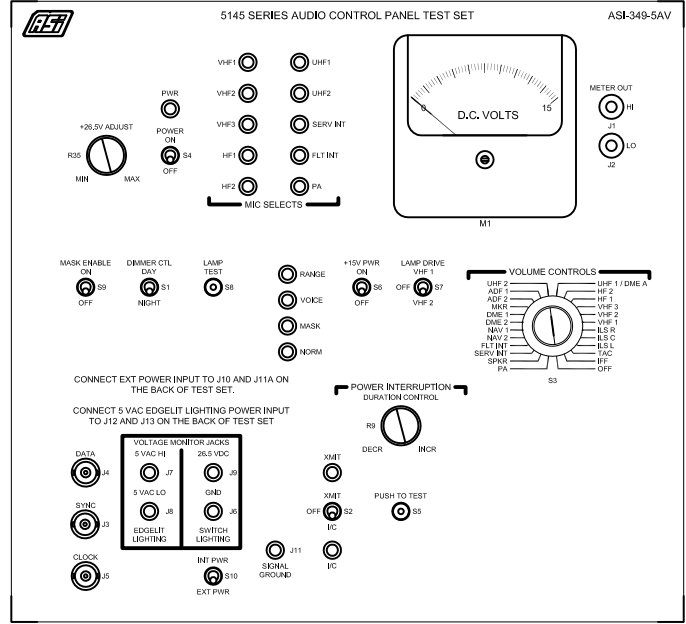

Audio Control Panel Test Adapter

ASI-349-50

OEM Equivalent: Avtech
 MN: 2020-1-1
 PN: 2020-1-1
 Manual: 23-50-38
 Manual Figure: 9003

UUT: 5145-1-42/45/66/69/73/76/78
 10-62090-42/45/66/69/73/76/78
 Size: H: 7.00" W: 9.00" D: 2.00"
 Pwr: N/A

Description:
 The ASI-349-50 Audio Control Panel Test Adapter works in conjunction with the ASI-349-5 to test the SELCAL / ACARS functions of the Avtech 5145-1-42/45/66/69/73/76/78 Audio Control Panels.

The ASI-349-50 interfaces with the LRU with an attached pendant cable.

Equipment Supplied:

ASI MN	OEM PN	Description
ASI-349-5AV	2020-1-AV	Audio Control Panel Test Set

Optional Equipment:

ASI MN	OEM PN	Description
ASI-349-5AV	2020-1-AV	Audio Control Panel Test Set

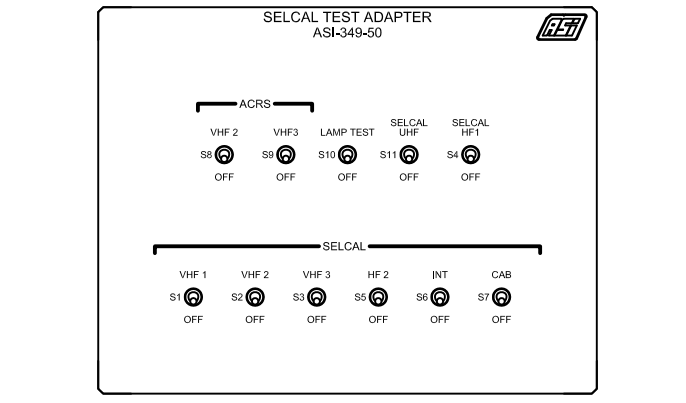

Audio Control Panel Test Adapter

ASI-349-51

OEM Equivalent: Avtech
 MN: 2020-1-2
 PN: 2020-1-2
 Manual: 23-50-61 / 23-50-74
 Manual Figure: 104 / 104

UUT: 5145-1-74/77
 10-62090-74/77
 Size: H: 7.00" W: 9.00" D: 2.00"
 Pwr: 28 VDC

Description:
 The ASI-349-51 Audio Control Panel Test Adapter works in conjunction with the ASI-349-5 to test the SELCAL / ACARS / SATCOM functions of the Avtech 5145-1-74/77 Audio Control Panels.

The ASI-349-51 interfaces with the LRU with an attached pendant cable.

Equipment Supplied:

ASI MN	OEM PN	Description
ASI-349-5AV	2020-1-AV	Audio Control Panel Test Set

Optional Equipment:

ASI MN	OEM PN	Description
ASI-349-5AV	2020-1-AV	Audio Control Panel Test Set

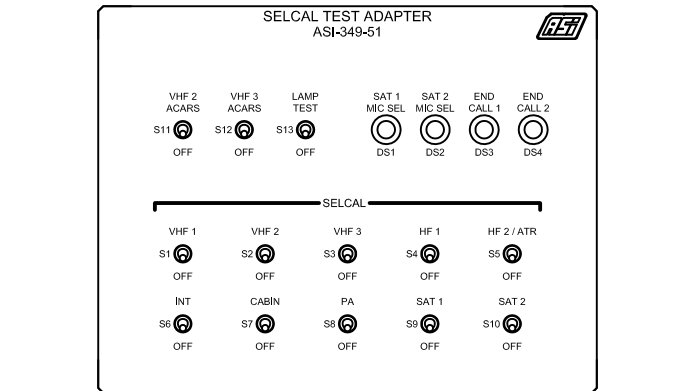

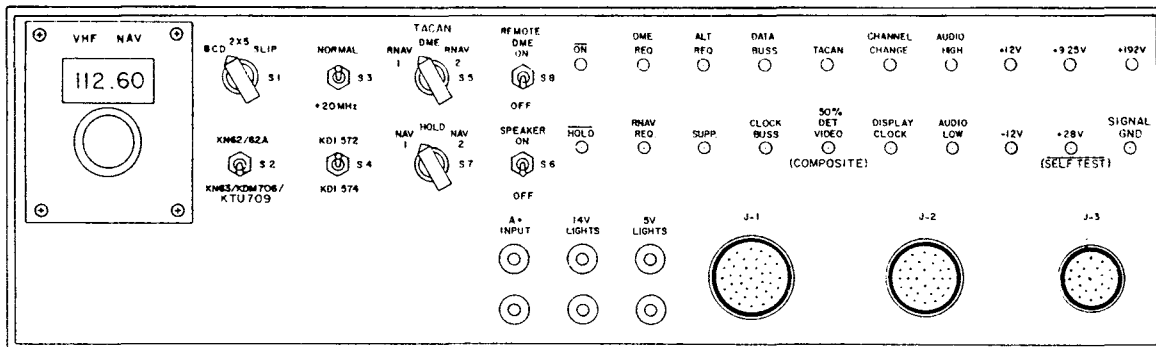

This unit is manufactured to replace the OEM model and/or part number listed below in form, fit, and function.

Equivalent OEM: King

Equivalent MN:

Equivalent PN:

Manual Figure: KDI-572 / -573 / -574 Fig. 5-1A

KDM-706 Fig. 5-1A - 5-1B

KN-62 / -62A / -64 Fig. 6-1

KN-63 Fig. 5-1 - 5-1A

KTU-709 Fig. 5-1B - 5-2

Units Tested:

KDI-572 / -573 / -574

KDM-706

KN-62 / -62A

KN-63

KN-64

KTU-709

Description of Operation:

The ASI-357 Test Panel facilitates testing of King DME and TACAN avionics systems. The ASI-357 is a direct replacement for the King DME Test Panel and will test the KDM-706, KN-62, KN-63, KN-64, and KTU-709 "by the book". The ASI-357 will also test the KDI-572, KDI-573, KDI-574 DME indicators.

The ASI-357 requires a BCD/2X5 Control Head (KFS-560B) and a Slip Code Control Head (KX-170A / -170B, KX-175A / -175B, or KFS-562) for proper operation. Both of the control heads are user supplied.

Cables required for testing are listed below under optional equipment.

Specifications:

Height: 5.25" Width: 19.00" Depth: 6.00" Power: 11-33 VDC Adjustable

Equipment Supplied:

ASI MN	Equivalent PN	Description
--------	---------------	-------------

Optional Equipment:

ASI MN	Equivalent PN	Description
ASI-35-7A		Cable: ASI-357 to KDM-706 / KTU-709
ASI-35-7B		Cable: ASI-357 to KN-62 / -62A / -64
ASI-35-7C		Cable: ASI-357 to KN-63
ASI-35-7D		Cable: ASI-357 TO KDI-572 / -574
ASI-35-7E		Cable: ASI-357 to KDI-573
ASI-35-7F		Cable: ASI-357 to KFS-562
ASI-35-7G		Cable: ASI-357 to KX-170A / -170B / -175A / -175B

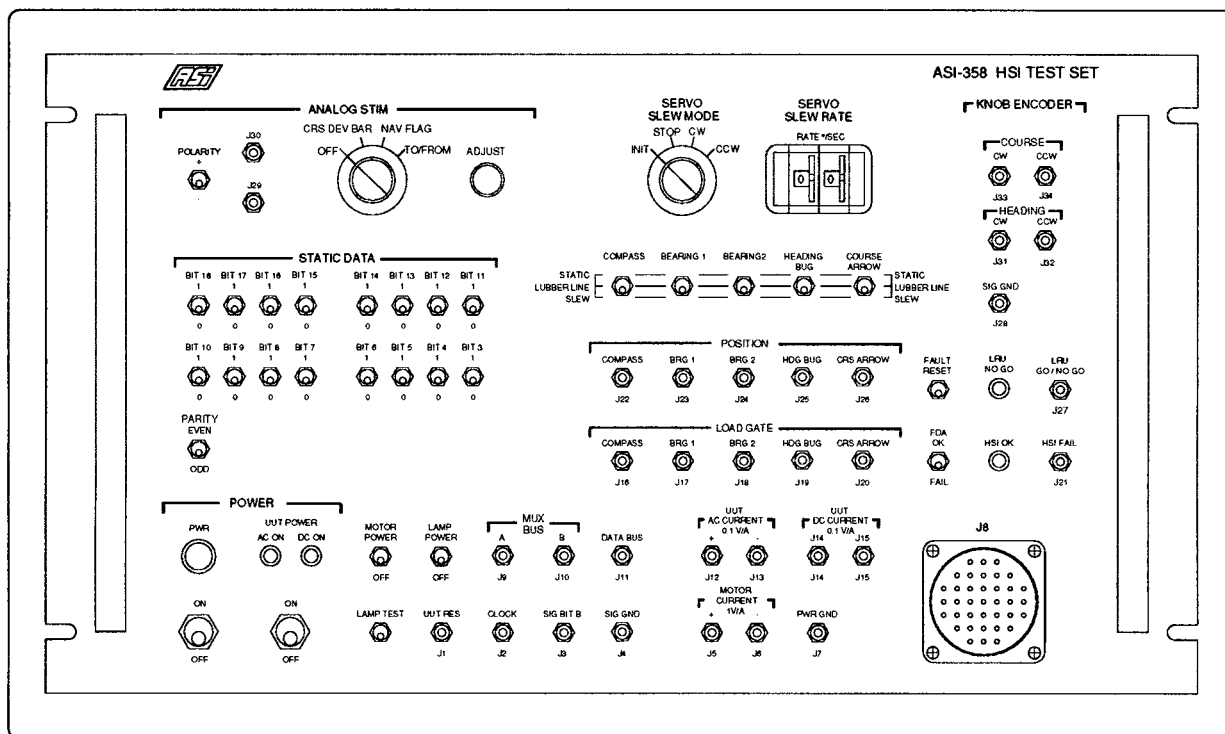

This unit is manufactured to replace the OEM model and/or part number listed below in form, fit, and function.

Equivalent OEM: Collins
 Equivalent MN: 969Y-1
 Equivalent PN: 622-5359-001
 Manual Figure:

Units Tested:
 331D-7 (622-0290-004)

Description of Operation:

The ASI-358 test panel provides an interface for testing and troubleshooting of the Collins 331D-7 Horizontal Situation Indicator. The ASI-358 interface includes UUT power switching, operating mode selection, data setup switches for the UUT, as well as voltmeter or oscilloscope test points, various load resistors, and status display switches.

The ASI-358 is supplied with UUT cable Extender cards for the UUT modules are optional.

Specifications:

Height: 10.5" Width: 19.00" Depth: 19.00"

Power: 115 VAC 60/400 Hz

Equipment Supplied:

ASI MN	Equivalent PN	Description
ASI-35-8A	634-9812-001	Cable: ASI-358 to 331D-7

Optional Equipment:

ASI MN	Equivalent PN	Description
ASI-35-8B	622-2274-001	Extender Card, A6
ASI-35-8C	622-2275-001	Extender Card, A4
ASI-35-8D	622-2276-001	Extender Card, A3
ASI-35-8E	622-2277-001	Extender Card, A5

Radar System Test Panel

ASI-360

OEM Equivalent:

OEM: Bendix
 Model Number:
 Part Number:
 Manual:
 Manual Figure:

This unit is manufactured to replace the OEM MN, PN, and/or manual figure listed in Form, Fit, and Function.

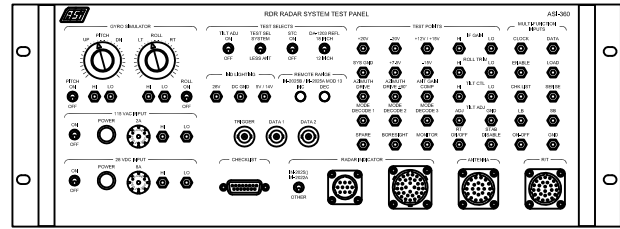

Description:

The ASI-360 Radar System Test Panel provides a self contained means of testing the Bendix RDR-1X0/1XX0 series of Weather Radar Systems. The ASI-360 directly replaces the radar system test harness shown in the various RDR manuals.

The ASI-360 includes a gyro simulator, test points, switching, power and interconnection required to test the RDR systems.

The ASI-360 includes four interface cables required to interconnect the RT, Antenna, and Indicator for testing.

Units Tested:

- RDR-130 (RT-131A / AT-133A / DA-144A / IN-2026A / IN-132A / IN-152A)
- RDR-140 (RT-1201A / AT-143A / IN-1202A)
- RDR-150 (RT-131A / IN-2026A)
- RDR-160 (ART-161A / IN-152A / IN-2026A)
- RDR-1100 (RT-131A / DA-1203A / IN-2027A)
- RDR-1150 (RT-1151A / DA-1203A / IN-1152A/B)
- RDR-1200 (RT-1201A / DA-1203A / IN-1202A)
- RDR-1300 (RT-1301A / RT-1301B / DA-1203A / IN-2022A)
- RDR-1400B (RT-1401B / DA-1203A / IN-2025A)
- RDR-1400C (RT-1401B / DA-1203A / IN-2025B)

Specifications:

Height: 7.00" Width: 19.00" Depth: 6.00
 Power Requirements: 115 VAC 400 Hz / 27.5 VDC

Equipment Supplied:

ASI MN	OEM PN	Description
ASI-36-0A	NPN	Cable, ASI-360 to RT
ASI-36-0B	NPN	Cable, ASI-360 to Antenna
ASI-36-0C	NPN	Cable, ASI-360 to Indicator
ASI-36-0D	NPN	Cable, ASI-360 to Indicator (Multifunction)

Optional Equipment:

ASI MN	OEM PN	Description
ASI-36-0E	NPN	Cable, ASI-360 to ART-161A
ASI-488	TS-488A/UP	Echo Box (Modified)
ASI-1207A	4000595-0701	Radar Test Set (TS-1207A)

Radar Test Set

ASI-1207A

OEM Equivalent:

OEM: Bendix
 Model Number: TS-1207A
 Part Number: 4000595-0701
 Manual: I.B. 21200A Part 4
 Manual Figure: 1-1, 1-2

This unit is manufactured to replace the OEM MN, PN, and/or manual figure listed in Form, Fit, and Function.

Description:

The ASI-1207A Radar Test Set is a portable test unit that interfaces with the Bendix RT-1201/RT-1301/RT-1401/RT-1501 Receiver Transmitters.

The Test Set cable plugs into the R/T ATE connector. A function switch selects the input parameters to the test set meter for monitoring purposes. Functions monitored include crystal currents and +20 VDC power supply. The analog video output of the receiver is also available at the BNC connector located on the top of the test set. This analog video output is always available and is independent of the function selector switch position.

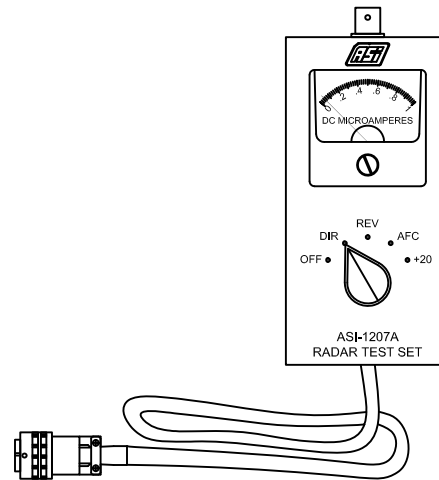

Units Tested:

- RT-1201A
- RT-1301A / RT-1301B
- RT-1401A / RT-1401B
- RT-1501A

Specifications:

Height: 5.00" Width: 2.25" Depth: 2.25"
 Power Requirements: From UUT

Equipment Supplied:

ASI MN	OEM PN	Description
--------	--------	-------------

Optional Equipment:

ASI MN	OEM PN	Description
ASI-360	NPN	RDR Radar System Test Panel
ASI-426	3614129-1501	RDR-1500 Radar System Test Panel

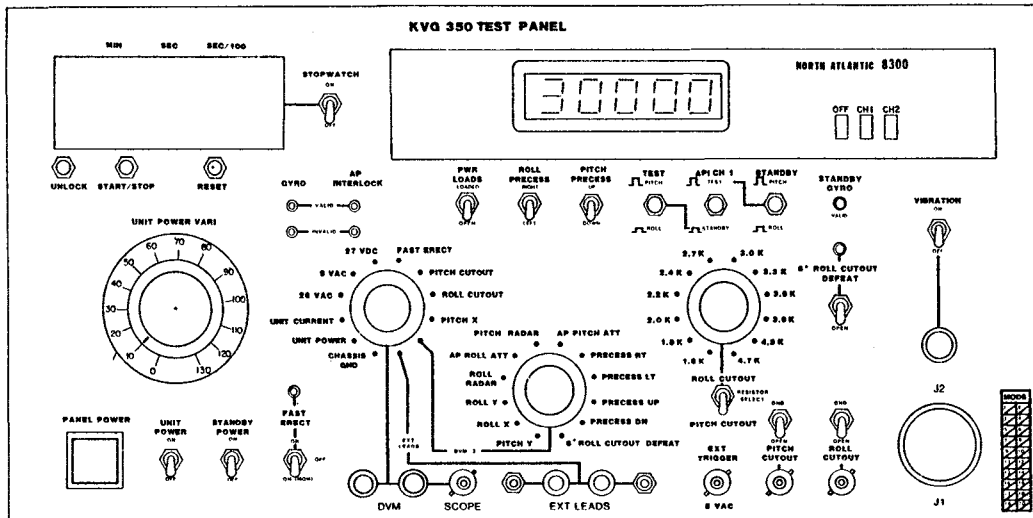

This unit is manufactured to replace the OEM model and/or part number listed below in form, fit, and function.

Equivalent OEM: King

Units Tested:

Equivalent MN:

KVG-350 Vertical Gyro

Equivalent PN: 696-4825-00

Manual Figure: KVG-350 Manual Fig. 5-2

Description of Operation:

The ASI-361 Gyro Test Panel provides functions required to test, align, and repair the King KVG-350 Vertical Gyro. The test panel requires a user supplied digital synchro angle position indicator (North Atlantic 8300 or equivalent) for proper operation.

The ASI-361 includes one test cable. An optional run-in cable is available (The ASI-361 has the ability to run-in one gyro while testing another).

Specifications:

Height: 7.00 Width: 19.00" Depth: 6.00"

Power: 115 VAC 400 Hz

Equipment Supplied:

ASI MN	Equivalent PN	Description
ASI-36-1A		Cable: KVG-350 Test Cable

Optional Equipment:

ASI MN	Equivalent PN	Description
ASI-36-1B		Cable: KVG-350 Run-In Cable

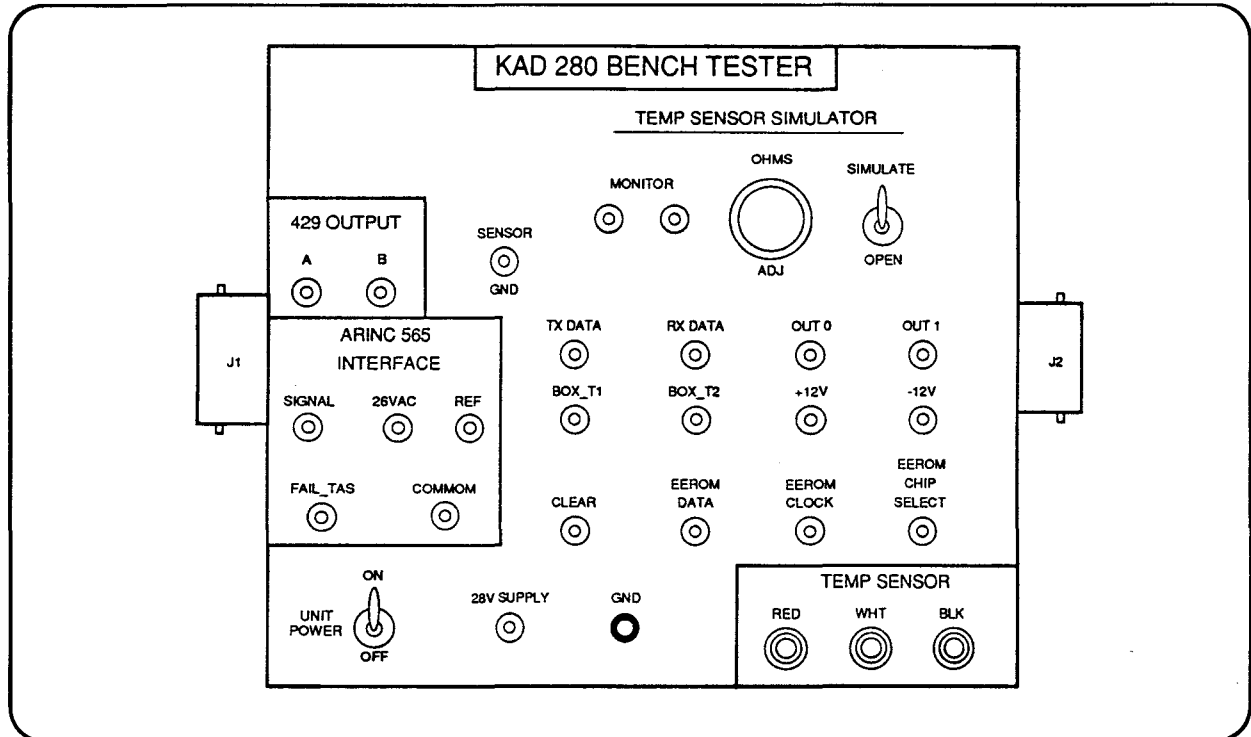

This unit is manufactured to replace the OEM model and/or part number listed below in form, fit, and function.

Equivalent OEM: Bendix / King

Equivalent MN:

Equivalent PN: 696-05641-0001 / -0002 (Dwg. No.)

Manual Figure: KAD-280 Manual Fig. 5-1 - 5-3

Units Tested:

KAD-280 (KDC-281 / KPS-282 / KTS-283)

Description of Operation:

The ASI-362 Test Set provides switching, loads and interconnection required for testing the King KAD-280 Air Data System consisting of the KDC-281 Air Data Computer, KPS-282 Air Data Pressure Sensor, and the KTS-283 Air Data Temperature Sensor.

The ASI-362 is supplied with two cables (ASI-36-2A / ASI-36-2B) and three load resistors (250Ω / 430Ω / 25 Ω).

Specifications:

Height: 3.00" Width: 7.00" Depth: 5.00"

Power: 28 VDC

Equipment Supplied:

ASI MN	Equivalent PN	Description
ASI-36-2A	P/O 696-05641-0003	Cable: ASI-362 to KDC-281
ASI-36-2B	P/O 696-05641-0003	Cable: ASI-362 to KPS-282
		Load Res: 250Ω 1% 1/4W
		Load Res: 430Ω 1% 1/4W
		Load Res: 25Ω 1% 1/4W

Optional Equipment:

ASI MN	Equivalent PN	Description
--------	---------------	-------------

Relay Control Module Test Panel

ASI-367-1

Description of Operation:

The ASI-367-1 Relay Control Module Test Panel tests the relay assembly group module used in the Collins 309A-9/9A Antenna Coupler Control.

The test panel cycles the module being tested to each of six modes, tests circuits and components, and monitors their operation. Correct operation is indicated on the front panel via 10 green verification lamps and 10 amber program lamps.

The module being tested connects directly to the front of the test panel. The ASI-36-71A test cable is supplied to facilitate troubleshooting of defective modules.

Equivalent OEM: Collins
Equivalent MN: 878L-13
Equivalent PN: 522-3971-001

Units Tested:
309A-9/9A

Equipment Supplied:

ASI-36-71A Cable: ASI-367-1 to Module

Optional Equipment

ASI-367-2 Servo Amplifier Module Test Panel
ASI-367-3 Discriminator Module Test Panel

Equipment Specifications:

Height: 5.25" Width: 19.00" Depth: 6.50"

Servo Amplifier Module Test Panel

ASI-367-2

Description of Operation:

The ASI-367-2 Servo Amplifier Module Test Panel checks the electronic control amplifier module used in the Collins 309A-9/9A Antenna Coupler Control.

The test panel simulates and directs two different inputs and presents an operational load to the module. The performance of the module is measured and indicated on the front panel mounted torque indicator.

The module being tested connects directly to the front of the test panel.

Equivalent OEM: Collins
Equivalent MN: 878L-18
Equivalent PN: 522-4409-001

Units Tested:
309A-9/9A

Equipment Supplied:

Optional Equipment

ASI-367-1 Relay Control Module Test Panel
ASI-367-3 Discriminator Module Test Panel

Equipment Specifications:

Height: 5.25" Width: 19.00" Depth: 6.50"

Discriminator Module Test Panel

ASI-367-3

Description of Operation:

The ASI-367-3 Discriminator Module Test Panel provides a convenient means to test and adjust the loading-phasing module used in the Collins 180R-12 Antenna Coupler.

The test panel provides appropriate loading and phasing elements to the transmission line, simulating balanced and unbalanced conditions. A panel mounted microammeter monitors the reaction of the module to these test conditions.

The module being tested connects directly to the front of the test panel. A shielded housing adapter (ASI-36-73B) is provided to allow access to module alignment adjustments under shielded conditions.

Equivalent OEM: Collins
Equivalent MN: 878L-19
Equivalent PN: 522-4410-001

Units Tested:
180R-12

Equipment Supplied:

ASI-36-73A Cable: RF Coax
ASI-36-73B Adapter: Shielded Housing for Module

Optional Equipment

ASI-367-1 Relay Control Module Test Panel
ASI-367-2 Servo Amplifier Module Test Panel

Equipment Specifications:

Height: 5.25" Width: 19.00" Depth: 7.25"

10-1-97

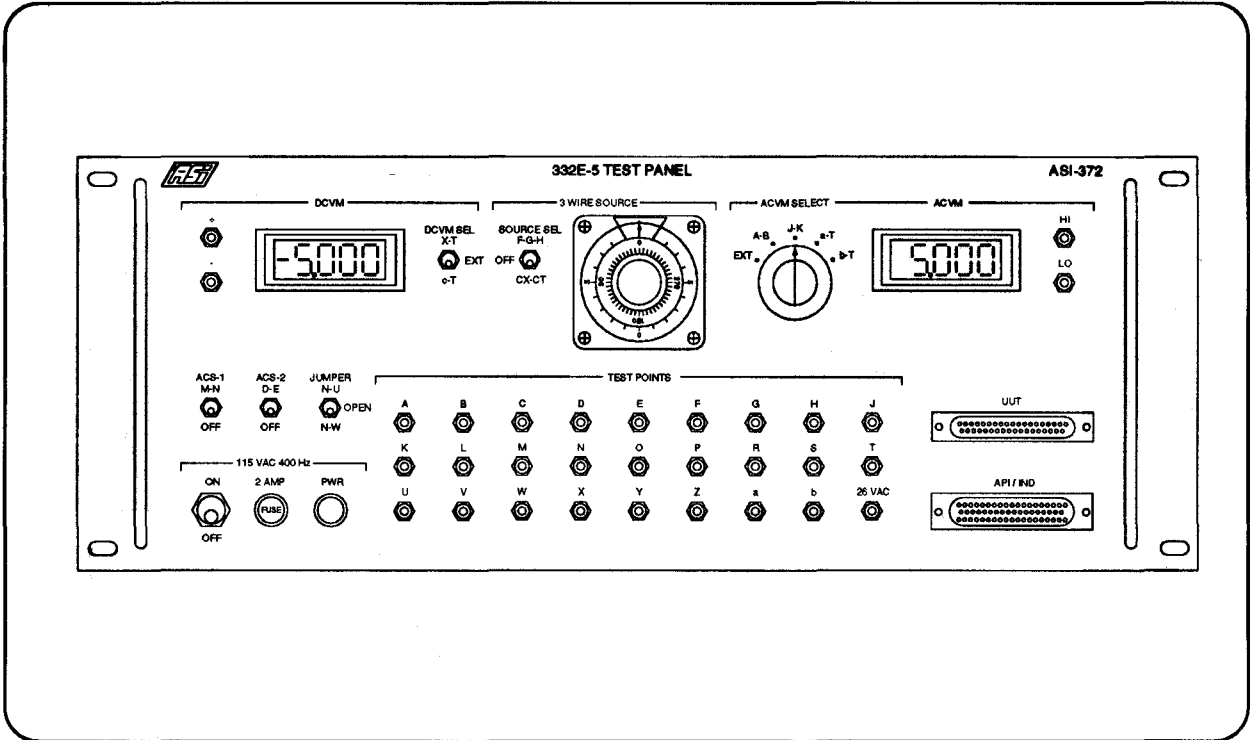

This unit is manufactured to replace the OEM model and/or part number listed below in form, fit, and function.

Equivalent OEM: Collins
 Equivalent MN:
 Equivalent PN:
 Manual Figure:

Units Tested:
 332E-5

Description of Operation:

The ASI-372 Gyro Test Panel provides a self contained, cost effective means of testing and troubleshooting the Collins 332E-5 Gyro. The ASI-372 follows the test procedures in the Collins 332E-5 overhaul manual.

The test panel includes power, AC and DC meters, 3 wire source, switching and test points required when testing the 332E-5 Gyro.

The ASI-372 comes complete with a uut interface cable for the 332E-5. Optional cables to interface a 332C-8 Indicator or API (Angle Position Indicator) are also available (Indicator and API are not required for testing).

Specifications:

Height: 7.00" Width: 19.00" Depth: 6.00" Power: 115 VAC 400 Hz

Equipment Supplied:

ASI MN	Equivalent PN	Description
ASI-37-2A		Cable: ASI-372 to Collins 332E-6 Gyro

Optional Equipment:

ASI MN	Equivalent PN	Description
ASI-37-2B		Cable: ASI-372 to Collins 332C-8 RMHI
ASI-37-2C		Cable: ASI-372 to API (DDC SR-103 or equivalent)

ADF Test Panel

ASI-375-1

OEM Equivalent: Rockwell Collins
MN: 970G-2
PN: 622-7345-001
Manual: 523-0774479
Manual Figure: 1

UUT: DF-206A / AN/ARN-149(V)
DFR-206A / R-2382 / R-2383
DFC-206A / C-11927 / C-12192 / C-12491
DFA-206A / AS-3933 / AS-3934 / AS-4480

Size: H: 10.50" W: 19.00" D: 12.00"
Pwr: 115 VAC 400Hz

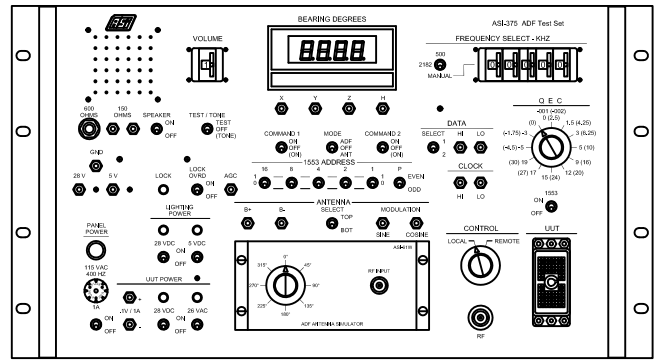

Description:

The ASI-375-1 ADF Test Panel provides testing and fault isolation of the Collins DF-206A and AN/ARN-149(V) ADF Systems. The test panel acts as an interface and contains the ability to provide stimuli and measure data required when testing the ADF system. Testing of 1553B equipped ADF Receivers requires the optional 1553 Bus Adapter (ASI-37-5D) or the ASI-375-2 ADF Test Panel.

The ASI-375-1 includes the ASI-61W (970W-1) ADF Antenna Simulator, ASI-37-5A I/O Cable, ASI-37-5B Antenna Cable, and ASI-37-5C RF Attenuator.

Equipment Supplied:

ASI MN	OEM PN	Description
ASI-37-5A	659-3486-001	Cable, ADF Receiver / Control (W1)
ASI-37-5B	659-3483-001	Cable, ADF Antenna (W2)
ASI-37-5C	687-7724-001	RF Attenuator
ASI-61W	622-3099-001	ADF Antenna Simulator (970W-1)

Optional Equipment:

ASI MN	OEM PN	Description
ASI-18-5C	687-7902-001	Dual ADF Antenna Adapter Cable
ASI-37-5D	687-7931-001	1553B Bus Adapter
ASI-278	622-3874-001	ADF Antenna Tester (969W-1)

ADF Test Panel

ASI-375-2

OEM Equivalent: Rockwell Collins
MN: 970G-2
PN: 622-7345-002
Manual: 523-0774479
Manual Figure: 1

UUT: DF-206A / AN/ARN-149(V)
DFR-206A / R-2382 / R-2383
DFC-206A / C-11927 / C-12192 / C-12491
DFA-206A / AS-3933 / AS-3934 / AS-4480

Size: H: 10.50" W: 19.00" D: 12.00"
Pwr: 115 VAC 400Hz

Equipment Supplied:

ASI MN	OEM PN	Description
ASI-37-5A	659-3486-001	Cable, ASI-375 to ADF Receiver / Control (W1)
ASI-37-5B	659-3483-001	Cable, ASI-375 to ADF Antenna (W2)
ASI-37-5C	687-7724-001	RF Attenuator
ASI-37-5D	687-7931-001	1553B Bus Adapter
ASI-61W	622-3099-001	ADF Antenna Simulator (970W-1)

Description:

The ASI-375-2 Test Panel is similar to the ASI-375-1 except that it is supplied with the 1553B Bus Adapter (ASI-37-5D).

Optional Equipment:

ASI MN	OEM PN	Description
--------	--------	-------------

VOR/ILS Test Panel

ASI-376-1

OEM Equivalent: Rockwell Collins
MN: 966Y-2
PN: 622-6926-001
Manual: 523-0774091
Manual Figure: 1

UUT: AN/ARN-144(V) / AN/ARN-147(V)
R-2274/R-2325/R-2592/R-2593/R-2594
VIR-130A / VIR-130C

Size: H: 14.00" W: 19.00" D: 16.50"
Pwr: 115 VAC 400Hz

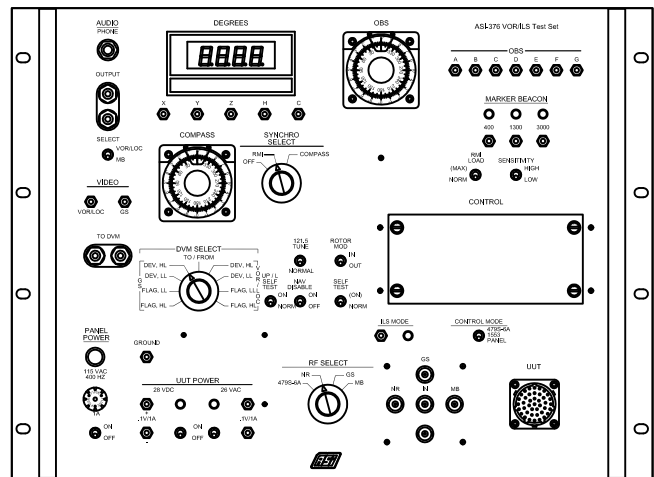

Description:

The ASI-376-1 ADF Test Panel provides testing and fault isolation of the Collins AN/ARN-144, AN/ARN-147(V), and VIR-130A/C VOR/ILS Receivers. The Test Panel acts as an interface and contains the ability to provide stimuli and measure data required when testing the VOR/ILS system. A user supplied control (313N-6C or equivalent) is required for complete testing of the Receiver. Testing of 1553B equipped VOR/ILS Receivers require the optional 1553B Bus Adapter (ASI-37-6D) or the ASI-376-2 VOR/ILS Test Panel.

The ASI-376-1 includes the I/O Cable (ASI-37-6A), 4 RF Cables (ASI-37-6B1/2/3/4) and a Control Cable (ASI-37-6C).

Equipment Supplied:

ASI MN	OEM PN	Description
ASI-37-6A	659-3597-001	Cable, I/O (W1)
ASI-37-6B1	659-3598-001	Cable, MB (W2)
ASI-37-6B2	659-3598-002	Cable, Y2 (W3)
ASI-37-6B3	659-3598-003	Cable, NR (W6)
ASI-37-6B4	659-3598-004	Cable, GS (W7)
ASI-37-6C	659-3603-001	Cable, Control (W4)

Optional Equipment:

ASI MN	OEM PN	Description
ASI-37-6D	659-3933-001	1553B Bus Adapter
ASI-37-6E	676-6722-001	Interface Cable, ASI-37-6D to DCM-1553
ASI-376-5	676-6715-001	AM-X Adapter

VOR/ILS Test Panel

ASI-376-2

OEM Equivalent: Rockwell Collins
MN: 966Y-2
PN: 622-6926-002
Manual: 523-0774091
Manual Figure: 1

UUT: AN/ARN-144(V) / AN/ARN-147(V)
R-2274/R-2325/R-2592/R-2593/R-2594
VIR-130A / VIR-130C

Size: H: 14.00" W: 19.00" D: 16.50"
Pwr: 115 VAC 400Hz

Equipment Supplied:

ASI MN	OEM PN	Description
ASI-37-6A	659-3597-001	Cable, I/O (W1)
ASI-37-6B1	659-3598-001	Cable, MB (W2)
ASI-37-6B2	659-3598-002	Cable, Y2 (W3)
ASI-37-6B3	659-3598-003	Cable, NR (W6)
ASI-37-6B4	659-3598-004	Cable, GS (W7)
ASI-37-6C	659-3603-001	Cable, Control (W4)
ASI-37-6D	659-3933-001	1553B Bus Adapter

Description:

The ASI-376-2 Test Panel is similar to the ASI-376-1 except that it is supplied with the 1553B Bus Adapter (ASI-37-6D).

The optional ASI-37-6E Interface Cable is only required if using the ASI-376-2 with an Atlantis DCM-1553 Bus Controller.

Optional Equipment:

ASI MN	OEM PN	Description
ASI-37-6E	676-6722-001	Interface Cable, ASI-37-6D to DCM-1553
ASI-376-5	676-6715-001	AM-X Adapter

R8

Amplifier Test Panel		ASI-377-1	
OEM Equivalent: Rockwell Collins MN: 978F-4A PN: 522-3427-000 Manual: 523-0757950 Manual Figure: 1-1	UUT: FD-108/109 Amplifiers / Computers 344C-1() / 562P-1() / 562R-1()	Equipment Supplied:	
	Size: H: 10.50" W: 19.00" D: 4.00" Pwr: 115 VAC 400 Hz	<u>ASI MN</u>	<u>OEM PN</u> <u>Description</u>
Description: The ASI-377-1 works in conjunction with the ASI-377-2 (978F-9A) and a synchro source (ASI-167) to test the instrument amplifiers and steering computers used in the Collins FD-108 / FD-109 Integrated Flight Systems.		Optional Equipment:	
		<u>ASI MN</u>	<u>OEM PN</u> <u>Description</u>
		ASI-40X-9	522-4714-001 Cable, ASI-377-1 to ASI-377-2 (440X-9)
		ASI-40X-22	522-4859-001 Cable, ASI-377-1 to 344C-1D (440X-22)
Amplifier Test Adapter		ASI-377-2	
OEM Equivalent: Rockwell Collins MN: 978F-9A PN: 522-4085-000 Manual: 523-0757951 Manual Figure: 1-1	UUT: FD-108/109 Amplifiers / Computers 344C-1() / 562P-1() / 562R-1()	Equipment Supplied:	
	Size: H: 10.50" W: 19.00" D: 4.00" Pwr: 28 VDC	<u>ASI MN</u>	<u>OEM PN</u> <u>Description</u>
Description: The ASI-377-2 works in conjunction with the ASI-377-1 (978F-4A) and synchro source (ASI-167) to test the instrument amplifiers and steering computers used in the Collins FD-108 / FD-109 Integrated Flight Systems.		Optional Equipment:	
		<u>ASI MN</u>	<u>OEM PN</u> <u>Description</u>
		ASI-40X-8	522-4713-001 Cable, ASI-377-2 to ASI-167 (440X-8)
		ASI-40X-13	522-4716-001 Cable, ASI-377-2 to 562P-1/-1E1/-1P1 (440X-13)
		ASI-40X-16	522-4718-001 Cable, ASI-377-2 to 562R-1/-1E1/-1P1 (440X-16)
		ASI-167	522-3498-000 Synchro Source (978F-2S)
Roll Steering Computer Test Panel		ASI-377-3	
OEM Equivalent: Rockwell Collins MN: 978F-5R PN: 522-3501-000 Manual: 523-0757377 Manual Figure: 1-1	UUT: FD-109 Roll Steering Computers 562A-5() / 562R-1()	Equipment Supplied:	
	Size: H: 12.25" W: 19.00" D: 4.75" Pwr: 28 VDC / 115 VAC 60 and 400 Hz	<u>ASI MN</u>	<u>OEM PN</u> <u>Description</u>
Description: The ASI-377-3 works in conjunction with the ASI-377-4 (978F-10R) to test the roll steering computers used in the Collins FD-109 Integrated Flight System.		Optional Equipment:	
		<u>ASI MN</u>	<u>OEM PN</u> <u>Description</u>
		ASI-40X-14	522-4717-001 Cable, ASI-377-3 to 562A-5F/-5F() (440X-14)
		ASI-40X-1	763-5591-000 Cable, 562A-5F/-F() Logic Module (440X-1)
Roll Steering Computer Test Adapter		ASI-377-4	
OEM Equivalent: Rockwell Collins MN: 978F-10R PN: 522-4086-001 Manual: 523-0759031 Manual Figure: 1-1	UUT: FD-109 Roll Steering Computers 562A-5() / 562R-1()	Equipment Supplied:	
	Size: H: 5.25" W: 19.00" D: 4.50" Pwr: 115 VAC 400 Hz	<u>ASI MN</u>	<u>OEM PN</u> <u>Description</u>
Description: The ASI-377-4 works in conjunction with the ASI-377-3 (978F-5R) to test the roll steering computers used in the Collins FD-109 Integrated Flight System.		Optional Equipment:	
		<u>ASI MN</u>	<u>OEM PN</u> <u>Description</u>
		ASI-40X-2	554-2547-001 Cable, 562R-1/-1E Logic Module (440X-2)
		ASI-40X-15	554-2548-001 Cable, ASI-377-1 to 562R-1/-1E1/-1P1 (440X-15)
Pitch Steering Computer Test Panel		ASI-377-5	
OEM Equivalent: Rockwell Collins MN: 978F-6P PN: 522-3426-000 Manual: 523-0757268 Manual Figure: 1-1	UUT: FD-109 Pitch Steering Computers 562A-5() / 562P-1()	Equipment Supplied:	
	Size: H: 12.25" W: 19.00" D: 4.75" Pwr: 28 VDC	<u>ASI MN</u>	<u>OEM PN</u> <u>Description</u>
Description: The ASI-377-5 works in conjunction with the ASI-377-6 (978F-11P) to test the pitch steering computers used in the Collins FD-109 Integrated Flight System.		Optional Equipment:	
		<u>ASI MN</u>	<u>OEM PN</u> <u>Description</u>
		ASI-40X-10	522-4715-001 Cable, ASI-377-5 to 562A-5F/-5F() (440X-10)
		ASI-40X-1	763-5591-000 Cable, 562A-5F/-5F() Logic Module (440X-1)
Pitch Steering Computer Test Adapter		ASI-377-6	
OEM Equivalent: Rockwell Collins MN: 978F-11P PN: 522-4113-000 Manual: 523-0759033 Manual Figure: 1-1	UUT: FD-109 Pitch Steering Computers 562A-5() / 562P-1()	Equipment Supplied:	
	Size: H: 5.25" W: 19.00" D: 4.50" Pwr: 115 VAC 400 Hz	<u>ASI MN</u>	<u>OEM PN</u> <u>Description</u>
Description: The ASI-377-6 works in conjunction with the ASI-377-5 (978F-6P) to test the pitch steering computers used in the Collins FD-109 Integrated Flight System.		Optional Equipment:	
		<u>ASI MN</u>	<u>OEM PN</u> <u>Description</u>
		ASI-40X-11	554-2549-001 Cable, ASI-377-5 to 562P-1/-1E1/-1P1 (440X-11)
		ASI-40X-12	554-2547-002 Cable, ASI-377-5 to 562P-1/-1E1/-1P1 (440X-12)
Mode Control Test Panel		ASI-377-7	
OEM Equivalent: Rockwell Collins MN: 978F-3M PN: 522-3423-000 Manual: 523-0756722 Manual Figure: 1-1	UUT: FD-109 Flight Director Controls 614E-7 / 614E-8 / 614E-9 / 614E-10	Optional Equipment:	
	Size: H: 5.25" W: 19.00" D: 4.75" Pwr: 28 VDC and 115 VAC 400 Hz	<u>ASI MN</u>	<u>OEM PN</u> <u>Description</u>
Description: The ASI-377-7 works in conjunction with a synchro source (ASI-167) to test the Collins 614E-7/-8/-9/-10 series of flight director controls.			
See the ASI-282 and ASI-40Y-13 for alternate test equipment for the 614E-7/-8/-9/-10.			
		ASI-37-77A	NPN Cable, ASI-377-7 to 614E-10()
		ASI-40X-17	522-4719-001 Cable, ASI-377-7 to ASI-167 (440X-17)
		ASI-40X-18	522-4720-001 Cable, ASI-377-7 to 614E-7C/-8A (440X-18)
		ASI-40X-19	522-4721-001 Cable, ASI-377-7 to 614E-8B/-9B/-9C (440X-19)
		ASI-40X-20	522-4722-001 Cable, ASI-377-7 to 614E-8B/-9B/-9C (440X-20)
		ASI-40X-21	522-4723-001 Cable, ASI-377-7 to 614E-8B/-9B/-9C (440X-21)
		ASI-40X-23	522-4860-001 Cable, ASI-377-7 to 614E-7() (440X-23)
		ASI-167	522-3498-000 Synchro Source (978F-2S)
		ASI-229	NPN 614E-10 MODE SEL Switch Adjustment Fixture

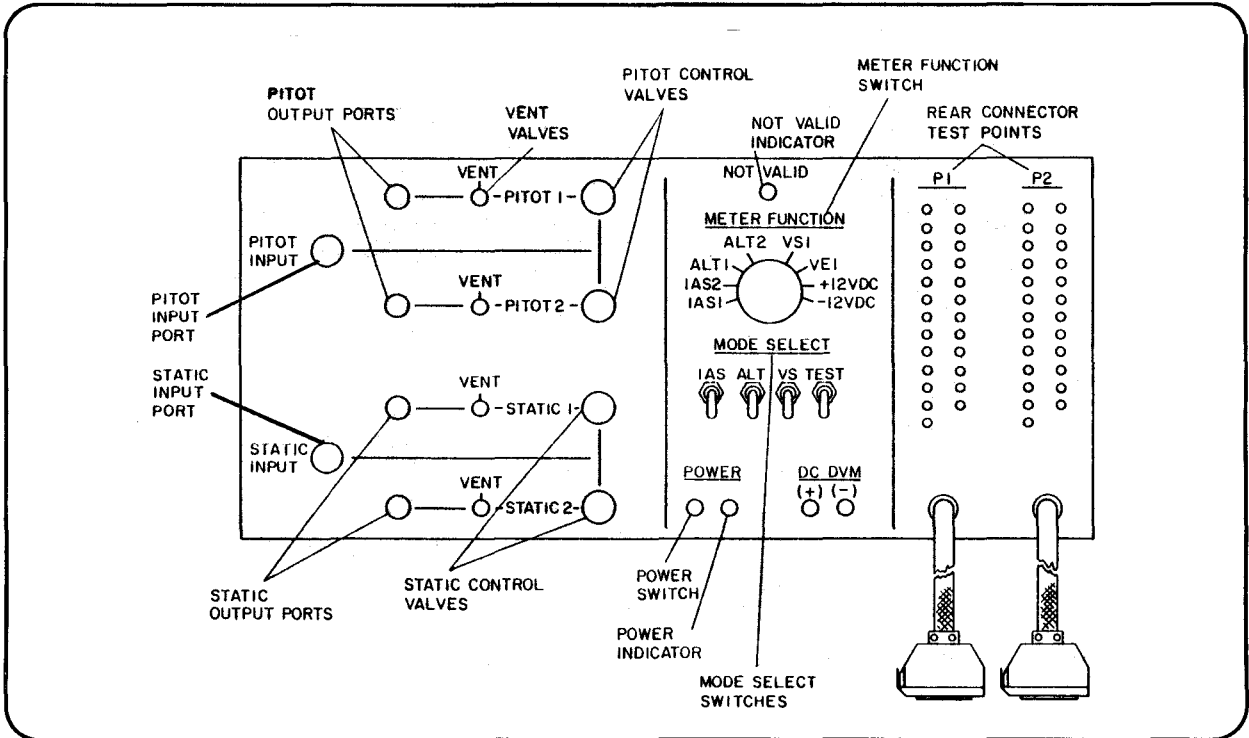

This unit is manufactured to replace the OEM model and/or part number listed below in form, fit, and function.

Equivalent OEM: Collins
 Equivalent MN: CTS-61
 Equivalent PN: 622-6317-001
 Manual Figure:

Units Tested:
 ADS-65
 ADS-65C

Description of Operation:

The ASI-381 Air Data Sensor Test Panel, when used with an altitude pressure source (Ruska DDR-6000-822 or equivalent), provides all signals and pitot/static air pressure necessary to test the operation of the Collins ADS-65/65C Air Data Sensor.

Specifications:

Height: 8.75" Width: 19.00" Depth: 8.00"

Power: 115 VAC 60 Hz / 28 VDC

Equipment Supplied:

ASI MN	Equivalent MN	Description
--------	---------------	-------------

Optional Equipment:

ASI MN	Part Number	Description
nmn	AN815-4D (2 ea)	Pneumatic Adapter: 1/4-in Union
nmn	AN919-6D (2 ea)	Pneumatic Adapter: 3/8 to 1/4 in Reducer
nmn	3-4-S604-70 (2 ea)	O-Ring (cpn 200-2334-190)
nmn	3-906-S604-70 (2 ea)	O-Ring (cpn 200-2334-200)

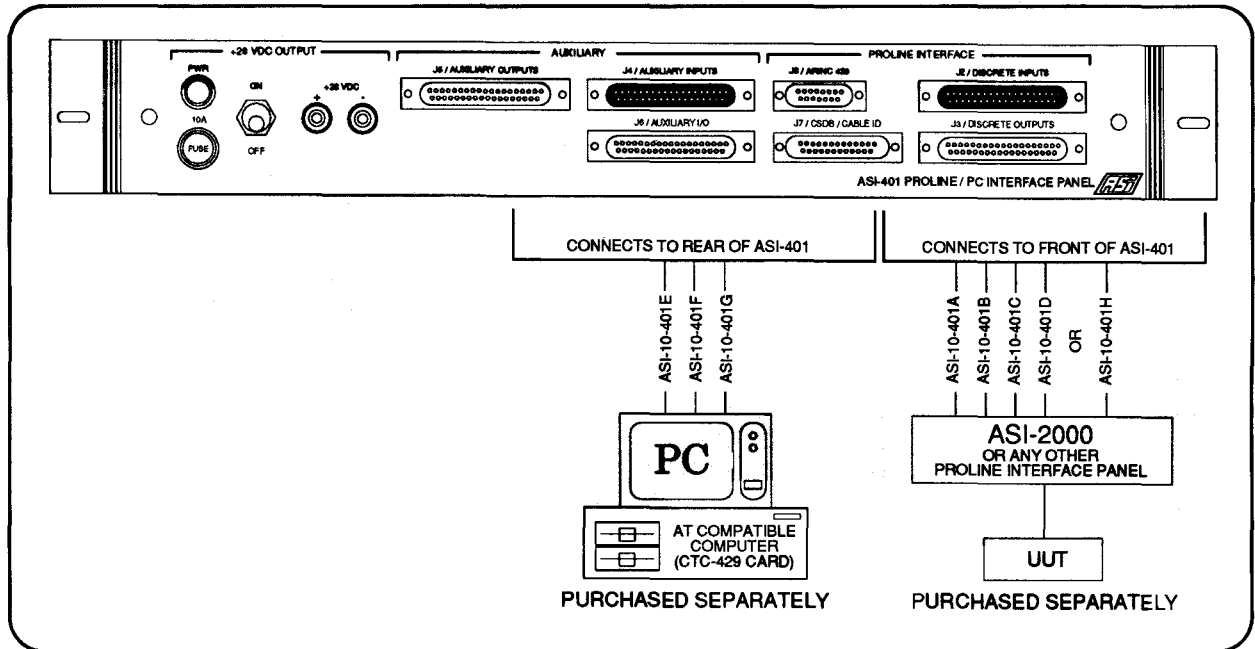

The ASI-401 connects any Pro Line Interface Fixture to a PC (AT compatible computer). This panel will allow the user to convert the Pro Line Interface from the Apple Ile to the newer computer, which is required to run the PC compatible test software available from Collins.

The ASI-401 simply plugs into the Pro Line Interface Fixture, facilitating a quick conversion from the Apple Ile to the PC. No modification of the Pro Line Fixture is required for installation of the ASI-401, thus allowing the user to switch from one computer to another in a matter of minutes.

The Interface Panel is available in three configurations based on cables supplied:

ASI-401-1: Includes interface panel and seven cables required for operation and general installation.

ASI-401-2: Includes interface panel and custom fit cables for operation with ASI-2000 on top of ASI-401.

Note: ASI-2000 must be placed directly on top of ASI-401-2 for cables to mate.

ASI-401-3: Includes interface panel and seven 6 ft cables required for operation and general installation.

The PC requires a Collins CTC-429 CSDB/ARINC 429 Interface Test Card (cpn 822-0854-001) for proper operation. Computer, CTC-429 card, and Pro Line Fixture (ASI-2000 or equivalent) are purchased separately.

Specifications: Height: 2.50" Width: 19.00" Depth: 13.00"

Power: 28 VDC

Equipment Supplied:

QTY	ASI MN	Description	Length	Included With
1	ASI-10-401A	Cable: ASI-401 J2 to Pro Line J3	30"	ASI-401-1
1	ASI-10-401B	Cable: ASI-401 J3 to Pro Line P3	30"	ASI-401-1
1	ASI-10-401C	Cable: ASI-401 J7 to Pro Line P2	30"	ASI-401-1
1	ASI-10-401D	Cable: ASI-401 J8 to Pro Line ARINC 429	30"	ASI-401-1
1	ASI-10-401E	Cable: ASI-401 J10 to CTC-429 card P1	42"	ASI-401-1, ASI-401-2
1	ASI-10-401F	Cable: ASI-401 J12 to CTC-429 card J33	42"	ASI-401-1, ASI-401-2
1	ASI-10-401G	Cable: ASI-401 J14 to CTC-429 card J32	42"	ASI-401-1, ASI-401-2
1	ASI-10-401H	Cable Set: Replaces ASI-10-401A,B,C,D	Custom Fit	ASI-401-2
1	ASI-10-401I	Cable: ASI-401 J2 to Pro Line J3	72"	ASI-401-3
1	ASI-10-401J	Cable: ASI-401 J3 to Pro Line P3	72"	ASI-401-3
1	ASI-10-401K	Cable: ASI-401 J7 to Pro Line P2	72"	ASI-401-3
1	ASI-10-401L	Cable: ASI-401 J8 to Pro Line ARINC 429	72"	ASI-401-3
1	ASI-10-401M	Cable: ASI-401 J10 to CTC-429 card P1	72"	ASI-401-3
1	ASI-10-401N	Cable: ASI-401 J12 to CTC-429 card J33	72"	ASI-401-3
1	ASI-10-401O	Cable: ASI-401 J14 to CTC-429 card J32	72"	ASI-401-3

Optional Equipment:

ASI MN	Equivalent PN	Description
ASI-402	638-0199-001	CTC-429 Serial Loopback Test Fixture (CTC-429 Man. Fig. 5-3)

Primary Servo Test Panel

ASI-403-1 / ASI-403-2

OEM Equivalent: Rockwell Collins
 MN: 972S-5
 PN: 622-7122-001 / 622-7122-002
 Manual: 523-0773367
 Manual Figure: 1-1

UUT: SVO-75 / SVO-85A/85B/85C
 SVO-1000 / SVO-3000

Size: H: 7.00" W: 19.00" D: 7.00"
 Pwr: 115 VAC 60 Hz / 28 VDC

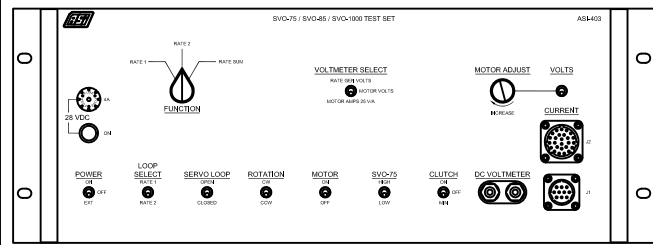

Description:

The ASI-403 Servo Test Panel works in conjunction with a 960M- () Torque Tester (ASI-212-X) to facilitate testing of the Collins SVO-75, SVO-85(), SVO-1000 and SVO-3000 Primary Servos. The Test Panel acts as a flight control or autopilot system substitute for the servo under test by supplying the needed servo operation signals.

The ASI-403 is available in two different configurations:
 ASI-403-1 is equivalent to the Collins 972S-5 / 622-7122-001.
 ASI-403-2 is equivalent to the Collins 972S-5 / 622-7122-002.

ASI-403-1 and ASI-212-5 (960M-5) are required to test the Collins SVO-75.
 ASI-403-1 and ASI-212-4 (960M-4) are required to test the Collins SVO-85().
 ASI-403-1 and ASI-212-5 (960M-5) are required to test the Collins SVO-3000.
 ASI-403-2 and ASI-212-4 (960M-4) are required to test the Collins SVO-1000.

The ASI-403-1 and ASI-403-2 are identical except for the test cables supplied. The ASI-403-1 includes four test cables: ASI-40-3A, ASI-40-3B, ASI-40-3C, ASI-40-3D. The ASI-403-2 includes one test cable: ASI-40-3E.

Equipment Supplied (ASI-403-1):

ASI MN	OEM PN	Description
ASI-40-3A	634-4242-001	Cable, SVO-75
ASI-40-3B	634-2226-001	Cable, SVO-85() (-001/-003/-101/-103) SVO-3000 (-001/-002/-003)
ASI-40-3C	634-2226-002	Cable, SVO-85() (-002/-004/-102/-104)
ASI-40-3D	634-2226-003	Cable, SVO-3000 (-021/-022/-023/-982/-983)

Equipment Supplied (ASI-403-2):

ASI MN	OEM PN	Description
ASI-40-3E	653-1288-002	Cable, SVO-1000

Optional Equipment:

ASI MN	OEM PN	UUT MANUAL FIGURE	Description
ASI-18-9B	634-2835-001	SVO-75 Fig 902	SMT-65() Capstan Holding Fixture
ASI-18-9C	634-2830-001	SVO-75 Fig 902	SMT-65E Capstan Holding Fixture
ASI-18-9D	NPN	SVO-75 Fig 903 / SVO-3000 Fig 904	Magnetic Clutch Holding Fixture
ASI-18-9E	647-3825-001	SVO-75 Fig 904 / SVO-3000 Fig 903	Backlash Test Fixture (Requires User Supplied 80-144 Dial Ind)
ASI-34-82C	827-1543-001	SVO-3000 Fig 906	Clutch Test Fixture
ASI-40-3F	628-8888-001	SVO-85() Fig 5-34	SVO-85B (-003) Test Cable
ASI-40-31A	NPN	SVO-85() Fig 5-9	SMT-87 Capstan Torque Adjustment Fixture
ASI-40-31B	634-1729-001	SVO-85() Fig 5-10	Servo Clutch Depth Gauge (Requires User Supplied 25-243J and 6632-5)
ASI-40-31B1	NPN	SVO-1000 Fig 905	Servo Clutch Depth Gauge (Requires User Supplied 25-243J and 6632-5)
ASI-40-31C	634-1728-001	SVO-85() Fig 5-11	Mount Clutch Depth Gauge (Requires User Supplied 25-243J and 6632-5)
ASI-40-31C1	NPN	SVO-1000 Fig 906	Mount Clutch Depth Gauge (Requires User Supplied 25-243J and 6632-5)
ASI-40-31D	634-1772-001	SVO-85() Fig 5-12 / SVO-1000 Fig 904	SVO-85/SVO-1000/TSM-1000 Backlash Test Fixture (Req 25-241J)
ASI-40-31D1	634-1772-002	SVO-85() Fig 5-12 / SVO-1000 Fig 904	SVO-85/SVO-1000/TSM-1000 Backlash Test Fixture (Includes 25-241J)
ASI-40-31E	NPN	SVO-85() Fig 5-13	Servo Run-In Fixture
ASI-40-31F	NPN	SVO-85() Fig 5-14 / SVO-1000 Fig 908	SVO-85/SVO-1000 Preload Fixture
ASI-40-31G	NPN	SVO-85() Fig 5-15 / SVO-1000 Fig 909	SMT-85/86/1000 Preload Fixture
ASI-40-31H	NPN	SVO-85() Fig 5-16	SMT-87 Preload Adjustment Screw
ASI-40-31J	827-2298-001	SVO-85() Fig 5-17	Brush Adjust Fixture
ASI-40-31K	NPN	SVO-85() Fig 5-18	Clutch Bearing Installation Tool
ASI-40-31L	NPN	SVO-85() Fig 5-19	Servo Clutch Half Support
ASI-40-31M	NPN	SVO-85() Fig 5-20	Servo Mount Support
ASI-40-31N	NPN	SVO-85() Fig 5-21	Ball Staking Tool
ASI-40-31P	NPN	SVO-85() Fig 5-22	Bearing Removal Tool
ASI-40-31Q	NPN	SVO-85() Fig 5-23	Bushing Support
ASI-40-31R	NPN	SVO-85() Fig 5-24	Bushing Removal Tool
ASI-40-31S	NPN	SVO-85() Fig 5-25	Pin Insertion and Removal punches
ASI-40-31T	NPN	SVO-85() Fig 5-26	SMT-85/86 Drilling Fixture
ASI-40-31U	NPN	SVO-85() Fig 5-27	SMT-85/86 Pinning Fixture
ASI-40-31V	NPN	SVO-85() Fig 5-28	SMT-87 Drilling Fixture
ASI-40-31W	NPN	SVO-85() Fig 5-29	SMT-87 Pinning Fixture
ASI-40-31X	NPN	SVO-85() Fig 5-30	SVO-85 / 86 Drilling Fixture
ASI-40-31Y	NPN	SVO-85() Fig 5-31	SVO-85 Pin Removal / Insertion Fixture
ASI-40-31Z	NPN	SVO-85() Fig 5-32	Cable Tensioning Fixture
ASI-40-32A	827-1090-001	SVO-85() Fig 5-33 / SVO-1000 Fig 903A	Backlash/Torque Test Fixture (Req 25-241J Dial Ind)
ASI-40-32B1	830-5758-001	SVO-1000 Fig 923	Torque Test Fixture (Requires 25-241 Dial Ind)
ASI-40-32B2	830-5758-002	SVO-85() Fig 5-35	SMT Shaft Free Play Fixture (Requires 25-241 Dial Ind)
ASI-40-32C	NPN	SVO-85() Fig 5-36	Gear-Cluster Bearing Removal Fixture
ASI-40-32D	827-2785-001	SVO-85() Fig 5-37 / SVO-1000 Fig 904A	SVO-85C/SVO-1000 Clutch Half Force Test Tool (Req 25-243 Dial Ind)
ASI-40-32E	NPN	SVO-85() Fig 5-38	SMT-87 Seal Installation Tool
ASI-40-32F	NPN	SVO-85() Fig 5-39	Motor End Play Fixture
ASI-40-32G	NPN	SVO-85() Fig 5-40	Gear Movement Tool
ASI-40-32H	NPN	SVO-1000 Fig 907	Servo Clutch Fixture
ASI-40-32J	NPN	SVO-1000 Fig 910	Pressure Check Fitting
ASI-40-32K	NPN	SVO-1000 Fig 911	Gland Retainer
ASI-40-32L	NPN	SVO-1000 Fig 912	Mount Loading Fixture
ASI-40-32M	827-3794-001	SVO-1000 Fig 913	Expander Fixture
ASI-40-32N	827-3793-001	SVO-1000 Fig 914	Pusher Fixture
ASI-40-32P	827-3795-001	SVO-1000 Fig 915	Compressor Fixture
ASI-40-32Q	827-2704-001	SVO-1000 Fig 916	Servo Housing Leak Check Fixture
ASI-40-32R	827-2796-001	SVO-1000 Fig 917	Slip Clutch Check Fixture
ASI-40-32S	NPN	SVO-1000 Fig 922	Servo Mount Pressure Leak Test Assembly
ASI-158-1	637-7656-100	SVO-1000 Fig 919 - 921	Universal High Pot Tester
ASI-212-3	622-2741-001	SVO-75 Fig 902	Torque Tester (960M-3)
ASI-212-4	622-5434-001	SVO-85() Fig 5-1 / SVO-1000 Fig 101	Torque Tester (960M-4)
ASI-212-5	622-6454-001	SVO-75 Fig 902 / SVO-3000 Fig 905	Torque Tester (960M-5)
ASI-246-2	621-9185-002	SVO-75 Fig 902	Capstan Clutch Adjustment Fixture (14 tooth)
ASI-246-3	822-0030-001	SVO-85 Install Manual Table 5-2	Servo Mount Test Adapter (997T-1)
ASI-0319-070	229-0319-070	SVO-85() Table 5-3 / SVO-1000 Fig 901	Flux Keeper (37360-9)
ASI-0319-120	229-0319-120	SVO-1000 Fig 901	Flux Keeper (A-92066)

BCA Servo Test Panel

ASI-404-1

OEM Equivalent: Rockwell Collins
 MN: 676-3923-001
 PN: 676-3923-001
 Manual: 523-0777073 / 22-12-74
 Manual Figure: 911 - 914

UUT: BCA-770
 S253W911-1/-2/-3
 Size: H: 7.00" W: 19.00" D: 7.00"
 Pwr: 115 VAC 60 Hz / 28 VDC

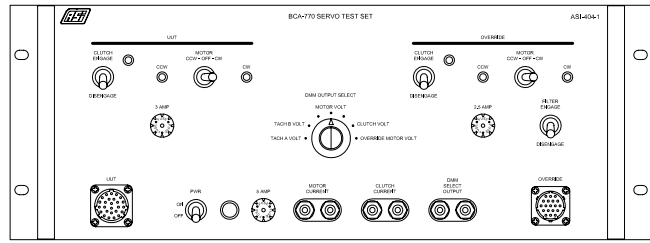

Description:

The ASI-404-1 Servo Test Panel works in conjunction with a Dynamometer (827-7102-003) to facilitate testing of the Collins BCA-770 Backdrive Control Actuator. A known good SVO-85A (user supplied) is also required for testing.

The BAC-770 attaches directly to the front of the Test Set. Cables for the SVO-85A are included with the ASI-404-1. Other accessory items that may be required for testing and repairing the BCA-770 are listed in the optional equipment.

Equipment Supplied:

ASI MN	OEM PN	Description
ASI-40-4A	NPN	Cable, ASI-404-1 to SVO-85A (-001/-101)
ASI-40-4B	NPN	Cable, ASI-404-1 to SVO-85A (-002/-102)

Optional Equipment:

ASI MN	OEM PN	Description
ASI-40-31B	634-1729-001	Clutch Servo Depth Gauge (Requires 25-243)
ASI-40-31C	634-1728-001	Mount Clutch Depth Gauge (Requires 25-243)
ASI-40-32D	827-2785-001	Clutch Force Test Tool (Requires 25-243)
ASI-40-32M1	827-3794-002	Expander Fixture
ASI-40-32N	827-3793-001	Pusher Fixture
ASI-40-32P1	827-3795-002	Compressor Fixture
ASI-40-41A	676-3871-001	Backlash Test Fixture (Requires 25-241)
ASI-40-41B	460-0079-246	Actuator Pressure Leak Test Assembly
ASI-40-41B1	827-1646-001	Pressure Check Fitting (P/O ASI-40-41B)
ASI-40-41B2	827-0332-001	Slip Clutch Leak Fixture (P/O ASI-40-41B)
ASI-40-41C	676-3866-001	Torque Backlash Test Fixture (Req 25-241J)
ASI-40-41D	131-3605-464	Override Slip Clutch Test Fixture
ASI-40-41E	131-3605-422	Mount Assembly Preload Test Fixture
ASI-40-41F	131-3605-423	Mount Assembly Force-Pull Test Fixture
ASI-40-41G	117-0600-107	Mount Assembly Drilling and Pinning Fixture
ASI-40-41H	131-3605-469	Motor Tension Adjuster
ASI-158-1	637-7656-100	Universal Hi-Pot tester
ASI-15-8B	830-2523-001	Cable, ASI-158 to BCA-770

Flight Mode Annunciator Test Panel

ASI-405

OEM Equivalent: Rockwell Collins
 MN: 969L-1
 PN: 635-7420-001
 Manual: 523-0767303
 Manual Figure: 1

UUT: 914G-8 / 914G-9 / 914G-11
 Size: H: 7.00" W: 19.00" D: 7.00"
 Pwr: 115 VAC 400 Hz / 28 VDC

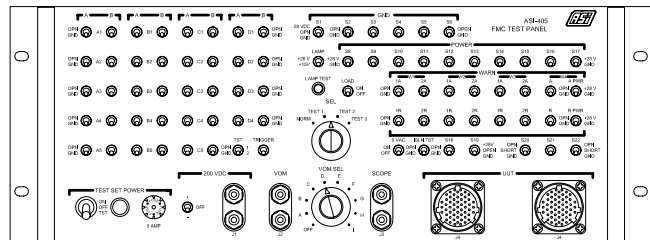

Description:

The ASI-405 Test Set develops and processes input/output signals required for testing the Rockwell Collins 914G-8/-9/-11 Flight Mode Annunciators.

The ASI-405 includes interconnect cables required to test the 914G-8, 914G-9, 914G-11 Flight Mode Annunciators.

Equipment Supplied:

ASI MN	OEM PN	Description
ASI-40-5A	635-7413-001	Cable, Power
ASI-40-5B	635-7414-001	Cable, ASI-405 to 914G-8
ASI-40-5C	635-7415-001	Cable, ASI-405 to 914G-9
ASI-40-5D	634-9488-001	Cable, ASI-405 to 914G-11

Optional Equipment:

ASI MN	OEM PN	Description
--------	--------	-------------

147B-2 Test Panel

ASI-406

OEM Equivalent: Rockwell Collins
 MN:
 PN:
 Manual: 523-0766906
 Manual Figure: 1 (Maintenance Sec)

UUT: 147B-2
 Size: H: 3.50" W: 19.00" D: 6.00"
 Pwr: 26 VAC 400 Hz

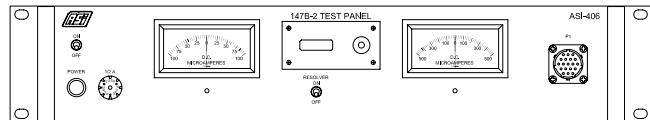

Description:

The ASI-406 Test Panel provides the capability to test and repair the Rockwell Collins 147B-2 Converter-Discriminator.

The ASI-406 includes the test cable required to interconnect the 147B-2 to the test panel.

Equipment Supplied:

ASI MN	OEM PN	Description
ASI-40-6A	NPN	Cable, ASI-406 to 147B-2

Optional Equipment:

ASI MN	OEM PN	Description
--------	--------	-------------

Power Supply and Readout Fixture

ASI-407-1

OEM Equivalent:

OEM: Sperry
 Model Number:
 Part Number: T307702-4
 Manual: 31-3000-01
 Manual Figure: 1-3

This unit is manufactured to replace the OEM MN, PN, and/or manual figure listed in Form, Fit, and Function.

Description:

The ASI-407-1 Power Supply and readout Fixture supplies power and a readout to test the Sperry C-14 () Gyro Synchronizer.

The ASI-407-1 requires a user supplied API (NAI 8500 or equivalent) for proper operation.

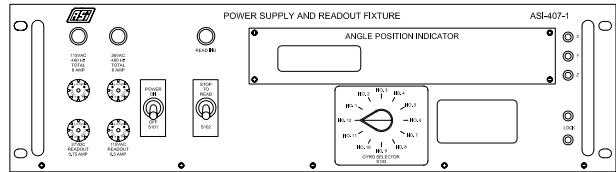

Units Tested:

C-14 DG-401
 C-14A TARSYN
 C-14D TARSYN-H

Specifications:

Height: 5.25" Width: 19.00" Depth: 12.00"
 Power Requirements: 115 VAC 400 Hz

Equipment Supplied:

ASI MN	OEM PN	Description
--------	--------	-------------

Optional Equipment:

ASI MN	OEM PN	Description
ASI-275-1	T307976	C-14 Preliminary and Final Test Fixture
ASI-275-2	T307977	DG-401 Calibration Fixture
ASI-408	T322861	C-14D Base Test Fixture
ASI-409	T322780	C-14 Amplifier/Synchronizer Test Fixture
ASI-410	T307967	Flux Valve Heading Simulator

API Latching Fixture

ASI-407-2

OEM Equivalent:

OEM: Sperry
 Model Number:
 Part Number: T321272-901
 Manual: 31-3000-01
 Manual Figure: 1-8

This unit is manufactured to replace the OEM MN, PN, and/or manual figure listed in Form, Fit, and Function.

Description:

The ASI-407-2 API Latching Fixture provides a method for accurate measurement of Sperry VG-14 Vertical Gyro drift, erection rates, and other critical tests.

The ASI-407-2 requires a user supplied API (NAI 8500 or equivalent) for proper operation.

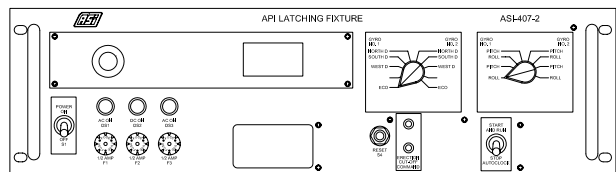

Units Tested:

VG-14 VG-401
 VG-14A TARSYN
 VG-14H TARSYN-H

Specifications:

Height: 5.25" Width: 19.00" Depth: 12.00"
 Power Requirements: 115 VAC 400 Hz

Equipment Supplied:

ASI MN	OEM PN	Description
--------	--------	-------------

Optional Equipment:

ASI MN	OEM PN	Description
ASI-260-1	T321703	TARSYN / VG-14 Final Test Fixture
ASI-260-2	T321705	TARSYN / VG-14 Field Test Fixture
ASI-411-1	T322695	VG-401 Test Fixture
ASI-411-2	T322880	TARSYN-H / VG-14H Base Test Fixture

C-14D Base Test Fixture

ASI-408

OEM Equivalent:

OEM: Sperry
 Model Number:
 Part Number: T322861
 Manual: 31-3000-01
 Manual Figure: 1-17

This unit is manufactured to replace the OEM MN, PN, and/or manual figure listed in Form, Fit, and Function.

Description:

The ASI-408 Base Test Fixture provides the power, loads, signals, and switching required to test the Sperry C-14D Base Assembly.

The ASI-408 includes three test cables required for proper operation.

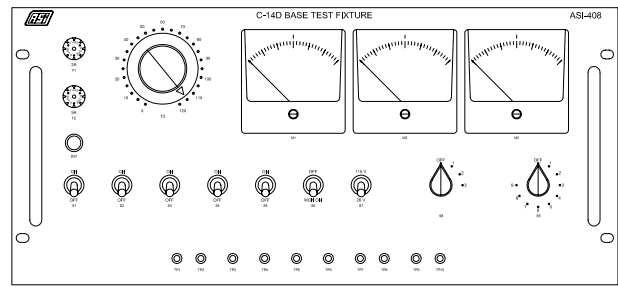

Units Tested:

C-14D

Specifications:

Height: 8.75" Width: 19.00" Depth: 10.00"
 Power Requirements: 115 VAC 400 Hz

Optional Equipment:

ASI MN	OEM PN	Description
ASI-275-1	T307976	C-14 Preliminary and Final Test Fixture

Equipment Supplied:

ASI MN	OEM PN	Description
ASI-40-8A	T322861-4	Cable, W1
ASI-40-8B	T322861-5	Cable, W2
ASI-40-8C	T322861-6	Cable, W3

C-14 Amplifier / Synchronizer Test Fixture

ASI-409

OEM Equivalent:

OEM: Sperry
 Model Number:
 Part Number: T322780
 Manual: 31-3000-01
 Manual Figure: 1-16

This unit is manufactured to replace the OEM MN, PN, and/or manual figure listed in Form, Fit, and Function.

Description:

The ASI-409 Amplifier / Synchronizer Test Fixture provides the power, loads, and signals required to test the directional gyro synchronizer amplifier assembly of the Sperry C-14A/D Directional Gyro.

The ASI-409 includes three test cables required for proper operation.

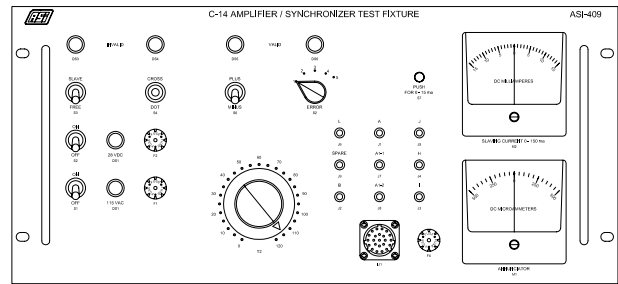

Units Tested:

C-14A C-14D

Specifications:

Height: 8.75" Width: 19.00" Depth: 10.00"
 Power Requirements: 115 VAC 400 Hz / 28 VDC

Optional Equipment:

ASI MN	OEM PN	Description
ASI-275-1	T307976	C-14 Preliminary and Final Test Fixture

Equipment Supplied:

ASI MN	OEM PN	Description
ASI-40-9A	T322780-50	Cable, W1
ASI-40-9B	T322780-51	Cable, W2
ASI-40-9C	T322780-3	Cable, W3

Flux Valve Heading Simulator

ASI-410

OEM Equivalent:

OEM: Sperry
 Model Number:
 Part Number: T307967
 Manual: 31-3000-01
 Manual Figure: 1-4

This unit is manufactured to replace the OEM MN, PN, and/or manual figure listed in Form, Fit, and Function.

Description:

The ASI-410 Flux Valve Heading Simulator provides a method of simulating a flux valve input when calibrating the Sperry C-14A/D Directional Gyro.

The ASI-410 includes two test cables required for proper operation.

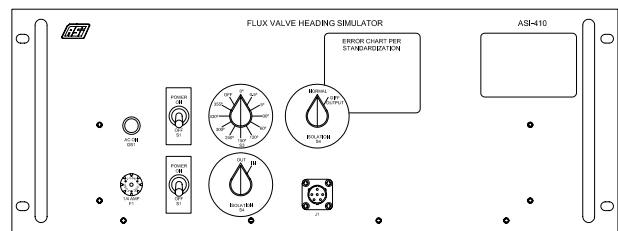

Units Tested:

C-14 C-14A C-14D DG-304

Specifications:

Height: 7.00" Width: 19.00" Depth: 14.00"
 Power Requirements: 115 VAC 400 Hz

Optional Equipment:

ASI MN	OEM PN	Description
ASI-275-1	T307976	C-14 Preliminary and Final Test Fixture

Equipment Supplied:

ASI MN	OEM PN	Description
ASI-41-0A	T307967-40	Cable, W1
ASI-41-0B	T307967-42	Cable, W2

VG-401 Test Fixture

ASI-411-1

OEM Equivalent:

OEM: Sperry
 Model Number:
 Part Number: T322695
 Manual: 31-3000-01
 Manual Figure: 1-13

This unit is manufactured to replace the OEM MN, PN, and/or manual figure listed in Form, Fit, and Function.

Description:

The ASI-411-1 Test Fixture provides the power, loads, and signals required to test and calibrate the Sperry VG-401/401H Attitude Reference. The Test Fixture has the ability to test and run two units simultaneously.

The ASI-411-1 includes two identical test cables required to test and run two VG-401 Attitude References simultaneously.

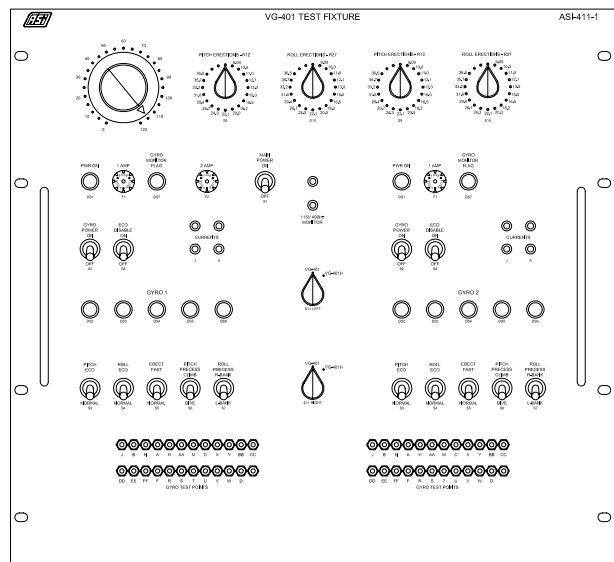

Units Tested:

VG-401 VG-401H

Specifications:

Height: 17.50" Width: 19.00" Depth: 12.00"
 Power Requirements: 115 VAC 400 Hz

Equipment Supplied:

ASI MN	OEM PN	Description
ASI-41-11A	NPN	Cable, W1

Optional Equipment:

ASI MN	OEM PN	Description
ASI-260-1	T321703	TARSYN / VG-14 Final Test Fixture
ASI-260-2	T321705	TARSYN / VG-14 Field Test Fixture
ASI-411-2	T322880	TARSYN-H / VG-14H Base Test Fixture

TARSYN-H / VG-14H Base Test Fixture

ASI-411-2

OEM Equivalent:

OEM: Sperry
 Model Number:
 Part Number: T322880
 Manual: 31-3000-01
 Manual Figure: 1-19

This unit is manufactured to replace the OEM MN, PN, and/or manual figure listed in Form, Fit, and Function.

Description:

The ASI-411-2 Base Test Fixture provides the power, loads, and signals required to test the electronics located in the base of the Sperry TARSYN-H Three-Avis Reference and in the base of the VG-14H Vertical Gyro.

The ASI-411-2 includes the test cable required for proper operation.

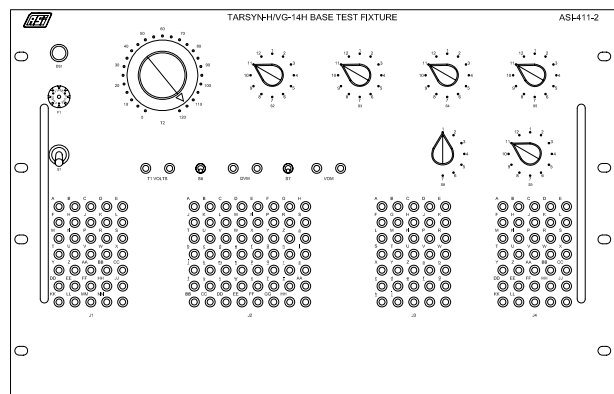

Units Tested:

VG-14H TARSYN-H

Specifications:

Height: 12.25" Width: 19.00" Depth: 12.00"
 Power Requirements: 115 VAC 400 Hz

Equipment Supplied:

ASI MN	OEM PN	Description
ASI-41-12A	NPN	Cable, W1

Optional Equipment:

ASI MN	OEM PN	Description
ASI-260-1	T321703	TARSYN / VG-14 Final Test Fixture
ASI-260-2	T321705	TARSYN / VG-14 Field Test Fixture
ASI-411-1	T322695	VG-401 Test Fixture

MCS-65 Compass System Test Panel

ASI-412

OEM Equivalent: Rockwell Collins MN: CTS-64 PN: 622-6459-001 Manual: 523-0773595 Manual Figure: 1-1	UUT: MCS-65 Magnetic Compass System DGS-65, FDU-70, CCU-65, RCP-65
	Size: H: 10.5" W: 19.00" D: 10.0" Pwr: 115 VAC 400 Hz / 28 VDC

Description:
 The ASI-412 Test Panel is used for minimum and detailed performance testing of the DGC-65 Directional Gyro and system testing of the MCS-65 Magnetic Compass System (DGS-65, FDU-70, CCU-65, RCP-65).

The ASI-412 is also capable of testing the modules of the DGS-65 including the gyro assembly, compass electronics assembly and the power supply card.

The ASI-412 includes ten test cables (ASI-41-2x) and the "Bed of Nails" test fixture

Equipment Supplied:

ASI MN	OEM PN	Description
ASI-41-2A	634-3381-001	Cable, P1
ASI-41-2B	634-3474-001	Cable, P2
ASI-41-2C	628-7452-001	Cable, Emulator (SB2)
ASI-41-2D	634-3476-001	Cable, P4
ASI-41-2E	634-3477-001	Cable, P5
ASI-41-2F	634-3478-001	Cable, P6
ASI-41-2G	634-3480-001	Cable, P7
ASI-41-2H	634-3482-001	Cable, P9
ASI-41-2I	634-1078-001	Cable, P10
ASI-41-2J	634-3483-001	Cable, J1
ASI-412-1	647-6750-001	Test Fixture, Bed of Nails

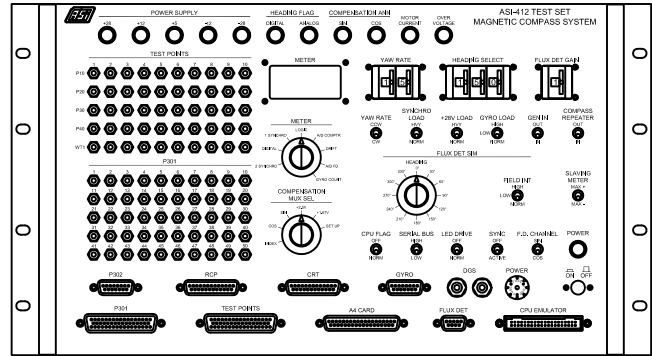

DGS-65 Customer Acceptance Test Set

ASI-412-2

OEM Equivalent: Rockwell Collins MN: NMN PN: NPN Manual: 523-0771840 Manual Figure: 5-13	UUT: DGS-65
	Size: H: 3.00" W: 12.00" D: 4.00" Pwr: 28 VDC

Description:
 The ASI-412-2 Test Set is used in acceptance testing of the DGS-65. The ASI-412-2 checks the functional performance of the DGS-65 but does not check if it is fully operational within specifications. Therefore the ASI-412-2 cannot be used to return a unit to service.

The ASI-412 System Test Panel (shown above) is required for full return-to-service testing of the DGS-65.

The ASI-412-2 includes the three test cables (ASI-41-22x) listed below.

Equipment Supplied:

ASI MN	OEM PN	Description
ASI-41-22A	NPN	Cable, 331A-3G
ASI-41-22B	NPN	Cable, RMI-30
ASI-41-22C	NPN	Cable, HSI-70 / FDU-70

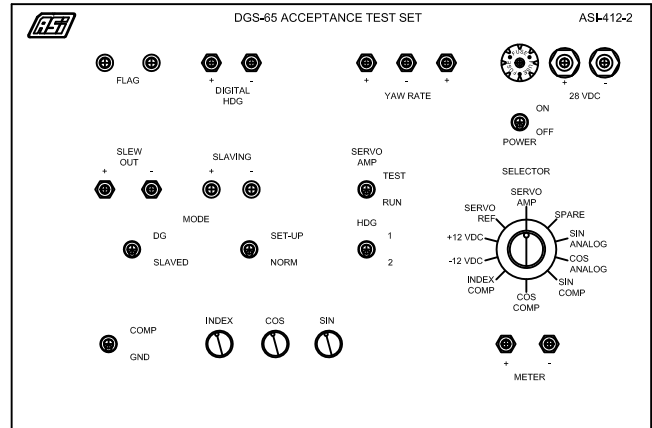

Optional Equipment:

ASI MN	OEM PN	UUT Manual Figure	Description
ASI-41-22D	NPN	DGS-65 Fig. 5-16	DGS-65 Gyro Cover Removal Tool
ASI-41-22E	NPN	DGS-65 Fig. 5-17	DGS-65 End Cap Puller
ASI-41-22F	NPN	DGS-65 Fig. 5-18	DGS-65 Fan Puller
ASI-41-22G	NPN	DGS-65 Fig. 5-19	DGS-65 Balancing Fixture
ASI-41-22H	NPN	DGS-65 Fig. 5-20	DGS-65 Calibrated Motor
ASI-41-22J	NPN	DGS-65 Fig. 5-21	DGS-65 Modified Drill Bit
ASI-41-22K	NPN	DGS-65 Fig. 5-22	DGS-65 Degree Tape
ASI-41-22L	NPN	DGS-65 Fig. 5-23	DGS-65 Motor Run-In Stand
ASI-41-22M	NPN	DGS-65 Fig. 5-24	DGS-65 Preload Fixture
ASI-41-22N	NPN	DGS-65 Fig. 5-25	DGS-65 Modified Cap
ASI-41-22P	NPN	DGS-65 Fig. 5-26	DGS-65 Rundown Fixture
ASI-41-22Q	NPN	DGS-65 Fig. 5-27	DGS-65 Slipping Removal Fixture

ILS Receiver Test Panel

ASI-413-1

OEM Equivalent:

OEM: Bendix
 Model Number: RIT-32A
 Part Number: 2070809-3201
 Manual: I.B. 1132AT / 34-36-01
 Manual Figure: 1

This unit is manufactured to replace the OEM MN, PN, and/or manual figure listed in Form, Fit, and Function.

Description:

The ASI-413-1 ILS Receiver Test Panel facilitates testing, alignment, and troubleshooting of the Bendix RIA-31A ILS Navigation Receiver.

The ASI-413-1 contains all necessary loads and switches required to simulate a single system installation required by the RIA-32A Receiver. In addition, meters and switches are provided to accurately measure all of the output voltages and currents from the RIA-32A instrumentation circuits as well as from the ATE connector.

The ASI-413-1 includes the interconnecting cable (ASI-41-31A) required for testing the RIA-32A.

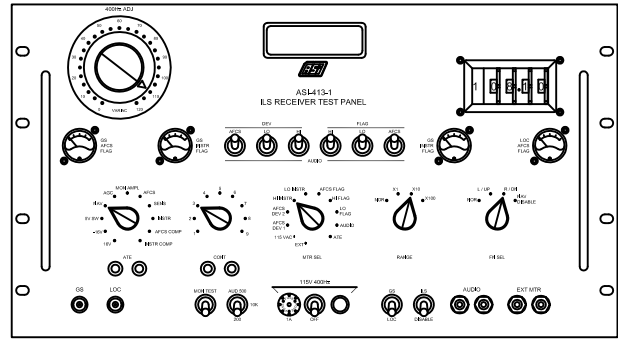

Units Tested:

RIA-32A

Specifications:

Height: 15.00" Width: 19.00" Depth: 10.50"
 Power Requirements: 115 VAC 400 Hz

Equipment Supplied:

ASI MN	OEM PN	Description
ASI-41-3A	2038683-0501	Cable, ASI-413-1 to RIA-32A (W101)

Optional Equipment:

ASI MN	OEM PN	Description
ASI-413-2	2070776-3201	ILS Audio Generator (RIG-32A)

ILS Audio Generator

ASI-413-2

OEM Equivalent:

OEM: Bendix
 Model Number: RIG-32A
 Part Number: 2070776-3201
 Manual: I.B. 1132AT / 34-36-02
 Manual Figure: 1

This unit is manufactured to replace the OEM MN, PN, and/or manual figure listed in Form, Fit, and Function.

Description:

The ASI-413-2 ILS Generator functions as a primary modulation standard to test and calibrate airborne ILS receivers including the Bendix RIA-32A and RNA-34A.

The ASI-413-2 provides the stable, precision 90 and 150 Hz tone signals required to modulate RF signal generators used for testing and alignment of airborne ILS receivers. The design of the unit allows flexibility for interfacing with existing RF signal generators. The 90 and 150 Hz localizer and glide slope modulation signals, generated by the ASI-413-2, have a high degree of frequency and amplitude stability, which is maintained by an automatic calibration loop. Front panel switching is provided for selection of various differences in the depth of modulation (DDM) test signals for both localizer and glide slope functions.

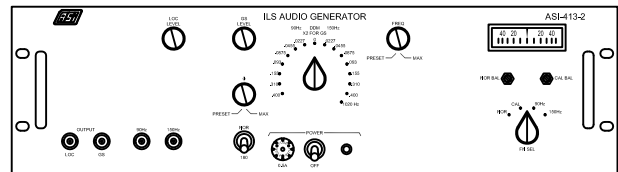

Units Tested:

RIA-32A
 RNA-34A

Specifications:

Height: 5.25" Width: 19.00" Depth: 12.00"
 Power Requirements: 115 VAC 400 Hz

Equipment Supplied:

ASI MN	OEM PN	Description
--------	--------	-------------

Optional Equipment:

ASI MN	OEM PN	Description
ASI-177-1	2064139-0501	VHF Receiver Test Panel (RNT-26A)
ASI-413-1	2070809-3201	ILS Receiver Test Panel (RIT-32A)
ASI-420-1	2041341-3401	VHF Receiver Test Panel (RNT-34A)

ADS Air Data Test Panel

ASI-415-1

OEM Equivalent: Collins
 MN: 970D-1A
 PN: 622-5811-001
 Manual: 523-0771559
 Manual Figure: 4-1

UUT: ADS-80/-81/-82 Air Data System
 ADC-80() / -81A/-82A / ALI-80()
 MSI-80() / PRE-80() / VSI-80()
 Size: H: 17.50" W: 19.00" D: 19.00"
 Pwr: 28 VDC / 115 VAC 60Hz

Description:
 The ASI-415-1 Air Data Test Panel is a word generator/receiver and power/timing source used to verify proper operation of the Collins ADS-80/81/82 Air Data System units individually or together as a system.

Seven pendant cable assemblies and a 3-wire diagnostic probe assembly provide an interface with the individual units. signal switching and monitoring is controlled by the ASI-415-1 front panel and the video terminal/keyboard which is included with the test panel. The ASI-415-1 can transmit and receive Manchester, ARINC and pulse density words to verify proper unit operation.

The ASI-415-1 is supplied with a video terminal and an extender assembly kit (ASI-2227-001). The ASI-2227-001 (638-2227-001) includes the six extenders required to access the internal circuit cards of the various ADS-80/81/82 units.

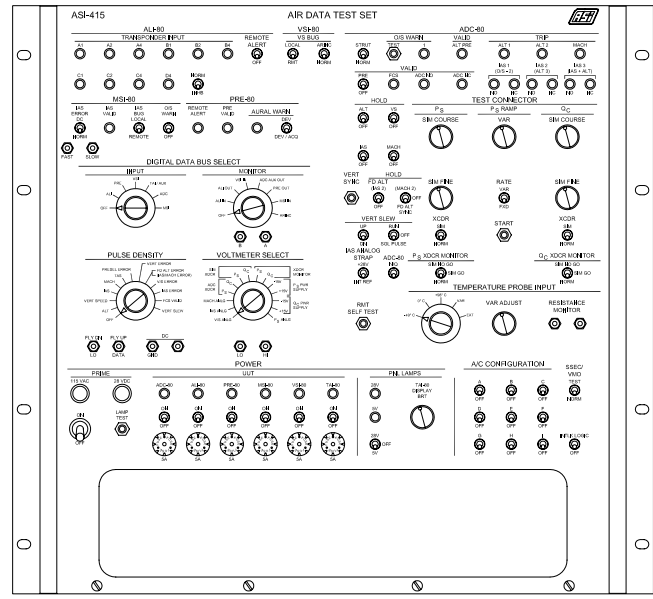

Equipment Supplied:

ASI MN	OEM PN	Description
WY-185ES	VT-320	Video Terminal / Keyboard
ASI-2227-001	638-2227-001	Extender Kit (Includes Six Extenders)*
ASI-2221-001*	638-2221-001	Extender No. 1, ADC-80/81A/82A
ASI-2222-001*	638-2222-001	Extender No. 2, ADC-80/81A/82A
ASI-2223-001*	638-2223-001	Extender No. 3, PRE-80
ASI-2224-001*	638-2224-001	Extender No. 4, ALI-80/MSI-80/VSI-80
ASI-2225-001*	638-2225-001	Extender No. 5, ALI-80/MSI-80/VSI-80
ASI-2226-001*	638-2226-001	Extender No. 6, ALI-80/MSI-80/VSI-80

Optional Equipment:

ASI MN	OEM PN	Description
ASI-41-5A	NPN	Power Supply Load Fixture, ADC
ASI-41-5B	NPN	Pointer Alignment Fixture, ALI/MSI/VLI

ADS Air Data Test Panel

ASI-415-2

OEM Equivalent: Collins
 MN: 970D-1A
 PN: 622-5811-002
 Manual: 523-0771559
 Manual Figure: 4-1

UUT: ADS-80/-81/-82 Air Data System
 ADC-80() / -81A/-82A / ALI-80()
 MSI-80() / PRE-80() / VSI-80()
 Size: H: 17.50" W: 19.00" D: 19.00"
 Pwr: 28 VDC / 115 VAC 60Hz

Description:
 The ASI-415-2 Test Panel is identical to the ASI-415-1 except that it is not supplied with the extender kit (ASI-2227-001).

Equipment Supplied:

ASI MN	OEM PN	Description
WY-185ES	VT-320	Video Terminal / Keyboard

Optional Equipment:

ASI MN	OEM PN	Description
ASI-41-5A	NPN	Power Supply Load Fixture, ADC
ASI-41-5B	NPN	Pointer Alignment Fixture, ALI/MSI/VLI
ASI-2227-001	638-2227-001	Extender Kit (Includes Six Extenders)*
ASI-2221-001*	638-2221-001	Extender No. 1, ADC-80/81A/82A
ASI-2222-001*	638-2222-001	Extender No. 2, ADC-80/81A/82A
ASI-2223-001*	638-2223-001	Extender No. 3, PRE-80
ASI-2224-001*	638-2224-001	Extender No. 4, ALI-80/MSI-80/VSI-80
ASI-2225-001*	638-2225-001	Extender No. 5, ALI-80/MSI-80/VSI-80
ASI-2226-001*	638-2226-001	Extender No. 6, ALI-80/MSI-80/VSI-80

DME Test Set

ASI-416

OEM Equivalent: Collins
 MN: NMN
 PN: NPN
 Manual: 523-0770174 / 523-0770177
 Manual Figure: 25 / 5-6

UUT: DME-40 / 339F-12
 IND-40/-40A/-40B/-40C
 IND-41/-41A/-41B/-41C
 Size: H: 12.25" W: 19.00" D: 8.00"
 Pwr: 28 VDC / 115 VAC 400Hz

Description:
 The ASI-416 DME Test Set works in conjunction with Squawk Naut, ATC-1200Y3, or ATC-1400 to test the Collins DME-40, DME Indicator (339F-12, IND-40/-41), and a VHF Control as a system.

The test set includes five pendant cables for interconnection of the DME-40, Indicator, VHF Control (313N-4D), and associated DME test equipment. The VHF Control is not required if the ATC-1400 is used to channel the DME-40.

The ASI-416 comes wired for the ATC-1400. Interconnection to a Squawk/Naut I/II requires the optional ASI-41-6A Adapter Cable.

See the Optional Equipment list for alternate test equipment available from ASI for testing the DME-40.

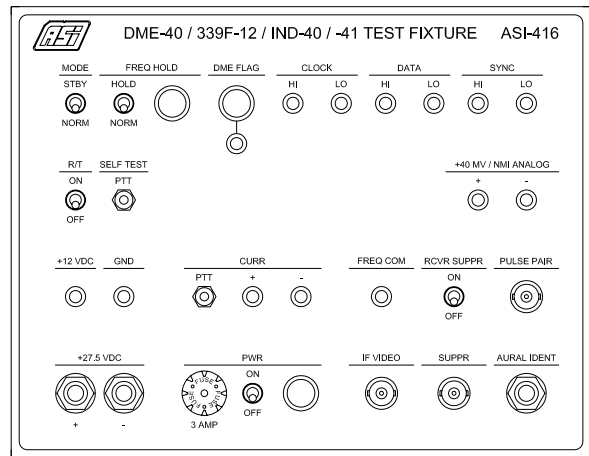

Equipment Supplied:

ASI MN	OEM PN	Description
--------	--------	-------------

Optional Equipment:

ASI MN	OEM PN	Description
ASI-41-6A	NPN	Adapter Cable, ASI-416 to Squawk/Naut I/II
ASI-182	622-3582-001	DME Test Panel (975D-2)
ASI-200-5	NPN	DME Plug-In Adapter for ASI-2000
ASI-283	NPN	DME-40 Troubleshooting Probe
ASI-292	622-4725-001	DME-40 Test Panel (968W-1)

ADS Air Data Test Panel

ASI-415-1

OEM Equivalent: Rockwell Collins
 MN: 970D-1A
 PN: 622-5811-001
 Manual: 523-0771559
 Manual Figure: 4-1

UUT: ADS-80/-81/-82 Air Data System
 ADC-80() / -81A/-82A / ALI-80()
 MSI-80() / PRE-80() / VSI-80()
 Size: H: 17.50" W: 19.00" D: 19.00"
 Pwr: 28 VDC / 115 VAC 60Hz

Description:
 The ASI-415-1 Air Data Test Panel is a word generator/receiver and power/timing source used to verify proper operation of the Collins ADS-80/81/82 Air Data System units individually or together as a system.

Seven pendant cable assemblies and a 3-wire diagnostic probe assembly provide an interface with the individual units. signal switching and monitoring is controlled by the ASI-415-1 front panel and the video terminal/keyboard which is included with the test panel. The ASI-415-1 can transmit and receive Manchester, ARINC and pulse density words to verify proper unit operation.

The ASI-415-1 is supplied with a video terminal and an extender assembly kit (ASI-2227-001). The ASI-2227-001 (638-2227-001) includes the six extenders required to access the internal circuit cards of the various ADS-80/81/82 units.

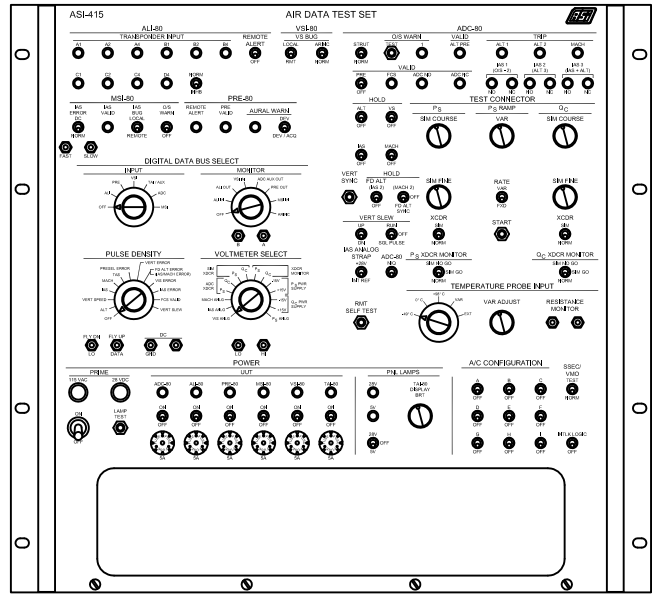

Optional Equipment:

ASI MN	OEM PN	Description
ASI-41-5A	NPN	Power Supply Load Fixture, ADC
ASI-41-5B	NPN	Pointer Alignment Fixture, ALI/MSI/VLI

Equipment Supplied:

ASI MN	OEM PN	Description
WY-185ES	VT-320	Video Terminal / Keyboard
ASI-2227-001	638-2227-001	Extender Kit (Includes Six Extenders)*
ASI-2221-001*	638-2221-001	Extender No. 1, ADC-80/81A/82A
ASI-2222-001*	638-2222-001	Extender No. 2, ADC-80/81A/82A
ASI-2223-001*	638-2223-001	Extender No. 3, PRE-80
ASI-2224-001*	638-2224-001	Extender No. 4, ALI-80/MSI-80/VSI-80
ASI-2225-001*	638-2225-001	Extender No. 5, ALI-80/MSI-80/VSI-80
ASI-2226-001*	638-2226-001	Extender No. 6, ALI-80/MSI-80/VSI-80

ADS Air Data Test Panel

ASI-415-2

OEM Equivalent: Rockwell Collins
 MN: 970D-1A
 PN: 622-5811-002
 Manual: 523-0771559
 Manual Figure: 4-1

UUT: ADS-80/-81/-82 Air Data System
 ADC-80() / -81A/-82A / ALI-80()
 MSI-80() / PRE-80() / VSI-80()
 Size: H: 17.50" W: 19.00" D: 19.00"
 Pwr: 28 VDC / 115 VAC 60Hz

Description:
 The ASI-415-2 Test Panel is identical to the ASI-415-1 except that it is not supplied with the extender kit (ASI-2227-001).

Equipment Supplied:

ASI MN	OEM PN	Description
WY-185ES	VT-320	Video Terminal / Keyboard

Optional Equipment:

ASI MN	OEM PN	Description
ASI-41-5A	NPN	Power Supply Load Fixture, ADC
ASI-41-5B	NPN	Pointer Alignment Fixture, ALI/MSI/VLI
ASI-2227-001	638-2227-001	Extender Kit (Includes Six Extenders)*
ASI-2221-001*	638-2221-001	Extender No. 1, ADC-80/81A/82A
ASI-2222-001*	638-2222-001	Extender No. 2, ADC-80/81A/82A
ASI-2223-001*	638-2223-001	Extender No. 3, PRE-80
ASI-2224-001*	638-2224-001	Extender No. 4, ALI-80/MSI-80/VSI-80
ASI-2225-001*	638-2225-001	Extender No. 5, ALI-80/MSI-80/VSI-80
ASI-2226-001*	638-2226-001	Extender No. 6, ALI-80/MSI-80/VSI-80

DME Test Set

ASI-416

OEM Equivalent: Rockwell Collins
 MN: NMN
 PN: NPN
 Manual: 523-0770174 / 523-0770177
 Manual Figure: 25 / 5-6

UUT: DME-40 / 339F-12
 IND-40/-40A/-40B/-40C
 IND-41/-41A/-41B/-41C
 Size: H: 12.25" W: 19.00" D: 8.00"
 Pwr: 28 VDC / 115 VAC 400Hz

Description:
 The ASI-416 DME Test Set works in conjunction with Squawk Naut, ATC-1200Y3, or ATC-1400 to test the Collins DME-40, DME Indicator (339F-12, IND-40/-41), and a VHF Control as a system.

The test set includes five pendant cables for interconnection of the DME-40, Indicator, VHF Control (313N-4D), and associated DME test equipment. The VHF Control is not required if the ATC-1400 is used to channel the DME-40.

The ASI-416 comes wired for the ATC-1400. Interconnection to a Squawk/Naut I/II requires the optional ASI-41-6A Adapter Cable.

See the Optional Equipment list for alternate test equipment available from ASI for testing the DME-40.

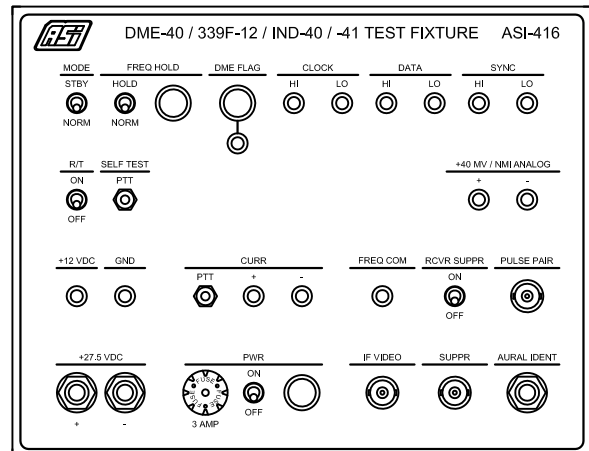

Optional Equipment:

ASI MN	OEM PN	Description
ASI-41-6A	NPN	Adapter Cable, ASI-416 to Squawk/Naut I/II
ASI-182	622-3582-001	DME Test Panel (975D-2)
ASI-200-5	NPN	DME Plug-In Adapter for ASI-2000
ASI-283	NPN	DME-40 Troubleshooting Probe
ASI-292	622-4725-001	DME-40 Test Panel (968W-1)

Equipment Supplied:

ASI MN	OEM PN	Description
--------	--------	-------------

VHF Transceiver Test Panel

ASI-425

OEM Equivalent:

OEM: Bendix
 Model Number: RTT-41A
 Part Number: 2037676-0501
 Manual: I.B.1141T
 Manual Figure: 2

This unit is manufactured to replace the OEM MN, PN, and/or manual figure listed in Form, Fit, and Function.

Description:

The ASI-425 VHF Transceiver Test Panel facilitates bench testing, alignment, and troubleshooting of Bendix/King VHF Transceivers including RTA-41A, RTA-42A, RTA-43A, RTA-83A, KTR-9100, and KTR-9100A. The ASI-425 includes all current modification which include service bulletins 1 through 7.

The ASI-425 contains all power supplies, metering, switching, audio output, and test points required to fully function test the VHF Transceiver.

The ASI-425 includes two interconnect cables required to interface the unit under test and a watt meter to the test set.

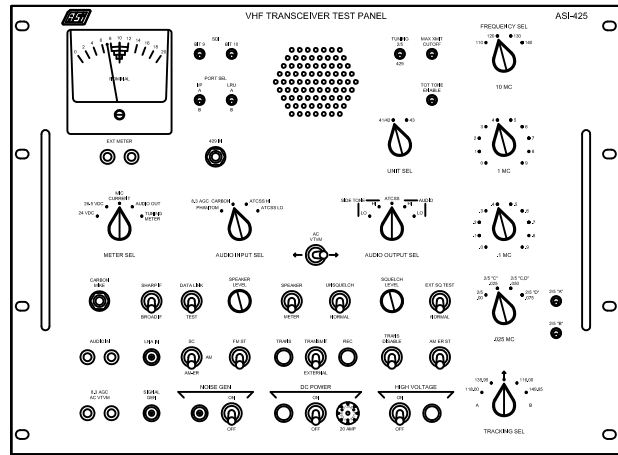

Units Tested:

RTA-41A	RTA-43A	KTR-9100
RTA-42A	RTA-83A	KTR-9100A

Specifications:

Height: 14.00" Width: 19.00" Depth: 14.00"
 Power Requirements: 28 VDC

Equipment Supplied:

ASI MN	OEM PN	Description
ASI-42-5A	NPN	Cable, RT (W101)
ASI-42-5B	NPN	Cable, RF (W103)

Optional Equipment:

ASI MN	Manual Figure Ref	Description
ASI-42-5C	RTA-43A Fig. 1002	Series Detector Circuit
ASI-42-5D	RTA-43A Fig. 1003	Shunt Detector Probe
ASI-42-5E	RTA-43A Fig. 1004	Receiver Cable Assy
ASI-42-5F	RTA-43A Fig. 1005	RF Cable
ASI-42-5G	RTA-43A Fig. 1006	Transmitter Cable Assy
ASI-42-5H	RTA-42A Fig. 1005	Counter/Translator Test Set
ASI-42-5J	RTA-43A Fig. 1006	Mixer

RDR-1500 Radar System Test Panel

ASI-426

OEM Equivalent:

OEM: Bendix
 Model Number: RCT-1500A
 Part Number: 3614129-1501
 Manual: I.B.21500BT
 Manual Figure: 1-0

This unit is manufactured to replace the OEM MN, PN, and/or manual figure listed in Form, Fit, and Function.

Description:

The ASI-426 Radar System Test Panel facilitates testing of the Bendix RDR-1500 and RDR-1500B Radar Systems. The ASI-426 simulates the aircraft vertical reference source, NAV system, DME, and other avionics to enable complete testing of all radar system functions. The Test Panel will also simulate a radar system receiver-transmitter (RT) unit and/or an antenna drive unit to allow testing of the interface unit, control unit and radar indicator.

The ASI-426 may be used to test the complete RDR-1500/1500B Radar System or to determine the operational status of any unit of the system. The Test Panel is comparable to the complete aircraft wiring harness. In conjunction with standard shop test equipment, it allows one unit at a time to be tested or aligned by using known serviceable "black boxes" elsewhere in the test setup. The user supplied CN-1506A mounts directly into the ASI-426 faceplate.

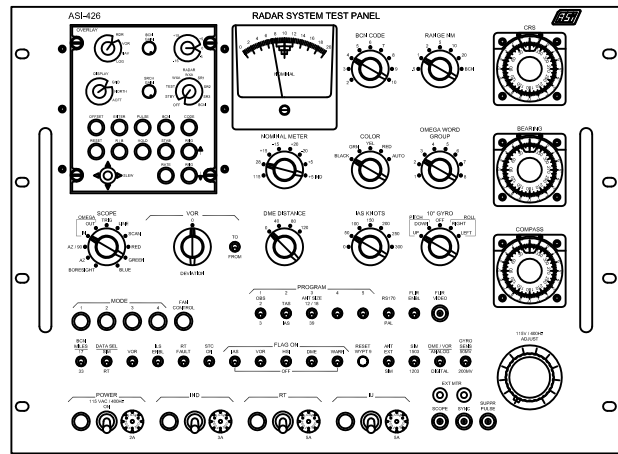

Units Tested:

RT-1501A	DA-1502A	CN-1506A
IN-1502A	DA-1503A	CC-2024()
IN-1502B	IU-1507A	MT-1508A

Specifications:

Height: 14.00" Width: 19.00" Depth: 14.00"
 Power Requirements: 28 VDC and 115 VAC 400 Hz

Equipment Supplied:

ASI MN	OEM PN	Description
ASI-42-6A	8072585-0501	Cable: DA-1503A (W1)
ASI-42-6B	8072586-0501	Cable: DC Power (W2)
ASI-42-6C	8072587-0501	Cable: IU-1507A (W3)
ASI-42-6D	8072588-0501	Cable: MT-1508A (W4)
ASI-42-6E	8072589-0501	Cable: DA-1203A (W5)
ASI-42-6F	8072590-0501	Cable: CC-2024 (W6)
ASI-42-6G	8072591-0501	Cable: IN-1502A (W7)
ASI-42-6H	2040020-0501	Cable: AC Power (W8)
ASI-42-6J	8072594-0501	Cable: RT-1501A (W9)
ASI-42-6K	8072622-0501	Cable: IN-1502B (W10)

Optional Equipment:

ASI MN	OEM PN	Description
ASI-42-6L	NPN	IN-1502A LVPS Load
ASI-42-6M	NPN	Mumetal Shield
ASI-488	TS-488A/UP	Echo box (Modified)
ASI-1207A	4000595-0701	Radar Test Set (TS-1207A)

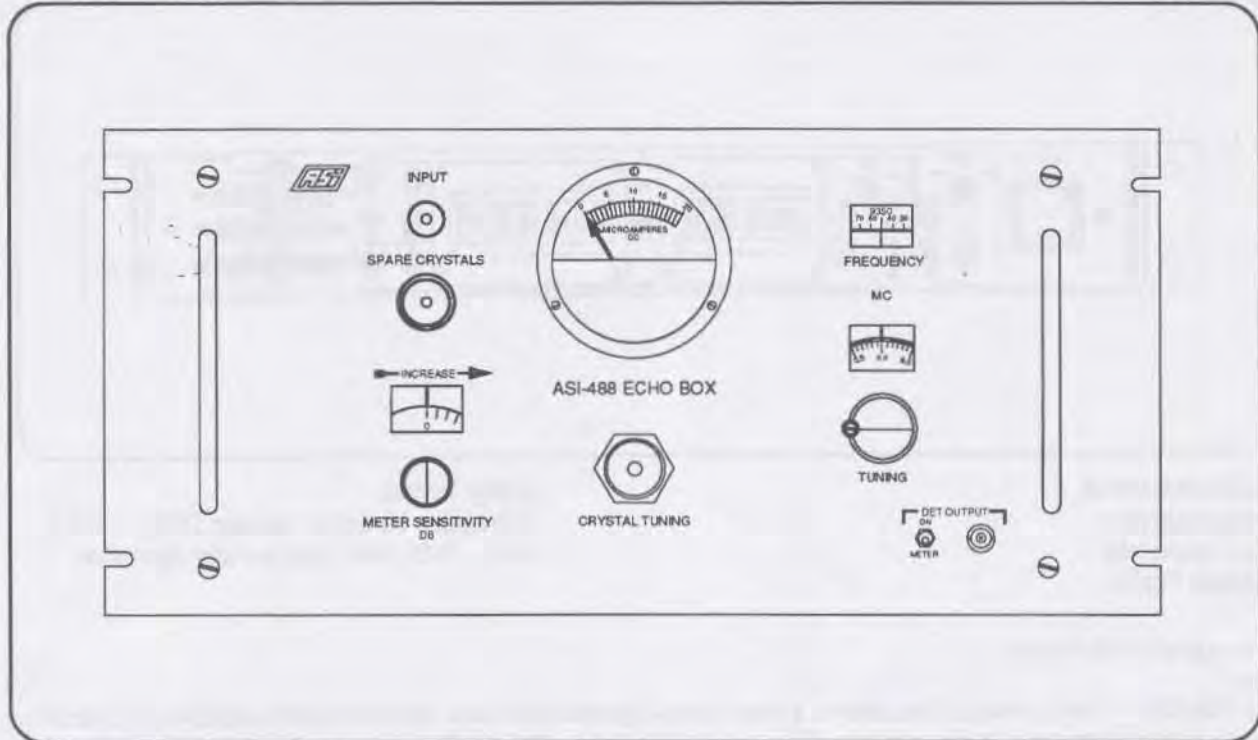

This unit is manufactured to replace the OEM model and/or part number listed below in form, fit, and function.

Equivalent OEM: Military Specification
 Equivalent MN: TS-488A/UP
 Equivalent PN: 279-0176-010
 Manual Figure: WRT-701X (622-5132) Man. Fig. 905

Units Tested:
 Collins WRT-701X
 X-Band Radar Systems

Description of Operation:

The ASI-488 is a remanufactured TS-488A/UP Echo Box that has been adapted to fit into a standard 19" rack. The Echo Box is used to check for proper operation of X-Band radar equipment operating in the frequency range of 8990 to 9610 MHz. The ASI-488 is used to make radar equipment checks such as: measurement of transmitter average power output, transmitter frequency spectrum, radar transmitter for multiple moding and frequency pulling, and T-R box and receiver speed of recovery.

The ASI-488 has also been modified to include a detector output which can be switched so that the detected rf output may be viewed on an oscilloscope, spectrum analyzer or the test panel meter .

Two optional cables are offered for use with the ASI-488:

- ASI-48-8A Standard RF cable (meets minimum specifications).
- ASI-6042 Special high quality, low-loss, highly flexible RF cable (recommended for peak performance).

Specifications:

Height: 8.75" Width: 19.00" Depth: 6.75" Power: N/A

Equipment Supplied:

ASI MN	Equivalent PN	Description
--------	---------------	-------------

Optional Equipment:

ASI MN	Equivalent PN	Description
ASI-48-8A	PE-3062-72	Standard RF Cable
ASI-6042	11556	Special Low-Loss RF Cable

REV 2
3/6/98

KRA-405B Test Set

ASI-495

OEM: Honeywell / Bendix / King MN: MNM PN: 050-03485-0000 Manual: 006-15536-0006 Fig: 9001	UUT: KRA-405B / KNI-415 / KNI-416 Size: H: 3.50" W: 8.00" D: 6.50" Pwr: 28 VDC
---	--

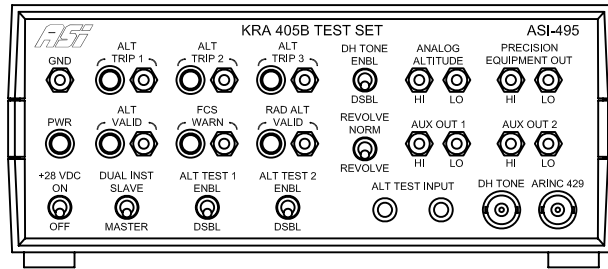

Description:
The ASI-495 Test Set allows testing of the KRA-405B Radio Altimeter and the KNI-415 / KNI-416 Indicators. The ASI-495 Test Set includes five interconnect cables (ASI-49-5x) that are required for testing. The user supplied CM2000 Configuration Module (050-03380-0000) and KRA-405B Test Software (222-00421-0000) must be purchased directly from the OEM (Honeywell).

Equipment Supplied:

ASI MN	OEM PN	Description
ASI-49-5A	NPN	Cable, ASI-495 to KRA-405B
ASI-49-5B	NPN	Cable, ASI-495 to KNI-415 / KNI-416
ASI-49-5C	NPN	Cable, KRA-405B to Computer (PC)
ASI-49-5D1	NPN	RF Cable, Transmit / TNC-N / RG-393 / 186"
ASI-49-5D2	NPN	RF Cable, Receive / TNC-N / RG-393 / 186"

Optional Equipment:

ASI MN	OEM PN	Description
ASI-835000	8350000	Delay Line, 500 nS / 4.2-4.4 GHz

Harmonic Filter

ASI-497-1

OEM Equivalent: Rockwell Collins MN: 967M-1 PN: 622-5285-001 Manual: 523-0772085 Figure: 1	UUT: 548S-3/-3A/-5/-5A/-6 Size: H: 1.00" W: 1.00" D: 3.00" Pwr: From UUT
---	--

Description:
The ASI-497-1 Harmonic Filter is a low-pass (30 MHz cutoff) filter is used for testing the discriminator of the 548S-3/-3A/-5/-5A/-6 Power Amplifier Coupler.

Equipment Supplied:

ASI MN	OEM PN	Description
ASI-207-1	622-0180-001	Dummy Load (172H-18)
ASI-328-3	522-4254-001	Discriminator Tester (878L-17)
ASI-329-7	622-1380-001	Antenna Simulator (172H-21)
ASI-329-11	622-1381-001	Shunt Dummy Antenna (172H-22)

Dual Servo Amplifier Test Set

ASI-497-2

OEM Equivalent: Rockwell Collins MN: 967M-2 PN: 622-5286-001 Manual: 523-0772086 Figure: 1	UUT: 548S-3/-3A/-5/-5A/-6 Size: H: 5.00" W: 7.00" D: 3.00" Pwr: +12 VDC / -12 VDC / +25 VDC
---	---

Description:
The ASI-497-2 Dual Amplifier Test Set is used to mount and test the dual servo amplifier of the 548S-3/-3A/-5/-5A/-6 Power Amplifier Coupler.

Equipment Supplied:

ASI MN	OEM PN	Description
ASI-207-1	622-0180-001	Dummy Load (172H-18)
ASI-328-3	522-4254-001	Discriminator Tester (878L-17)
ASI-329-7	622-1380-001	Antenna Simulator (172H-21)
ASI-329-11	622-1381-001	Shunt Dummy Antenna (172H-22)

Power Amplifier Test Set

ASI-497-3

OEM Equivalent: Rockwell Collins MN: 967M-3 PN: 622-5287-001 Manual: 523-0772087 Figure: 1	UUT: 548S-3/-3A/-5/-5A/-6 Size: H: 8.00" W: 25.00" D: 12.00" Pwr: 115 VAC 60 Hz / +/-12 VDC / +25 VDC
---	---

Description:
The ASI-497-3 Power Amplifier Test Set is used to mount and test the power amplifier of the 548S-3/-3A/-5/-5A/-6 Power Amplifier Coupler.

Equipment Supplied:

ASI MN	OEM PN	Description
ASI-49-73A	647-7870-001	Extender Cable, W1
ASI-49-73B	647-7869-001	Extender Cable, W2
ASI-49-73C	426-1034-010	Power Cable, W3 (17250)
ASI-49-73D	647-7874-001	Extender Cable, W4
ASI-49-73E	651-2978-001	Heatsink

Optional Equipment:

ASI MN	OEM PN	Description
ASI-207-1	622-0180-001	Dummy Load (172H-18)
ASI-328-3	522-4254-001	Discriminator Tester (878L-17)
ASI-329-7	622-1380-001	Antenna Simulator (172H-21)
ASI-329-11	622-1381-001	Shunt Dummy Antenna (172H-22)

Control Circuit Card Test Set

ASI-497-4

OEM Equivalent: Rockwell Collins MN: 967M-4 PN: 622-5288-001 Manual: 523-0772088 Figure: 1	UUT: 548S-3/-3A/-5/-5A/-6 Size: H: 3.00" W: 12.00" D: 8.00" Pwr: +12 VDC / -12 VDC
---	--

Description:
The ASI-497-4 Control Circuit Card Test Set is used to mount and test the control circuit card of the 548S-3/-3A/-5/-5A/-6 Power Amplifier Coupler.

Equipment Supplied:

ASI MN	OEM PN	Description
ASI-207-1	622-0180-001	Dummy Load (172H-18)
ASI-328-3	522-4254-001	Discriminator Tester (878L-17)
ASI-329-7	622-1380-001	Antenna Simulator (172H-21)
ASI-329-11	622-1381-001	Shunt Dummy Antenna (172H-22)

Preregulator Test Set

ASI-497-5

OEM Equivalent: Rockwell Collins MN: 967M-5 PN: 622-5289-001 Manual: 523-0772089 Figure: 1	UUT: 548S-3/-3A/-5/-5A/-6 Size: H: 3.00" W: 12.00" D: 8.00" Pwr: +25 VDC / +28 VDC
---	--

Description:
The ASI-497-5 Preregulator Test Set is used to mount and test the preregulator of the 548S-3/-3A/-5/-5A/-6 Power Amplifier Coupler.

Equipment Supplied:

ASI MN	OEM PN	Description
ASI-207-1	622-0180-001	Dummy Load (172H-18)
ASI-328-3	522-4254-001	Discriminator Tester (878L-17)
ASI-329-7	622-1380-001	Antenna Simulator (172H-21)
ASI-329-11	622-1381-001	Shunt Dummy Antenna (172H-22)

Horizontal Situation Indicator Test Set		ASI-499-1																		
OEM Equivalent: Rockwell Collins MN: 476E-4 PN: 522-1487-004 Manual: TO 33A1-3-147-31 Fig: 1-1	UUT: AF/A24J-1 Size: H: 16.0" W: 9.25" D: 14.12" Pwr: 115 VAC 400 Hz	Equipment Supplied: <table border="1"> <thead> <tr> <th>ASI MN</th> <th>OEM PN</th> <th>Description</th> </tr> </thead> <tbody> <tr> <td>ASI-49-94A</td> <td>545-4559-003</td> <td>Cable 1: ASI-499-1/2/4 to External Power</td> </tr> <tr> <td>ASI-49-94B</td> <td>545-4604-004</td> <td>Cable 2: ASI-499-1/2/4 to HSI Amplifier</td> </tr> <tr> <td>ASI-49-94C</td> <td>545-4605-004</td> <td>Cable 3: ASI-499-1/2/4 to Aircraft Inst Wiring</td> </tr> <tr> <td>ASI-49-94D</td> <td>545-4607-004</td> <td>Cable 4: ASI-499-1/2/4 to HSI 1J2</td> </tr> <tr> <td>ASI-49-94E</td> <td>545-4609-004</td> <td>Cable 5: ASI-499-1/2/4 to HSI 1J1</td> </tr> </tbody> </table>	ASI MN	OEM PN	Description	ASI-49-94A	545-4559-003	Cable 1: ASI-499-1/2/4 to External Power	ASI-49-94B	545-4604-004	Cable 2: ASI-499-1/2/4 to HSI Amplifier	ASI-49-94C	545-4605-004	Cable 3: ASI-499-1/2/4 to Aircraft Inst Wiring	ASI-49-94D	545-4607-004	Cable 4: ASI-499-1/2/4 to HSI 1J2	ASI-49-94E	545-4609-004	Cable 5: ASI-499-1/2/4 to HSI 1J1
ASI MN	OEM PN	Description																		
ASI-49-94A	545-4559-003	Cable 1: ASI-499-1/2/4 to External Power																		
ASI-49-94B	545-4604-004	Cable 2: ASI-499-1/2/4 to HSI Amplifier																		
ASI-49-94C	545-4605-004	Cable 3: ASI-499-1/2/4 to Aircraft Inst Wiring																		
ASI-49-94D	545-4607-004	Cable 4: ASI-499-1/2/4 to HSI 1J2																		
ASI-49-94E	545-4609-004	Cable 5: ASI-499-1/2/4 to HSI 1J1																		
<p>Description:</p> <p>The ASI-499-1 Test Set provides facilities for testing the AF/A24J-1 Horizontal Situation Indicator Group. The Test Set supplies test signals to the indicator and determines if the indicator is responding properly.</p> <p>The ASI-499-1 includes the cables required to interconnect to the indicator and the aircraft during testing.</p> <p>The ASI-499-4 (476E-4C) is the suggested replacement for the ASI-499-1 (476E-4).</p>		Optional Equipment: <table border="1"> <thead> <tr> <th>ASI MN</th> <th>OEM PN</th> <th>Description</th> </tr> </thead> <tbody> <tr> <td>ASI-499-4</td> <td>522-3547-000</td> <td>Horizontal Situation Indicator Test Set</td> </tr> </tbody> </table>	ASI MN	OEM PN	Description	ASI-499-4	522-3547-000	Horizontal Situation Indicator Test Set												
ASI MN	OEM PN	Description																		
ASI-499-4	522-3547-000	Horizontal Situation Indicator Test Set																		

Horizontal Situation Indicator Test Set		ASI-499-2																								
OEM Equivalent: Rockwell Collins MN: 476E-4A PN: 522-2698-004 Manual: TO 33A1-3-147-31 Fig: 1-1	UUT: AF/A24J-1 / AQU-2/A Size: H: 16.0" W: 9.25" D: 14.12" Pwr: 115 VAC 400 Hz	Equipment Supplied: <table border="1"> <thead> <tr> <th>ASI MN</th> <th>OEM PN</th> <th>Description</th> </tr> </thead> <tbody> <tr> <td>ASI-49-94A</td> <td>545-4559-003</td> <td>Cable 1: ASI-499-1/2/4 to External Power</td> </tr> <tr> <td>ASI-49-94B</td> <td>545-4604-004</td> <td>Cable 2: ASI-499-1/2/4 to HSI Amplifier</td> </tr> <tr> <td>ASI-49-94C</td> <td>545-4605-004</td> <td>Cable 3: ASI-499-1/2/4 to Aircraft Inst Wiring</td> </tr> <tr> <td>ASI-49-94D</td> <td>545-4607-004</td> <td>Cable 4: ASI-499-1/2/4 to HSI 1J2</td> </tr> <tr> <td>ASI-49-94E</td> <td>545-4609-004</td> <td>Cable 5: ASI-499-1/2/4 to HSI 1J1</td> </tr> <tr> <td>ASI-49-94F</td> <td>546-8426-003</td> <td>Cable 7: ASI-499-2/4 to Aircraft Inst Wiring</td> </tr> <tr> <td>ASI-49-94G1</td> <td>548-9600-004</td> <td>Cable 8: ASI-499-2 to AQU-2/A</td> </tr> </tbody> </table>	ASI MN	OEM PN	Description	ASI-49-94A	545-4559-003	Cable 1: ASI-499-1/2/4 to External Power	ASI-49-94B	545-4604-004	Cable 2: ASI-499-1/2/4 to HSI Amplifier	ASI-49-94C	545-4605-004	Cable 3: ASI-499-1/2/4 to Aircraft Inst Wiring	ASI-49-94D	545-4607-004	Cable 4: ASI-499-1/2/4 to HSI 1J2	ASI-49-94E	545-4609-004	Cable 5: ASI-499-1/2/4 to HSI 1J1	ASI-49-94F	546-8426-003	Cable 7: ASI-499-2/4 to Aircraft Inst Wiring	ASI-49-94G1	548-9600-004	Cable 8: ASI-499-2 to AQU-2/A
ASI MN	OEM PN	Description																								
ASI-49-94A	545-4559-003	Cable 1: ASI-499-1/2/4 to External Power																								
ASI-49-94B	545-4604-004	Cable 2: ASI-499-1/2/4 to HSI Amplifier																								
ASI-49-94C	545-4605-004	Cable 3: ASI-499-1/2/4 to Aircraft Inst Wiring																								
ASI-49-94D	545-4607-004	Cable 4: ASI-499-1/2/4 to HSI 1J2																								
ASI-49-94E	545-4609-004	Cable 5: ASI-499-1/2/4 to HSI 1J1																								
ASI-49-94F	546-8426-003	Cable 7: ASI-499-2/4 to Aircraft Inst Wiring																								
ASI-49-94G1	548-9600-004	Cable 8: ASI-499-2 to AQU-2/A																								
<p>Description:</p> <p>The ASI-499-2 Test Set provides facilities for testing the AF/A24J-1 and AQU-2/A Horizontal Situation Indicators. The Test Set supplies test signals to the indicator and determines if the indicator is responding properly.</p> <p>The ASI-499-2 includes the cables required to interconnect to the indicator and the aircraft during testing.</p> <p>The ASI-499-4 (476E-4C) is the suggested replacement for the ASI-499-2 (476E-4A).</p>		Optional Equipment: <table border="1"> <thead> <tr> <th>ASI MN</th> <th>OEM PN</th> <th>Description</th> </tr> </thead> <tbody> <tr> <td>ASI-499-4</td> <td>522-3547-000</td> <td>Horizontal Situation Indicator Test Set</td> </tr> </tbody> </table>	ASI MN	OEM PN	Description	ASI-499-4	522-3547-000	Horizontal Situation Indicator Test Set																		
ASI MN	OEM PN	Description																								
ASI-499-4	522-3547-000	Horizontal Situation Indicator Test Set																								

Horizontal Situation Indicator Test Set		ASI-499-4																								
OEM Equivalent: Rockwell Collins MN: 476E-4C PN: 522-2848-000 Manual: TO 33A1-3-147-31 Fig: 1-1	UUT: AF/A24J-1 / AQU-2/A / AQU-4/A Size: H: 16.0" W: 9.25" D: 14.12" Pwr: 115 VAC 400 Hz	Equipment Supplied: <table border="1"> <thead> <tr> <th>ASI MN</th> <th>OEM PN</th> <th>Description</th> </tr> </thead> <tbody> <tr> <td>ASI-49-94A</td> <td>545-4559-003</td> <td>Cable 1: ASI-499-1/2/4 to External Power</td> </tr> <tr> <td>ASI-49-94B</td> <td>545-4604-004</td> <td>Cable 2: ASI-499-1/2/4 to HSI Amplifier</td> </tr> <tr> <td>ASI-49-94C</td> <td>545-4605-004</td> <td>Cable 3: ASI-499-1/2/4 to Aircraft Inst Wiring</td> </tr> <tr> <td>ASI-49-94D</td> <td>545-4607-004</td> <td>Cable 4: ASI-499-1/2/4 to HSI 1J2</td> </tr> <tr> <td>ASI-49-94E</td> <td>545-4609-004</td> <td>Cable 5: ASI-499-1/2/4 to HSI 1J1</td> </tr> <tr> <td>ASI-49-94F</td> <td>546-8426-003</td> <td>Cable 7: ASI-499-2/4 to Aircraft Inst Wiring</td> </tr> <tr> <td>ASI-49-94G2</td> <td>756-7400-001</td> <td>Cable 8: ASI-499-4 to AQU-2/A or AQU-4/A</td> </tr> </tbody> </table>	ASI MN	OEM PN	Description	ASI-49-94A	545-4559-003	Cable 1: ASI-499-1/2/4 to External Power	ASI-49-94B	545-4604-004	Cable 2: ASI-499-1/2/4 to HSI Amplifier	ASI-49-94C	545-4605-004	Cable 3: ASI-499-1/2/4 to Aircraft Inst Wiring	ASI-49-94D	545-4607-004	Cable 4: ASI-499-1/2/4 to HSI 1J2	ASI-49-94E	545-4609-004	Cable 5: ASI-499-1/2/4 to HSI 1J1	ASI-49-94F	546-8426-003	Cable 7: ASI-499-2/4 to Aircraft Inst Wiring	ASI-49-94G2	756-7400-001	Cable 8: ASI-499-4 to AQU-2/A or AQU-4/A
ASI MN	OEM PN	Description																								
ASI-49-94A	545-4559-003	Cable 1: ASI-499-1/2/4 to External Power																								
ASI-49-94B	545-4604-004	Cable 2: ASI-499-1/2/4 to HSI Amplifier																								
ASI-49-94C	545-4605-004	Cable 3: ASI-499-1/2/4 to Aircraft Inst Wiring																								
ASI-49-94D	545-4607-004	Cable 4: ASI-499-1/2/4 to HSI 1J2																								
ASI-49-94E	545-4609-004	Cable 5: ASI-499-1/2/4 to HSI 1J1																								
ASI-49-94F	546-8426-003	Cable 7: ASI-499-2/4 to Aircraft Inst Wiring																								
ASI-49-94G2	756-7400-001	Cable 8: ASI-499-4 to AQU-2/A or AQU-4/A																								
<p>Description:</p> <p>The ASI-499-4 Test Set provides facilities for testing the AF/A24J-1, AQU-2/A, and AQU-4/A Horizontal Situation Indicators. The Test Set supplies test signals to the indicator and determines if the indicator is responding properly.</p> <p>The ASI-499-4 includes the cables required to interconnect to the indicator and the aircraft during testing.</p> <p>The ASI-499-4 (476E-4C) is the suggested replacement for the ASI-499-1 (476E-4) and the ASI-499-2 (476E-4A).</p>		Optional Equipment: <table border="1"> <thead> <tr> <th>ASI MN</th> <th>OEM PN</th> <th>Description</th> </tr> </thead> <tbody> <tr> <td></td> <td></td> <td></td> </tr> </tbody> </table>	ASI MN	OEM PN	Description																					
ASI MN	OEM PN	Description																								

Flight Director Computer Test Set		ASI-499-5															
OEM Equivalent: Rockwell Collins MN: 476E-1 PN: 522-1431-004 Manual: TO 33A1-3-147-21 Fig: 1-1	UUT: CPU-4/A Size: H: 20.0" W: 9.25" D: 14.00" Pwr: 115 VAC 400 Hz	Equipment Supplied: <table border="1"> <thead> <tr> <th>ASI MN</th> <th>OEM PN</th> <th>Description</th> </tr> </thead> <tbody> <tr> <td>ASI-49-96A</td> <td>545-4557-003</td> <td>Cable 1: ASI-499-5/6 to AC Power</td> </tr> <tr> <td>ASI-49-96B</td> <td>545-4596-003</td> <td>Cable 2: ASI-499-5/6 to 478C-2</td> </tr> <tr> <td>ASI-49-96C</td> <td>545-4615-004</td> <td>Cable 3: ASI-499-5/6 to CPU-4/A</td> </tr> <tr> <td>ASI-49-96D</td> <td>545-4616-004</td> <td>Cable 4: ASI-499-5/6 to CPU-4/A and Indicator</td> </tr> </tbody> </table>	ASI MN	OEM PN	Description	ASI-49-96A	545-4557-003	Cable 1: ASI-499-5/6 to AC Power	ASI-49-96B	545-4596-003	Cable 2: ASI-499-5/6 to 478C-2	ASI-49-96C	545-4615-004	Cable 3: ASI-499-5/6 to CPU-4/A	ASI-49-96D	545-4616-004	Cable 4: ASI-499-5/6 to CPU-4/A and Indicator
ASI MN	OEM PN	Description															
ASI-49-96A	545-4557-003	Cable 1: ASI-499-5/6 to AC Power															
ASI-49-96B	545-4596-003	Cable 2: ASI-499-5/6 to 478C-2															
ASI-49-96C	545-4615-004	Cable 3: ASI-499-5/6 to CPU-4/A															
ASI-49-96D	545-4616-004	Cable 4: ASI-499-5/6 to CPU-4/A and Indicator															
<p>Description:</p> <p>The ASI-499-5 Test Set provides facilities for testing the CPU-4/A Aircraft Flight Director Computer. The ASI-499-5 is a portable test set and can be used on the flight line as well as in the maintenance shop.</p> <p>The ASI-499-5 includes the cables required to interconnect to the CPU-4/A during testing.</p> <p>The ASI-499-6 (476E-1A) is the suggested replacement for the ASI-499-5 (476E-1) as it adds capability to test CPU-4/A's that were not manufactured by Rockwell Collins.</p>		Optional Equipment: <table border="1"> <thead> <tr> <th>ASI MN</th> <th>OEM PN</th> <th>Description</th> </tr> </thead> <tbody> <tr> <td>ASI-499-6</td> <td>522-2848-000</td> <td>Flight Director Computer Test Set (476E-1A)</td> </tr> <tr> <td>ASI-499-61</td> <td>NPN</td> <td>Special Test Fixture for 476E-1/1A (Fig 5-1)</td> </tr> </tbody> </table>	ASI MN	OEM PN	Description	ASI-499-6	522-2848-000	Flight Director Computer Test Set (476E-1A)	ASI-499-61	NPN	Special Test Fixture for 476E-1/1A (Fig 5-1)						
ASI MN	OEM PN	Description															
ASI-499-6	522-2848-000	Flight Director Computer Test Set (476E-1A)															
ASI-499-61	NPN	Special Test Fixture for 476E-1/1A (Fig 5-1)															

Flight Director Computer Test Set		ASI-499-6																		
OEM Equivalent: Rockwell Collins MN: 476E-1A PN: 522-2848-004 Manual: TO 33A1-3-147-21 Fig: 1-2	UUT: CPU-4/A (Collins and Non-Collins) Size: H: 20.0" W: 9.25" D: 14.00" Pwr: 115 VAC 400 Hz	Equipment Supplied: <table border="1"> <thead> <tr> <th>ASI MN</th> <th>OEM PN</th> <th>Description</th> </tr> </thead> <tbody> <tr> <td>ASI-49-96A</td> <td>545-4557-003</td> <td>Cable 1: ASI-499-5/6 to AC Power</td> </tr> <tr> <td>ASI-49-96B</td> <td>545-4596-003</td> <td>Cable 2: ASI-499-5/6 to 478C-2</td> </tr> <tr> <td>ASI-49-96C</td> <td>545-4615-004</td> <td>Cable 3: ASI-499-5/6 to CPU-4/A</td> </tr> <tr> <td>ASI-49-96D</td> <td>545-4616-004</td> <td>Cable 4: ASI-499-5/6 to CPU-4/A and Indicator</td> </tr> <tr> <td>ASI-49-96E</td> <td>545-2501-003</td> <td>Cable 5: ASI-499-6 to Non Collins CPU-4/A</td> </tr> </tbody> </table>	ASI MN	OEM PN	Description	ASI-49-96A	545-4557-003	Cable 1: ASI-499-5/6 to AC Power	ASI-49-96B	545-4596-003	Cable 2: ASI-499-5/6 to 478C-2	ASI-49-96C	545-4615-004	Cable 3: ASI-499-5/6 to CPU-4/A	ASI-49-96D	545-4616-004	Cable 4: ASI-499-5/6 to CPU-4/A and Indicator	ASI-49-96E	545-2501-003	Cable 5: ASI-499-6 to Non Collins CPU-4/A
ASI MN	OEM PN	Description																		
ASI-49-96A	545-4557-003	Cable 1: ASI-499-5/6 to AC Power																		
ASI-49-96B	545-4596-003	Cable 2: ASI-499-5/6 to 478C-2																		
ASI-49-96C	545-4615-004	Cable 3: ASI-499-5/6 to CPU-4/A																		
ASI-49-96D	545-4616-004	Cable 4: ASI-499-5/6 to CPU-4/A and Indicator																		
ASI-49-96E	545-2501-003	Cable 5: ASI-499-6 to Non Collins CPU-4/A																		
<p>Description:</p> <p>The ASI-499-6 Test Set provides facilities for testing the CPU-4/A Aircraft Flight Director Computer. The ASI-499-6 is a portable test set and can be used on the flight line as well as in the maintenance shop.</p> <p>The ASI-499-6 includes the cables required to interconnect to the CPU-4/A during testing.</p> <p>The ASI-499-6 (476E-1A) is the suggested replacement for the ASI-499-5 (476E-1) as it adds capability to test CPU-4/A's that were not manufactured by Rockwell Collins.</p>		Optional Equipment: <table border="1"> <thead> <tr> <th>ASI MN</th> <th>OEM PN</th> <th>Description</th> </tr> </thead> <tbody> <tr> <td>ASI-499-61</td> <td>NPN</td> <td>Special Test Fixture for 476E-1/1A (Fig 5-1)</td> </tr> </tbody> </table>	ASI MN	OEM PN	Description	ASI-499-61	NPN	Special Test Fixture for 476E-1/1A (Fig 5-1)												
ASI MN	OEM PN	Description																		
ASI-499-61	NPN	Special Test Fixture for 476E-1/1A (Fig 5-1)																		

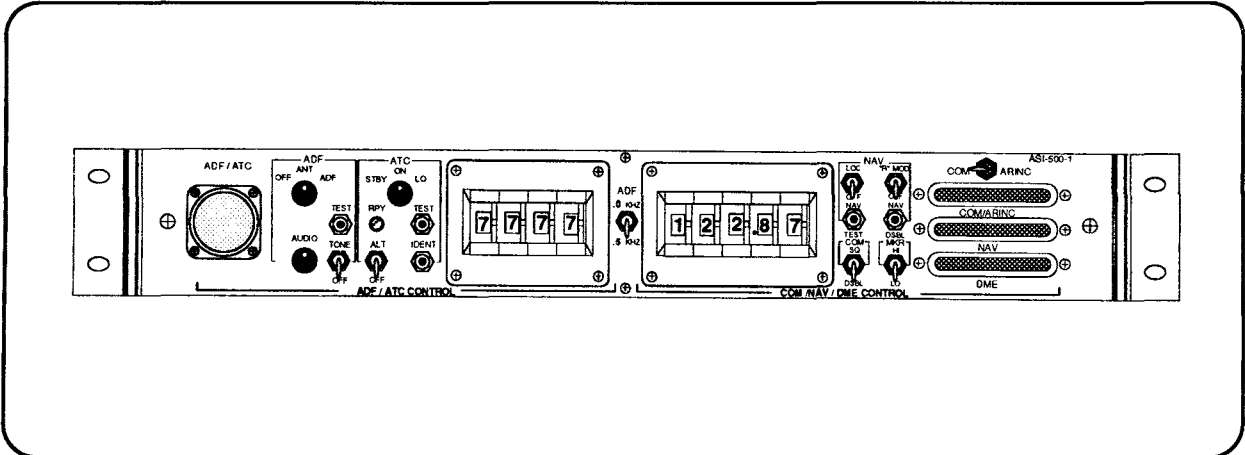

Equivalent OEM:
 Equivalent MN:
 Equivalent PN:
 Manual Figure:

Units Tested:
 Simulates control of various COMM, NAV,
 ADF, DME, and Transponder Systems

Description of Operation:

The ASI-500-1 Control Head Simulator is a stand alone universal avionics control system capable of controlling a wide range of communications transceivers, navigation units, ADF, DME, and transponder systems. The ASI-500 may be paired with virtually any interface panel system whenever the control application requires parallel BCD or 2X5 switching for the UUT. The ASI-500 interconnects directly to the ASI-2000 (via the supplied ASI-10-500A cable) for manual testing of Pro Line units.

The ASI-500-2 is identical to the ASI-500-1 except that it also has the ability to tune 8.33 kHz spacing per ARINC-566A

An optional AC inverter (ASI-600-1) is available which mounts directly on the rear of the ASI-500. The AC Inverter converts 28 vdc to 26 vac 400 Hz required for VOR navigation synchro bearing excitation. The AC inverter may be purchased separate (ASI-600-1) for existing ASI-500-1's or purchased installed on the ASI-500 indicated by the AC behind the ASI-500 model number.

The ASI-500 is available in four different configurations:

- ASI-500-1 Standard Control Head Simulator (without ARINC 566A capability)
- ASI-500-1AC Standard Control Head Simulator with AC Inverter (ASI-600-1) installed
- ASI-500-2 Control Head Simulator with ARINC 566A (8.33 kHz) capability
- ASI-500-2AC Control Head Simulator with ARINC 566A (8.33 kHz) capability with AC Inverter (ASI-600-1) installed

Specifications:

Height: 3.50" Width: 19.00" Depth: 13.00" Power: None required or 28 vdc for AC units

Equipment Supplied:

ASI MN	Equivalent PN	Description
ASI-10-500A		Cable: ASI-500 to ASI-2000

Optional Equipment:

ASI MN	Equivalent PN	Description
ASI-600-1		AC Inverter: Converts 28 vdc to 26 vac 400 Hz

COMM Control Head Simulator

ASI-501-1

Description:

The ASI-501-1 ARINC-566/566A control simulator provides channeling capability required for testing VHF communications equipment. The ASI-501-1 is capable of channeling 2x5 (both 25 kHz and 8.33 kHz channel spacing) per ARINC-566/566A characteristics.

The ASI-501-1 is designed to mount into Linaire LT-5 test panels in place of the LTC-X controls.

The ASI-501-1 is not approved for aircraft installation.

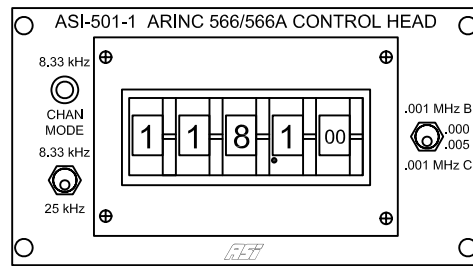

Height: 2.75" Width: 5.75" Depth: 3.00" Mating Conn: DB-25S

COMM Control Head Simulator

ASI-501-2

Description:

The ASI-501-2 ARINC-566/566A control simulator provides channeling capability required for testing VHF communications equipment. The ASI-501-2 is capable of channeling 2x5 (both 25 kHz and 8.33 kHz channel spacing) per ARINC-566/566A characteristics.

The ASI-501-2 is designed to mount into new or existing test panels and conforms to ARINC mounting size requirements.

The ASI-501-2 is not approved for aircraft installation.

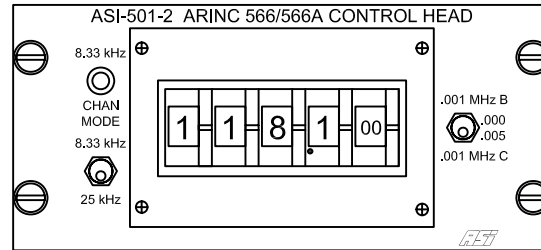

Height: 2.625" Width: 5.75" Depth: 3.00" Mating Conn: DB-25S

COMM Control Head Simulator

ASI-501-3

Description:

The ASI-501-3 ARINC-566/566A control simulator provides channeling capability required for testing VHF communications equipment. The ASI-501-3 is capable of channeling 2x5 (both 25 kHz and 8.33 kHz channel spacing). The ASI-501-3 includes a volume control and test switch.

The ASI-501-3 is replaces the Collins 313N-2/3 COMM control in test panels and conforms to ARINC mounting size requirements.

The ASI-501-3 in not approved for aircraft installation.

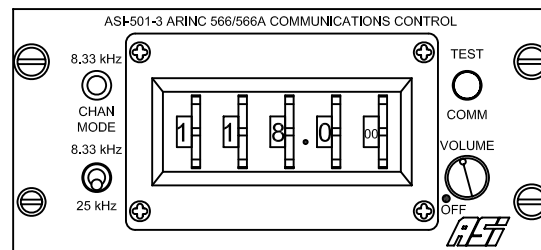

Height: 2.625" Width: 5.75" Depth: 3.00" Mating Conn: MS3126F20-41SW

NAV Control Head Simulator

ASI-501-4

Description:

The ASI-501-4 ARINC-410 control simulator provides channeling capability required for testing various navigation equipment. The ASI-501-4 is capable of channeling 2x5 and includes volume and control switching.

The ASI-501-4 replaces the Collins 313N-2/3 NAV control in test panels and conforms to ARINC mounting size requirements.

The ASI-501-4 in not approved for aircraft installation.

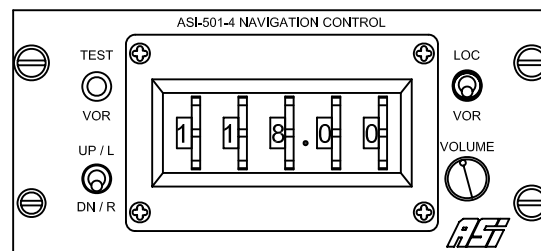

Height: 2.625" Width: 5.75" Depth: 3.00" Mating Conn: MS3126F20-41S

ADF Control Head Simulator

ASI-501-5

Description:

The ASI-501-5 ARINC-570 control simulator provides channeling capability required for testing various ADF equipment. The ASI-501-5 is capable of channeling BCD and includes gain and control switching.

The ASI-501-5 replaces the Collins 614L-11 ADF control in test panels (ASI-185 / 970G-1 and ASI-193 / 477V-2) and conforms to ARINC mounting size requirements.

The ASI-501-5 in not approved for aircraft installation.

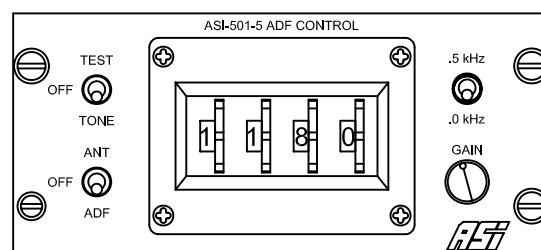

Height: 2.625" Width: 5.75" Depth: 3.00" Mating Conn: MS3126F20-41S R2



It's Small!!

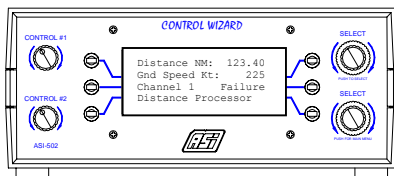

(Front View)

Shown with Optional IND-42 Simulator Program

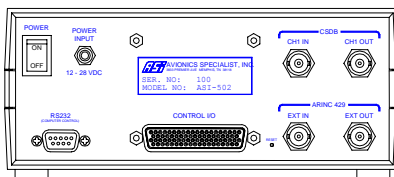

(Rear View)

8.1" Wide x 3.3" High x 6.4" Deep

Includes:

WDU18-1000 AC Power Adapter
17HD078PAA I/O Mating Connector

It's Feature Rich!!

The **CONTROL WIZARD** emulates many standard avionics control head functions making it an ideal control substitute for bench and flight line testing.

Its bright Vacuum-Fluorescent screen can be seen in most any lighting condition.

Complete with these programs:

(1) 429 BIT WIZARD	COM 2X5
(2) CSDB WIZARD	COM ARINC-429
ADF ARINC-429	COM CSDB
ADF BCD	HF ARINC-429
ADF CSDB	NAV 2X5
ATC ARINC-429	NAV ARINC-429
ATC BCD	NAV CSDB
ATC CSDB	VOR OMNIBEARING

Plus, there is plenty of memory for more. We are adding new programs all the time!

Custom programming is available.

Each **WIZARD** program is an individual module. Adding new programs is a simple task through its RS-232 computer connection. Our talented staff listens to our customers and delivers results.

It's Upgradeable!!!

The **CONTROL WIZARD** improves with age. How? It's like this... We are committed to maximizing its value for your dollar. Our engineering department realizes that your avionics shop has special needs from time to time. Ours does! That is exactly why we made it easy to upgrade with new programs and adapters.

The right connectivity.

Optional Adapter boards easily mount on the rear to provide the correct connector to match your existing cables.

ASI-50-2A	ASI-500-1/2 COMM/DME/NAV
ASI-50-2B	ASI-500-1/2 ADF/ATC/613L-3
ASI-50-2C1	IND-42
ASI-50-2C	CTL-20
ASI-50-2D	CTL-30
ASI-50-2E	CTL-60
ASI-50-2F	CTL-90
ASI-50-2G	CTL-22/22A/22C
ASI-50-2H	CTL-23/23C/32/32A
ASI-50-2J	CTL-62/62A
ASI-50-2K	CTL-92/92A
ASI-50-2L	CTL-92T
ASI-50-2M	313N-4D
ASI-50-2N	614-11/12/13

Data Bus Analyzer Capabilities

(1) ARINC 429 Bit Wizard

Transmit:	ARINC-429 32-bit Data
Bit Rates	12.0 Khz, 12.5 Khz, 14.5 Khz., and 100 Khz ±0.05% at 12.5 Khz and 100 Khz
Parity	Odd, Even, None (Off)
Outputs	1 of 3 selectable outputs
Words	Up to 32 with mixed or unique labels
Word Rates	1ms to 9999ms ±2ms with 5 pre-sets
Word Gap	4 Bit minimum
Triggers	2 Opto-isolated inputs
Burst Mode	Adjustable for 1 to 99 words
Display	Hex, Binary 32 to 1, and Binary 1 to 32
Output Levels	±10 VDC (Line A to Line B)
Output Impedance	78 Ohms
Receive:	ARINC-429 32-bit Data
Bit Rate	7.5 Khz to 14.5 Khz, and 100 Khz
Parity	Odd, Even, None (Off)
Inputs	1 of 3 selectable inputs
Receive memory	256 Labels per SDI (1024 words)
Word Rate	Calculates received words to ±2ms
Filters	8 dynamic Data filters
Display	Hex, Binary 32 to 1, and Binary 1 to 32
Total Input Impedance	8K minimum, 9.5K typical
Traps:	Trap on Filter options
Trap Memory	1023 Words plus Trap Event Word
Trap Alarm	Audible tone, On or Off
Trap Event Modes	Event and All Labels, Event and Filter Data
Display	Hex, Binary 32 to 1, and Binary 1 to 32
Trap Storage	Adjustable 1023 to 0 Post-Event Words and 0 to 1023 Pre-Event words

(2) CSDB Wizard

Transmit:	Commercial Standard Data Bus (CSDB)
Bit Rate	12.5 Khz ±0.05% (Standard rate)
Parity	Fixed Odd
Outputs	1 of 2 selectable outputs
Messages	Up to 32 with mixed or unique Addresses
Preset Message Rates	50ms, 100ms, 200ms, 333ms, and 500ms
Adjustable Message Rate	10ms to 9999ms
Frame Synch	11 Bit minimum
Triggers	2 Opto-isolated inputs
Burst Mode	Adjustable for 1 to 99 messages
Display	Hex and Binary
Receive:	Commercial Standard Data Bus (CSDB)
Bit Rate	12.5 Khz ±0.05% (Standard rate)
Parity	Fixed Odd
Inputs	1 of 2 selectable inputs
Receive memory	256 Addresses / Messages
Message Rate	Calculates received words to ±2ms
Filters	8 dynamic filters
Display	Hex and Binary
Total Input Impedance	6K Typical, 4K minimum
Traps:	Trap on Filter options
Trap Memory	1023 Messages plus Trap Event Message
Trap Alarm	Audible tone, On or Off
Trap Event Modes	Event and All Addresses, Event and Filter Data
Display	Hex and Binary
Trap Storage	Adjustable 1023 to 0 Post-Event Words and 0 to 1023 Pre-Event words

(3) Power Requirement: 12 to 28 VDC, ¾ Amp



Additional Information

(3) 115 VAC to 18 VDC Wall Transformer is included.

26 Open-Collector Outputs:	High Current, 500 ma	2 Opto-Isolated Inputs:	60 ma Forward Current	Dimensions:	8.1" Wide x 3.3" High x 6.4" Deep
1 Power Relay:	Single-pole, 10 Amp	2 Potentiometers:	5K, Linear, ½ Watt	Weight:	40 ounces
2 Signal Relays:	Single-pole, 500 ma	1 RS-232 Port:	9600 Baud I/O		



ARINC 700 Indicator Discrete Function Interface Unit

ASI-700-1

Description:

The ASI-700-1 Indicator Discrete Function Interface Unit (DFIU) is designed to test the Collins ARINC 700 series indicators. This DFIU works in conjunction with a user supplied ARINC 429 Data Bus Generator (T1200 or equivalent multi-port ARINC 429 Data Bus Generator) to provide the LRU with all voltages, discretes, control inputs, and outputs required for "by the book" testing per the Collins maintenance manuals. Multiple ASI-502's (single output) may be used in place of the multi-port ARINC 429 Data Bus Generator.

The ASI-700-1 and an ASI-502 with the optional Slow Slew Test Program (ASI-502-0019) provide slow slew testing of the RDMI-743 / RMI-733 compass card and bearing pointers.

Accessory test cables and equipment utilized in the testing of the Collins Indicators are listed in the Optional Equipment Section.

Units Tested:

Model	Part Number	Test Cable
DDI-713	622-5990-001/-302 / S242T404-301/-302	ASI-70-1A
RMI-733	622-5002-203/-205/-206/-207/-501/-502/-503/-701	ASI-70-1B S242T403-204/-205/-206/-207
RMI-733A	622-6084-001	ASI-70-1C
RDMI-743	622-5001-104/-106/-107/-108/-109/-110/-111/-113	ASI-70-1D
	622-5001-501/-502/-503/-504/-601/-602/-701	
	S242T403-104/-106/-107/-108/-109/-110/-111/-113	
RDMI-743B	822-0918-001/-100	
RDMI-743	622-5001-112 / S242T403-112	ASI-70-1E
RDMI-743	622-5001-003	ASI-70-1F
RDMI-743A	622-5818-001	
RAI-742	622-5773-001	ASI-70-1G

Equipment Supplied:

ASI MN	OEM PN	Description
	HBL-7555	AC Mating Connector

Height: 8.75" Width: 19.00" Depth: 6.00" Power: 115 VAC 400 Hz

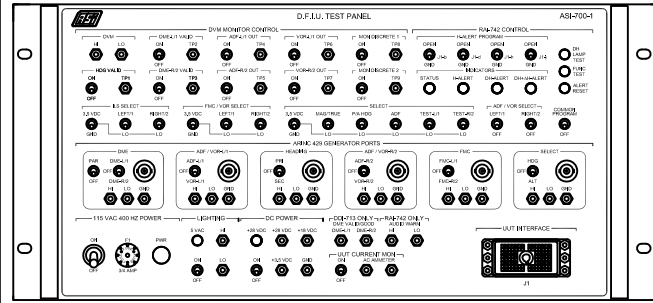

Optional Equipment:

ASI MN	OEM PN	Description
ASI-25-9A	647-6485-005	RAI-742/339H-6 Servo Alignment Pin No. 3
ASI-25-9B	647-6485-004	RAI-742/339H-6 Servo Alignment Pin No. 4
ASI-25-9C	647-6485-001	RDMI/RMI Servo Alignment Pin No. 1
ASI-25-9D	647-6485-002	RDMI/RMI Servo Alignment Pin No. 2
ASI-70-1A	NPN	Test Cable: DDI-713
ASI-70-1B	NPN	Test Cable: RMI-733
ASI-70-1C	NPN	Test Cable: RMI-733A
ASI-70-1D	NPN	Test Cable: RDMI-743/RDMI-743B
ASI-70-1E	NPN	Test Cable: RDMI-743
ASI-70-1F	NPN	Test Cable: RDMI-743/RDMI-743A
ASI-70-1G	NPN	Test Cable: RAI-742
ASI-70-1HA	NPN	RDMI-743 Extender Cable Kit
ASI-70-1HB	NPN	DDI-713 Extender Cable Kit
ASI-70-1HC	NPN	RMI-733 Extender Cable Kit
ASI-70-1HD	NPN	RAI-742 Extender Cable Kit
ASI-70-1J1	NPN	Variable Pwr Interrupt Tester (Standard)
ASI-70-1J2	NPN	Variable Pwr Interrupt Tester (T1200/T1204)
ASI-70-1K	NPN	RAI-742 One-To-One Breakout Box
ASI-259-L	NPN	RAI-742/339H-6 Left Tape Winding Fixture
ASI-259-R	NPN	RAI-742/339H-6 Right Tape Winding Fixture
ASI-502	NPN	Single Input/Output ARINC 429 Generator
ASI-502-0019	NPN	Slow Slew Test Program for ASI-502
ASI-702	NPN	RDMI/RMI DEM Test Fixture
ASI-703	NPN	DEM Mechanical Zeroing/Calibration Fixture
ASI-704	NPN	RDMI/RMI Power Supply Tester

ADF/ILS/MB/VOR Discrete Function Interface Unit

ASI-700-2

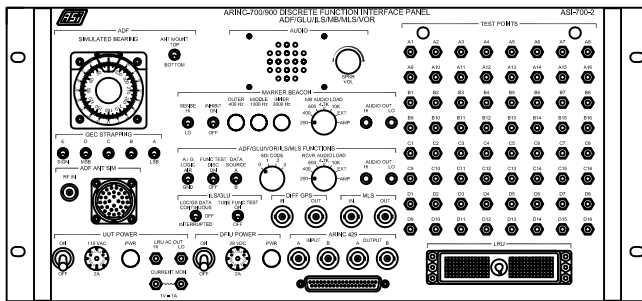

Description:

The ASI-700-2 Discrete Function Interface Unit (DFIU) is functionally equivalent to the T1201 and is designed to test the Honeywell (Bendix) and Rockwell Collins ARINC 700/900 series of ADF, ILS, MB, and VOR Line Replaceable Units (LRU).

The ASI-700-2 works in conjunction with an ARINC 429/629 Data Bus Generator (T1200 or equivalent) to provide the LRU with all voltages, discretes, control inputs and outputs required for "by-the-book" testing per the maintenance manual. Testing of the Honeywell LRU's is done utilizing the Optional Test Procedures shown in the appendix of the LRU maintenance manual.

The optional ASI-502 can be used as an ADF/ILS/VOR ARINC 429 control head simulator (The ASI-502 will not take the place of the T1200). Accessory test cables, test point overlays, and various test fixtures are listed in the Optional Equipment Section.

Units Tested:

ADF-700	ILS-700	VOR-700	DFA-75A
ADF-900	ILS-700A	VOR-700A	RIA-35A
	ILS-720	VOR-900	RVA-36A
	ILS-900		

Height: 8.75" Width: 19.00" Depth: 6.00" Power: 28 VDC/115 VAC 400 Hz

Equipment Supplied:

ASI MN	OEM PN	Description
	HBL-2513	AC Mating Connector
	HBL-7464V	DC Mating Connector

Optional Equipment:

ASI MN	OEM PN	Description
ASI-70-0XA	NPN	Cable: ASI-700-2/-3/-4 to T1200()
ASI-70-02A	NPN	Cable: ADF-700 / ADF-900 / DFA-75A
ASI-70-02A1	NPN	Test Point Overlay: ADF-700
ASI-70-02A2	NPN	Test Point Overlay: ADF-900
ASI-70-02A3	NPN	Test Point Overlay: DFA-75A
ASI-70-02B	NPN	Cable: ILS-700 / ILS-720 / ILS-900 / RIA-35A
ASI-70-02B1	NPN	Test Point Overlay: ILS-700
ASI-70-02B2	NPN	Test Point Overlay: ILS-720
ASI-70-02B3	NPN	Test Point Overlay: RIA-35A
ASI-70-02B4	NPN	Test Point Overlay: ILS-900
ASI-70-02C	NPN	Cable: VOR-700 / VOR-900 / RVA-36A
ASI-70-02C1	NPN	Test Point Overlay: VOR-700
ASI-70-02C2	NPN	Test Point Overlay: VOR-900
ASI-70-02C3	NPN	Test Point Overlay: RVA-36A
ASI-70-02F	NPN	ILS-700/720 Glideslopes Filter
ASI-70-02G	NPN	ILS-700/720 Power Supply A8 Extensions
ASI-70-02H	628-8209-001	ILS-700/720 Loading Tool
ASI-70-02J	NPN	ILS-720 A1A18 Extension Block
ASI-70-02K	NPN	DFA-701/901 Interconnect Test Cable
ASI-22-1F	NPN	51RV-4/-5/ILS-700 N1 DC Source
ASI-713	622-6102-001	Micro Test Adapter (MST-903)
ASI-714	827-0200-003	Ident Signal Generator (Morse Code Gen.)
ASI-715-1	NPN	ILS-700 A1 Tuning Cover
ASI-715-2	628-8364-001	ILS-700 Test Cover
ASI-722-3	2039960-050	Cooling Tray

DME/LRA Discrete Function Interface Unit

ASI-700-3

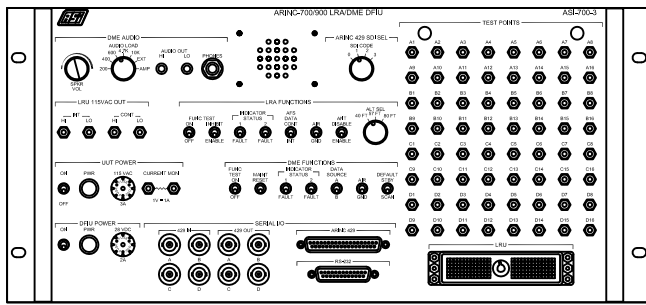

Description:

The ASI-700-3 Discrete Function Interface Unit (DFIU) is functionally equivalent to the T1203 and is designed to test the Rockwell Collins ARINC 700/900 series of DME and Radio Altimeter Line Replaceable Units (LRU).

The ASI-700-3 works in conjunction with an ARINC 429/629 Data Bus Generator (T1200 or equivalent) to provide the LRU with all voltages, discretes, control inputs and outputs required for "by-the-book" testing per the maintenance manual.

The optional ASI-502 can be used as an DME/LRA ARINC 429 control head simulator (The ASI-502 will not take the place of the T1200). Accessory test cables, test point overlays, and various test fixtures are listed in the Optional Equipment Section.

Units Tested: DME-700 DME-900 LRA-700 LRA-900

Equipment Supplied:

ASI MN	OEM PN	Description
	HBL-5669C	AC Mating Connector
	HBL-7464V	DC Mating Connector

Optional Equipment:

ASI MN	OEM PN	Description
ASI-502	NPN	ARINC 429 Control Head Simulator
ASI-70-0XA	NPN	Cable: ASI-700-2/-3/-4 to T1200()
ASI-70-03A	NPN	Cable: DME-700 / DME-900
ASI-70-03A1	NPN	Test Point Overlay: DME-700
ASI-70-03A2	NPN	Test Point Overlay: DME-900
ASI-70-03B	NPN	Cable: LRA-700 / LRA-900
ASI-70-03B1	NPN	Test Point Overlay: LRA-700
ASI-70-03B2	NPN	Test Point Overlay: LRA-900
ASI-70-03C	NPN	Cable: ERT-530
ASI-70-03C1	NPN	Test Point Overlay: ERT-530
ASI-70-03D	NPN	LRA-900 RF Transmitter Tuning Tool
ASI-706	622-6103-001	Micro Test Adapter (MST-904)
ASI-707A	646-3781-001	DME-700/900 A4 Alignment Cover
ASI-707B	646-3780-001	DME-700/900 A3 Alignment Cover
ASI-707C	646-3759-001	DME-700/900 A5 Alignment Cover
ASI-708	NPN	DME-700/900 Suppressor Load
ASI-716	622-6104-001	Micro Test Adapter (MST-905)
ASI-717	NPN	LRA-700/900 Altitude Simulator Fixture
ASI-718	647-5733-002	LRA-700/900 RF Tuning Cover
ASI-719	NPN	LRA-700 Pulse Gen Test Box

Height: 8.75" Width: 19.00" Depth: 6.00" Power: 28 VDC/115 VAC 400 Hz

HF/VHF Discrete Function Interface Unit

ASI-700-4

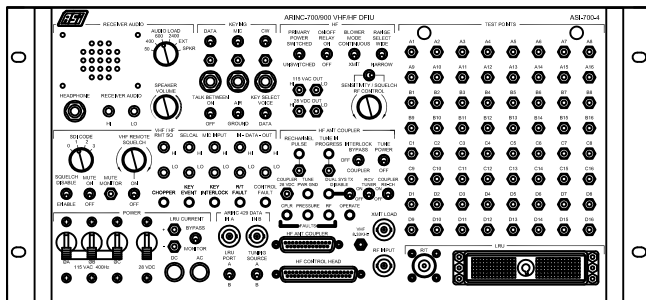

Description:

The ASI-700-4 Discrete Function Interface Unit (DFIU) is functionally equivalent to the T1202 and is designed to test the Honeywell (Bendix) and Rockwell Collins ARINC 700/900 series of HF and VHF Line Replaceable Units (LRU). The ASI-700-4 also has the ability to test the Collins HF Antenna Couplers (490S-1 and CPL-920D).

The ASI-700-4 works in conjunction with an ARINC 429/629 Data Bus Generator (T1200 or equivalent) to provide the LRU with all voltages, discretes, control inputs, and outputs required for "by-the-book" testing per the maintenance manual. Testing of the Honeywell LRU's is done utilizing the Optional Test Procedures shown in the appendix of the LRU maintenance manual.

The optional ASI-502 can be used as an ARINC 429 control head simulator (The ASI-502 will not take the place of the T1200A). Optional test cables, test point overlays, and various test fixtures are listed in the Optional Equipment Section.

Optional Equipment:

ASI MN	OEM PN	Description
ASI-502	NPN	ARINC 429 Control Head Simulator
ASI-70-0XA	NPN	Cable: ASI-700-2/-3/-4 to T1200()
ASI-70-04A	NPN	Cable: VHF-700/700A/700B / RTA-44A
ASI-70-04A1	NPN	Test Overlay: VHF-700/700A/700B
ASI-70-04A2	NPN	Test Overlay: RTA-44A
ASI-70-04B	NPN	Cable: HFS-700/900 / 628T-2/-2A
ASI-70-04B1	NPN	Test Overlay: HFS-700/900 / 628T-2/-2A
ASI-70-04C	NPN	ARINC-753 HFDL Voice Interface Panel for 628T-2D / HFS-700D/900D / CPL-920D
ASI-70-04C1	NPN	Cable: CPL-920D / 490S-1 J1
ASI-70-04D	NPN	Cable: VHF-900/900B (Test Overlay Not Req)
ASI-70-04E	NPN	Cable: 628T-1()
ASI-70-04E1	NPN	Test Overlay: 628T-1()
ASI-70-04G	NPN	Cable: 714E-1
ASI-70-04H	NPN	Cable: 714E-2
ASI-70-04J	NPN	Cable: 714E-3/6
ASI-70-04K	NPN	Cable: ASI-700-4 Control Plug to ASI-502
ASI-70-04P	NPN	HFS-700/900/628T-2 A5 Alignment Fixture
ASI-70-04Q1	628-5274-001	VHF-700 A2 Adjustment Cover
ASI-70-04Q2	628-8351-001	VHF-700 Adjustment Cover
ASI-70-04R	NPN	RTA-44A Series Detector Circuit
ASI-70-04S	NPN	HFDL Data Load Cable
ASI-70-04T		Cable: HFP-712
ASI-70-04U	315-5167-001	Cable: RTA-83A
ASI-70-04U1		Test Overlay, RTA-83A
ASI-70-04V		Cable: VHF-920 (Test Overlay Not Required)
ASI-207	622-0158-001	Test Bench Harness (477W-7)
ASI-207-1	622-0180-001	Antenna Simulator (172H-18)
ASI-207-3	NPN	CPL-920D RF High Voltage Test Fixture
ASI-207-4	822-1176-001	CPL-920D Control Card Test Set (967R-2)
ASI-207-5	752-8896-001	CPL-920D Power Supply Test Set (TE1)
ASI-207-6	989-2159-001	CPL-920D MIMS Discriminator Tester (TE2)
ASI-207-7	989-2167-001	CPL-920D RF Network Test Set (TE3)
ASI-207-8	989-2168-001	CPL-920D RF Network Holding Fixture (TE4)
ASI-207-9	989-2169-001	CPL-920D Calibration Fixture (TE5)
ASI-207-10	989-2146-001	CPL-920D 90 Degree Phase Shift Network
ASI-207-11	989-2146-002	CPL-920D 0 Degree Power Divider
ASI-207-12	989-2146-007	CPL-920D RF Test Cable
ASI-207-13	652-2443-001	CPL-920D Test Adapter
ASI-700-4-01	983-4904-001	Oscilloscope Logic Probe
ASI-700-4-02	983-4924-001	Power Supply Load Test Fixture
ASI-700-4-03	830-7415-101	Translator Tester
ASI-700-4-04	830-7934-001	Blower A4A2 Test Fixture
ASI-700-4-05	647-2143-001	Chassis/Power Supply Test Fixture
ASI-700-4-06	NPN	Unity Gain Amplifier Circuit Fixture
ASI-700-4-07	NPN	Voltage Regulator A6A3 Tester
ASI-700-4-08	830-7754-001	Control Box Assembly - Bandswitch Adapter
ASI-711	NPN	500-Ohm T-Attenuator
ASI-712	NPN	RF Injection Probe (50-Ohm)
ASI-803-1	303-0005-001	2X5 Tuning Panel for RTA-83A

Units Tested:	VHF-700	HFS-700	490S-1	RTA-44A
	VHF-700A	HFS-900	628T-1	RTA-83A
	VHF-700B	HFS-700D	628T-2	
	VHF-900	HFS-900D	628T-2A	
	VHF-900B	CPL-920D	628T-2D	
	VHF-920			

Equipment Supplied:

ASI MN	OEM PN	Description
	HBL-5669C	AC Mating Connector
	HBL-7464V	DC Mating Connector

Height: 8.75" Width: 19.00" Depth: 6.00" Power: 28 VDC/115 VAC 400 Hz

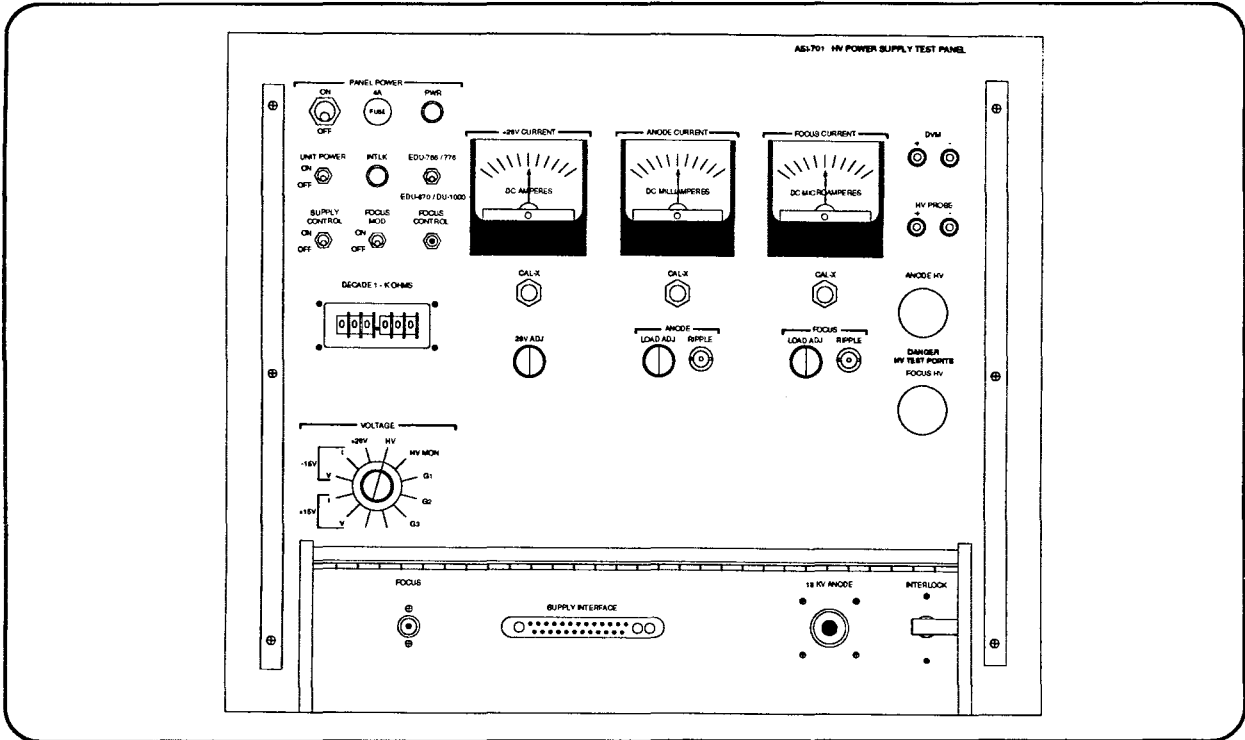

This unit is manufactured to replace the OEM model and/or part number listed below in form, fit, and function.

Equivalent OEM: Rockwell Collins
 Equivalent MN:
 Equivalent PN: 652-9764-001
 Manual Figure:

Units Tested:
 EDU-766/776 and EDU-870/ DU-1000

Description of Operation:

The ASI-701 is configured to test the high voltage power supply of the Collins EDU-766/776 and EDU-870/ DU-1000 Electronic Display Units. It features protected HV test points, a protective shield for the UUT, and an interlock switch for safety. The ASI-701 can be rack-mounted or stand alone.

Specifications:

Height: 17.00" Width: 19.00" Depth: 15.00"

Power: 115 VAC 60 Hz

Equipment Supplied:

ASI MN	Equivalent PN	Description
ASI-701-1A	AMP # 830395-1	Cable: Focus HV Lead
ASI-701-1B	AMP # 846814-1	Cable: 18 KV Anode HV Lead
ASI-701-1C	647-8076-004	Cable: Supply Interface

Optional Equipment:

ASI MN	Equivalent PN	Description
--------	---------------	-------------

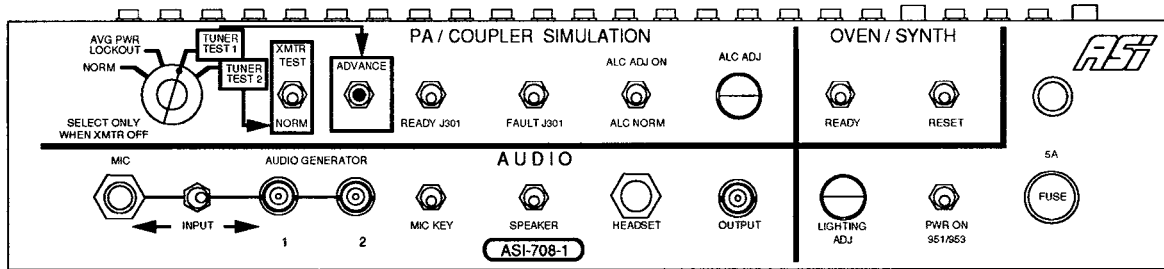

This unit is manufactured to replace the OEM model and/or part number listed below in form, fit, and function.

Equivalent OEM: Bendix/King
 Equivalent MN: KTS-157
 Equivalent PN: 071-5040-00
 Manual Figure:

Units Tested:
 KCU-951 Controller
 KAC-952 PA/Coupler (With ASI-70-8B)
 KTR-953 Receiver/Exciter
 KFS-594 Control Unit (With ASI-70-8A)

Description of Operation:

The ASI-708-1 facilitates testing of the KHF-950 HF/ SSB System. System boxes may be operated together or KAC-952 PA/Coupler can be simulated to allow testing of KCU-951 Controller and KTR-953 receiver/exciter. The test set provides Microphone, Audio Generator, and Headset inputs with an Audio Amplifier and Internal Speaker to facilitate testing. The ASI-708-1 test set provides for simulation of Fault and Ready signals for the KAC-952 PA/Coupler. The test set also has a Reset Switch to initialize the KCU-951 microprocessor program. The test set also includes hardwired cables for hookup to system boxes.

Specifications:

Height: 3.00" Width: 14.00" Depth: 10.00" Power: +15 to +35 VDC

Equipment Supplied:

ASI MN	Equivalent PN	Description
--------	---------------	-------------

Optional Equipment:

ASI MN	Equivalent PN	Description
ASI-70-8A	071-5078-00	KAC/KFS-594 Test Set Adapter
ASI-70-8B	071-5045-00	Antenna Simulator

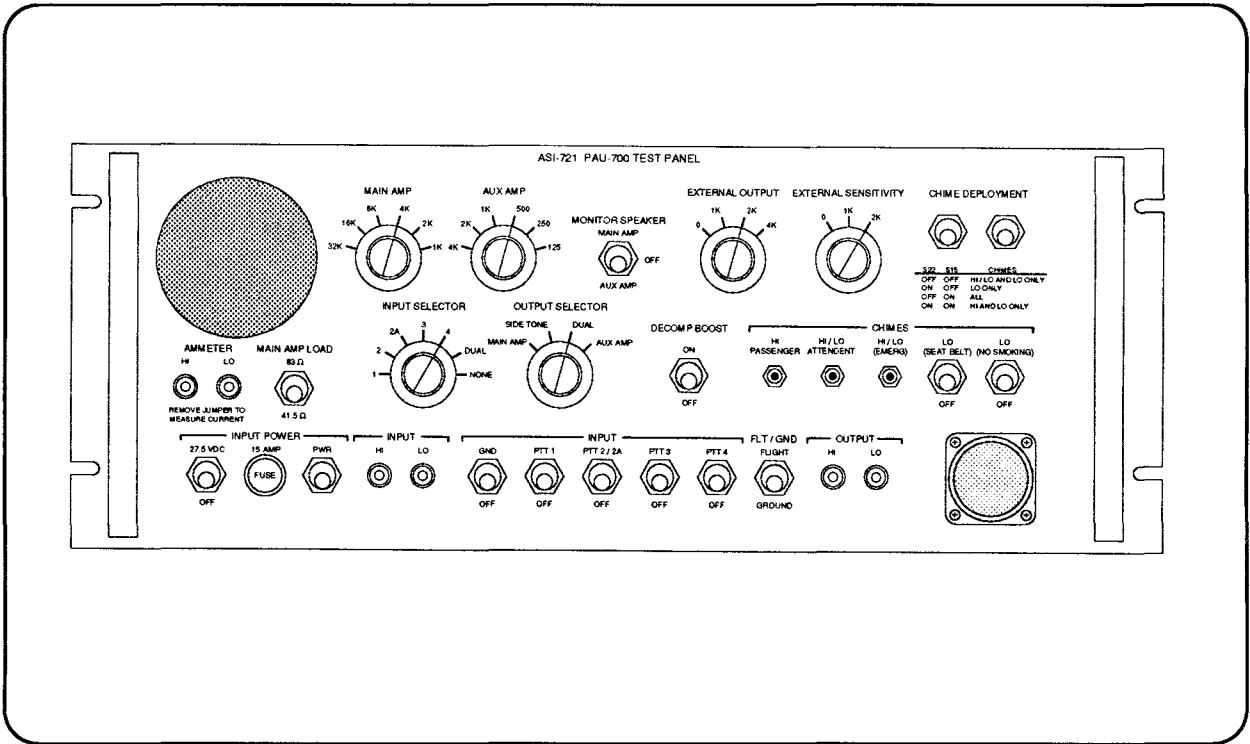

This unit is manufactured to replace the OEM model and/or part number listed below in form, fit, and function.

Equivalent OEM: Collins

Equivalent MN:

Equivalent PN:

Manual Figure: PAU-700 Fig. 902-904

Units Tested:

PAU-700 Passenger Address Unit

Description of Operation:

The ASI-721 Test Fixture provides a means to test and troubleshoot the Collins PAU-700 Passenger Address Unit. The Test Fixture comes complete with UUT cable (ASI-72-1A). The ASI-720, a 26 dB L-pad attenuator as called for in the Collins manual, is also available as an optional item.

Specifications:

Height: 7.00 " Width: 19.00" Depth: 6.75"

Power: +28 VDC

Equipment Supplied:

ASI MN	Equivalent PN	Description
ASI-72-1A		Cable: ASI-721 to PAU-700

Optional Equipment:

ASI MN	Equivalent PN	Description
ASI-720	Fig. 901A, PAU-700 Manual	26 dB L-pad attenuator

WMA Radar Antenna Test Equipment		ASI-WMA-701X/702X									
Leveling Base		ASI-725									
Description: The ASI-725 Leveling Base is used to establish level reference during alignment procedures of the WMA-701X/702X Radar Antenna.	OEM Equivalent: OEM: Collins Model Number: Part Number: Manual Number: 523-0769563 Manual Figure: 902	Units Tested: WMA-701X WMA-702X									
Optional Equipment: <table border="1"> <thead> <tr> <th>ASI MN</th> <th>OEM PN</th> <th>Description</th> </tr> </thead> <tbody> <tr> <td>ASI-72-5A</td> <td>NPN</td> <td>Alignment Pins, 0.120" x 3.0"</td> </tr> <tr> <td>ASI-72-5B</td> <td>40068</td> <td>Circular Level</td> </tr> </tbody> </table>	ASI MN	OEM PN	Description	ASI-72-5A	NPN	Alignment Pins, 0.120" x 3.0"	ASI-72-5B	40068	Circular Level	Specifications: Height: 2.00" Width: 16.00" Depth: 14.00" Power: N/A	
ASI MN	OEM PN	Description									
ASI-72-5A	NPN	Alignment Pins, 0.120" x 3.0"									
ASI-72-5B	40068	Circular Level									
Motor Driver Test Fixture		ASI-726									
Description: The ASI-726 Motor Driver Test Fixture is used to test / troubleshoot the motor driver circuit card assemblies A2/A10 (676-6860-XXX/ 676-6861-XXX) in the WMA-701X / WMA-702X Radar Antenna.	OEM Equivalent: OEM: Collins Model Number: Part Number: 647-1997-001 Manual Number: 523-0769563 Manual Figure: 906A-906C	Units Tested: WMA-701X 622-5135-201/-202/-203 WMA-702X 622-5136-201/-202/-203									
Optional Equipment: <table border="1"> <thead> <tr> <th>ASI MN</th> <th>OEM PN</th> <th>Description</th> </tr> </thead> <tbody> <tr> <td></td> <td></td> <td></td> </tr> </tbody> </table>	ASI MN	OEM PN	Description				Specifications: Height: 8.00" Width: 12.00" Depth: 3.00" Power: N/A				
ASI MN	OEM PN	Description									
Antenna Weight Simulator		ASI-728									
Description: The ASI-728 Antenna Weight Simulator is used in place of the antenna flat plate during alignment procedures of the WMA-701X/ WMA-702X.	OEM Equivalent: OEM: Collins Model Number: Part Number: Manual Number: 523-0769563 Manual Figure: 903	Units Tested: WMA-701X WMA-702X									
Optional Equipment: <table border="1"> <thead> <tr> <th>ASI MN</th> <th>OEM PN</th> <th>Description</th> </tr> </thead> <tbody> <tr> <td>ASI-72-8A</td> <td></td> <td>Alternate Flange</td> </tr> </tbody> </table>	ASI MN	OEM PN	Description	ASI-72-8A		Alternate Flange	Specifications: Height: 8.294" Width: 8.294" Depth: 1.375" Power: N/A				
ASI MN	OEM PN	Description									
ASI-72-8A		Alternate Flange									
Power Supply Test Fixture		ASI-729									
Description: The ASI-729 Power Supply Test Fixture is used to test and troubleshoot the power supplies (A1/A9) in the WMA-701X/702X Radar Antenna.	OEM Equivalent: OEM: Collins Model Number: 647-0283-001 Part Number: Manual Number: 523-0769563 Manual Figure: 904 - 906	Units Tested: WMA-701X WMA-702X									
Optional Equipment: <table border="1"> <thead> <tr> <th>ASI MN</th> <th>OEM PN</th> <th>Description</th> </tr> </thead> <tbody> <tr> <td></td> <td></td> <td></td> </tr> </tbody> </table>	ASI MN	OEM PN	Description				Specifications: Height: 8.00" Width: 12.00" Depth: 3.00" Power: 115 VAC 400 Hz				
ASI MN	OEM PN	Description									
Motor Driver Test Fixture		ASI-731									
Description: The ASI-731 Motor Driver Test Fixture is used to test / troubleshoot the motor driver circuit card assemblies A2/A10 (641-0401-001/ 634-2111-001) in the WMA-701X / WMA-702X Radar Antenna.	OEM Equivalent: OEM: Collins Model Number: Part Number: Manual Number: 523-0769563 Manual Figure: 907-909	Units Tested: WMA-701X 622-5135-001/-002/-003 622-5135-101/-102 WMA-702X 622-5136-001/-002/-003									
Optional Equipment: <table border="1"> <thead> <tr> <th>ASI MN</th> <th>OEM PN</th> <th>Description</th> </tr> </thead> <tbody> <tr> <td></td> <td></td> <td></td> </tr> </tbody> </table>	ASI MN	OEM PN	Description				Specifications: Height: 8.00" Width: 12.00" Depth: 3.00" Power: 115 VAC 60 Hz				
ASI MN	OEM PN	Description									
Receiver/Monitor Driver Test Fixture		ASI-732									
Description: The ASI-732 Receiver/Monitor Driver Test Fixture is used to test and troubleshoot the receiver/monitor driver circuit card assemblies (A3/A11) in the WMA-701X / WMA-702X Radar Antenna.	OEM Equivalent: OEM: Collins Model Number: Part Number: Manual Number: 523-0769563 Manual Figure: 909A-909C	Units Tested: WMA-701X WMA-702X									
Optional Equipment: <table border="1"> <thead> <tr> <th>ASI MN</th> <th>OEM PN</th> <th>Description</th> </tr> </thead> <tbody> <tr> <td></td> <td></td> <td></td> </tr> </tbody> </table>	ASI MN	OEM PN	Description				Specifications: Height: 8.00" Width: 12.00" Depth: 3.00" Power: 115 VAC 60 Hz				
ASI MN	OEM PN	Description									

WMA Radar Antenna Test Equipment				ASI-WMA-701X/702X																																			
Preload Spring Torque Adapter				ASI-733																																			
Description: The ASI-733 Preload Spring Torque Adapter is used to check / set elevation gear assembly preload torque in the WMA-701X/702X		OEM Equivalent: OEM: Collins Model Number: Part Number: Manual Number: 523-0769563 Manual Figure: 910		Units Tested: WMA-701X WMA-702X																																			
Optional Equipment: <u>ASI MN</u> <u>OEM PN</u> <u>Description</u>		Specifications: Height: 1.50" Width: 1.50" Depth: 1.50" Power: N/A																																					
Zero Monitors A5 and A7 Mounting Jig				ASI-734																																			
Description: The ASI-734 Zero Monitors A5 and A7 Mounting Jig is used as an assembly aid for the WMA-701X/702X		OEM Equivalent: OEM: Collins Model Number: Part Number: Manual Number: 523-0769563 Manual Figure: 911		Units Tested: WMA-701X WMA-702X																																			
Optional Equipment: <u>ASI MN</u> <u>OEM PN</u> <u>Description</u>		Specifications: Height: 0.60" Width: 0.75" Depth: 1.50" Power: N/A																																					
Zero Monitors A5 and A7 Mounting Probe				ASI-735																																			
Description: The ASI-735 Zero Monitors A5 and A7 Mounting Probe is used as an assembly aid for the WMA-701X/702X		OEM Equivalent: OEM: Collins Model Number: Part Number: Manual Number: 523-0769563 Manual Figure: 912		Units Tested: WMA-701X WMA-702X																																			
Optional Equipment: <u>ASI MN</u> <u>OEM PN</u> <u>Description</u>		Specifications: Height: 0.30" Width: 0.09" Depth: 5.00" Power: N/A																																					
Coil Spring Torque Adapter				ASI-736																																			
Description: The ASI-736 Coil Spring Torque Adapter is used to check / set elevation coil spring torque in the WMA-701X/702X.		OEM Equivalent: OEM: Collins Model Number: Part Number: Manual Number: 523-0769563 Manual Figure: 913		Units Tested: WMA-701X WMA-702X																																			
Optional Equipment: <u>ASI MN</u> <u>OEM PN</u> <u>Description</u>		Specifications: Height: 0.375" Width: 1.00" Depth: 2.5" Power: N/A																																					
Waveguide Flange				ASI-737																																			
Description: The ASI-737 Waveguide Flange is used with waveguide adapter to test WMA-701X/702X antenna pedestal insertion loss.		OEM Equivalent: OEM: Collins Model Number: Part Number: Manual Number: 523-0769563 Manual Figure: 914		Units Tested: WMA-701X WMA-702X																																			
Optional Equipment: <u>ASI MN</u> <u>OEM PN</u> <u>Description</u>		Specifications: Height: 1.93" Width: 1.98" Depth: .750" Power: N/A																																					
Airborne Gear Shimming Kit				ASI-3831-001																																			
Description: The ASI-3831-001 Airborne Gear Shimming Kit provides the tools required to properly shim the elevation and scan gear assemblies of the WMA-701X/702X. The tools come packaged in a rugged plastic storage case.		OEM Equivalent: OEM: Collins Model Number: Part Number: 830-3831-001 Manual Number: 523-0769563 Manual Figure: 915-921		Units Tested: WMA-701X WMA-702X																																			
Equipment Included: <table border="1"> <thead> <tr> <th><u>ASI MN</u></th> <th><u>OEM PN</u></th> <th><u>Man. Fig.</u></th> <th><u>Description</u></th> </tr> </thead> <tbody> <tr> <td>ASI-3829-001</td> <td>830-3829-001</td> <td>915</td> <td>Shimming Pry Tool No. 6</td> </tr> <tr> <td>ASI-3830-001</td> <td>830-3830-001</td> <td>916</td> <td>Shimming Pry Tool No. 7</td> </tr> <tr> <td>ASI-3364-001</td> <td>830-3364-001</td> <td>917</td> <td>Shimming Pry Tool No. 5</td> </tr> <tr> <td>ASI-3358-001</td> <td>830-3358-001</td> <td>918</td> <td>Shimming Pry Tool No. 1</td> </tr> <tr> <td>ASI-3360-001</td> <td>830-3360-001</td> <td>919</td> <td>Shimming Pry Tool No. 2</td> </tr> <tr> <td>ASI-763-1</td> <td>830-3359-005</td> <td>920</td> <td>Elev Drive Gear Shimming Fixture</td> </tr> <tr> <td>ASI-763-2</td> <td>830-3359-004</td> <td>921</td> <td>Scan Drive Gear Shimming Fixture</td> </tr> </tbody> </table>		<u>ASI MN</u>	<u>OEM PN</u>	<u>Man. Fig.</u>	<u>Description</u>	ASI-3829-001	830-3829-001	915	Shimming Pry Tool No. 6	ASI-3830-001	830-3830-001	916	Shimming Pry Tool No. 7	ASI-3364-001	830-3364-001	917	Shimming Pry Tool No. 5	ASI-3358-001	830-3358-001	918	Shimming Pry Tool No. 1	ASI-3360-001	830-3360-001	919	Shimming Pry Tool No. 2	ASI-763-1	830-3359-005	920	Elev Drive Gear Shimming Fixture	ASI-763-2	830-3359-004	921	Scan Drive Gear Shimming Fixture	Optional Equipment: <u>ASI MN</u> <u>OEM PN</u> <u>Description</u>					
<u>ASI MN</u>	<u>OEM PN</u>	<u>Man. Fig.</u>	<u>Description</u>																																				
ASI-3829-001	830-3829-001	915	Shimming Pry Tool No. 6																																				
ASI-3830-001	830-3830-001	916	Shimming Pry Tool No. 7																																				
ASI-3364-001	830-3364-001	917	Shimming Pry Tool No. 5																																				
ASI-3358-001	830-3358-001	918	Shimming Pry Tool No. 1																																				
ASI-3360-001	830-3360-001	919	Shimming Pry Tool No. 2																																				
ASI-763-1	830-3359-005	920	Elev Drive Gear Shimming Fixture																																				
ASI-763-2	830-3359-004	921	Scan Drive Gear Shimming Fixture																																				
		Specifications: Height: N/A Width: N/A Depth: N/A Power: N/A																																					

WXR Radar System Test Equipment		ASI-WXR-700X
WXR Test Rack		ASI-722
Description: The ASI-722 functions as a test platform for the WRT-701X during testing of the WXR-700X radar system. Forced air cooling for extended operation is provided by a blower mounted on the bottom of the test rack.	OEM Equivalent: OEM: Rockwell Collins Model Number: WMT-701X Part Number: 646-4443-009 Manual Number: Manual Figure:	Units Tested: WRT-701X
Optional Equipment: <u>ASI MN</u> <u>OEM PN</u> <u>Description</u>	Specifications: Height: 8.60" Width: 10.30" Depth: 16.00" Power: 115 VAC 60 Hz	
Microprocessor Test Adapter		ASI-723
Description: The ASI-723 Micro.Test Adapter provides interface between the Fluke 9010A Micro-System Troubleshooter (9000-8085) and the WRT-701X cards for the purpose of testing and troubleshooting. Software required for testing must be purchased from Collins.	OEM Equivalent: OEM: Rockwell Collins Model Number: MST-902 Part Number: 622-6101-001 Manual Number: 523-0772862 Manual Figure:	Units Tested: WRT-701X Cards: A10 Turb Proc Card A12 CPU Card A13 I/O Card A14 Sync/Dig Card
Optional Equipment: <u>ASI MN</u> <u>OEM PN</u> <u>Description</u>	Specifications: Height: 1.30" Width: 4.00" Depth: 7.40" Power: 5 VDC	
WRT-701X Test Breakout Box		ASI-724
Description: The ASI-724 provides test points for monitoring WXR-700X system operation. The ASI-724 plugs directly into the front test connector on the WRT-701X Radar R/T to gain access to test signals.	OEM Equivalent: OEM: Rockwell Collins Model Number: Part Number: Manual Number: 523-0769561 Manual Figure: 505-506	Units Tested: WRT-701X
Optional Equipment: <u>ASI MN</u> <u>OEM PN</u> <u>Description</u>	Specifications: Height: 8.00" Width: 12.00" Depth: 2.50" Power: N/A	
WXI-711 Front Panel Extender Cable		ASI-727
Description: The ASI-727 simulates the front panel switches and controls of the WXI-711 indicator for testing and troubleshooting. It provides interconnection between the front panel and the CPU (A7) board.	OEM Equivalent: OEM: Rockwell Collins Model Number: Part Number: Manual Number: 523-0773309 Manual Figure: 903	Units Tested: WXI-711
Optional Equipment: <u>ASI MN</u> <u>OEM PN</u> <u>Description</u> ASI-72-7A A7 Extender Cable (50 Pin) ASI-72-7B A9 Extender Cable (24 Pin) ASI-72-7C A8 Extender Cable (46 Pin) ASI-72-7D Front Panel Extender Cable (34 Pin)	Specifications: Height: 4.00" Width: 6.00" Depth: 2.00" Power: N/A	
WXI-711 Rear Connector Breakout Box		ASI-730-1
Description: The ASI-730-1 interconnects the WXI-711 rear connector to the DF-7708 test cable to provide test points for monitoring the AUX Data, AUX BUS, and XY Sel signals.	OEM Equivalent: OEM: Rockwell Collins Model Number: Part Number: Manual Number: 523-0769563 Manual Figure: 907-909	Units Tested: WXI-711 (Non-TCAS)
Optional Equipment: <u>ASI MN</u> <u>OEM PN</u> <u>Description</u>	Specifications: Height: 4.00" Width: 6.00" Depth: 2.00" Power: N/A	
WXI-711 TCAS Rear Connector Breakout Box		ASI-730-2
Description: The ASI-730-2 interconnects the WXI-711 rear connector to the DF-7708 test cable to provide test points for monitoring the TCAS Data, Remote Display Enable, and T/A Display status signals.	OEM Equivalent: OEM: Rockwell Collins Model Number: Part Number: Manual Number: 523-0776158 Manual Figure: 904-905	Units Tested: WXI-711 (TCAS)
Optional Equipment: <u>ASI MN</u> <u>OEM PN</u> <u>Description</u>	Specifications: Height: 4.00" Width: 6.00" Depth: 2.00" Power: N/A	

WXR Radar System Test Equipment		ASI-WXR-700X																																																																														
WXR-700X J-Box		ASI-738																																																																														
Description: The ASI-738 J-Box will exercise all the components of the WXR-700X together as a system. The ASI-738 provides power, test points, switching, and system interconnection required for testing. The ASI-738 includes modifications that are required for testing units with M/S and FLW. The ASI-738 also has all the functions of the CFM Discrete Switch Box (WXR-700X Man. Fig. 507) incorporated into this test fixture.	OEM Equivalent: OEM: Rockwell Collins Model Number: WJB-701 Part Number: 622-5760-001 Manual Number: 523-0769561 Manual Figure: 503-504, 507	Units Tested: WXR-700X System: WRT-701X WXI-701 / WXI-711 WCP-701 / WCP-702 WMA-701 / WMA-702																																																																														
Specifications: Height: 12.00" Width: 8.00" Depth: 3.00" Power: 115 VAC 400 Hz	Optional Equipment: <table border="1"> <thead> <tr> <th>ASI MN</th> <th>OEM PN</th> <th>Description</th> </tr> </thead> <tbody> <tr> <td>ASI-73-8A</td> <td>NPN</td> <td>DF-7708/Indicator Interface Cable</td> </tr> <tr> <td>ASI-73-8B</td> <td>NPN</td> <td>RS-232 Test Cable for WRT-701X(FLW)</td> </tr> <tr> <td>ASI-165</td> <td>522-6330-001</td> <td>Synchro Simulator Panel (CSS-10)</td> </tr> <tr> <td>ASI-167</td> <td>522-3498-000</td> <td>Synchro Simulator Panel (978F-2S)</td> </tr> <tr> <td>ASI-7994-701X</td> <td>659-7994-002</td> <td>WRT-701X RF Alignment Kit (WRF-708X)</td> </tr> </tbody> </table>		ASI MN	OEM PN	Description	ASI-73-8A	NPN	DF-7708/Indicator Interface Cable	ASI-73-8B	NPN	RS-232 Test Cable for WRT-701X(FLW)	ASI-165	522-6330-001	Synchro Simulator Panel (CSS-10)	ASI-167	522-3498-000	Synchro Simulator Panel (978F-2S)	ASI-7994-701X	659-7994-002	WRT-701X RF Alignment Kit (WRF-708X)																																																												
ASI MN	OEM PN	Description																																																																														
ASI-73-8A	NPN	DF-7708/Indicator Interface Cable																																																																														
ASI-73-8B	NPN	RS-232 Test Cable for WRT-701X(FLW)																																																																														
ASI-165	522-6330-001	Synchro Simulator Panel (CSS-10)																																																																														
ASI-167	522-3498-000	Synchro Simulator Panel (978F-2S)																																																																														
ASI-7994-701X	659-7994-002	WRT-701X RF Alignment Kit (WRF-708X)																																																																														
WRT-701X Turbulance Test Controller																																																																																
Description: The ASI-739 Turbulance Test Controller will test the WRT-701X Turbulance Processor Board (A10).		Units Tested: WRT-701X																																																																														
Optional Equipment: <table border="1"> <thead> <tr> <th>ASI MN</th> <th>OEM PN</th> <th>Description</th> </tr> </thead> <tbody> <tr> <td>ASI-76-4A</td> <td>NPN</td> <td>Signature Analysis Test Probe (Grabber/Mini Hook)</td> </tr> <tr> <td>ASI-76-4B</td> <td>NPN</td> <td>Signature Analysis Test Probe (Mini Hook/Mini Hook)</td> </tr> </tbody> </table>	ASI MN	OEM PN	Description	ASI-76-4A	NPN	Signature Analysis Test Probe (Grabber/Mini Hook)	ASI-76-4B	NPN	Signature Analysis Test Probe (Mini Hook/Mini Hook)	OEM Equivalent: OEM: Rockwell Collins Model Number: Part Number: Manual Number: 523-0769561 / 523-0769562 Manual Figure: 507 / 904-905	Specifications: Height: 4.00" Width: 6.00" Depth: 2.00" Power: N/A																																																																					
ASI MN	OEM PN	Description																																																																														
ASI-76-4A	NPN	Signature Analysis Test Probe (Grabber/Mini Hook)																																																																														
ASI-76-4B	NPN	Signature Analysis Test Probe (Mini Hook/Mini Hook)																																																																														
WCP-701/702 Test Fixture																																																																																
Description: The ASI-764 provides test points and switching required for testing the Collins WCP-701 and WCP-702 Radar Control Panels.		Units Tested: WCP-701 WCP-702																																																																														
Optional Equipment: <table border="1"> <thead> <tr> <th>ASI MN</th> <th>OEM PN</th> <th>Description</th> </tr> </thead> <tbody> <tr> <td>ASI-76-4A</td> <td>NPN</td> <td>Signature Analysis Test Probe (Grabber/Mini Hook)</td> </tr> <tr> <td>ASI-76-4B</td> <td>NPN</td> <td>Signature Analysis Test Probe (Mini Hook/Mini Hook)</td> </tr> </tbody> </table>	ASI MN	OEM PN	Description	ASI-76-4A	NPN	Signature Analysis Test Probe (Grabber/Mini Hook)	ASI-76-4B	NPN	Signature Analysis Test Probe (Mini Hook/Mini Hook)	OEM Equivalent: OEM: Rockwell Collins Model Number: Part Number: Manual Number: 523-0769566 / 523-0775428 / 523-0773862 Manual Figure: 904-905 / 903-904 / 903-904	Specifications: Height: 4.00" Width: 5.00" Depth: 2.00" Power: N/A																																																																					
ASI MN	OEM PN	Description																																																																														
ASI-76-4A	NPN	Signature Analysis Test Probe (Grabber/Mini Hook)																																																																														
ASI-76-4B	NPN	Signature Analysis Test Probe (Mini Hook/Mini Hook)																																																																														
WRT FLW Alignment Kit																																																																																
Description: The ASI-6960-001 FLW Alignment Kit includes test fixtures, extender cables, and tuning covers required to test and align the RF section of the WRT-701X R/T with FLW (Forward Looking Windshear) and WRT-2100. The entire kit comes packaged in a rugged plastic storage case.		Units Tested: WRT-701X (with FLW) WRT-2100																																																																														
Equipment Included: <table border="1"> <thead> <tr> <th>ASI MN</th> <th>OEM PN</th> <th>Man. Fig.</th> <th>Description</th> </tr> </thead> <tbody> <tr> <td>ASI-6943-001</td> <td>830-6943-001</td> <td>910 / 9007</td> <td>Driver Ext Cable & Control Box</td> </tr> <tr> <td>ASI-6944-001</td> <td>830-6944-001</td> <td>911 / 9008</td> <td>2nd IF A8 Ext Cable & Control Box</td> </tr> <tr> <td>ASI-6945-001</td> <td>830-6945-001</td> <td>912 / 9009</td> <td>Noise Diode Switch Box</td> </tr> <tr> <td>ASI-6946-001</td> <td>830-6946-001</td> <td>913 / 9010</td> <td>PREDM Extender Cable</td> </tr> <tr> <td>ASI-6946-002</td> <td>830-6946-002</td> <td>909 / N/A</td> <td>Multiplier Extender Cable</td> </tr> <tr> <td>ASI-6946-003</td> <td>830-6946-003</td> <td>914 / 9011</td> <td>Mixer A7 Extender Cable</td> </tr> <tr> <td>ASI-6946-004</td> <td>830-6946-004</td> <td>N/A</td> <td>RF Extender Cable</td> </tr> <tr> <td>ASI-2756-001</td> <td>830-2756-001</td> <td>922 / N/A</td> <td>Multiplier A5 Tuning Cover</td> </tr> <tr> <td>ASI-6877-001</td> <td>830-6877-001</td> <td>N/A / 9020</td> <td>Sgl Ch Multiplier A5 Tuning Cover</td> </tr> <tr> <td>ASI-6951-001</td> <td>830-6951-001</td> <td>920 / 9018</td> <td>Pwr Amp A4 Tuning Cover (Old)</td> </tr> <tr> <td>ASI-6952-001</td> <td>830-6952-001</td> <td>921 / 9019</td> <td>Pwr Amp A4 Tuning Cover (New)</td> </tr> <tr> <td>ASI-6953-001</td> <td>830-6953-001</td> <td>918 / 9015</td> <td>Preamp Bias/Noise Diode Test Cvr</td> </tr> <tr> <td>ASI-6954-001</td> <td>830-6954-001</td> <td>919 / 9017</td> <td>Driver A3 Tuning Cover</td> </tr> <tr> <td>ASI-5948-001</td> <td>830-5948-001</td> <td>N/A</td> <td>Driver Test Cover (TBA)</td> </tr> </tbody> </table>	ASI MN	OEM PN	Man. Fig.	Description	ASI-6943-001	830-6943-001	910 / 9007	Driver Ext Cable & Control Box	ASI-6944-001	830-6944-001	911 / 9008	2nd IF A8 Ext Cable & Control Box	ASI-6945-001	830-6945-001	912 / 9009	Noise Diode Switch Box	ASI-6946-001	830-6946-001	913 / 9010	PREDM Extender Cable	ASI-6946-002	830-6946-002	909 / N/A	Multiplier Extender Cable	ASI-6946-003	830-6946-003	914 / 9011	Mixer A7 Extender Cable	ASI-6946-004	830-6946-004	N/A	RF Extender Cable	ASI-2756-001	830-2756-001	922 / N/A	Multiplier A5 Tuning Cover	ASI-6877-001	830-6877-001	N/A / 9020	Sgl Ch Multiplier A5 Tuning Cover	ASI-6951-001	830-6951-001	920 / 9018	Pwr Amp A4 Tuning Cover (Old)	ASI-6952-001	830-6952-001	921 / 9019	Pwr Amp A4 Tuning Cover (New)	ASI-6953-001	830-6953-001	918 / 9015	Preamp Bias/Noise Diode Test Cvr	ASI-6954-001	830-6954-001	919 / 9017	Driver A3 Tuning Cover	ASI-5948-001	830-5948-001	N/A	Driver Test Cover (TBA)	Optional Equipment: <table border="1"> <thead> <tr> <th>ASI MN</th> <th>OEM PN</th> <th>Description</th> </tr> </thead> <tbody> <tr> <td>ASI-488</td> <td>279-0176-010</td> <td>Modified Echo Box (TS-488A/UP)</td> </tr> <tr> <td>ASI-7994-701X</td> <td>659-7994-002</td> <td>WRT-701X/2100 RF Alignment Kit</td> </tr> <tr> <td>ASI-983-4838-001</td> <td>983-4838-001</td> <td>Source Aid Test Fixture</td> </tr> <tr> <td>ASI-6900-002</td> <td>830-6900-002</td> <td>A51 Noise Diode Breakout Cable</td> </tr> <tr> <td>ASI-6900-003</td> <td>830-6900-003</td> <td>A50 Source Extender Cable</td> </tr> </tbody> </table>	ASI MN	OEM PN	Description	ASI-488	279-0176-010	Modified Echo Box (TS-488A/UP)	ASI-7994-701X	659-7994-002	WRT-701X/2100 RF Alignment Kit	ASI-983-4838-001	983-4838-001	Source Aid Test Fixture	ASI-6900-002	830-6900-002	A51 Noise Diode Breakout Cable	ASI-6900-003	830-6900-003	A50 Source Extender Cable	Specifications: Height: N/A Width: N/A Depth: N/A Power: N/A
ASI MN	OEM PN	Man. Fig.	Description																																																																													
ASI-6943-001	830-6943-001	910 / 9007	Driver Ext Cable & Control Box																																																																													
ASI-6944-001	830-6944-001	911 / 9008	2nd IF A8 Ext Cable & Control Box																																																																													
ASI-6945-001	830-6945-001	912 / 9009	Noise Diode Switch Box																																																																													
ASI-6946-001	830-6946-001	913 / 9010	PREDM Extender Cable																																																																													
ASI-6946-002	830-6946-002	909 / N/A	Multiplier Extender Cable																																																																													
ASI-6946-003	830-6946-003	914 / 9011	Mixer A7 Extender Cable																																																																													
ASI-6946-004	830-6946-004	N/A	RF Extender Cable																																																																													
ASI-2756-001	830-2756-001	922 / N/A	Multiplier A5 Tuning Cover																																																																													
ASI-6877-001	830-6877-001	N/A / 9020	Sgl Ch Multiplier A5 Tuning Cover																																																																													
ASI-6951-001	830-6951-001	920 / 9018	Pwr Amp A4 Tuning Cover (Old)																																																																													
ASI-6952-001	830-6952-001	921 / 9019	Pwr Amp A4 Tuning Cover (New)																																																																													
ASI-6953-001	830-6953-001	918 / 9015	Preamp Bias/Noise Diode Test Cvr																																																																													
ASI-6954-001	830-6954-001	919 / 9017	Driver A3 Tuning Cover																																																																													
ASI-5948-001	830-5948-001	N/A	Driver Test Cover (TBA)																																																																													
ASI MN	OEM PN	Description																																																																														
ASI-488	279-0176-010	Modified Echo Box (TS-488A/UP)																																																																														
ASI-7994-701X	659-7994-002	WRT-701X/2100 RF Alignment Kit																																																																														
ASI-983-4838-001	983-4838-001	Source Aid Test Fixture																																																																														
ASI-6900-002	830-6900-002	A51 Noise Diode Breakout Cable																																																																														
ASI-6900-003	830-6900-003	A50 Source Extender Cable																																																																														
WRT-701X CPU Board Analyzer																																																																																
Description: The ASI-7000-701X provides clocking signals for the signature analyzer required during testing of the WRT-701X (622-5132-001) CPU Board.		Units Tested: WRT-701X (622-5132-001)																																																																														
Optional Equipment: <table border="1"> <thead> <tr> <th>ASI MN</th> <th>OEM PN</th> <th>Description</th> </tr> </thead> <tbody> <tr> <td>ASI-7000-701X</td> <td>622-5132-001</td> <td>Signature Analyzer</td> </tr> </tbody> </table>	ASI MN	OEM PN	Description	ASI-7000-701X	622-5132-001	Signature Analyzer	OEM Equivalent: OEM: Rockwell Collins Model Number: Part Number: Manual Number: 523-0769562 Manual Figure: 902-903	Specifications: Height: 2.00" Width: 6.00" Depth: 2.5" Power: N/A																																																																								
ASI MN	OEM PN	Description																																																																														
ASI-7000-701X	622-5132-001	Signature Analyzer																																																																														

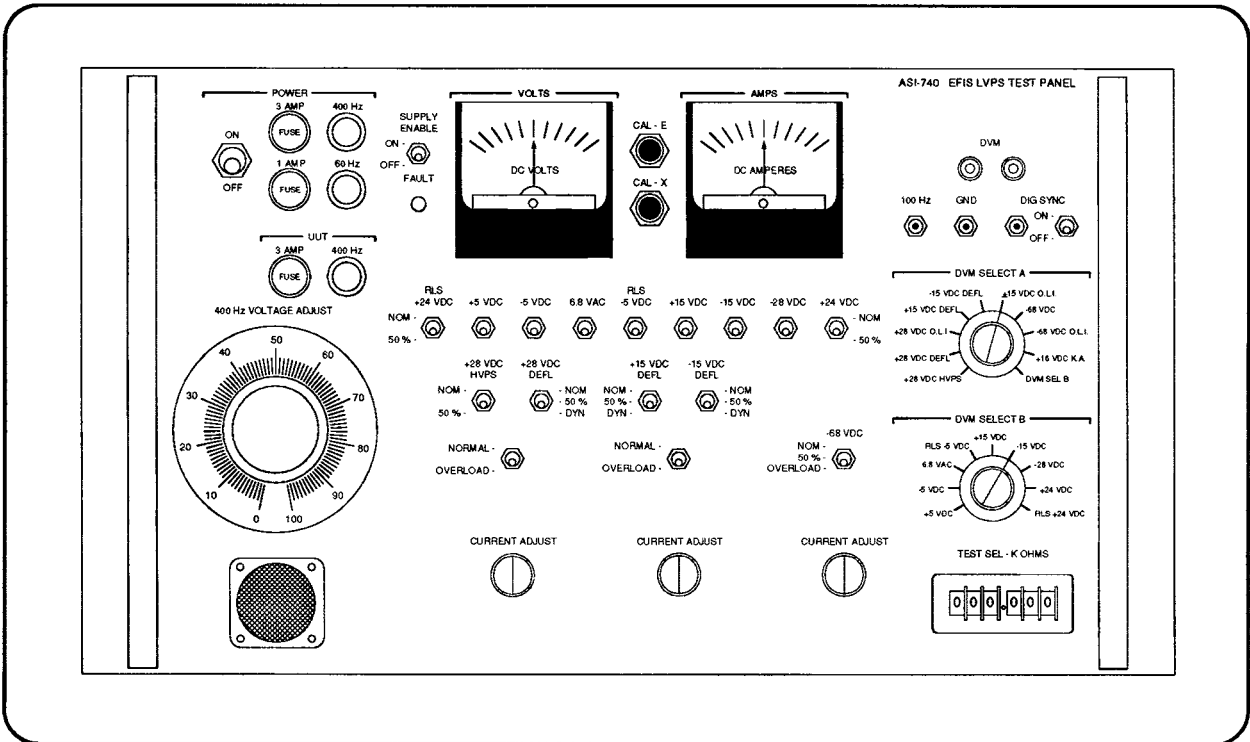

This unit is manufactured to replace the OEM model and/or part number listed below in form, fit, and function.

Equivalent OEM: Collins
 Equivalent MN:
 Equivalent PN: 647-8028-001
 Manual Figure:

Units Tested:
 EDU-766 Electronic Display Unit
 EDU-776 Electronic Display Unit

Description of Operation:

The ASI-740 EFIS LVPS Test Panel is used to test and troubleshoot the low voltage power supply of Collins EDU-766/776 Electronic Display Units. All voltages and loads for operation and testing are provided by the test panel.

Specifications:

Height: 11.50" Width: 19.00" Depth: 8.00"

Power: 115 VAC 60 Hz

Equipment Supplied:

ASI MN	Equivalent PN	Description
ASI-74-0A	647-2036-001	Cable: ASI-740 to EDU-766/776 LVPS

Optional Equipment:

ASI MN	Equivalent PN	Description
ASI-74-0B	647-8158-001	Cable: ASI-740 to Red Label Power Supplies
ASI-74-0C	647-4868-001	Cable: ASI-740 to Black Label Power Supplies

Doppler Signal Generator

ASI-741

OEM Equivalent:

OEM: Bendix
 Model Number: RMT-4A
 Part Number: 8055325-0401
 Manual: I.B. 1104HT / 34-41-62
 Manual Figure: 1

This unit is manufactured to replace the OEM MN, PN, and/or manual figure listed in Form, Fit, and Function.

Description:

The ASI-741 Doppler Signal Generator works in conjunction with the ASI-742 (RCT-4A) and an IFR RDX-3000B / RDX-7708B to test the Bendix RTA-4A Receiver-Transmitter. It provides quadrature modulation signals for turbulence detection testing.

The ASI-741 is designed as a test instrument for ARINC 708 (RTA-4A) series weather radar systems by providing a means of testing the turbulence detection capabilities of the radar transceiver. The ASI-741 works in conjunction with the ASI-742 (RCT-4A) and a radar test set (RDX-3000B or RDX-7708B) to generate simulated weather turbulence and ground returns, which enable a reading and interpretation of the resultant data on the radar test set.

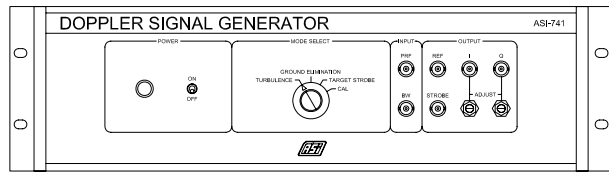

Units Tested:

ARINC-708 Series Weather Radar Systems
 RDR-4A Weather Radar System (RCT-4A)

Specifications:

Height: 5.25" Width: 19.00" Depth: 13.00"
 Power Requirements: 115/230 VAC 47-440 Hz

Equipment Supplied:

ASI MN	OEM PN	Description
--------	--------	-------------

Optional Equipment:

ASI MN	OEM PN	Description
ASI-742	2041589-0401	Radar System Test Panel (RCT-4A)

RDR-4A Radar System Test Panel

ASI-742

OEM Equivalent:

OEM: Bendix
 Model Number: RCT-4A
 Part Number: 2041589-0401
 Manual: I.B. 1104AT / 34-41-55
 Manual Figure: 1

This unit is manufactured to replace the OEM MN, PN, and/or manual figure listed in Form, Fit, and Function.

Description:

The ASI-742 Radar System Test Panel is used in conjunction with a CON-4A/4B Controller, PPI-4B Indicator, RTA-4A R/T, and DAA-4A/4B Antenna Drive Unit to test the RDR-4A Radar System.

The ASI-742 provides a central station for interconnection of the system. The Test Panel generates target range, pulse width and digital or analog altitude signals, and ground speed signals which are transmitted to the R/T. The signals generated by the ASI-742 simulate signals from the antenna and the aircraft. Provision has been made for mounting the CON-4A/4B directly in the front panel.

Testing of the DAA-4B Antenna Drive Unit requires the optional ASI-72-2K adapter cable.

The ASI-741 (RMT-4A) can be used with the ASI-742 to test the turbulence detection functions of the RTA-4A R/T. The ASI-799 (AXT-4A) can be used in conjunction with the ASI-742 to simulate the aircraft CFDS Computer and MCDU Display.

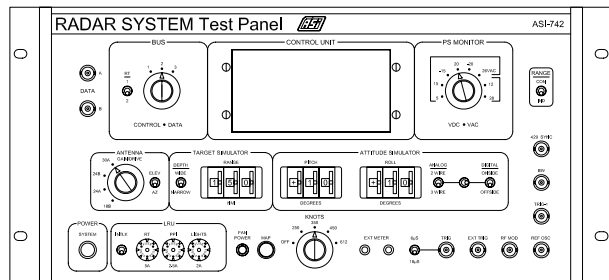

Units Tested:

RDR-4A Weather Radar System
 CON-4A / CON-4B
 DAA-4A / DAA-4B
 PPI-4B
 RTA-4A

Specifications:

Height: 8.75" Width: 19.00" Depth: 13.00"
 Power Requirements: 115 VAC 400 Hz

Equipment Supplied:

ASI MN	OEM PN	Description
ASI-74-2A	2039994-0501	Cable: ASI-742 to PPI-4B (W1)
ASI-74-2B	2039995-0501	Cable: ASI-742 to API (W2)
ASI-74-2C	2039996-0501	Cable: ASI-742 to CON-4A (W3)
ASI-74-2D	2039997-0501	Cable: ASI-742 to DDA-4A (W4)
ASI-74-2E	2039998-0501	Cable: ASI-742 to CON-4B (W5)
ASI-74-2F	2039999-0501	Cable: ASI-742 to ATE (W6)
ASI-74-2G	2040000-0501	Cable: ASI-742 to RTA-4A (W7)

Optional Equipment:

ASI MN	OEM PN	Description
ASI-74-2H	NPN	BNC-T 150 Ohm Load
ASI-74-2J	NPN	SMB/BNC Adapter Cable
ASI-74-2K	2040904-0501	Cable: ASI-742-W4 to DAA-4B Antenna
ASI-77-1E	649-0970-001/2	DAA-4A Dummy Antenna Weight
ASI-741	8055325-0401	Doppler Signal Generator (RMT-4A)
ASI-770	2041886-0401	Radar Antenna Simulator (AST-4A)
ASI-799	8055692-0401	Fault Data Test Unit (AXT-4A)
ASI-169-2	2041793-0401	Radar Test Set (RST-4A)
ASI-252-2	2041593-0401	Radar Control Test Panel (COT-4A)
ASI-722-2	2039960-0501	RTA-4A Test Bench Cooling Tray

TCAS PPT Adapter Test Panel

ASI-743

OEM Equivalent:

OEM: Bendix
 Model Number: AIT-4A
 Part Number: 8074503-0401
 Manual: I.B. 1104KT / 34-41-64
 Manual Figure: 1

This unit is manufactured to replace the OEM MN, PN, and/or manual figure listed in Form, Fit, and Function.

Description:

The ASI-743 TCAS PPT Adapter Test Panel is used in conjunction with the ASI-174 (PPT-1B) or ASI-760 (PPT-4A) to test, align, and troubleshoot TCAS modified PPI-1T, PPI-1U, and PPI-4B Weather Radar Indicators and the ITA-81A Traffic Display. The ASI-743 interfaces to existing test cable harnesses and modification to existing test panels are not required.

The ASI-743 interfaces data and video signals from the existing test panel to the PPI-1T/-1U/-4B Weather Radar Indicator being tested. The necessary operating voltages for the PPI-1T/-1U/-4B are also interfaced through the ASI-743 to the PPI's. ITA-81A operating power is supplied directly from the ASI-743.

The ASI-743's internal TCAS 429 and ACARS 429 generator modules provide the 100 kHz 32 bit serial data required for testing the PPI radar indicators and the ITA-81A.

Four cables required for interconnection and testing of the PPI-1T, PPI-1U, PPI-4B, and ITA-81A are included with the ASI-174.

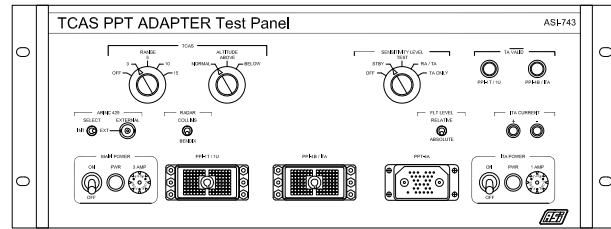

Units Tested:

- PPI-1T
- PPI-1U
- PPI-4B
- ITA-81A

Specifications:

Height: 7.00" Width: 19.00" Depth: 13.00"
 Power Requirements: 115 VAC 400 Hz

Equipment Supplied:

ASI MN	OEM PN	Description
ASI-74-3A	8072626-0502	Cable, ASI-743 to PPI-1T (W1)
ASI-74-3B	8072628-0502	Cable, ASI-743 to PPI-1U (W2)
ASI-74-3C	8072625-0502	Cable, ASI-743 to PPI-4B (W3)
ASI-74-3D	8057438-0501	Cable, ASI-743 to ITA-81A (W4)

Optional Equipment:

ASI MN	OEM PN	Description
ASI-174	2038141-0501	Radar Indicator Test Panel (PPT-1B)
ASI-197	2041323-0101	Radar Test Pattern Generator (PPT-1CG)
ASI-198	2039597-0501	Radar Test Pattern Generator Adapter
ASI-760	2041591-0401	Radar Indicator Test Panel (PPT-4A)

Radar Indicator Test Panel

ASI-760

OEM Equivalent:

OEM: Bendix
 Model Number: PPT-4A
 Part Number: 2041591-0401
 Manual: I.B. 1104DT / 34-41-58
 Manual Figure: 1

This unit is manufactured to replace the OEM MN, PN, and/or manual figure listed in Form, Fit, and Function.

Description:

The ASI-760 Radar Indicator Test Panel functions to test, align, and troubleshoot the PPI-4B Weather Radar Indicator without the use of an R/T or radar control (CON).

The Test Panel has the capability to receive and display ARINC 429 control words, and to generate and transmit ARINC 429 and 453 data words to the PPI-4B. The ARINC 453 words are generated from the ARINC 429 data received, or from internal circuits which can be manipulated using various front panel switches. The ASI-760 also provides and monitors power required to energize the PPI-4B being tested.

The ASI-760 can be used in conjunction with the ASI-743 (AIT-4A) to test PPI-4B Indicators with TCAS capability. An optional cable (ASI-76-0B) is also available that will enable the ASI-760 to test the CCA-4A Checklist Unit.

The ASI-760 includes the PPI-4B interconnect cable.

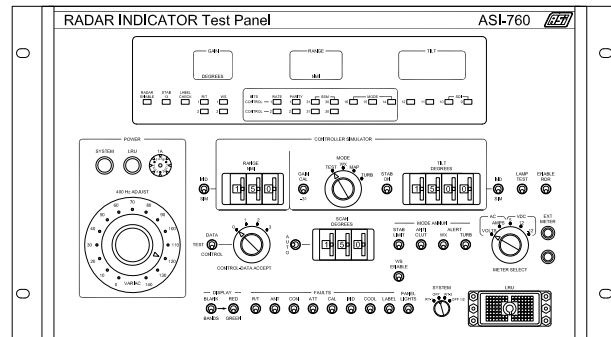

Units Tested:

- PPI-4B
- CCA-4A

Specifications:

Height: 10.50" Width: 19.00" Depth: 13.00"
 Power Requirements: 115 VAC 400 Hz

Equipment Supplied:

ASI MN	OEM PN	Description
ASI-76-0A	2040030-0501	Cable: ASI-760 to PPI-4B (W1)

Optional Equipment:

ASI MN	OEM PN	Description
ASI-197	2041323-0101	Radar Test Pattern Generator (PPT-1CG)
ASI-743	8074503-0401	TCAS PPT Adapter Test Panel (AIT-4A)
ASI-76-0B	8073780-0001	Cable: ASI-760 to CCA-4A
ASI-76-0C	NPN	Power Supply Load for PPI-1T/-1U/-4B

Radar Antenna Simulator Test Panel

ASI-770

OEM Equivalent:

OEM: Bendix
 Model Number: AST-4A
 Part Number: 2041886-0401
 Manual: I.B. 1104FT / 34-41-60
 Manual Figure: 1

This unit is manufactured to replace the OEM MN, PN, and/or manual figure listed in Form, Fit, and Function.

Description:

The ASI-770 Radar Antenna Simulator Test Panel replaces the Bendix DAA-4A Antenna Drive Unit in the RDR-4A Radar System test environment.

The ASI-770 simulates the motor load, mechanical response, and synchro outputs of the antenna drive unit. It responds to elevation and scan drive signals, originating at the RTA-4A Receiver-Transmitter, by feeding back simulated synchro output signals that are representative of the antenna azimuth and elevation motors.

The Test Panel also has the capability of simulating all valid ranges the the RTA-4A responds to, as well as the invalid ranges which the RTA-4A does not respond to. A warning light on the front of the panel comes on when an invalid range is selected at the ASI-770.

The ASI-770 is supplied with two cables required for interface and proper operation.

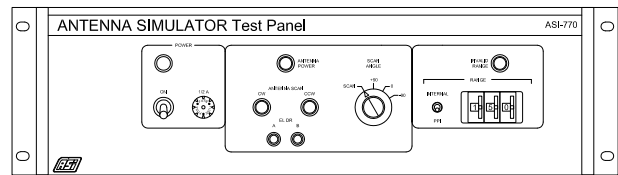

Units Tested:

RDR-4A Weather Radar System
 RTA-4A

Specifications:

Height: 5.25" Width: 19.00" Depth: 13.00"
 Power Requirements: 115 VAC 400 Hz

Equipment Supplied:

ASI MN	OEM PN	Description
ASI-77-0A	2040331-0501	Cable, ASI-770 to ASI-742 / RCT-4A (W10)
ASI-77-0B	2040020-0501	Cable, ASI-770 PWR (W108)

Optional Equipment:

ASI MN	OEM PN	Description
ASI-742	2041589-0401	Radar System Test Panel (RCT-4A)

Radar Antenna Test Panel

ASI-771

OEM Equivalent:

OEM: Bendix
 Model Number: ATT-4A
 Part Number: 2041592-0401
 Manual: I.B. 1104CT / 34-41-57
 Manual Figure: 1

This unit is manufactured to replace the OEM MN, PN, and/or manual figure listed in Form, Fit, and Function.

Description:

The ASI-771 Radar Antenna Test Panel facilitates alignment, testing, and troubleshooting of the Bendix DAA-4A Drive Unit / REA-4() Planer Array Radar Antenna.

The ASI-771 contains circuitry to convert the azimuth synchro transmitter input of the DAA-4A / REA-4() and DAA-4B Radar Antenna into a DC signal which varies with the changing position at the antenna. This DC signal is further processed to control the azimuth drive of the radar antenna through a limited azimuth scan (approx. 120°). The ASI-771 also has the ability to vary the elevation of the antenna in tilt up or tilt down.

The ASI-771 is supplied with four cables required for interface and proper operation.

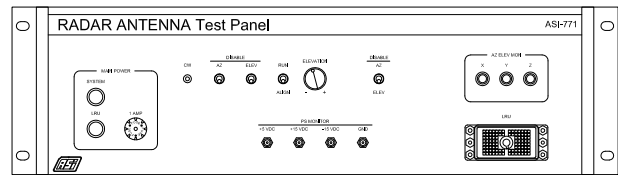

Units Tested:

DAA-4A
 DAA-4B
 REA-4()

Specifications:

Height: 5.25" Width: 19.00" Depth: 13.00"
 Power Requirements: 115 VAC 400 Hz

Equipment Supplied:

ASI MN	OEM PN	Description
ASI-77-1A	2040083-0501	Cable: ASI-771 to DAA-4A (W1)
ASI-77-1B	2040082-0501	Cable: ASI-771 to API (W2)
ASI-77-1C	2040981-0501	Cable: ASI-771 to DAA-4B (W3)
ASI-77-1D	2040020-0501	Cable: ASI-771 PWR (W8)

Optional Equipment:

ASI MN	OEM PN	Description
ASI-77-1E	649-0970-001/2	DAA-4A Dummy Antenna Weight
ASI-742	2041589-0401	Radar System Test Panel (RCT-4A)
ASI-760	2041591-0401	Radar Indicator Test Panel (PPT-4A)
ASI-169-2	2041793-0401	Radar Test Set (RST-4A)
ASI-252-2	2041593-0401	Radar Control Test Panel (COT-4A)

KDM-7060 DME Test Panel		ASI-776-1																																	
OEM Equivalent: Bendix/King MN: PN: 002-00608-0000 Manual: 006-05561-0003 Fig: 5-2		UUT: KDM-7060 Size: H: 7.00" W: 19.00" D: 12.00" Pwr: 115 VAC 400 Hz																																	
Description: The ASI-776-1 works in conjunction with a KDI-574 DME Indicator, ARINC 429 Bus Reader, DME Generator and various standard shop equipment to function test the KDM-7060. The ASI-776-1 includes a built in ARINC 568 decoder/indicator, control head and an agility control board. The ASI-776-1 is designed to test the KDM-7060 as a complete unit. If a fault is found the internal components (KDM-706A and KDA-1120) must be individually tested. The ASI-776-2 (purchased separately) provides capability to test the KDM-706A. The cables required to interface the ASI-776-1 to the KDM-7060 and the KDI-574 are included with the test panel.		Equipment Supplied: <table border="0"> <tr> <td><u>ASI MN</u></td> <td><u>OEM PN</u></td> <td><u>Description</u></td> </tr> <tr> <td>ASI-77-61A</td> <td>NPN</td> <td>Cable, ASI-776-1 to KDA-7060</td> </tr> <tr> <td>ASI-77-61B</td> <td>NPN</td> <td>Cable, ASI-776-1 to KDI-574</td> </tr> </table> Optional Equipment: <table border="0"> <tr> <td><u>ASI MN</u></td> <td><u>OEM PN</u></td> <td><u>Description</u></td> </tr> <tr> <td>ASI-182</td> <td>622-3582-001</td> <td>ARINC-521/568 Test Panel (975D-2)</td> </tr> <tr> <td>ASI-357</td> <td>NPN</td> <td>Test Panel for KDM-706</td> </tr> <tr> <td>ASI-776-2</td> <td>002-00609-0000</td> <td>Test Panel for KDM-706A</td> </tr> <tr> <td>ASI-776-3</td> <td>002-00615-0000</td> <td>Test Panel for KDM-7070</td> </tr> </table>	<u>ASI MN</u>	<u>OEM PN</u>	<u>Description</u>	ASI-77-61A	NPN	Cable, ASI-776-1 to KDA-7060	ASI-77-61B	NPN	Cable, ASI-776-1 to KDI-574	<u>ASI MN</u>	<u>OEM PN</u>	<u>Description</u>	ASI-182	622-3582-001	ARINC-521/568 Test Panel (975D-2)	ASI-357	NPN	Test Panel for KDM-706	ASI-776-2	002-00609-0000	Test Panel for KDM-706A	ASI-776-3	002-00615-0000	Test Panel for KDM-7070									
<u>ASI MN</u>	<u>OEM PN</u>	<u>Description</u>																																	
ASI-77-61A	NPN	Cable, ASI-776-1 to KDA-7060																																	
ASI-77-61B	NPN	Cable, ASI-776-1 to KDI-574																																	
<u>ASI MN</u>	<u>OEM PN</u>	<u>Description</u>																																	
ASI-182	622-3582-001	ARINC-521/568 Test Panel (975D-2)																																	
ASI-357	NPN	Test Panel for KDM-706																																	
ASI-776-2	002-00609-0000	Test Panel for KDM-706A																																	
ASI-776-3	002-00615-0000	Test Panel for KDM-7070																																	
KDM-706A DME Test Panel		ASI-776-2																																	
OEM Equivalent: Bendix/King MN: PN: 002-00609-0000 Manual: 006-05666-0009 Fig: 5-8		UUT: KDM-706A Size: H: 7.00" W: 19.00" D: 17.00" Pwr: 115 VAC 400 Hz																																	
Description: The ASI-776-2 works in conjunction with a KDI-574, KDI-5710, KFS-560A, KFS-564, ARINC 429 Bus Reader, DME Generator and various standard shop equipment to function test the KDM-706A. The ASI-776-2 is described in the KDM-706A manual as the Optional Bench Test Harness. The ASI-776-2 is a manual test panel that does not require the use of the Apple IIe Computer, Async Card or the Test Program. The cables required to interface the ASI-776-2 to the KDM-706A and the various components of the DME system are included with the test panel.		Equipment Supplied: <table border="0"> <tr> <td><u>ASI MN</u></td> <td><u>OEM PN</u></td> <td><u>Description</u></td> </tr> <tr> <td>ASI-77-62A</td> <td>NPN</td> <td>Cable, ASI-776-2 to KDM-706A</td> </tr> <tr> <td>ASI-77-62B</td> <td>NPN</td> <td>Cable, ASI-776-2 to KFS-560B</td> </tr> <tr> <td>ASI-77-62C</td> <td>NPN</td> <td>Cable, ASI-776-2 to KFS-564</td> </tr> <tr> <td>ASI-77-62D</td> <td>NPN</td> <td>Cable, ASI-776-2 to KDI-574</td> </tr> <tr> <td>ASI-77-62E</td> <td>NPN</td> <td>Cable, ASI-776-2 to KDI-5710</td> </tr> </table> Optional Equipment: <table border="0"> <tr> <td><u>ASI MN</u></td> <td><u>OEM PN</u></td> <td><u>Description</u></td> </tr> <tr> <td>ASI-200-16</td> <td>NPN</td> <td>ASI-2000 Test Adapter for KDM-706A</td> </tr> <tr> <td>ASI-357</td> <td>NPN</td> <td>Test Panel for KDM-706</td> </tr> <tr> <td>ASI-776-1</td> <td>002-00608-0000</td> <td>Test Panel for KDM-7060</td> </tr> <tr> <td>ASI-776-3</td> <td>002-00615-0000</td> <td>Test Panel for KDM-7070</td> </tr> </table>	<u>ASI MN</u>	<u>OEM PN</u>	<u>Description</u>	ASI-77-62A	NPN	Cable, ASI-776-2 to KDM-706A	ASI-77-62B	NPN	Cable, ASI-776-2 to KFS-560B	ASI-77-62C	NPN	Cable, ASI-776-2 to KFS-564	ASI-77-62D	NPN	Cable, ASI-776-2 to KDI-574	ASI-77-62E	NPN	Cable, ASI-776-2 to KDI-5710	<u>ASI MN</u>	<u>OEM PN</u>	<u>Description</u>	ASI-200-16	NPN	ASI-2000 Test Adapter for KDM-706A	ASI-357	NPN	Test Panel for KDM-706	ASI-776-1	002-00608-0000	Test Panel for KDM-7060	ASI-776-3	002-00615-0000	Test Panel for KDM-7070
<u>ASI MN</u>	<u>OEM PN</u>	<u>Description</u>																																	
ASI-77-62A	NPN	Cable, ASI-776-2 to KDM-706A																																	
ASI-77-62B	NPN	Cable, ASI-776-2 to KFS-560B																																	
ASI-77-62C	NPN	Cable, ASI-776-2 to KFS-564																																	
ASI-77-62D	NPN	Cable, ASI-776-2 to KDI-574																																	
ASI-77-62E	NPN	Cable, ASI-776-2 to KDI-5710																																	
<u>ASI MN</u>	<u>OEM PN</u>	<u>Description</u>																																	
ASI-200-16	NPN	ASI-2000 Test Adapter for KDM-706A																																	
ASI-357	NPN	Test Panel for KDM-706																																	
ASI-776-1	002-00608-0000	Test Panel for KDM-7060																																	
ASI-776-3	002-00615-0000	Test Panel for KDM-7070																																	
KDM-7070 DME Test Panel		ASI-776-3																																	
OEM Equivalent: Bendix/King MN: PN: 002-00615-0000 Manual: 006-05561-0003 Fig: 5-3		UUT: KDM-7060 Size: H: 7.00" W: 19.00" D: 12.00" Pwr: 115 VAC 400 Hz																																	
Description: The ASI-776-3 works in conjunction with a 339D-1 DME Indicator, ARINC 429 Bus Reader, DME Generator and various standard shop equipment to function test the KDM-7070. The ASI-776-3 is designed to test the KDM-7070 as a complete unit. If a fault is found the internal components (KDM-706A and KDA-1120) must be individually tested. The ASI-776-2 (purchased separately) provides capability to test the KDM-706A. The cable required to interface the ASI-776-3 to the KDM-7070 is included with the test panel.		Equipment Supplied: <table border="0"> <tr> <td><u>ASI MN</u></td> <td><u>OEM PN</u></td> <td><u>Description</u></td> </tr> <tr> <td>ASI-77-63A</td> <td>NPN</td> <td>Cable, ASI-776-3 to KDA-7070</td> </tr> </table> Optional Equipment: <table border="0"> <tr> <td><u>ASI MN</u></td> <td><u>OEM PN</u></td> <td><u>Description</u></td> </tr> <tr> <td>ASI-182</td> <td>622-3582-001</td> <td>ARINC-521/568 DME Test Panel (975D-2)</td> </tr> <tr> <td>ASI-357</td> <td>NPN</td> <td>Test Panel for KDM-706</td> </tr> <tr> <td>ASI-776-1</td> <td>002-00608-0000</td> <td>Test Panel for KDM-7060</td> </tr> <tr> <td>ASI-776-2</td> <td>002-00609-0000</td> <td>Test Panel for KDM-706A</td> </tr> </table>	<u>ASI MN</u>	<u>OEM PN</u>	<u>Description</u>	ASI-77-63A	NPN	Cable, ASI-776-3 to KDA-7070	<u>ASI MN</u>	<u>OEM PN</u>	<u>Description</u>	ASI-182	622-3582-001	ARINC-521/568 DME Test Panel (975D-2)	ASI-357	NPN	Test Panel for KDM-706	ASI-776-1	002-00608-0000	Test Panel for KDM-7060	ASI-776-2	002-00609-0000	Test Panel for KDM-706A												
<u>ASI MN</u>	<u>OEM PN</u>	<u>Description</u>																																	
ASI-77-63A	NPN	Cable, ASI-776-3 to KDA-7070																																	
<u>ASI MN</u>	<u>OEM PN</u>	<u>Description</u>																																	
ASI-182	622-3582-001	ARINC-521/568 DME Test Panel (975D-2)																																	
ASI-357	NPN	Test Panel for KDM-706																																	
ASI-776-1	002-00608-0000	Test Panel for KDM-7060																																	
ASI-776-2	002-00609-0000	Test Panel for KDM-706A																																	
KDM-7000/A/B DME Test and Pinout Panel		ASI-776-4																																	
OEM Equivalent: Bendix/King MN: PN: 696-2795-00 Manual: 006-05155-0005 Fig: 902-908		UUT: KDM-7000 / KDM-7000A / KDM-7000B Size: H: 12.25" W: 19.00" D: 12.00" Pwr: 115 VAC 400 Hz																																	
Description: The ASI-776-4 works in conjunction with a DME Indicator, DME Generator and various standard shop equipment to function test the KDM-7000/A/B. The ASI-776-4 includes the DME Test Set and the Pin Out Panel functions combined into one test panel for the KDM-7000/A/B. The DME Indicator (KDI-5710) required for proper operation of the ASI-776-4 is user supplied. The cable required to interface the ASI-776-4 to the KDM-7000/A/B is included with the test panel.		Equipment Supplied: <table border="0"> <tr> <td><u>ASI MN</u></td> <td><u>OEM PN</u></td> <td><u>Description</u></td> </tr> <tr> <td>ASI-77-64A</td> <td>NPN</td> <td>Cable, ASI-776-4 to KDM-7000/A/B</td> </tr> </table> Optional Equipment: <table border="0"> <tr> <td><u>ASI MN</u></td> <td><u>OEM PN</u></td> <td><u>Description</u></td> </tr> <tr> <td>ASI-176-1</td> <td>NPN</td> <td>Digital DME Indicator Test Set</td> </tr> <tr> <td>ASI-182</td> <td>622-3582-001</td> <td>ARINC-521/568 DME Test Set (975D-2)</td> </tr> </table>	<u>ASI MN</u>	<u>OEM PN</u>	<u>Description</u>	ASI-77-64A	NPN	Cable, ASI-776-4 to KDM-7000/A/B	<u>ASI MN</u>	<u>OEM PN</u>	<u>Description</u>	ASI-176-1	NPN	Digital DME Indicator Test Set	ASI-182	622-3582-001	ARINC-521/568 DME Test Set (975D-2)																		
<u>ASI MN</u>	<u>OEM PN</u>	<u>Description</u>																																	
ASI-77-64A	NPN	Cable, ASI-776-4 to KDM-7000/A/B																																	
<u>ASI MN</u>	<u>OEM PN</u>	<u>Description</u>																																	
ASI-176-1	NPN	Digital DME Indicator Test Set																																	
ASI-182	622-3582-001	ARINC-521/568 DME Test Set (975D-2)																																	

KLN-900 Test Panel		ASI-781
OEM Equivalent: Bendix/King MN: PN: Manual: 006-15534-0000 Fig: 902	UUT: KLN-900 Size: H: 12.25" W: 19.00" D: 8.50" Pwr: 115 VAC 400Hz / 28 VDC	Equipment Supplied: ASI MN OEM PN Description ASI-78-1A Cable, ASI-781 to KLN-900 (J9001) ASI-78-1B Cable, ASI-781 to KLN-900 (J9002) ASI-78-1C Cable, ASI-781 to KTS-143 ASI-78-1D Cable, GPS-101 to KLN-900 (J9003)
Description: The ASI-781 Test Panel works in conjunction with the KTS-143 Test Fixture and a GPS Simulator (GPS-101) to function test the KLN-900 GPS Navigation System. The required KCM-100 (071-00073-5000) configuration module must be user supplied. An optional RMI Cable (ASI-78-1E) is also available.		Optional Equipment: ASI MN OEM PN Description ASI-78-1E Cable, KTS-143 to KI-229
KFS-599A/B Test Panel		ASI-782
OEM Equivalent: Bendix/King MN: PN: Manual: 006-15634-0001 Fig: 9001-9006	UUT: KFS-599A / KFS-599B Size: H: 9.00" W: 5.00" D: 6.00" Pwr: 28 VDC	Equipment Supplied: ASI MN OEM PN Description ASI-78-2A Cable, ASI-782 to KFS-599A/B ASI-78-2B Cable, ASI-782 to KTR-909A/B
Description: The ASI-782 works in conjunction with a known good KTR-909A/B, ARINC 429 Analyzer and common shop equipment to fully test the KFS-599A/B Control Head. The cables required to interface the Test Set to the KFS-599A/B and KTR-909A/B are included with the ASI-782.		Optional Equipment: ASI MN OEM PN Description ASI-502 Control Wizard, ARINC 429 Analyzer
RDR-2000/2100 Radar System Test Set		ASI-783
OEM Equivalent: Honeywell MN: PN: Manual: 071-01519-0101 Fig: 9001 Manual: 071-01550-0101 Fig: 9001	UUT: ART-2000 / ART-2100 IN-182A / IN-842A / IN-862A Size: H: 4.00" W: 8.00" D: 6.00" Pwr: 28 VDC	Equipment Supplied: ASI MN OEM PN Description ASI-78-3A Cable, ASI-783 to IN-842A / IN-862A ASI-78-3B Cable, ASI-783 to IN-182A / IN-812A ASI-78-3C Cable, ASI-783 to ART-2000 / ART-2100
Description: The ASI-783 Radar System Test Set provides to ability to function test the RDR-2000 and RDR-2100 Weather Radar Systems. The CM2000 Configuration Module (071-00097-0100) and KPA900 Configuration Module Programmer Kit (050-03311-0000) must be purchased direct from Honeywell. The Waveguide Plate (ASI-78-3E) and the CM2000 Configuration Module can be purchased together from Honeywell by ordering the Bench Test Kit (050-03299-0000).		Optional Equipment: ASI MN OEM PN Description ASI-78-3D Cable, ART-2000/2100 40 Pin Extender Cable ASI-78-3E Waveguide Plate ASI-78-3F Cable, ASI-783 to KMD-540 with KAC501 Card ASI-78-3G Cable, ASI-783 to FlightMax750 (800-00002-010) ASI-267 7010568-901 Gyro Simulator (GSM-100) ASI-784 071-00168-0000 Test Panel for KMD-540
KMD-540 Test Set		ASI-784
OEM Equivalent: Bendix/King PN: 071-00168-0000 Manual: 006-15608-0004 Fig: 9001-9003	UUT: KMD-540 Size: H: 4.00" W: 17.00" D: 12.00" Pwr: 115 VAC 400Hz	Equipment Supplied: ASI MN OEM PN Description ASI-78-4A 200-09828-0000 Cable, ASI-784 to KMD-540 (J3001) ASI-78-4B 200-09827-0000 Cable, ASI-784 to KMD-540 (J3002) ASI-78-4C 200-09830-0000 Cable, ASI-784 to 28 VDC Power
Description: The ASI-784 Test Set works in conjunction with an ARINC 429/453 Analyzer, a Heading Simulator, and various standard shop test equipment to function test and troubleshoot the KMD-540 Multi-Function Display. The required Diagnostic Test Software (222-00471-00XX) must be purchased directly from Honeywell.		Optional Equipment: ASI MN OEM PN Description ASI-167 522-3498-000 Heading Simulator (978F-2S)
KLN Test Panel		ASI-785
OEM Equivalent: Bendix/King Manual: 006-15518-0000 Fig: 5-1 Manual: 006-15522-0000 Fig: 5-1 Manual: 006-15521-0003 Fig: 9002 Manual: 006-15599-0001 Fig: 5-1	UUT: KLN-35A / KLN-89/89A KLN-90/90A/90B / KLN-94 Size: H: 7.00" W: 19.00" D: 8.00" Pwr: 28 VDC	Equipment Supplied: ASI MN OEM PN Description ASI-78-5D Cable, ASI-785 to KTS-143 ASI-78-5E Cable, KLN to GPS Simulator
Description: The ASI-785 Test Panel works in conjunction with a KTS-143, and a GPS Simulator (GS-100 or GPS-101) to function test the KLN-35A/89/89A/90/90A/90B/94 GPS Receivers. If the Software Upgrade Tool Kit (050-02221-0000) is required it must be purchased directly from Honeywell.		Optional Equipment: ASI MN OEM PN Description ASI-78-5A Cable, ASI-785 to KLN-89/89A / KLN-94 ASI-78-5B Cable, ASI-785 to KLN-90/90A/90B ASI-78-5C Cable, ASI-785 to KLN-35A ASI-78-5F 155-02794-0001 Cable, ASI-785 to PC Serial Port ASI-78-5G Cable, ASI-785 to KI-229 RMI ASI-165 622-5330-001 Synchro/Resolver Source (CSS-10)
RDS Radar System Test Set		ASI-786
OEM Equivalent: Bendix/King Manual: 006-05997-0003 Fig: 5-1 Manual: 006-05913-0003 Fig: 6-1 Manual: 006-05998-0002 Fig: 5-2 Manual: 006-05996-0008 Fig: 5-1	UUT: RDS-81: RS-811A / IN-812A RDS-82: RS-181A / IN-182A RDS-84: RS-841A / IN-842A RDS-86: RS-861A / IN-862A/B / CN-863A Size: H: 4.00" W: 8.00" D: 6.00" Pwr: 28 VDC	Optional Equipment: ASI MN OEM PN Description ASI-78-6A1 Cable, ASI-786 to RDS-81 / RDS-82 RT ASI-78-6A2 Cable, ASI-786 to RDS-81 / RDS-82 IND ASI-78-6B1 Cable, ASI-786 to RDS-84 / RDS-86 RT ASI-78-6B2 Cable, ASI-786 to RDS-84 / RDS-86 IND ASI-78-6B3 Cable, IN-862B IND to CN-863A CTL ASI-78-6C Cable, ASI-786 to KMD-540 with KAC501 Card ASI-78-6D Cable, ASI-786 to FlightMax750 (800-00002-010)
Description: The ASI-786 Radar System Test Set works in conjunction with a radar generator and other standard shop equipment to provide the ability to test the RDS-81/82/84/86 Weather Radar Systems. Optional cables required for operation must be purchased separately based on the radar system being tested.		

Direction Finder Group Test Set		ASI-789																														
OEM Rockwell Collins MN: AN/ARM-102 PN: 522-4545-001 Manual: 16-30ARM102-1	UUT: AN/ARA-50: AS-909/ARA-50 AM-3624/ARA-50, MT-195/ARA-50 Pwr: 28 VDC / 115 VAC 400 Hz	Equipment Supplied: <table border="1"> <thead> <tr> <th>ASI MN</th> <th>OEM PN</th> <th>Description</th> </tr> </thead> <tbody> <tr> <td>ASI-789-1</td> <td>522-4817-001</td> <td>Test Set (TS-2544/ARM-102)</td> </tr> <tr> <td>ASI-789-2</td> <td>522-4818-001</td> <td>Test Mount (MT-3726/ARM-102)</td> </tr> <tr> <td>ASI-78-9A</td> <td>522-4855-001</td> <td>Cable (W1/ARM-102)</td> </tr> <tr> <td>ASI-78-9B</td> <td>522-4856-001</td> <td>Cable (W2/ARM-102)</td> </tr> <tr> <td>ASI-78-9C</td> <td>522-4857-001</td> <td>Cable (W3/ARM-102)</td> </tr> <tr> <td>ASI-78-9D</td> <td>522-4939-001</td> <td>Cable (W4/ARM-102)</td> </tr> </tbody> </table>	ASI MN	OEM PN	Description	ASI-789-1	522-4817-001	Test Set (TS-2544/ARM-102)	ASI-789-2	522-4818-001	Test Mount (MT-3726/ARM-102)	ASI-78-9A	522-4855-001	Cable (W1/ARM-102)	ASI-78-9B	522-4856-001	Cable (W2/ARM-102)	ASI-78-9C	522-4857-001	Cable (W3/ARM-102)	ASI-78-9D	522-4939-001	Cable (W4/ARM-102)									
ASI MN	OEM PN	Description																														
ASI-789-1	522-4817-001	Test Set (TS-2544/ARM-102)																														
ASI-789-2	522-4818-001	Test Mount (MT-3726/ARM-102)																														
ASI-78-9A	522-4855-001	Cable (W1/ARM-102)																														
ASI-78-9B	522-4856-001	Cable (W2/ARM-102)																														
ASI-78-9C	522-4857-001	Cable (W3/ARM-102)																														
ASI-78-9D	522-4939-001	Cable (W4/ARM-102)																														
<p>Description:</p> <p>The ASI-789 Direction Finder Group Test Set is used for testing and troubleshooting the AN/ARA-50 Direction Finder Group.</p> <p>The ASI-789 includes the ASI-789-1 Test Set, ASI-789-2 Test Mount and associated cables. See below or specific information on these items.</p>		Optional Equipment: <table border="1"> <thead> <tr> <th>ASI MN</th> <th>OEM PN</th> <th>Description</th> </tr> </thead> <tbody> <tr> <td>ASI-789-3</td> <td>622-2182-001</td> <td>Test Adapter, ASI-789 to DF-301E</td> </tr> </tbody> </table>	ASI MN	OEM PN	Description	ASI-789-3	622-2182-001	Test Adapter, ASI-789 to DF-301E																								
ASI MN	OEM PN	Description																														
ASI-789-3	622-2182-001	Test Adapter, ASI-789 to DF-301E																														
Test Set		ASI-789-1																														
OEM: Rockwell Collins MN: TS-2544/ARM-102 PN: 522-4817-001 Manual: 16-30ARM102-1	UUT: AN/ARA-50: AS-909/ARA-50 AM-3624/ARA-50, MT-195/ARA-50 Pwr: 28 VDC / 115 VAC 400 Hz	Equipment Supplied: <table border="1"> <thead> <tr> <th>MN</th> <th>OEM PN</th> <th>Description</th> </tr> </thead> <tbody> <tr> <td>200101</td> <td>482-0058-010</td> <td>Bearing Indicator (Pre-Installed)</td> </tr> </tbody> </table>	MN	OEM PN	Description	200101	482-0058-010	Bearing Indicator (Pre-Installed)																								
MN	OEM PN	Description																														
200101	482-0058-010	Bearing Indicator (Pre-Installed)																														
<p>Description:</p> <p>The ASI-789-1 Test Set is used for testing and troubleshooting the AN/ARA-50 Direction Finder Group. The Test Set provides capabilities for functional control and indication required for monitoring the relative bearing of the received signal to the direction finder antenna. The ASI-789-1 includes an pre-installed Bearing Indicator (200101 / 482-0058-010) or equivalent.</p> <p>The ASI-789-1 works in conjunction with the ASI-789-2 Test Mount and associated cables during testing of the AN/ARA-50 Direction Finder Group.</p>		Optional Equipment: <table border="1"> <thead> <tr> <th>ASI MN</th> <th>OEM PN</th> <th>Description</th> </tr> </thead> <tbody> <tr> <td>ASI-789-2</td> <td>522-4818-001</td> <td>Test Mount (MT-3726/ARM-102)</td> </tr> <tr> <td>ASI-789-3</td> <td>622-2182-001</td> <td>Test Adapter, ASI-789 to DF-301E</td> </tr> </tbody> </table>	ASI MN	OEM PN	Description	ASI-789-2	522-4818-001	Test Mount (MT-3726/ARM-102)	ASI-789-3	622-2182-001	Test Adapter, ASI-789 to DF-301E																					
ASI MN	OEM PN	Description																														
ASI-789-2	522-4818-001	Test Mount (MT-3726/ARM-102)																														
ASI-789-3	622-2182-001	Test Adapter, ASI-789 to DF-301E																														
Test Mount		ASI-789-2																														
OEM: Rockwell Collins MN: MT-3726/ARM-102 PN: 522-4818-001 Manual: 16-30ARM102-1	UUT: AN/ARA-50: AS-909/ARA-50 AM-3624/ARA-50, MT-195/ARA-50 Pwr: 28 VDC / 115 VAC 400 Hz	Equipment Supplied: <table border="1"> <thead> <tr> <th>ASI MN</th> <th>OEM PN</th> <th>Description</th> </tr> </thead> <tbody> <tr> <td>ASI-78-9A</td> <td>522-4855-001</td> <td>Cable (W1/ARM-102)</td> </tr> <tr> <td>ASI-78-9B</td> <td>522-4856-001</td> <td>Cable (W2/ARM-102)</td> </tr> <tr> <td>ASI-78-9C</td> <td>522-4857-001</td> <td>Cable (W3/ARM-102)</td> </tr> <tr> <td>ASI-78-9D</td> <td>522-4939-001</td> <td>Cable (W4/ARM-102)</td> </tr> </tbody> </table>	ASI MN	OEM PN	Description	ASI-78-9A	522-4855-001	Cable (W1/ARM-102)	ASI-78-9B	522-4856-001	Cable (W2/ARM-102)	ASI-78-9C	522-4857-001	Cable (W3/ARM-102)	ASI-78-9D	522-4939-001	Cable (W4/ARM-102)															
ASI MN	OEM PN	Description																														
ASI-78-9A	522-4855-001	Cable (W1/ARM-102)																														
ASI-78-9B	522-4856-001	Cable (W2/ARM-102)																														
ASI-78-9C	522-4857-001	Cable (W3/ARM-102)																														
ASI-78-9D	522-4939-001	Cable (W4/ARM-102)																														
<p>Description:</p> <p>The ASI-789-2 Test Mount is used for testing and troubleshooting the AN/ARA-50 Direction Finder Group. The Test Mount is a mechanical assembly that secures the AS-909/ARA-48 antenna and AN-3624/ARA-50 amplifier to the bench during testing. The ASI-789-2 includes the four cables required to test interconnection.</p> <p>The ASI-789-2 works in conjunction with the ASI-789-1 during testing of the AN/ARA-50 Direction Finder Group.</p>		Optional Equipment: <table border="1"> <thead> <tr> <th>ASI MN</th> <th>OEM PN</th> <th>Description</th> </tr> </thead> <tbody> <tr> <td>ASI-789-1</td> <td>522-4817-001</td> <td>Test Set (TS-2544/ARM-102)</td> </tr> <tr> <td>ASI-789-3</td> <td>622-2182-001</td> <td>Test Adapter, ASI-789 to DF-301E</td> </tr> </tbody> </table>	ASI MN	OEM PN	Description	ASI-789-1	522-4817-001	Test Set (TS-2544/ARM-102)	ASI-789-3	622-2182-001	Test Adapter, ASI-789 to DF-301E																					
ASI MN	OEM PN	Description																														
ASI-789-1	522-4817-001	Test Set (TS-2544/ARM-102)																														
ASI-789-3	622-2182-001	Test Adapter, ASI-789 to DF-301E																														
Direction Finder Test Set		ASI-790																														
OEM: Rockwell Collins MN: 970V-1 PN: 622-3029-001 Manual: 523-0770551	UUT: DF-301E OA-8697/ARD Pwr: 28 VDC / 115/220 VAC 50-60 Hz	Equipment Supplied: <table border="1"> <thead> <tr> <th>ASI MN</th> <th>OEM PN</th> <th>Description</th> </tr> </thead> <tbody> <tr> <td>ASI-79-0A</td> <td>630-1292-001</td> <td>Cable W1</td> </tr> <tr> <td>ASI-79-0B</td> <td>630-1293-001</td> <td>Cable W2</td> </tr> <tr> <td>ASI-79-0C</td> <td>630-1294-001</td> <td>Cable W3</td> </tr> <tr> <td>ASI-79-0D</td> <td>630-1295-001</td> <td>Cable W4</td> </tr> <tr> <td>ASI-79-0E</td> <td>630-1296-001</td> <td>Cable W5</td> </tr> <tr> <td>ASI-79-0F</td> <td>630-1297-001</td> <td>Cable W6</td> </tr> <tr> <td>ASI-79-0G</td> <td>630-1524-002</td> <td>Cable W7</td> </tr> <tr> <td>ASI-79-0H</td> <td>630-1524-003</td> <td>Cable W8</td> </tr> <tr> <td>ASI-79-0J</td> <td>630-1298-001</td> <td>Cable W9</td> </tr> </tbody> </table>	ASI MN	OEM PN	Description	ASI-79-0A	630-1292-001	Cable W1	ASI-79-0B	630-1293-001	Cable W2	ASI-79-0C	630-1294-001	Cable W3	ASI-79-0D	630-1295-001	Cable W4	ASI-79-0E	630-1296-001	Cable W5	ASI-79-0F	630-1297-001	Cable W6	ASI-79-0G	630-1524-002	Cable W7	ASI-79-0H	630-1524-003	Cable W8	ASI-79-0J	630-1298-001	Cable W9
ASI MN	OEM PN	Description																														
ASI-79-0A	630-1292-001	Cable W1																														
ASI-79-0B	630-1293-001	Cable W2																														
ASI-79-0C	630-1294-001	Cable W3																														
ASI-79-0D	630-1295-001	Cable W4																														
ASI-79-0E	630-1296-001	Cable W5																														
ASI-79-0F	630-1297-001	Cable W6																														
ASI-79-0G	630-1524-002	Cable W7																														
ASI-79-0H	630-1524-003	Cable W8																														
ASI-79-0J	630-1298-001	Cable W9																														
<p>Description:</p> <p>The ASI-790 Direction Finder Test Set works in conjunction with standard bench equipment and an appropriate UHF radio set to test and troubleshoot the DF-301E / OA-8697/ARD Direction Finder. The ASI-790 will test the accuracy and sensitivity of the direction finder throughout the 100-400 MHz range.</p> <p>The Test Set includes the Control Panel, Antenna Stand and nine cables that provide interconnection between the test set, unit under test, and the required bench equipment.</p>		Optional Equipment: <table border="1"> <thead> <tr> <th>ASI MN</th> <th>OEM PN</th> <th>Description</th> </tr> </thead> <tbody> </tbody> </table>	ASI MN	OEM PN	Description																											
ASI MN	OEM PN	Description																														
ADF Antenna Simulator		ASI-798																														
OEM: Bendix/King MN: KTS156 PN: 071-5038-00 Manual: 006-05535-0003	UUT: KA44 / KA44B KR87 / KDF806 Pwr: +14 VDC / +28 VDC	Equipment Supplied: <table border="1"> <thead> <tr> <th>ASI MN</th> <th>OEM PN</th> <th>Description</th> </tr> </thead> <tbody> <tr> <td>ASI-798-1</td> <td>200-6448-01</td> <td>Test Adapter (KTA156)</td> </tr> <tr> <td>ASI-798-2</td> <td>200-2748-01</td> <td>Antenna Amplifier Module</td> </tr> </tbody> </table>	ASI MN	OEM PN	Description	ASI-798-1	200-6448-01	Test Adapter (KTA156)	ASI-798-2	200-2748-01	Antenna Amplifier Module																					
ASI MN	OEM PN	Description																														
ASI-798-1	200-6448-01	Test Adapter (KTA156)																														
ASI-798-2	200-2748-01	Antenna Amplifier Module																														
<p>Description:</p> <p>The ASI-798 ADF Antenna Simulator is used to test the KR87, KDF806 and the Electronics Portion of the KA44/44B antennas.</p> <p>The ASI-798 simulates signals picked up by the KA44/44B and is used to align the Electronics Portion of the ADF antenna with or without an ADF Receiver. The ASI-798 may also be used to test the ADF system by providing signals with bearing information.</p> <p>The ASI-798 includes the Test Adapter (ASI-798-1) and Antenna Amplifier Module (ASI-798-2). The cables required to test the KR87 and KDF806 are listed under optional equipment.</p>		Optional Equipment: <table border="1"> <thead> <tr> <th>ASI MN</th> <th>OEM PN</th> <th>Description</th> </tr> </thead> <tbody> <tr> <td>ASI-79-8A</td> <td>200-2708-00</td> <td>Cable, ASI-798 to KR87</td> </tr> <tr> <td>ASI-79-8B</td> <td>200-2991-00</td> <td>Cable, ASI-798 to KDF806</td> </tr> <tr> <td>ASI-79-8C</td> <td>155-2125-00</td> <td>Cable, 10 Pin Jumper</td> </tr> <tr> <td>ASI-79-8D</td> <td>155-2125-01</td> <td>Cable, 2 Pin Jumper</td> </tr> <tr> <td>ASI-79-8E</td> <td>155-2125-02</td> <td>Cable, 9 Pin Jumper</td> </tr> </tbody> </table>	ASI MN	OEM PN	Description	ASI-79-8A	200-2708-00	Cable, ASI-798 to KR87	ASI-79-8B	200-2991-00	Cable, ASI-798 to KDF806	ASI-79-8C	155-2125-00	Cable, 10 Pin Jumper	ASI-79-8D	155-2125-01	Cable, 2 Pin Jumper	ASI-79-8E	155-2125-02	Cable, 9 Pin Jumper												
ASI MN	OEM PN	Description																														
ASI-79-8A	200-2708-00	Cable, ASI-798 to KR87																														
ASI-79-8B	200-2991-00	Cable, ASI-798 to KDF806																														
ASI-79-8C	155-2125-00	Cable, 10 Pin Jumper																														
ASI-79-8D	155-2125-01	Cable, 2 Pin Jumper																														
ASI-79-8E	155-2125-02	Cable, 9 Pin Jumper																														

DME Test Panel		ASI-801	
OEM Equivalent: Bendix MN: DMT-37A PN: 2041594-3701 Manual: IB1137AT Figure: 1	UUT: DMA-37A Size: H: 10.50" W: 19.00" D: 17.00" Pwr: 115/230 VAC 50-60 Hz & 115 VAC 400Hz	Equipment Supplied: ASI MN OEM PN Description ASI-80-1A 2040065-0501 Cable, ASI-801 to DMA-37A (W101) ASI-80-XA 44127-0001 Power Cord, 115 VAC 60 Hz ASI-80-XB 2040020-0502 Power Cord, 115 VAC 400 Hz	
Description: The ASI-801 DME Test Panel facilitates testing, alignment, and troubleshooting of the Bendix DMA-37A DME Interrogator. The ASI-801 front panel provides keyboards, controls, and displays required to manually enter and monitor test functions for checking the UUT. The Test Panel has the capability to interface and operate under control of automatic test equipment (ATE) through an IEEE-488 port located on the rear of the test panel. This port also enables the ASI-801 to output test data on a standard parallel printer (requires optional ASI-80-XD cable). The ASI-801 includes an interconnect cable (ASI-80-1A) for the DMA-37A.		Optional Equipment: ASI MN OEM PN Description ASI-80-XC1 2040410-0501 Wrap-Around Test Connector ASI-80-XD NPN Printer Cable, IEEE-488 ASI-80-XE 2039835-0501 Test Set Module Extender Board ASI-80-XF 2040179-0501 Test Set Module Extender Cable	
Radio Altimeter Test Panel		ASI-802	
OEM Equivalent: Bendix MN: ALT-52A PN: 2041475-5201 Manual: IB1152AT Figure: 1	UUT: ALA-52A Size: H: 10.50" W: 19.00" D: 17.00" Pwr: 115/230 VAC 50-60 Hz & 115 VAC 400Hz	Equipment Supplied: ASI MN OEM PN Description ASI-80-2A 2040070-0501 Cable, ASI-802 to ALA-52A (W101) ASI-80-XA 44127-0001 Power Cord, 115 VAC 60 Hz ASI-80-XB 2040020-0502 Power Cord, 115 VAC 400 Hz	
Description: The ASI-802 Radio Altimeter Test Panel facilitates testing, alignment, and troubleshooting of the Bendix ALA-52A Radio Altimeter. The ASI-802 front panel provides keyboards, controls, and displays required to manually enter and monitor test functions for checking the UUT. The Test Panel has the capability to interface and operate under control of automatic test equipment (ATE) through an IEEE-488 port located on the rear of the test panel. This port also enables the ASI-802 to output test data on a standard parallel printer (requires optional ASI-80-XD cable). The ASI-802 includes an interconnect cable (ASI-80-2A) for the ALA-52A.		Optional Equipment: ASI MN OEM PN Description ASI-80-XC1 2040410-0501 Wrap-Around Test Connector ASI-80-XD NPN Printer Cable, IEEE-488 ASI-80-XE 2039835-0501 Test Set Module Extender Board ASI-80-XF 2040179-0501 Test Set Module Extender Cable	
VHF COM Test Panel		ASI-803	
OEM Equivalent: Bendix MN: RTT-44A PN: 2041524-4401 Manual: IB1144AT Figure: 1	UUT: RTA-44A / RTA-83A / RTA-83B Size: H: 10.50" W: 19.00" D: 17.00" Pwr: 115/230 VAC 50-60 Hz & 28 VDC	Equipment Supplied: ASI MN OEM PN Description ASI-80-3A 2040282-0504 Cable, ASI-803 to RTA-44A / RTA-83B (W101) ASI-80-XA 44127-0001 Power Cord, 115 VAC 60 Hz ASI-80-XG 2040692-0501 Power Cord, 28 VDC	
Description: The ASI-803 VHF COM Test Panel facilitates testing, alignment, and troubleshooting of the Bendix RTT-44A and RTA-83B VHF Transceivers. The ASI-803 provides keyboards, controls, and displays required to manually enter and monitor test functions for checking the UUT. The Test Panel has the capability to interface and operate under control of automatic test equipment (ATE) through an IEEE-488 port located on the rear of the test panel. This port also enables the ASI-803 to output test data on a standard parallel printer (requires optional ASI-80-XD cable). The ASI-803 includes an interconnect cable (ASI-80-3A) for the RTA-44A / RTA-83B.		Optional Equipment: ASI MN OEM PN Description ASI-80-3B 747-0446-001 Cable, ASI-803 to RTA-83A ASI-80-XC1 2040410-0501 Wrap-Around Test Connector ASI-80-XD NPN Printer Cable, IEEE-488 ASI-80-XE 2039835-0501 Test Set Module Extender Board ASI-80-XF 2040179-0501 Test Set Module Extender Cable ASI-803-1 303-0005-001 2X5 Tuning Panel for RTA-83A	
ADF Test Panel		ASI-804	
OEM Equivalent: Bendix MN: DFT-75A PN: 2041520-7501 Manual: IB1135AT Figure: 1	UUT: DFA-75A Size: H: 10.50" W: 19.00" D: 17.00" Pwr: 115/230 VAC 50-60 Hz & 115 VAC 400Hz	Equipment Supplied: ASI MN OEM PN Description ASI-80-4A 2040300-0501 Cable, ASI-804 to DFA-75A (W101) ASI-80-XA 44127-0001 Power Cord, 115 VAC 60 Hz ASI-80-XB 2040020-0502 Power Cord, 115 VAC 400 Hz	
Description: The ASI-804 ADF Test Panel facilitates testing, alignment, and troubleshooting of the Bendix DFA-75A ADF Receiver. The ASI-804 front panel provides keyboards, controls, and displays required to manually enter and monitor test functions for checking the UUT. The Test Panel has the capability to interface and operate under control of automatic test equipment (ATE) through an IEEE-488 port located on the rear of the test panel. This port also enables the ASI-804 to output test data on a standard parallel printer (requires optional ASI-80-XD cable). The ASI-804 includes an interconnect cable (ASI-80-4A) for the DFA-75A. The Optional ASI-804-1 and ASI-804-2 are required to test the ANA-75B ADF Ant.		Optional Equipment: ASI MN OEM PN Description ASI-80-XC1 2040410-0501 Wrap-Around Test Connector ASI-80-XC2 2040903-0501 Wrap-Around Test Connector ASI-80-XD NPN Printer Cable, IEEE-488 ASI-80-XE 2039835-0501 Test Set Module Extender Board ASI-80-XF 2040179-0501 Test Set Module Extender Cable ASI-804-1 2041597-7501 ANA-75B ADF Antenna Test Set (DFT-75B) ASI-804-2 2040156-0501 ANA-75B ADF Antenna Holding Fixture ASI-804-3 NPN ANA-75B ADF Antenna Simulator Test Set	
NAV Test Panel		ASI-805	
OEM Equivalent: Bendix MN: RNT-30A PN: 2041634-3003 Manual: IB1130AT Figure: 1	UUT: RIA-35A / RIA-35B / RVA-36A Size: H: 10.50" W: 19.00" D: 17.00" Pwr: 115/230 VAC 50-60 Hz & 115 VAC 400Hz	Equipment Supplied: ASI MN OEM PN Description ASI-80-5A 2040085-0501 Cable, ASI-805 to RIA-35A / RIA-35B (W101) ASI-80-5B 2041779-0501 Cable, ASI-805 to RVA-36A (W102) ASI-80-XA 44127-0001 Power Cord, 115 VAC 60 Hz ASI-80-XB 2040020-0502 Power Cord, 115 VAC 400 Hz	
Description: The ASI-805 NAV Test Panel facilitates testing, alignment, and troubleshooting of the Bendix RIA-35A, RIA-35B, and RVA-36A NAV Receivers. The ASI-805 front panel provides keyboards, controls, and displays required to manually enter and monitor test functions for checking the UUT. The Test Panel has the capability to interface and operate under control of automatic test equipment (ATE) through an IEEE-488 port located on the rear of the test panel. This port also enables the ASI-805 to output test data on a standard parallel printer (requires optional ASI-80-XD cable). The ASI-805 includes interconnect cables for the RIA-35A / RIA-35B (ASI-80-5A) and RVA-36A (ASI-80-5B). The ASI-805-1 includes only the RIA-35/35B (ASI-80-5A) Cable. The ASI-805-2 includes only the RVA-36A (ASI-80-5B) Cable.		Optional Equipment: ASI MN OEM PN Description ASI-80-XC1 2040410-0501 Wrap-Around Test Connector ASI-80-XD NPN Printer Cable, IEEE-488 ASI-80-XE 2039835-0501 Test Set Module Extender Board ASI-80-XF 2040179-0501 Test Set Module Extender Cable ASI-805-1 2041634-3001 Test Set, ASI-805 with ASI-80-5A (W101) only ASI-805-2 2041634-3002 Test Set, ASI-805 with ASI-80-5B (W102) only	

Series III / FliteLine Test System		ASI-810		
OEM Equivalent: Bendix/King MN: 92N-2 PN: 01-0215-00 Manual: 06-0215-00	UUT: Series III / FliteLine Avionics Systems Size: H: 22.75" W: 19.00" D: 10.00" Pwr: 28 VDC / 26 VAC 400 Hz	Equipment Supplied:		
Description: The ASI-810 performs functional testing of the Series III and FliteLine Avionics Systems. This includes the VCS-40A/40C VHF COMM System, VNS-41A NAV System, DFS-43A ADF System, DMS-44A DME System, TRS-42A Transponder System, and FliteLine ADF/COMM/DME/NAV Systems. The ASI-810 includes the ASI-810-1, ASI-810-2, ASI-810-3 Test Panels and associated cables. See below or specific information on each Test Panel.		ASI MN	OEM PN	Description
		ASI-810-1	01-0216-00	ADF System Test Panel (92AF-1)
		ASI-810-2	01-0217-00	COMM / NAV System Test Panel (92CN-1)
		ASI-810-3	01-0218-00	DME / Transponder System Test Panel (92XD-1)
		ASI-81-01A	55-0215-15	Cable, ASI-810-1 to DF-431B / AT-434A
		ASI-81-02A	55-0215-11	Cable, ASI-810-2 to VC-401B / CVC-151
		ASI-81-02B	55-0215-12	Cable, ASI-810-2 to VN-411B / CVN-251
		ASI-81-02C	55-0215-06	Cable, HSI Substitution Plug
		ASI-81-03A	55-0215-13	Cable, ASI-810-3 to TR-421B
		ASI-81-03B	55-0215-14	Cable, ASI-810-3 to DM-441B / CDM-451
Series III / FliteLine ADF System Test Panel		ASI-810-1		
OEM Equivalent: Bendix/King MN: 92AF-1 PN: 01-0216-00 Manual: 06-0215-00	UUT: DFS-43A: DF-431B / CD-432B / AT-434A FliteLine: DF-431B / CDF-552 / AT-434A Size: H: 5.25" W: 19.00" D: 10.00" Pwr: 28 VDC / 26 VAC 400 Hz	Equipment Supplied:		
Description: The ASI-810-1 tests the DFS-43A ADF System (DF-431B / CD-432B / AT-434A) and FliteLine ADF System (DF-431B / CDF-552 / AT-434A). The Test Panel provides switching, monitoring, test points, and interconnection required to test the ADF System. A known good (user supplied) CDU must be installed in the test panel for proper operation. The ASI-810-1 is also capable of testing the DFS-43 ADF System (DF-431A / CD-432A / AT-434A). However the optional ASI-81-01C cable is required in order to test this older system. Testing of the AT-434A Antenna requires the ASI-81-01B Switch Box. Since the ASI-810-1 tests the components as a complete system, a known good system (Receiver, CDU, and Antenna) is required in order to test all of the individual components.		ASI MN	OEM PN	Description
		ASI-81-01A	55-0215-15	Cable, ASI-810-1 to DF-431B / AT-434A
		Optional Equipment:		
		ASI MN	OEM PN	Description
		ASI-81-01B	NPN	Switch Box, AT-434A
		ASI-81-01C	55-0215-05	Cable, ASI-810-1 to DF-431A / AT-434A
		ASI-81-01D	NPN	Isolation Transformer
		ASI-81-01E	005-02101-0070	Test PROM for DF-431B
		ASI-167	522-3498-000	Heading Simulator (978F-2S)
		User Supplied CDU / ANT Requirements:		
		LRU	CDU Required for Testing LRU	ANT Required for Testing LRU
		DF-431B	CD-432B or CDF-552	AT-434A
Series III / FliteLine COM / NAV System Test Panel		ASI-810-2		
OEM Equivalent: Bendix/King MN: 92CN-1 PN: 01-0217-00 Manual: 06-0215-00	UUT: VCS-40A: VC-401B / CD-402B VCS-40C: VC-401C / CD-402C VNS-41A: VN-411B / CD-412B / CD-413B FliteLine COM: CVC-151 / CVC-152 FliteLine NAV: CVN-251 / CVN-252 Size: H: 8.75" W: 19.00" D: 10.00" Pwr: 28 VDC / 26 VAC 400 Hz	Equipment Supplied:		
Description: The ASI-810-2 tests the VCS-40A VHF COM System (VC-401B / CD-402B), VCS-40C VHF COM System (VC-401C / CD-402C), VNS-41A NAV System (VN-411B / CD-412B / CD-413B), FliteLine COM System (CVC-151 / CVC-152), and FliteLine NAV System (CVN-251 / CVN-252). The Test Set provides switching, monitoring, test points, and interconnection required for testing. Known good (user supplied) CDU's (COM and NAV) must be installed in the test panel for proper operation. The ASI-810-2 is also capable of testing the VCS-40 COM System (VC-401A / CD-402A) and VNS-41 NAV System (VN-411A / CD-412A). However optional cables (ASI-81-02F / ASI-81-02G) are required in order to test these systems. Since the ASI-810-2 tests the components as a complete system, a known good system (Receiver and CDU) is required in order to test the individual components.		ASI MN	OEM PN	Description
		ASI-81-02A	55-0215-11	Cable, ASI-810-2 to VC-401B / CVC-151
		ASI-81-02B	55-0215-12	Cable, ASI-810-2 to VN-411B / CVN-251 / KI-227
		ASI-81-02C	55-0215-06	Cable, HSI Substitution Plug
		Optional Equipment:		
		ASI MN	OEM PN	Description
		ASI-81-02D	NPN	Cable, ASI-810-2 to KI-206
		ASI-81-02E1	NPN	High-Impedance Detector Probe for VC-401()
		ASI-81-02E2	NPN	High-Impedance Detector Probe for VN-411()
		ASI-81-02E3	NPN	Linear Detector for VC-401()
		ASI-81-02F	55-0215-01	Cable, ASI-810-2 to VC-401A
		ASI-81-02G	55-0215-02	Cable, ASI-810-2 to VN-411A / KI-227
		User Supplied CDU Requirements:		
		LRU	CDU Required for Testing LRU	
		VC-401B	CD-402B, CD-402C, or CVC-152	
		VC-401C	CD-402C or CVC-152	
		CVC-151	CD-402C or CVC-152	
		VN-411B	CD-412B, CD-413B, or CVN-252	
		CVN-251	CD-412B, CD-413B, or CVN-252	
Series III / FliteLine DME / Transponder System Test Panel		ASI-810-3		
OEM Equivalent: Bendix/King MN: 92XD-1 PN: 01-0218-00 Manual: 06-0215-00	UUT: DMS-44A: DM-441B / SD-442B TRS-42A: TR-421B / CD-422B FliteLine DME: CDM-451 / SD-442B Size: H: 8.75" W: 19.00" D: 10.00" Pwr: 28 VDC / 26 VAC 400 Hz	Equipment Supplied:		
Description: The ASI-810-3 tests the DMS-44A DME System (DM-441B / SD-442B), FliteLine DME System (CDM-451 / SD-442B), and TRS-42A Transponder System (TR-421B / CD-422B). The Test Panel provides switching, monitoring, test points, and interconnection required for testing. Known good (user supplied) CDU's (DME and Transponder) must be installed in the test panel for proper operation. The ASI-810-3 is also capable of testing the DMS-44 DME System (DM-441A / SD-442A) and TRS-42 Transponder System (TR-421A / CD-422A). However optional cables (ASI-81-03C / ASI-81-03D) are required in order to test these older systems. Since the ASI-810-3 tests the components as a complete system, a known good system (Receiver and CDU) is required in order to test the individual components.		ASI MN	OEM PN	Description
		ASI-81-03A	55-0215-13	Cable, ASI-810-3 to TR-421B
		ASI-81-03B	55-0215-14	Cable, ASI-810-3 to DM-441B / CDM-451
		Optional Equipment:		
		ASI MN	OEM PN	Description
		ASI-81-03C	55-0215-03	Cable, ASI-810-3 to TR-421A
		ASI-81-03D	55-0215-04	Cable, ASI-810-3 to DM-441A
		User Supplied CDU Requirements:		
		LRU	CDU Required for Testing LRU	
		DM-441B	SD-442B	
		CDM-451	SD-442B	
		TR-421B	CD-422B	

Tailwind 300/500/550 Test Equipment

ASI

SSP Breakout Box

ASI-812-1

OEM Equivalent:

OEM: Rockwell Collins
 Model Number:
 Part Number:
 Manual:
 Manual Figure:

Units Tested:

Tailwind 500/550: ACU, SSP, GEM, FMU

Specifications:

Height: 10.00" Width: 8.00" Depth: 2.00"
 Power Requirements: From UUT

This unit is manufactured to replace the OEM MN, PN, and/or manual figure listed in Form, Fit, and Function.

Description:

The ASI-812-1 SSP Breakout Box (BOB) is actually two breakout boxes in one. The first section is used to help verify or troubleshoot the System Signal Processor (SSP) and the Antenna Control Unit (ACU) of a Rockwell Collins Tailwind TV aircraft installation. The second section is used to help verify or troubleshoot the Gimbal Electronics Module (GEM) or the Fuselage Mounted Unit (FMU). The ASI-812-1 BOB provides breakout capability of the aircraft LRU interface signals to facilitate checking, testing, and injecting signals. The Aircraft harness is disconnected from the LRU and reconnected to the BOB connector extension cable. A second extension cable connects the BOB to the LRU.

Additional cables that may be required during testing are listed in the optional equipment section below.

Equipment Supplied:

ASI MN	OEM PN	Description
ASI-81-21A		Cable 1, ASI-812-1 BOB J7 to Aircraft
ASI-81-21B		Cable 2, ASI-812-1 BOB J6 to LRU
ASI-81-21C		Cable 3, ASI-812-1 BOB J9 to LRU
ASI-81-21D		Cable 4, ASI-812-1 BOB J8 to Aircraft

Optional Equipment:

ASI MN	OEM PN	Description
ASI-812-2		Cable Kit (Includes 3 cables listed below):
ASI-81-22A		Cable, RS-422 Input
ASI-81-22B		Cable, RS-485 Input
ASI-81-22C		Cable, ARINC 429 Input

RDU Breakout Box

ASI-931101-100-1

OEM Equivalent:

OEM: Rockwell Collins
 Model Number:
 Part Number: 931101-100-1
 Manual:
 Manual Figure:

Units Tested:

Tailwind 300, 500/550: RDU

Specifications:

Height: 13.00" Width: 21.00" Depth: 7.00"
 Power Requirements: From UUT

This unit is manufactured to replace the OEM MN, PN, and/or manual figure listed in Form, Fit, and Function.

Description:

The ASI-931101-100-1 Breakout Box (BOB) is used to verify and troubleshoot the Receiver Decoder Unit (RDU) of a Rockwell Collins Tailwind TV aircraft installation. The breakout box is supplied in a suitcase with two RDU interconnect cables. The BOB provides breakout capability of the aircraft RDU interface signals to facilitate checking, testing, and injecting signals. The RDU is removed from the aircraft RDU tray, then a cable (ASI-930412-100-1) is connected from the RDU tray to the BOB. Another cable (ASI-931412-101-1) connects the BOB to the removed RDU.

Additional cables that may be required during testing are listed in the optional equipment section below.

Equipment Supplied:

ASI MN	OEM PN	Description
ASI-930412-100-1	930412-100-1	Cable, Aircraft RDU Tray to BOB (10')
ASI-930412-101-1	930412-101-1	Cable, Bob to RDU (5')

Optional Equipment:

ASI MN	OEM PN	Description
ASI-920032	920032	Cable, Antenna Adapter
ASI-931402	931402	Cable, ANT/DAU
ASI-931407-100	931407-100	Cable, RDU Configuration Adapter
ASI-933428-100	933428-100	Cable, IRDM
ASI-933436-100	933426-100	Cable, IR Interface Dongle

ASTV Alignment Fixture

ASI-930005-101

OEM Equivalent:

OEM: Rockwell Collins
 Model Number:
 Part Number: 930005-101
 Manual:
 Manual Figure:

Units Tested:

Tailwind 300: TMU / DBS2100

Specifications:

Height: 8.75" Width: 12.25" Depth: 3.00"
 Power Requirements: Not required

This unit is manufactured to replace the OEM MN, PN, and/or manual figure listed in Form, Fit, and Function.

Description:

The ASI-930005-101 Alignment Fixture is used during installation and verification of the Rockwell Collins Tailwind 300 Tail Mounted Unit (TMU). The Alignment Fixture includes two inclinometers (PRO-3600 or equivalent Digital Protractors) attached to the alignment plate.

Equipment Supplied:

ASI MN	OEM PN	Description
PRO-3600	102029	Digital Protractor (Qty 2 Included)

Optional Equipment:

ASI MN	OEM PN	Description
--------	--------	-------------

Inverter Test Panel for PC-15

ASI-818-1

OEM Equivalent: Flite-Tronics MN: PN: TS-PC15-1 / TS-PC15B-1 Manual: 24-20-21 // 24-20-22 Figure: 4.1 / 7.1.3 // 4.1	UUT: PC-15/-15A/-15B/-15F/-15G PC-15BC/-15BC() Size: H: 10.5" W: 19.00" D: 17.00" Pwr: 28 VDC	Equipment Supplied: <table border="0"> <tr> <td><u>ASI MN</u></td> <td><u>Description</u></td> </tr> <tr> <td>ASI-18-81A</td> <td>Cable, ASI-818-1 to PC-15/-15A/-15B/-15F/PC-15BC/-15BC(D)</td> </tr> <tr> <td>ASI-18-81E</td> <td>Cable, ASI-818-1 Power Cable</td> </tr> </table>	<u>ASI MN</u>	<u>Description</u>	ASI-18-81A	Cable, ASI-818-1 to PC-15/-15A/-15B/-15F/PC-15BC/-15BC(D)	ASI-18-81E	Cable, ASI-818-1 Power Cable		
<u>ASI MN</u>	<u>Description</u>									
ASI-18-81A	Cable, ASI-818-1 to PC-15/-15A/-15B/-15F/PC-15BC/-15BC(D)									
ASI-18-81E	Cable, ASI-818-1 Power Cable									
Description: The ASI-818-1 Inverter Test Panel provides the power, loads and switching required to test the PC-15 and PC-15BC series of static inverters. The ASI-818-1 includes the cable to test the basic versions of the PC-15. Optional cables are available for various other versions. These are listed in the optional equipment section.		Optional Equipment: <table border="0"> <tr> <td><u>ASI MN</u></td> <td><u>Description</u></td> </tr> <tr> <td>ASI-18-81B</td> <td>Cable, ASI-818-1 to PC-15B(E)/PC-15-BC(E)</td> </tr> <tr> <td>ASI-18-81C</td> <td>Cable, ASI-818-1 to PC-15G</td> </tr> <tr> <td>ASI-18-81D</td> <td>Cable, ASI-818-1 to PC-15-BC(H)</td> </tr> </table>	<u>ASI MN</u>	<u>Description</u>	ASI-18-81B	Cable, ASI-818-1 to PC-15B(E)/PC-15-BC(E)	ASI-18-81C	Cable, ASI-818-1 to PC-15G	ASI-18-81D	Cable, ASI-818-1 to PC-15-BC(H)
<u>ASI MN</u>	<u>Description</u>									
ASI-18-81B	Cable, ASI-818-1 to PC-15B(E)/PC-15-BC(E)									
ASI-18-81C	Cable, ASI-818-1 to PC-15G									
ASI-18-81D	Cable, ASI-818-1 to PC-15-BC(H)									

Inverter Test Panel for PC-17 / SPC-60

ASI-818-2

OEM Equivalent: Flite-Tronics / KGS Flite-Tronics PN: TS-PC17-1 KGS PN: TS-SPC60()-1 Manual: 24-20-25 // 24-20-01 Figure: 4.1 // 701	UUT: PC-17 / -17-1 / -17-2 / -17-3 PC-17-3 / -3A / -3B / -3C SPC-60 / -60A / -60C Size: H: 10.5" W: 19.00" D: 17.00" Pwr: 28 VDC											
Description: The ASI-818-2 Inverter Test Panel provides the power, loads and switching required to test the PC-17 and SPC-60 series of static inverters. The ASI-818-2 includes the cable to test the most common versions of the PC-17 and SPC-60. An optional cable is available for testing the PC-17-3C. This cable is listed in the optional equipment section. The ASI-818-2 will not test the PC-17A Series or SPC-60B/-60E. The ASI-818-21 Test Panel is required to test the PC-17A Series and SPC-60E.		Optional Equipment: <table border="0"> <tr> <td><u>ASI MN</u></td> <td><u>Description</u></td> </tr> <tr> <td>ASI-18-82A</td> <td>Cable, ASI-818-1 Power Cable</td> </tr> <tr> <td>ASI-18-82B</td> <td>Cable, ASI-818-1 to PC-17() / SPC-60() (Except PC-17-3C)</td> </tr> <tr> <td>ASI-18-82C</td> <td>Cable, ASI-818-2 to PC-17-3C</td> </tr> <tr> <td>ASI-818-21</td> <td>Test Panel for PC-17A / -17A-1 / -17A-2 / SPC-60E</td> </tr> </table>	<u>ASI MN</u>	<u>Description</u>	ASI-18-82A	Cable, ASI-818-1 Power Cable	ASI-18-82B	Cable, ASI-818-1 to PC-17() / SPC-60() (Except PC-17-3C)	ASI-18-82C	Cable, ASI-818-2 to PC-17-3C	ASI-818-21	Test Panel for PC-17A / -17A-1 / -17A-2 / SPC-60E
<u>ASI MN</u>	<u>Description</u>											
ASI-18-82A	Cable, ASI-818-1 Power Cable											
ASI-18-82B	Cable, ASI-818-1 to PC-17() / SPC-60() (Except PC-17-3C)											
ASI-18-82C	Cable, ASI-818-2 to PC-17-3C											
ASI-818-21	Test Panel for PC-17A / -17A-1 / -17A-2 / SPC-60E											

Inverter Test Panel for PC-250 / PC-251 / PC-350

ASI-818-3

OEM Equivalent: Flite-Tronics MN: PN: Manual: 24-20-03 // 24-20-07 // 24-20-04 Figure: 101-103 // 101-103 // 101-103	UUT: PC-250 / PC-250() PC-251 / PC-251() / PC-251-123() PC-350 / PC-350() Size: H: 10.5" W: 19.00" D: 17.00" Pwr: 28 VDC																																									
Description: The ASI-818-3 Inverter Test Panel provides the power, loads and switching required to test the PC-250, PC-251 and PC-350 series of static inverters. The ASI-818-3 also includes the ability to test the phase lock circuitry in the inverter without additional power supplies. The ASI-818-3 includes the cables required to test the standard versions of the PC-250, PC-251 and PC-350. Optional cables are available for various other versions. These are listed in the optional equipment section.		Optional Equipment: <table border="0"> <tr> <td><u>ASI MN</u></td> <td><u>Description</u></td> </tr> <tr> <td>ASI-18-83A</td> <td>Cable, ASI-818-3 to PC-250 / PC-250-2A / PC-251 / PC-251-5B</td> </tr> <tr> <td>ASI-18-83S</td> <td>Cable, ASI-818-3 to PC-350 / PC-350-1B / -2A / -4A / -34A</td> </tr> <tr> <td>ASI-18-83U</td> <td>Cable, ASI-818-3 Power Cable</td> </tr> <tr> <td>ASI-18-83B</td> <td>Cable, ASI-818-3 to PC-250-1A</td> </tr> <tr> <td>ASI-18-83C</td> <td>Cable, ASI-818-3 to PC-250-1B</td> </tr> <tr> <td>ASI-18-83D</td> <td>Cable, ASI-818-3 to PC-250-1C / PC-251-1C</td> </tr> <tr> <td>ASI-18-83E</td> <td>Cable, ASI-818-3 to PC-251-1D / PC-251-5C</td> </tr> <tr> <td>ASI-18-83F</td> <td>Cable, ASI-818-3 to PC-251-3A</td> </tr> <tr> <td>ASI-18-83G</td> <td>Cable, ASI-818-3 to PC-251-3B</td> </tr> <tr> <td>ASI-18-83H</td> <td>Cable, ASI-818-3 to PC-251-5A</td> </tr> <tr> <td>ASI-18-83J</td> <td>Cable, ASI-818-3 to PC-251-15A / PC-251-15B / PC-251-15C</td> </tr> <tr> <td>ASI-18-83K</td> <td>Cable, ASI-818-3 to PC-251-123A</td> </tr> <tr> <td>ASI-18-83L</td> <td>Cable, ASI-818-3 to PC-251-123B</td> </tr> <tr> <td>ASI-18-83M</td> <td>Cable, ASI-818-3 to PC-251-123B(MOD C) / PC-251-123E</td> </tr> <tr> <td>ASI-18-83N</td> <td>Cable, ASI-818-3 to PC-251-123C</td> </tr> <tr> <td>ASI-18-83P</td> <td>Cable, ASI-818-3 to PC-251-123D</td> </tr> <tr> <td>ASI-18-83Q</td> <td>Cable, ASI-818-3 to PC-251-123F</td> </tr> <tr> <td>ASI-18-83R</td> <td>Cable, ASI-818-3 to PC-251-123J / PC-251-123J2 / PC-251-123JA</td> </tr> <tr> <td>ASI-18-83T</td> <td>Cable, ASI-818-3 to PC-350-1A</td> </tr> </table>	<u>ASI MN</u>	<u>Description</u>	ASI-18-83A	Cable, ASI-818-3 to PC-250 / PC-250-2A / PC-251 / PC-251-5B	ASI-18-83S	Cable, ASI-818-3 to PC-350 / PC-350-1B / -2A / -4A / -34A	ASI-18-83U	Cable, ASI-818-3 Power Cable	ASI-18-83B	Cable, ASI-818-3 to PC-250-1A	ASI-18-83C	Cable, ASI-818-3 to PC-250-1B	ASI-18-83D	Cable, ASI-818-3 to PC-250-1C / PC-251-1C	ASI-18-83E	Cable, ASI-818-3 to PC-251-1D / PC-251-5C	ASI-18-83F	Cable, ASI-818-3 to PC-251-3A	ASI-18-83G	Cable, ASI-818-3 to PC-251-3B	ASI-18-83H	Cable, ASI-818-3 to PC-251-5A	ASI-18-83J	Cable, ASI-818-3 to PC-251-15A / PC-251-15B / PC-251-15C	ASI-18-83K	Cable, ASI-818-3 to PC-251-123A	ASI-18-83L	Cable, ASI-818-3 to PC-251-123B	ASI-18-83M	Cable, ASI-818-3 to PC-251-123B(MOD C) / PC-251-123E	ASI-18-83N	Cable, ASI-818-3 to PC-251-123C	ASI-18-83P	Cable, ASI-818-3 to PC-251-123D	ASI-18-83Q	Cable, ASI-818-3 to PC-251-123F	ASI-18-83R	Cable, ASI-818-3 to PC-251-123J / PC-251-123J2 / PC-251-123JA	ASI-18-83T	Cable, ASI-818-3 to PC-350-1A
<u>ASI MN</u>	<u>Description</u>																																									
ASI-18-83A	Cable, ASI-818-3 to PC-250 / PC-250-2A / PC-251 / PC-251-5B																																									
ASI-18-83S	Cable, ASI-818-3 to PC-350 / PC-350-1B / -2A / -4A / -34A																																									
ASI-18-83U	Cable, ASI-818-3 Power Cable																																									
ASI-18-83B	Cable, ASI-818-3 to PC-250-1A																																									
ASI-18-83C	Cable, ASI-818-3 to PC-250-1B																																									
ASI-18-83D	Cable, ASI-818-3 to PC-250-1C / PC-251-1C																																									
ASI-18-83E	Cable, ASI-818-3 to PC-251-1D / PC-251-5C																																									
ASI-18-83F	Cable, ASI-818-3 to PC-251-3A																																									
ASI-18-83G	Cable, ASI-818-3 to PC-251-3B																																									
ASI-18-83H	Cable, ASI-818-3 to PC-251-5A																																									
ASI-18-83J	Cable, ASI-818-3 to PC-251-15A / PC-251-15B / PC-251-15C																																									
ASI-18-83K	Cable, ASI-818-3 to PC-251-123A																																									
ASI-18-83L	Cable, ASI-818-3 to PC-251-123B																																									
ASI-18-83M	Cable, ASI-818-3 to PC-251-123B(MOD C) / PC-251-123E																																									
ASI-18-83N	Cable, ASI-818-3 to PC-251-123C																																									
ASI-18-83P	Cable, ASI-818-3 to PC-251-123D																																									
ASI-18-83Q	Cable, ASI-818-3 to PC-251-123F																																									
ASI-18-83R	Cable, ASI-818-3 to PC-251-123J / PC-251-123J2 / PC-251-123JA																																									
ASI-18-83T	Cable, ASI-818-3 to PC-350-1A																																									

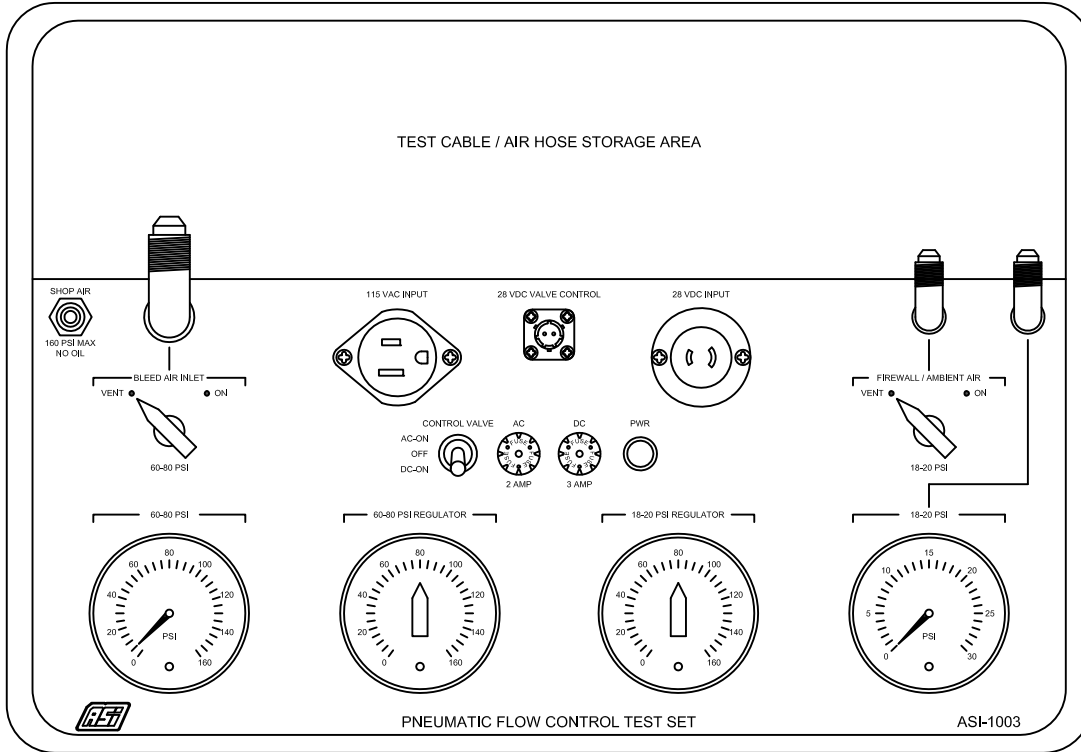

OEM Equivalent:

OEM:
 Model Number:
 Part Number:
 Manual:
 Manual Figure:

This unit is manufactured to replace the OEM MN, PN, and/or manual figure listed in Form, Fit, and Function.

Units Tested:

Pneumatic Aircraft Flow Control Valves

Description:

The ASI-1003 Test Set is a portable device for testing the operation of pneumatic aircraft flow control valves.

The ASI-1003 meets the following requirements:

1. Provides controllable 28 vdc at 2 amps from a standard 120 vac 50/60 Hz outlet or a 28 vdc aircraft battery with an on/off switch.
2. 100-120 PSI regulated shop air to be used to operate flow control valves.
3. Provides controllable 18-20 PSI filtered air for the firewall and ambient air valve that can release air quickly.
4. Provides controllable 60-80 PSI filtered air to bleed air inlet.
5. Functionally test flow controls on the bench or installed in the aircraft.
6. 0-30 PSI pressure gauge for checking flow control regulator.
7. Three additional AN-4 caps for open lines.
8. Items connected to the control valve (ASI-10-03A/B/C/F) can operate the part on the bench or installed on the aircraft (8 foot hoses and control cable).

The ASI-1003 and accessories are housed in a light weight portable watertight/airtight resin case.

Equipment Supplied:

ASI MN	Description
ASI-10-03A	Air Hose: ASI-1003 to Bleed Air Inlet (8 Ft #6)
ASI-10-03B	Air Hose: ASI-1003 to Firewall/Ambient Air Valves (8ft #4)
ASI-10-03C	Air Hose: ASI-1003 to Flow Control Regulator (8ft #4)
ASI-10-03D	Power Cable: ASI-1003 to 115 VAC 50-60 Hz (6ft)
ASI-10-03E	Power Cable: ASI-1003 to 28 VDC Aircraft Battery (20ft)
ASI-10-03F	Control Cable: ASI-1003 to Flow Control Regulator (8ft)
AN919-12D	Reducer with O-Ring
AN929-4D	Pressure Seal Cap (Qty-3)
4414K38	Spare 40 Micron Filter (Qty-2)

Optional Equipment:

ASI MN	OEM PN	Description
--------	--------	-------------

Specifications:

Height: 18.50" Width: 15.25" Depth: 6.875"
 Power Requirements: 115 VAC 50-60 Hz or 28 VDC

Pressure Sensor Electronic Test Panel

ASI-1004

OEM Equivalent:

OEM: Garrett
 Model Number: CT8122 (Formerly CT2601)
 Part Number:
 Manual: 36-27-12
 Manual Figure: 5-6

This unit is manufactured to replace the OEM MN, PN, and/or manual figure listed in Form, Fit, and Function.

Description:

The ASI-1004, when used in conjunction with the ASI-1005, is used to test the Garrett 627098 and 627100 Pressure Sensors.

The test panel accepts AC voltage signals from the uut and converts these signals to a DC voltage which is used to obtain the voltage ratio of the unit under test.

The ASI-1004 also contains a precision autotransformer which is used to periodically recertify the test panel.

The ASI-1004 includes the test cable (ASI-10-04A) which interconnects the ASI-1004 to the pressure sensor (627098 / 627100) being tested.

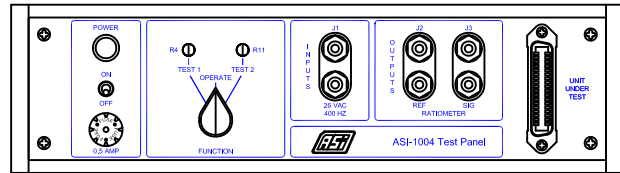

Units Tested:

627098
 627100

Specifications:

Height: 3.50" Width: 12.75" Depth: 15.00"
 Power Requirements: 115 VAC 60 Hz / 26 VAC 400 Hz

Equipment Supplied:

ASI MN	OEM PN	Description
ASI-10-04A	CT3112	Cable: ASI-1004 to 627098/627100

Optional Equipment:

ASI MN	OEM PN	Description
ASI-10-04B	CT8126	Cable: Ratio Box to 627098/627100
ASI-1005	CT2506	Pressure Sensor Pneumatic Test Panel

Pressure Sensor Pneumatic Test Panel

ASI-1005

OEM Equivalent:

OEM: Garrett
 Model Number: CT2506
 Part Number:
 Manual: 36-27-12
 Manual Figure: 5-7

This unit is manufactured to replace the OEM MN, PN, and/or manual figure listed in Form, Fit, and Function.

Description:

The ASI-1005, when used in conjunction with the ASI-1004, is designed to test the Garrett 627098 and 627100 Pressure Sensors.

This test panel is devoted entirely to pneumatic control. Source pressure is introduced into the test panel and applied to the unit under test through fittings on the front of the panel. The inlet valve is used to increase pressure and the bleed valve is used to decrease pressure as required. A variable volume pressure control is used to make fine pressure adjustments.

Internal over pressure switches protect against inadvertent over pressurization of the unit under test.

Pipe assemblies (ASI-10-05x) required to connect the ASI-1005 to the pressure sensors are included with the test panel.

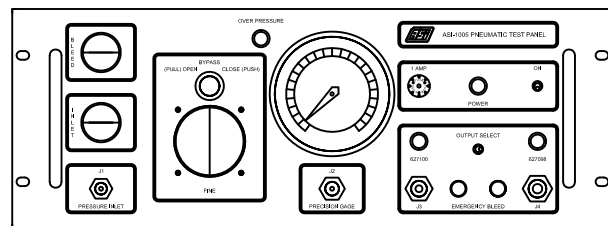

Units Tested:

627098
 627100

Specifications:

Height: 7.00" Width: 19.00" Depth: 17.00"
 Power Requirements: 115 VAC 60 Hz

Equipment Supplied:

ASI MN	OEM PN	Description
ASI-10-05A	CT8123	Pipe Assy, Pressure Gage
ASI-10-05B	CT8124	Pipe Assy, 627100
ASI-10-05C	CT8125	Pipe Assy, 627098

Optional Equipment:

ASI MN	OEM PN	Description
ASI-1004	CT8112	Pressure Sensor Electronic Test Panel

SPCU Test Set

ASI-1014

OEM Equivalent: Honeywell
 MN: NMN
 PN: CT21038
 Manual: D199709000113 / 24-60-02
 Manual Figure: 9001

UUT: 1151952-XX
 S281A601-3XXX
 Size: H: 13.00" W: 17.00" D: 3.00"
 Pwr: 28 VDC / 115 VAC 400 Hz

Description:
 The ASI-1014 SPCU Test Set works in conjunction with the ASI-1014-1 Load Bank and other standard shop equipment to test the 1151952-XX / S281A601-3XXX Standby Power Control Unit.

The ASI-1014 provides power input, interconnect, monitoring and discretives required during testing. Interconnection to the SPCU under test is accomplished with the attached 6 ft pendant cables. Loading (1.2Ω / 1.5Ω / 126Ω) is provided by the ASI-1014-1 Load Bank (The ASI-1014-1 must be purchased with the ASI-1014).

The optional ASI-1014-2 AC Power Panel is also available that will eliminate the need for the four individual W5MT3A Variacs called out in the CMM and aid in test interconnect.

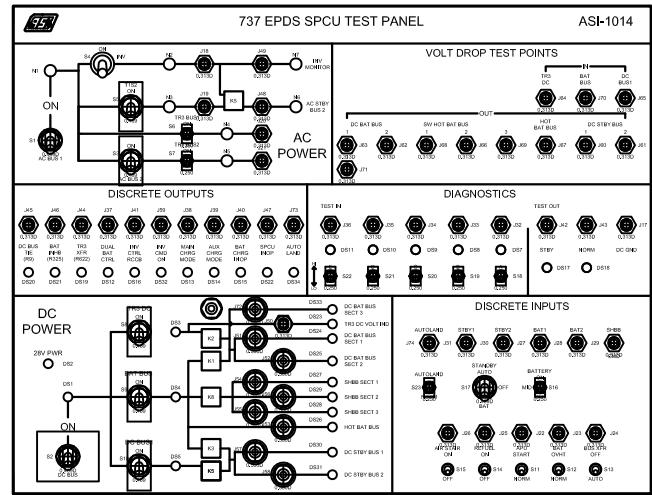

Equipment Supplied:
 ASI MN OEM PN Description

Optional Equipment:
 ASI MN OEM PN Description
 ASI-1014-1 CT24128 SPCU Load Bank (1.2Ω / 1.5Ω / 126Ω)
 ASI-1014-2 NPN AC Power Panel

SPCU Load Bank

ASI-1014-1

OEM Equivalent: Honeywell
 MN: NMN
 PN: CT24128
 Manual: D199709000113 / 24-60-02
 Manual Figure: 1001

UUT: 1151952-XX
 S281A601-3XXX
 Size: H: 9.00" W: 20.00" D: 3.00"
 Pwr:

Description:
 The ASI-1014-1 SPCU Load Bank works in conjunction with the ASI-1014 Test Set and other standard shop equipment to test the 1151952-XX / S281A601-3XXX Standby Power Control Unit.

The ASI-1014-1 provides the 1.2Ω, 1.5Ω and 126Ω loads required during testing of the SPCU (The ASI-1014-1 must be purchased with the ASI-1014).

The optional ASI-1014-2 AC Power Panel is also available that will eliminate the need for the four individual W5MT3A Variacs called out in the CMM.

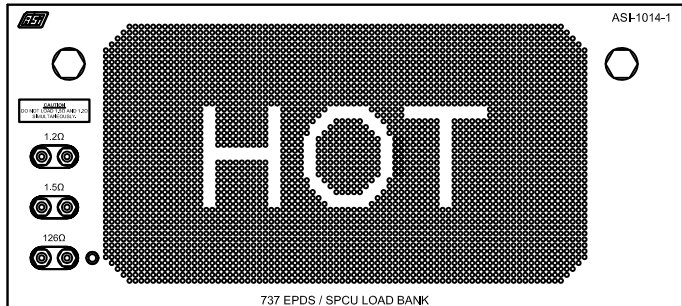

Equipment Supplied:
 ASI MN OEM PN Description

Optional Equipment:
 ASI MN OEM PN Description
 ASI-1014 CT21038 SPCU Test Set
 ASI-1014-2 NPN AC Power Panel

SPCU AC Power Panel

ASI-1014-2

OEM Equivalent: Honeywell
 MN: NMN
 PN: NPN
 Manual: D199709000113 / 24-60-02
 Manual Figure: 1001

UUT: 1151952-XX
 S281A601-3XXX
 Size: H: 10.50" W: 19.00" D: 17.00"
 Pwr: 115 VAC 400 Hz

Description:
 The ASI-1014-2 SPCU AC Power Panel works in conjunction with the ASI-1014 Test Set, ASI-1014-1 Load Bank and other standard shop equipment to test the 1151952-XX / S281A601-3XXX Standby Power Control Unit.

The ASI-1014-2 provides the four variable AC power sources required during testing of the SPCU. This will eliminate the need for the four individual W5MT3A Variacs called out in the CMM. The four DC power supply voltages are also routed from the rear to the front of the test panel for ease of accessibility during testing.

Cables required to interconnect the ASI-1014-2 to the DC Power supplies and the ASI-1014 Test Set are included with the AC Power Panel.

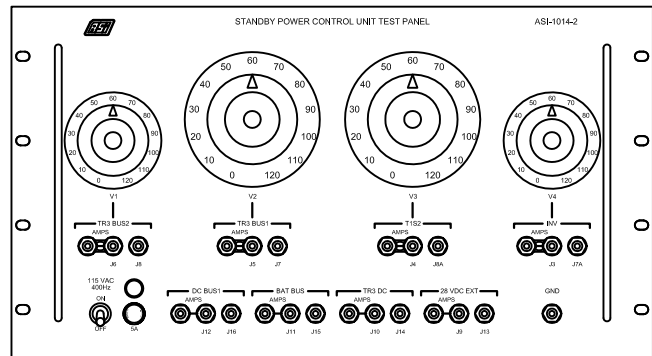

Equipment Supplied:
 ASI MN OEM PN Description
 ASI-10-142A NPN Cable, ASI-1014-2 to DC Power Supply (Qty 4)
 ASI-10-142B NPN Cable, ASI-1014-2 to ASI-1014 (Qty 10)

Optional Equipment:
 ASI MN OEM PN Description
 ASI-1014 CT21038 SPCU Test Set
 ASI-1014-1 CT24128 SPCU Load Bank (1.2Ω / 1.5Ω / 126Ω)

Interconnect Cable Set**ASI-2389-002**Description of Operation:

The ASI-2389-002 Interconnect Cable Set provides interface required when testing the Collins ARC-186 / VHF-186 with the AN/ARM-173 Radio Test Set.

Equivalent OEM: Collins
 Equivalent MN:
 Equivalent PN: 638-2389-002

Units Tested:
 ARC-186/VHF-186
 RT1299/RT1300/RT1354
 VCT-186B/K/KR/P/P1/R
 VCC-186/959W-1/640B-1
 VCN-186/C-11029()

Equipment Supplied:

ASI-9035-001	634-9035-001	Cable, W4
ASI-9036-001	634-9036-001	Cable, W5
ASI-9037-001	634-9037-001	Cable, W2
ASI-9038-001	634-9038-001	Cable, W1
ASI-9039-001	634-9039-001	Cable, W3

Manual Reference:

VHF-186 Vol. 2 VCT-186() Maintenance Table 4, Fig. 4 - 7
 VHF-186 Vol. 3 VCC-186 Maintenance Table 2, Fig. 4 - 7

Interconnect Cable Set**ASI-2390-001 / -002**Description of Operation:

The ASI-2390-00X Extender Set is used to extend the various modules in the ARC-186 / VHF-186 RT for testing and troubleshooting.

Equivalent OEM: Collins
 Equivalent PN:
 638-2390-001 (ASI-2390-001)
 638-2390-002 (ASI-2390-002)

Units Tested:
 ARC-186/VHF-186
 VCT-186B/K/KR/P/P1/R
 RT-1299/RT-1300/RT1354

Equipment Supplied:

The ASI-2390-002 is identical to the ASI-2390-001 with the three extra 1553B cables (marked with *)

ASI-9539-001	634-9539-001	Cable, Memory
ASI-9540-001	634-9540-001	Cable, Control
ASI-9541-001	634-9541-001	Cable, PA
ASI-9542-001	634-9542-001	Cable, ALC No. 1
ASI-9543-001	634-9543-001	Cable, ALC No. 2
ASI-2241-001	601-2241-001	Ext Card, RCVR IF
ASI-2242-001	601-2242-001	Ext Card, Audio
ASI-2243-001	601-2243-001	Ext Card, P/S
ASI-2244-001	601-2244-001	Ext Card, RCVR RF
ASI-9759-001	634-9759-001	Ext Card, SMO
ASI-7263-001*	752-7263-001	Cable, 1553 Analog
ASI-7264-001*	752-7264-001	Cable, 1553 Digital
ASI-7264-002*	752-7264-002	Cable, 1553 Inter.

The ASI-2390-001 / -002 is provided with a rugged case.

Manual Reference:

VHF-186 Vol. 2 VCT-186() Maintenance Fig. 9 - 10

Interconnect Cable Set**ASI-4015-186**Description of Operation:

The ASI-4015-186 Interconnect Cable Set provides interface required when testing the Collins ARC-186 / VHF-186 with the AN/ARM-165() Radio Test Set.

Equivalent OEM: Collins
 Equivalent MN:
 Equivalent PN: 647-4015-001

Units Tested:
 ARC-186/VHF-186
 RT-1299/RT-1300/RT-1354
 VCT-186B/K/KR/P/P1/R
 VCC-186/959W-1/640B-1
 VCN-186/C-11029()

Equipment Supplied:Manual Reference:

VHF-186 Vol. 2 VCT-186() Maintenance Table 5, Fig. 5 - 8
 VHF-186 Vol. 3 VCC-186 Maintenance Table 3, Fig. 5 - 8

ASI-4016-001	647-4016-001	Cable, W1
ASI-4093-001	647-4093-001	Cable, W2
ASI-4094-001	647-4094-001	Cable, W3
ASI-4095-001	647-4095-001	Cable, W4
ASI-4096-001	647-4096-001	Cable, W5

Interconnect Cable Set**ASI-6787-001**Description of Operation:

The ASI-6787-001 Interconnect Cable Set provides interface required when testing the Collins ARC-186 / VHF-186 Radio Set Control (C-11029() / VCN-186) with the AN/ARM-173 or AN/ARM-165() Radio Test Sets.

Equivalent OEM: Collins
 Equivalent MN: CTS-90
 Equivalent PN: 622-6787-001

Units Tested:
 ARC-186/VHF-186
 C-11029()/VCN-186

Equipment Supplied:

The ASI-6787-001 includes the CTS-90 Test Set and six cables required for testing.

ASI-CTS-90	622-6787-001	Test Set
ASI-9483-001	652-9483-001	Cable, W6
ASI-9484-001	652-9484-001	Cable, W7
ASI-9485-001	652-9485-001	Cable, W8
ASI-9486-001	652-9486-001	Cable, W9
ASI-9487-001	652-9487-001	Cable, W10
ASI-9488-001	652-9488-001	Cable, W11
ASI-1034-001	426-1034-001	Cable, Pwr

Manual Reference:

VHF-186 Vol. 3 VCN-186() Maintenance Fig. 6 - 11

REV 2
9-1-98

WRT-701X RF Alignment Kit

ASI-7994-701X

Equivalent OEM: Collins
 Equivalent MN:
 Equivalent PN: 659-7994-002
 Manual Figure: WRT-701X Appendix III Fig. III-4 - III-14A

Units Tested:
 WRT-701X Radar R/T
 WRT-701X Radar R/T (FLW)

Description of Operation:

The ASI-7994-701X RF Alignment Kit consists of all tuning/alignment tools, test fixtures, and extender cables necessary for testing and alignment of the RF section in the Collins WRT-701X Radar R/T. Also included are modified tuning covers that shield the particular module under test but allow access for tuning and adjustment. The ASI-7994-701X includes the following items:

RF ADAPTER KIT (659-7996-001):

QTY	CPN	RF ADAPTER	QTY	CPN	RF ADAPTER
4	357-9291-000	N-P/BNC-J	1	357-9919-020	BNC-P/SMB-J
1	357-7420-090	N-P/SMA-P	1	357-9919-030	BNC-P/SMB-J
1	357-7483-030	N-P/SMA-J	2	357-9329-000	BNC-J/BNC-J
1	357-7420-080	N-J/SMA-P	1	357-9339-000	BNC-J/BNC-P
3	357-7483-020	N-J/SMA-J	2	357-9337-000	BNC-P/BNC-P
1	357-9173-000	N-J/BNC-P	1	357-9314-000	BNC-J/P/J
2	357-7420-190	N-J/SMC-P	1	357-9687-000	BNC-P/J/P
2	357-7420-210	N-J/SMB-J	1	357-9689-000	BNC-J/J/J
2	357-7420-200	N-J/SMB-P	2	357-7448-030	SMA-J/SMA-J
2	357-9000-000	N-J/N-J	2	357-7448-040	SMA-P/SMA-P
4	357-9194-000	N-P/N-P	1	357-7417-010	SMA-J/SMA-P

EXTENDER CABLES:

QTY	CPN	CABLE	QTY	CPN	CABLE
2	651-1904-001	SMB-J/SMB-P	1	651-1904-007	T-CONNECTOR
1	651-1904-002	SMB-P/SMB-P	1	651-1904-008	MIXER A7
2	651-1904-003	PWR AMP/MULTIPLIER	1	651-1909-001	DRIVER EXT
3	651-1904-004	SMC-P/SMC-J	1	651-1914-001	SECOND IF A8 EXT
1	651-1904-005	SOURCE/DRIVER	1	NPN	MULTIPLIER GND
2	651-1904-006	DRIVER FILTER			

TUNING COVERS:

ADAPTERS:

QTY	CPN	COVER	QTY	CPN	ADAPTER
1	651-1902-001	PWR AMP COVER	1	651-1916-001	WAVEGUIDE
1	651-1915-001	MULTIPLIER QUAD CVR	1	651-1917-001	ANT PORT
1	830-2756-001	SGL CH MULTIPLIER CVR	1	651-1918-001	SHORT CIRCUIT
1	651-1910-001	MULTIPLIER TEST FIXTURE	2	651-1919-001	LIMITER A17
4	540-9200-003	A3/A4 STANDOFFS	1	651-1920-001	CPL LOAD PORT
			3	X281A (PE9801)	WAVEGUIDE/COAX

TOOLS: (647-0584-001/647-0420-001)

QTY	CPN	TOOL	QTY	CPN	TOOL
1	006-1493-000	PHILLIPS SCREW DRVR	1	024-0848-010	TWEEZERS
1	006-1294-100	.048" BRISTOL WRENCH	1	024-0799-040	WRENCH
1	006-1625-000	.035" HEX KEY	1	647-0420-002	19/64" SOCKET
1	024-0101-020	1/8" HEX T-HANDLE	1	647-0420-003	3/16" SOCKET
1	024-0058-000	1/16" HEX KEY	1	647-0420-004	1/4" SOCKET
1	024-0059-000	5/64" HEX KEY	1	647-0584-009	SCREWDRIVER
1	024-0458-000	ADJUSTMENT TOOL	1	647-0584-014	WHEEL SLIDER ADJ
			1	647-0584-015	ADJUSTER

Optional Equipment:

ASI MN	Equivalent PN	Description
ASI-738	622-5760-001	J-Box Test Fixture
ASI-6960-001	830-6960-001	FLW Alignment Kit

REV 3
5-1-98

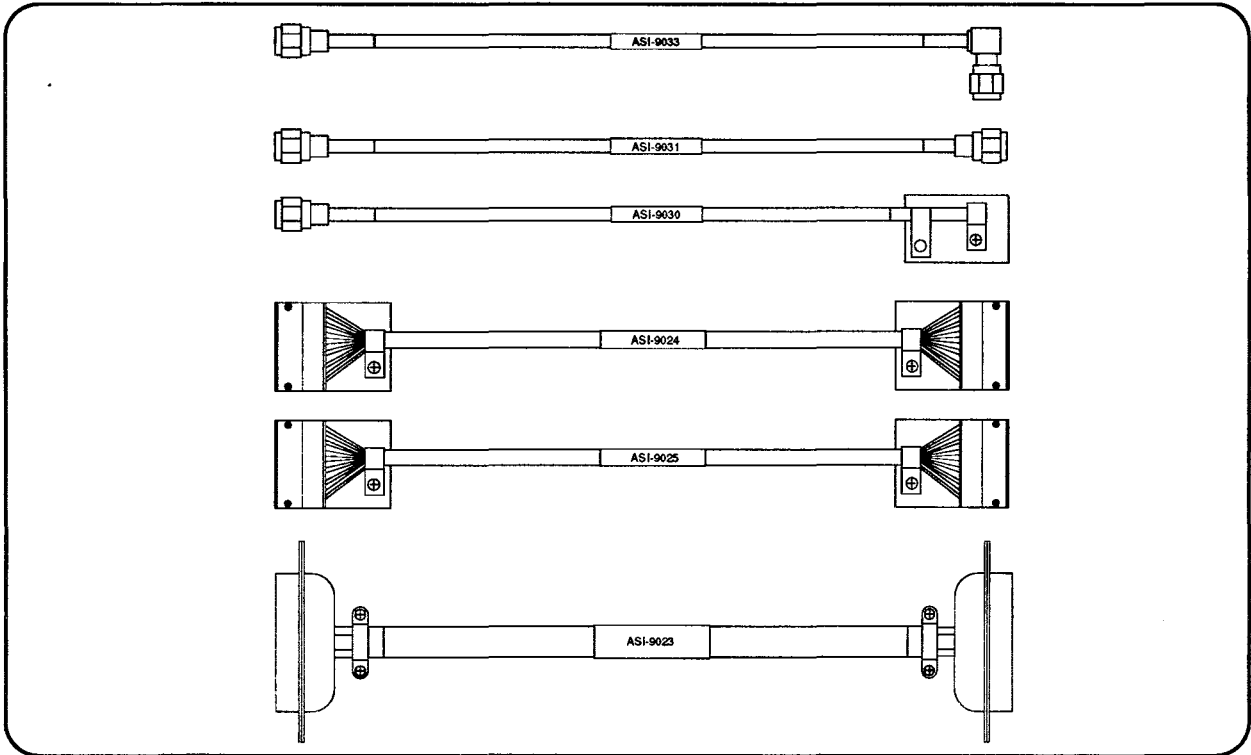

This unit is manufactured to replace the OEM model and/or part number listed below in form, fit, and function.

Equivalent OEM: Collins

Equivalent MN:

Equivalent PN: 629-9305-001

Manual Figure:

Units Tested:

TCN-118 Airborne TACAN System

Description of Operation:

The ASI-9305-118 Maintenance Kit includes all extender cables required to extend the modules of the Collins TCN-118 Airborne TACAN System for testing and troubleshooting purposes.

Specifications:

Height: Width: Depth: Power: None required

Equipment Supplied:

ASI MN	Equivalent PN	Description
ASI-9023	634-9023-001	Cable: Power Supply
ASI-9024	634-9024-001	Cable: Receiver
ASI-9025	634-9025-001	Cable: Synthesizer/Driver
ASI-9030	634-9030-001	Cable: RF
ASI-9031	634-9031-001	Cable: RF
ASI-9033	634-9033-001	Cable: RF

Optional Equipment:

ASI MN	Equivalent PN	Description
--------	---------------	-------------

Universal ATR Breakout Box

ASI-CTS-9

Description of Operation:

The ASI-CTS-9 is a Universal ATR Breakout Box used to gain access to all pins comprising up to three full-height, Thinline connectors. Signals to/from these connectors are available at the tip jacks mounted on the ASI-CTS-9 front panel. The tip jacks are labeled and color-coded to enhance usability.

Using the ASI-CTS-9 is simple and requires no modification to aircraft wiring, simply plug the ASI-CTS-9 between the wiring harness and the LRU to gain access to all inputs and outputs.

The ASI-CTS-9 uses full-height, 4-row (160 pin) Collins Thinline Connectors (qty 3).

The ASI-CTS-9 comes in a weather resistant carrying case for ease of handling and protection.

Equivalent OEM: Collins
Equivalent MN: CTS-9
Equivalent PN: 622-6720-001

Units Tested:
DPU-85()
FCC-85()
MPU-85()
DPU-86()
FCC-86()
MPU-86()

Equipment Specifications:

Height: 12.00" Width: 18.00" Depth: 17.00"
Total Cable Length: 19.00'

Optional Equipment

Universal ATR Breakout Box

ASI-CTS-10

Description of Operation:

The ASI-CTS-10 is a universal ATR Breakout Box used to gain access to all pins comprising up to three half-height, Thinline connectors. Signals to/from these connectors are available at the tip jacks mounted on the front panel of ASI-CTS-10 chassis box. These tip jacks are labeled and color coded to enhance usability.

Using the ASI-CTS-10 is simple and requires no modification to aircraft wiring, simply plug the ASI-CTS-10 between the wiring harness and the LRU to gain access to all inputs and outputs.

The ASI-CTS-10 uses half-height, 4 row (60 pin) Collins Thinline Connectors (qty 3).

All tip jacks are mounted on a protective chassis box for easy access.

Equivalent OEM: Collins
Equivalent MN: CTS-10
Equivalent PN: 622-4561-001

Units Tested:
AAC-85
ADC-80/81/82
ADC-85/86/850
AHC-85
ALT-50A/55B
ALT-4000
APA-80A/C/F/G/M
APC-65
APC-80
BIA-32
BRG-40
CAD-870G
CWC-80
DME-40/42/442
FGC-65
FGC-80
FPA-80
HPU-74
RNC-300
SDD-640
TDR-90/94/94D
161H-1
590A-3H/3J/3K
590A-3J1/3K1
860F-2
899P-1

Equipment Specifications:

Height: 3.50" Width: 15.00" Depth: 7.00"
Total Cable Length: 13.00'

Optional Equipment

RTA Test Panel

ASI-CTS-841

OEM Equivalent: Collins MN: CTS-841 PN: 822-0081-001 Manual: 523-0776660 Manual Fig: 1	UUT: TWR-850 / WXR-800/-840 Radar Systems RTA-800/-842/-844/-848/-852/-852L/-854/-858
	Size: H: 8.75" W: 19.00" D: 9.00" Pwr: 28 VDC / 26 VAC / 115 VAC 400 Hz

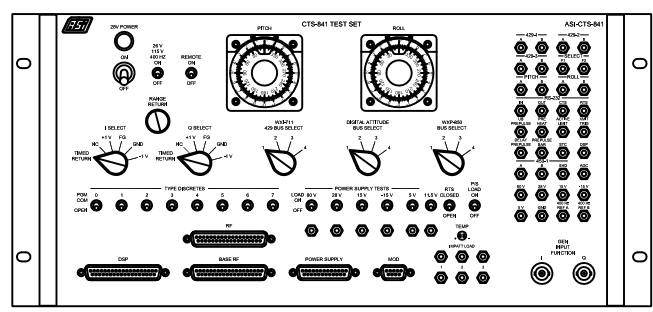

Description:
 The ASI-CTS-841 Test Panel works in conjunction with the 850W (ASI-378-9) Frequency Plan Adapter, WX1-711A Indicator, WXP-850A Radar Control, RDX-7708/-7708R Generator and other standard radar equipment to bench test the Rockwell Collins RTA-800/-84X/-85X Receiver/Transmitter/Antenna units of the TWR-850, WXR-800, and WXR-840 Weather Radar Systems.

The ASI-CTS-841 provides interconnection, power, switching, loading, and the pitch-roll source. The Test Panel also includes 17 test cables and the radar RF absorption barrel required during testing of the radar system.

The included ASI-CTS-840 is a radar RF absorption barrel that is used to house the RTA-8XX during final transmitter testing.

When testing the TWR-850 (RTA-85X) the RDX-7708/-7708R must be modified to incorporate additional circuitry required to test the turbulence radar functions. The optional ASI-RDX-01 provides this same functionality without having to modify the actual RDX-7708/-7708R. The Turbulence Test Adapters (ASI-378-4/-5) are also required during TWR-850 Testing.

The Avidyne FlightMax 950 Flight Situation Display (FSD) may be substituted for the WX1-711A Indicator during testing of the RTA-8XX. The FlightMax FSD must be equipped with the J5 Radar/429 Digital Radar Interface Card (PN 800-00002-010). Use of the FlightMax FSD requires the ASI-84-1R Alternate Indicator Cable.

Additional equipment manufactured by Avionics Specialist, Inc. for testing the RTA-8XX Radar/Transmitter/Antenna units is listed in the Associated Optional Equipment section below.

Equipment Supplied:

ASI MN	OEM PN	Description
ASI-84-1A	628-8847-001	DSP Cable
ASI-84-1B	628-8847-002	Power Supply Cable
ASI-84-1C	628-8847-003	RF Base Cable
ASI-84-1D	628-8847-004	RF Cable
ASI-84-1E	628-8847-005	WX1-711A Indicator Cable
ASI-84-1F	628-8847-006	RS-232 Terminal Cable
ASI-84-1G	628-8847-007	Modulator Cable
ASI-84-1H	628-8847-008	Digital Attitude Cable
ASI-84-1J	628-8847-009	WXP-850 Cable
ASI-84-1K	628-8847-010	Impatt Cable
ASI-84-1L	628-8847-011	RF Cable
ASI-84-1M	628-8847-012	RF Base Cable
ASI-84-1N	628-8847-013	RF Cable
ASI-84-1P	628-8847-014	RF Base Cable
ASI-84-1Q	628-8847-015	Power Supply Cable
ASI-84-1R	628-8847-016	Alternate Indicator Cable (FlightMax 950 FSD)
ASI-84-1S	628-8847-017	ETC Cable
ASI-CTS-840	822-0080-001	Radar Absorption Barrel (CTS-840)

Radar RF Absorption Barrel

ASI-CTS-840

OEM Equivalent: Collins MN: CTS-840 PN: 822-0080-001 Manual: 523-0776660 Manual Fig: 1	UUT: TWR-850 / WXR-800/-840 Radar Systems RTA-800/-842/-844/-848/-852/-852L/-854/-858
	Size: H: 24.00" W: 24.00" D: 36.00" Pwr: N/A

Equipment Supplied:

ASI MN	OEM PN	Description
--------	--------	-------------

Description:
 The ASI-CTS-840 is a radar RF absorption barrel that is used to house the RTA-800, RTA-84X and RTA-85X during final transmitter testing.

Associated Optional Equipment:

ASI MN	OEM PN	Description
ASI-26-9J	NPN	Power Cable Extender for Receiver Assembly 653-2349-001 (12 Pin/Double Row/Pin 8 Key)
ASI-26-9J1	NPN	Power Cable Extender for Receiver Assembly 659-7802-001 (8 Pin/Double Row/Pin 7 Key)
ASI-26-9K	NPN	Extender Cable for A7P1 of Interconnect Assembly 676-5300-00X, 827-3493-00X, and 628-6960-00X (28 Pin/Double Row/Pin 10 Key)
ASI-26-9K1	NPN	Extender Cable for P1 of Interconnect Assembly 628-9858-001/-002 (28 Pin/Double Row/Pin 17 Key)
ASI-26-9K2	NPN	Extender Cable for A4A5P1 of Interconnect Assembly 653-3853-001 (28 Pin/Double Row/Pin 6 Key)
ASI-26-9L	NPN	Scan to Scan Bypass Connector (16 Pin/Double Row/No Key)
ASI-26-9M	NPN	Tilt Error Adapter Cable (10 Pin/Double Row/Pin 10 Key)
ASI-26-9N	NPN	Power Cable Extender for Exciter Assembly 628-9744-002 (6 Pin/Single Row/No Key)
ASI-26-9N1	NPN	Power Cable Extender for Exciter Assembly 653-3839-001 (6 Pin/Single Row/Pin 3 Key)
ASI-269-1A	135-3603-026	Dial Indicator Mounting Post (3 Inch)
ASI-269-1B	135-3603-027	Dial Indicator Mounting Post (6 Inch)
ASI-269-2	NPN	Tilt Angle Mounting Fixture
ASI-269-3	NPN	Tilt / Scan Angle Measurement Adapter
ASI-269-4	827-2780-001	Tilt Sector Gear Puller
ASI-269-5A	827-2781-001	Scan Sector Gear Puller
ASI-269-5B	626-4247-001	Scan Sector Gear Puller
ASI-269-6	NPN	Fluke 9010A Test Adapter
ASI-269-7	NPN	Tilt Torsion Spring Installation / Removal Tool (Qty 2 Required)
ASI-269-8	815-2274-001	Buffer Adapter (With 2 Cables)
ASI-269-9	NPN	RF Test Cable Set (Includes Cables A(Qty 3), B, D, E, F, G, H, J, K, L(Qty 2), M, N, P, Q, R, S)
ASI-365-1	NPN	Test Adapter for Receiver Assembly 653-2349-001
ASI-365-2	NPN	Second IF Test Set
ASI-378-1	NPN	Exciter Assembly Test Set for 628-9744-002
ASI-378-2	NPN	Exciter Assembly Test Set for 628-9744-001
ASI-378-3	NPN	Turbulence Test Adapter for DSP/CPU Card 646-7991-011 (Replaced by ASI-378-5)
ASI-378-4	NPN	Turbulence Test Adapter for DSP/CPU Card 646-7991-012
ASI-378-5	NPN	Turbulence Test Adapter for DSP/CPU Card 646-7991-003 thru -011
ASI-378-6	NPN	RTA Flight-Line Test Fixture
ASI-378-7	NPN	WXP-840/850 Flight-Line Test Fixture
ASI-378-8	685-6238-001	WXP Interface Adapter Box
ASI-378-9	850W	Frequency Plan Adapter / Frequency Converter
ASI-CTC-429	822-0854-001	ARINC CTC-429 Smart Card (Requires 831-0990-007 Software)
ASI-CTS-956	NPN	Transmitter Assembly Test Panel
ASI-CTS-957	NPN	Receiver/Exciter Assembly Test Panel
ASI-RDX-01	638-0066-001	Turbulence Mod Fixture for RDX-7708/-7708R (Required for Testing Turbulence Radars: TRW-850: RTA-852 / -852L / -854 / -858)

TDR-94/94D ATE Test Panel

ASI-CTS-940

OEM Equivalent: Rockwell Collins MN: NMN PN: 628-8750-001 Manual: 523-0778502 Manual Figure: 1001 - 1002	UUT: TDR-94 622-9352-004 and Up TDR-94D 622-9210-004 and Up
	Size: H: 7.00" W: 19.00" D: 6.50" Pwr: 28 VDC

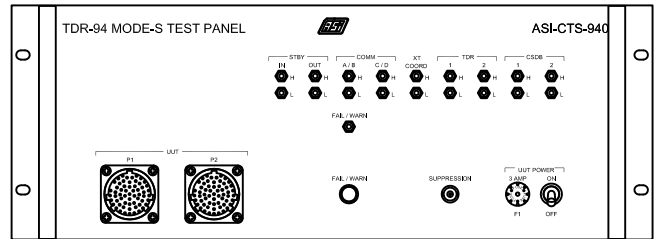

Description:
The ASI-CTS-940 Test Panel provides capability to test and repair the Collins TDR-94/94D Transponders. The Test Panel provides power, test points, discretes, and interconnection required for testing using the computer controlled ATE Test Station, Preferred or Alternate Testing Methods per the Collins TDR-94/94D Component Maintenance Manual. It is recommended that the ATE Test Station (653-5815-008) be used for all new applications.

The ASI-CTS-940 works in conjunction with a computer and various bench test equipment required for testing the UUT. See the Collins TDR-94/94D Component Maintenance Manual for a list of associated equipment required for proper testing of the Transponder. The required Test Software (listed below) must be purchased directly from Collins in order to ensure latest revision status.

TDR-94/94D Test Software:

815-5058-019	TDR-94/94D Test Software (ATE Test Station / 653-5815-008)
815-5058-017	TDR-94/94D Test Software (Preferred Method)
831-0311-012	TDR-94/94D Test Software (Alternate Method)

Equipment Supplied:

ASI MN	OEM PN	Description
ASI-94-0D	NPN	J12 Loopback Test Connector
ASI-94-0E	NPN	J13 Loopback Test Connector
HBL-7464V	368-0010-000	Power Input Connector

Optional Equipment Usage:
ATE Test Station: ASI-94-0A/A1 / ASI-94-0B1 / ASI-901
Preferred Method: ASI-94-0A/A1 / ASI-94-0F / ASI-94-0G / ASI-900-1
Alternate Method: ASI-94-0A/A1 / ASI-94-0B / ASI-94-0C / ASI-900-1

Optional Equipment:

ASI MN	OEM PN	Description
ASI-94-0A	628-8752-001	Cable, ASI-CTS-940 (P1-P2) to TDR-94/94D (4 FT)
ASI-94-0A1	628-8752-001	Cable, ASI-CTS-940 (P1-P2) to TDR-94/94D (9 FT)
ASI-94-0B	628-8753-001 A	Cable, ASI-CTS-940 (P3-6, P15) to ARINC Smart
ASI-94-0B1	628-8753-001 B	Cable, ASI-CTS-940 (P3-6, P15) to OmniBusBox
ASI-94-0C	628-8754-001	Cable, ASI-CTS-940 (P11) to Contec PIO 24/24L
ASI-94-0F	(Item 13+27)	Cable, ASI-CTS-940 (P11) to I/O Card (NI)
ASI-94-0G	(Item 12+28)	Cable, ASI-CTS-940 (P3-6, P15) to CEI-520/520C
ASI-900-1	983-8108-001	Time Tag Generator
ASI-901	638-1481-002	Multi-Function Panel (P/O 635-5815-008 ATE)

TDR-94/94D ATP Test Panel

ASI-CTS-941AR

OEM Equivalent: Rockwell Collins MN: NMN PN: NPN Manual: 523-0775652 / 523-0775997 Manual Figure: 5-5 / 901	UUT: TDR-94 622-9352-002/003 TDR-94D 622-9210-002/003
	Size: H: 5.25" W: 19.00" D: 6.00" Pwr: 28 VDC

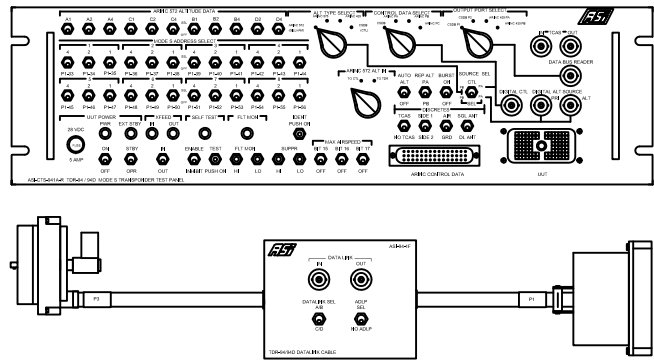

Description:
The ASI-CTS-941AR Acceptance Test Interconnect Panel provides the capability to manually test the Collins TDR-94/94D Transponder. The Test Panel provides power, test points, discretes, and interconnection required for testing using the Acceptance Test Procedures per the Collins TDR-94/94D Component Maintenance Manual. The Acceptance Test can be used as a Return to Service Test (RTS) per Collins TDR-94/94D Instruction Book (523-0775652).

The ASI-CTS-941AR works in conjunction with an ARINC 429/CSDB Data Bus reader and various bench test equipment required for testing the UUT. See the Collins TDR-94/94D Component Maintenance Manual for a list of associated equipment required for proper Acceptance Testing of the transponder.

The ASI-CTS-941AR is supplied with the ASI-94-1F (which includes the datalink test functions) and ASI-94-1K. Additional cables and test fixtures available from ASI are listed in the Optional Equipment section below.

Equipment Supplied:

ASI MN	OEM PN	Description
ASI-94-1F	NPN	Cable, TDR-94/94D (With Data Link)
ASI-94-1K	NPN	Cable, Single / Dual Antenna Port Cable

Optional Equipment:

ASI MN	UUT Manual Figure	Description
ASI-94-1A	523-0775997 Figure 908	Cable, RTU-870A/T Control
ASI-94-1B	523-0775997 Figure 907	Cable, CTL-92/92A Control
ASI-94-1C	N/A	Cable, Gables 816 / G7057 Control
ASI-94-1D	N/A	Cable, TDR-94/94D (Non Data Link)
ASI-94-1E	N/A	Cable, Single Antenna Port Cable
ASI-94-1G	523-0775997 Figure 903	IF Receiver/LVPS/HVPS Test Fixture
ASI-94-1G1	523-0775997 Figure 903	Cable W1, IF/LVPS/HVPS (p/o ASI-94-1G)
ASI-94-1H	523-0775997 Figure 904	Modulator Module A3 Test Fixture
ASI-94-1I	523-0775997 Figure 906	Cable, RFPA to IF Receiver (2 Required)
ASI-94-1J	523-0775997 Figure 909	Cable, TTC-920G
ASI-94-1L	523-0775997 Figure 905	Synthesizer Module A4 Test Fixture
ASI-94-1M	523-0775997 Table 902	Modulator Peak Current Detector Load
ASI-94-1N	523-0775997 Figure 913	Synthesizer Alignment Tools (Set of 4)
ASI-94-1O	523-0775997 Figure 914	Synth Alignment Probe Holder / Clip Rail
ASI-94-1Q	523-0775997 Figure 911	IF Receiver Module Alignment Cover A
ASI-94-1R	523-0775997 Figure 911	IF Receiver Module Alignment Cover B
ASI-94-1S	523-0775997 Figure 912	Trans/Rec Front End Alignment Cover
ASI-214	523-0775652 Figure 5-11	TDR-94/94D Flightline Test Set

TDR-94/94D ATP Test Fixture

ASI-CTS-941

OEM Equivalent: Rockwell Collins MN: NMN PN: NPN Manual: 523-0775652 / 523-0775997 Manual Figure: 5-5 / 901	UUT: TDR-94 622-9352-002/003 TDR-94D 622-9210-002/003
	Size: H: 8.00" W: 12.00" D: 3.00" Pwr: 28 VDC

Equipment Supplied:

ASI MN	OEM PN	Description
ASI-94-1K	NPN	Cable, Single / Dual Antenna Port Cable

Description:
The ASI-CTS-941 is functionally equivalent to the ASI-CTS-941AR with the following exceptions:
1. Manufactured in a chassis rather than a standard 19" rack mount configuration.
2. UUT cables are pendent (Attached / Non Removable) to the chassis.

The ASI-CTS-941 is supplied with the ASI-94-1K. Additional cables and test fixtures available from ASI are listed in the Optional Equipment section above.

Optional Equipment:

ASI MN	OEM PN	Description
ASI-CTS-940	628-8750-001	TDR-94/94D ATE Test Panel
ASI-CTS-941AR	NPN	TDR-94/94D ATP Test Panel
ASI-214	NPN	TDR-94/94D Flightline Test Set

ASI SPECIALIZED TEST EQUIPMENT LIST

AVAILABILITY SUBJECT TO CHANGE WITHOUT NOTICE

<u>ASI MN</u>	<u>EQUIV MN</u>	<u>EQUIV PN</u>	<u>DESCRIPTION</u>	<u>AVAILABILITY</u>
ASI-1			ADAPTER RACK: ARINC COMM TO VHF-20(), VHF-21()	ASI DEALER
ASI-1A			ADAPTER RACK: ARINC COMM TO VHF-22()	ASI DEALER
ASI-1B			ADAPTER RACK: ARINC COMM TO VHF-22C / VHF-22D	ASI DEALER
ASI-1C			ADAPTER RACK: ARINC COMM TO VHF-21C / VHF-21D	ASI DEALER
ASI-2			ADAPTER RACK: ARINC NAV TO VIR-30(), VIR-32()	ASI DEALER
ASI-2A			ADAPTER RACK: ARINC NAV TO VIR-31()	ASI DEALER
ASI-7			ADAPTER RACK: 860E-3/5 TO DME-40	ASI DEALER
ASI-10			SERVO AMPLIFIER	ASI DEALER
ASI-01-P55241U001		01-P55241U001	TYPE 2 RF TEST FIXTURE	ASI DEALER
ASI-050-2605-00	050-2605-00	050-02605-0000	ASYNC CARD KIT WITH 3 CABLES	ASI DEALER
ASI-050-2606-00	050-2606-00	050-02606-0000	SYNC CARD KIT WITH 2 CABLES	ASI DEALER
ASI-10-02A		940-ASI-10-02A	CABLE: ASI-1002 TO GABLES G7400 / G7412	GABLES
ASI-10-02B		940-ASI-10-02B	CABLE: ASI-1002 TO GABLES G7401	GABLES
ASI-10-02C		940-ASI-10-02C	CABLE: ASI-1002 TO G7402	GABLES
ASI-10-02D		940-ASI-10-02D	CABLE: ASI-1002 TO G7403	GABLES
ASI-10-02E		940-ASI-10-02E	CABLE: ASI-1002 TO G7404	GABLES
ASI-10-02F		940-ASI-10-02F	CABLE: ASI-1002 TO G7406	GABLES
ASI-10-02G		940-ASI-10-02G	CABLE: ASI-1002 TO G7500	GABLES
ASI-10-02H		940-ASI-10-02H	CABLE: ASI-1002 TO G6990/G6992/G7131/G7156 (TCAS CONTROLS)	GABLES
ASI-10-02H1		940-ASI-10-02H1	CABLE: ASI-1002 TO G6993 (TCAS CONTROLS)	GABLES
ASI-10-02H2		940-ASI-10-02H2	CABLE: ASI-1002 TO G6990/G6992 (ADSB)	GABLES
ASI-10-02J		940-ASI-10-02J	CABLE: ASI-1002 TO G6959	GABLES
ASI-10-02K		940-ASI-10-02K	CABLE: ASI-1002 TO G6977	GABLES
ASI-10-02L		940-ASI-10-02L	CABLE: ASI-1002 TO G6981	GABLES
ASI-10-02M		940-ASI-10-02M	CABLE: ASI-1002 TO G6982	GABLES
ASI-10-02N		940-ASI-10-02N	CABLE: ASI-1002 TO G6984	GABLES
ASI-10-02P1			CABLE: ASI-1002 TO DFP-702/-703/-712/-713	ASI DEALER
ASI-10-02P2			CABLE: ASI-1002 TO VFP-702/-712	ASI DEALER
ASI-10-02P3			CABLE: ASI-1002 TO DTP-702/-712	ASI DEALER
ASI-10-02P4			CABLE: ASI-1002 TO HFP-702/-712	ASI DEALER
ASI-10-02P5			CABLE: ASI-1002 TO DTP-722	ASI DEALER
ASI-10-02Q		940-ASI-10-02Q	CABLE: ASI-1002 TO G6966/G7024	GABLES
ASI-10-02R		940-ASI-10-02R	CABLE: ASI-1002 TO G7026	GABLES
ASI-10-02S		940-ASI-10-02S	CABLE: ASI-1002 TO G7023	GABLES
ASI-10-02T		940-ASI-10-02T	CABLE: ASI-1002 TO G7119	GABLES
ASI-10-02U		940-ASI-10-02U	CABLE: ASI-1002 TO G7165	GABLES
ASI-10-02V		940-ASI-10-02V	CABLE: ASI-1002 TO G7409	GABLES
ASI-10-02W		940-ASI-10-02W	CABLE: ASI-1002 TO G6773	GABLES
ASI-10-02X		940-ASI-10-02X	CABLE: ASI-1002 TO G7163	GABLES
ASI-10-02Y		940-ASI-10-02Y	CABLE: ASI-1002 TO G7131 (REPLACED BY ASI-10-02H)	GABLES
ASI-10-02Z		940-ASI-10-02Z	CABLE: ASI-1002 TO G7451	GABLES
ASI-10-02AA		940-ASI-10-02AA	CABLE: ASI-1002 TO G7503	GABLES
ASI-10-02AB		940-ASI-10-02AB	CABLE: ASI-1002 TO G7300	GABLES
ASI-10-02AC		940-ASI-10-02AC	CABLE: ASI-1002 TO G7532	GABLES
ASI-10-02AD		940-ASI-10-02AD	CABLE: ASI-1002 TO G7514	GABLES
ASI-10-02AE		940-ASI-10-02AE	CABLE: ASI-1002 TO G7185	GABLES
ASI-10-02AF		940-ASI-10-02AF	CABLE: ASI-1002 TO G7490/G7492 (REPLACED BY ASI-10-02AF1)	GABLES
ASI-10-02AF1		940-ASI-10-02AF1	CABLE: ASI-1002 TO G7490/G7492 (WITH AC PWR SWITCHING)	GABLES
ASI-10-02AG		940-ASI-10-02AG	CABLE: ASI-1002 TO G7511 (PS-440 / 071-01605-0101)	GABLES
ASI-10-02AH		940-ASI-10-02AH	CABLE: ASI-1002 TO G7501	GABLES
ASI-10-02AJ		940-ASI-10-02AJ	CABLE: ASI-1002 TO G6967	GABLES
ASI-10-02AK		940-ASI-10-02AK	CABLE: ASI-1002 TO G6200/G6223	GABLES
ASI-10-02AL		940-ASI-10-02AL	CABLE: ASI-1002 TO G6840	GABLES
ASI-10-02AM		940-ASI-10-02AM	CABLE: ASI-1002 TO G6762	GABLES
ASI-10-02AN			CABLE: ASI-1002 TO G6201	GABLES
ASI-10-02AP		940-ASI-10-02AP	CABLE: ASI-1002 TO G7418	GABLES
ASI-10-02AQ		940-ASI-10-02AQ	CABLE: ASI-1002 TO G7461	GABLES
ASI-10-02AR1			CABLE: ASI-1002 TO CTL-22D / CTL-22G / G7422-XXX	ASI DEALER
ASI-10-02AR2			CABLE: ASI-1002 TO CTL-23D / CTL-23G / G7423-XXX	ASI DEALER
ASI-10-02AR3			CABLE: ASI-1002 TO CTL-32G / G7432-XXX	ASI DEALER
ASI-10-02AR4			CABLE: ASI-1002 TO CTL-62G / G7462-XXX	ASI DEALER
ASI-10-02AR5			CABLE: ASI-1002 TO CTL-92G / G7492-XXX	ASI DEALER
ASI-10-02AR6			CABLE: ASI-1002 TO CTL-93T / G7493-XXX	ASI DEALER
ASI-10-022A1			CABLE: ASI-1002-2 BREAKOUT BOX TO MS24266R22B55SN	ASI DEALER
ASI-10-022A2			CABLE: ASI-1002-2 BREAKOUT BOX TO MS24266R22B55S6	ASI DEALER
ASI-10-022A3			CABLE: ASI-1002-2 BREAKOUT BOX TO MS24266R22B55S7	ASI DEALER
ASI-10-022A4			CABLE: ASI-1002-2 BREAKOUT BOX TO MS24266R22B55S8	ASI DEALER
ASI-10-022A5			CABLE: ASI-1002-2 BREAKOUT BOX TO MS24266R22B55S9	ASI DEALER
ASI-10-022A6			CABLE: ASI-1002-2 BREAKOUT BOX TO MS24266R22B55S10	ASI DEALER

AVAILABILITY:

ASI DEALER: CONTACT ANY ASI DEALER FOR QUOTE
 COLLINS: CONTACT ROCKWELL COLLINS FOR QUOTE
 GABLES: CONTACT GABLES ENGINEERING FOR QUOTE
 TELEPHONICS: CONTACT TELEPHONICS FOR QUOTE

ASI SPECIALIZED TEST EQUIPMENT LIST

AVAILABILITY SUBJECT TO CHANGE WITHOUT NOTICE

ASI MN	EQUIV MN	EQUIV PN	DESCRIPTION	AVAILABILITY
ASI-10-022B1			CABLE: ASI-1002-2 BREAKOUT BOX TO MS24266R16B24P	ASI DEALER
ASI-10-022B2			CABLE: ASI-1002-2 BREAKOUT BOX TO MS3126F20-39S	ASI DEALER
ASI-10-022B3			CABLE: ASI-1002-2 BREAKOUT BOX TO MS3126F22-55S	ASI DEALER
ASI-10-022B4			CABLE: ASI-1002-2 BREAKOUT BOX TO MS24266R16B24S6	ASI DEALER
ASI-10-022B5			CABLE: ASI-1002-2 BREAKOUT BOX TO MS24266R16B10SN	ASI DEALER
ASI-10-022B6			CABLE: ASI-1002-2 BREAKOUT BOX TO MS24266R16B24S9	ASI DEALER
ASI-10-022B7			CABLE: ASI-1002-2 BREAKOUT BOX TO MS3126F20-41S	ASI DEALER
ASI-10-022B8			CABLE: ASI-1002-2 BREAKOUT BOX TO MS24266R14B15S9	ASI DEALER
ASI-10-022B9			CABLE: ASI-1002-2 BREAKOUT BOX TO MS24266R16B24SN	ASI DEALER
ASI-10-022C1			CABLE: ASI-1002-2 BREAKOUT BOX TO MS3126F20-41SW	ASI DEALER
ASI-10-022C2			CABLE: ASI-1002-2 BREAKOUT BOX TO BACC63CB18-31SN	ASI DEALER
ASI-10-022C3			CABLE: ASI-1002-2 BREAKOUT BOX TO BACC63CB24-30SN	ASI DEALER
ASI-10-022C4			CABLE: ASI-1002-2 BREAKOUT BOX TO BACC63CB24-30S6	ASI DEALER
ASI-10-1A			CABLE: ASI-200-1 TO CTL-22	ASI DEALER
ASI-10-1B			CABLE: ASI-200-1 TO CTL-62	ASI DEALER
ASI-10-1C			CABLE: ASI-200-1 TO CTL-92	ASI DEALER
ASI-10-1D			CABLE: ASI-200-1 TO CTL-23	ASI DEALER
ASI-10-1D1			CABLE: CTL-X2 EXTENDER CABLE A6 (CTL-X2 MAN FIG 5-2)	ASI DEALER
ASI-10-1E			CABLE: CTL-X2 EXTENDER CABLE A2 (CTL-X2 MAN FIG 5-2)	ASI DEALER
ASI-10-1F			CABLE: CTL-X2 EXTENDER CABLE A3 (CTL-X2 MAN FIG 5-2)	ASI DEALER
ASI-10-1G			CABLE: CTL-X2 EXTENDER CABLE A1/A2/A6 (CTL-X2 MAN FIG 5-2)	ASI DEALER
ASI-10-2A			CABLE: EXTERNAL OBS RESOLVER TO ASI-200-2A, 2C, 2D	ASI DEALER
ASI-10-2B			CABLE: ASI-160B (HDG SYNCHRO AND 332C-10) TO ASI-200-2D	ASI DEALER
ASI-10-2C			CABLE: ASI-160() (HDG SYNCHRO AND RMI) TO ASI-200-2C VIA P7	ASI DEALER
ASI-10-2D			CABLE: MANUAL CONTROL NAV-750() TO ASI-2000 FOR VIR-() NAV UNITS	ASI DEALER
ASI-10-2E			CABLE: MANUAL CONTROL CTL-30 TO ASI-2000 FOR VIR-() NAV UNITS	ASI DEALER
ASI-10-2F			CABLE: ASI-161, 479V-3 OR 79V-3 TO ASI-200-2A, 2C, 2D	ASI DEALER
ASI-10-2G			CABLE: 332-C10 TO RMI-36 ADAPTER	ASI DEALER
ASI-10-2H			CABLE: ASI-200-2() TO 332C-10 AND VIR-31	ASI DEALER
ASI-10-2H1			CABLE: ASI-200-2() / ASI-10-02H TO 699Z-1	ASI DEALER
ASI-10-2I			CABLE: ASI-200-2D TO VIR-31(P3)	ASI DEALER
ASI-10-2J			CABLE: ASI-200-2D TO ASI-160() AND VIR-31	ASI DEALER
ASI-10-2K			CABLE: VIR-32 EXTENDER A5-36 POS (VIR-32 MAN FIG 5-9)	ASI DEALER
ASI-10-2L			CABLE: VIR-32 EXTENDER A5-26 POS (VIR-32 MAN FIG 5-9)	ASI DEALER
ASI-10-2M			CABLE: ASI-200-2() TO CTL-32	ASI DEALER
ASI-10-2N			CABLE: MANUAL CONTROL 313N-4B/BA TO ASI-2000 FOR VIR-() NAV UNITS	ASI DEALER
ASI-10-3A			CABLE: MANUAL CONTROL NAV-750() TO ASI-2000 FOR VHF-() COMM UNITS	ASI DEALER
ASI-10-3B			CABLE: MANUAL CONTROL CTL-20 TO ASI-2000 FOR VHF-() COMM UNITS	ASI DEALER
ASI-10-3C			CABLE: NAV-760 TO ASI-2000	ASI DEALER
ASI-10-3D			CABLE: ASI-200-3 TO CTL-22	ASI DEALER
ASI-10-5A			CABLE: CTL KEC-1030 / SQUAWK NAUT I TO ASI-2000 FOR DME-() UNITS	ASI DEALER
ASI-10-5B			CABLE: MAN CTL CTL-30 TO ASI-2000 FOR DME-40,42,IND-40,41,339F-12	ASI DEALER
ASI-10-5C			CABLE: MANUAL CONTROL ATC-1400 TO ASI-2000 FOR DME-40 AND DME-42	ASI DEALER
ASI-10-5D			CABLE: ASI-200-5 TO IND-40,41,339F-12, AND 313N-4D	ASI DEALER
ASI-10-5E			CABLE: ASI-200-5 TO ATC-1400 (COMPUTER TESTING ONLY)	ASI DEALER
ASI-10-7A			CABLE: ASI-200-7 TO KFS-564()	ASI DEALER
ASI-10-7B			CABLE: ASI-200-7 TO KFS-576()	ASI DEALER
ASI-10-7C			CABLE: ASI-200-7 TO KFS-579()	ASI DEALER
ASI-10-7D			CABLE: ASI-200-7 TO KFS-586()	ASI DEALER
ASI-10-7E			CABLE: ASI-200-7 TO KFS-598()	ASI DEALER
ASI-10-8A			CABLE: ASI-2000 TO CTL-20	ASI DEALER
ASI-10-8B			CABLE: ASI-2000 TO LTC-1	ASI DEALER
ASI-10-8C			CABLE: ASI-2000 TO NAV-750()	ASI DEALER
ASI-10-9A			CABLE: ASI-2000 TO CTL-30	ASI DEALER
ASI-10-9B			CABLE: ASI-2000 TO LVC-4	ASI DEALER
ASI-10-9C			CABLE: ASI-2000 TO NAV-750()	ASI DEALER
ASI-10-9D			CABLE: ASI-200-9 TO VIR-130A	ASI DEALER
ASI-10-10A			CABLE: ASI-61, 970W1 OR ANT-60A TO ASI-200-10	ASI DEALER
ASI-10-10B			CABLE: ASI-200-10 TO RMI-36	ASI DEALER
ASI-10-10C			CABLE: 332C-10 RMI TO ASI-200-10	ASI DEALER
ASI-10-10D			CABLE: ASI-2000 TO CTL-62	ASI DEALER
ASI-10-10E			CABLE: ASI-200-10 TO ASI-160()	ASI DEALER
ASI-10-10F			CABLE: ASI-200-10 TO 332C-10 AND 699Z-1 FOR TESTING ADF-462	ASI DEALER
ASI-10-10G			CABLE: ASI-200-10 TO CTL-60	ASI DEALER
ASI-10-11A			CABLE: CTL-22 TO ASI-2000 FOR VHF-422	ASI DEALER
ASI-10-11B			CABLE: CTL-23 TO ASI-2000 FOR VHF-23	ASI DEALER
ASI-10-12A			CABLE: ASI-2000 TO CTL-32	ASI DEALER
ASI-10-13A			CABLE: ASI-2000 TO CTL-32	ASI DEALER
ASI-10-14A			CABLE: MANUAL CONTROL 613L-3 TO ASI-2000 FOR TDR-90	ASI DEALER

AVAILABILITY:

ASI DEALER: CONTACT ANY ASI DEALER FOR QUOTE
 COLLINS: CONTACT ROCKWELL COLLINS FOR QUOTE
 GABLES: CONTACT GABLES ENGINEERING FOR QUOTE
 TELEPHONICS: CONTACT TELEPHONICS FOR QUOTE

ASI SPECIALIZED TEST EQUIPMENT LIST

AVAILABILITY SUBJECT TO CHANGE WITHOUT NOTICE

<u>ASI MN</u>	<u>EQUIV MN</u>	<u>EQUIV PN</u>	<u>DESCRIPTION</u>	<u>AVAILABILITY</u>
ASI-10-14B			CABLE: MANUAL CONTROL ASI-500-1 TO ASI-2000 FOR TDR-90	ASI DEALER
ASI-10-14C			CABLE: ASI-2000 TO CTL-90 FOR TDR-90	ASI DEALER
ASI-10-14D			CABLE: ASI-2000 TO CAD-62/CTL-92 FOR TDR-90	ASI DEALER
ASI-10-14E			CABLE: ASI-200-14 TO TDR-950	ASI DEALER
ASI-10-14F			CABLE: 4 FT CALIBRATED RF (RG58 N TO TNC) FOR TDR-90	ASI DEALER
ASI-10-17A-A2			CABLE: EXTENDER FOR A2 CIRCUIT CARD IN THE COLLINS RTU-870A	ASI DEALER
ASI-10-17A-A3			CABLE: EXTENDER FOR A3 CIRCUIT CARD IN THE COLLINS RTU-870A	ASI DEALER
ASI-10-19A			CABLE: ASI-200-19 TO RMI-30	ASI DEALER
ASI-10-19B			CABLE: ASI-200-19 TO RMI-36/BDI-36	ASI DEALER
ASI-10-20A			CABLE: ASI-200-20 TO DRI-55	ASI DEALER
ASI-10-27A	CT8070		CABLE: ASI-1027-1 (CT8069) AC POWER	ASI DEALER
ASI-10-27B	CT8071		CABLE: ASI-1027-1 (CT8069) TO ASI-1027-2 (CT8073)	ASI DEALER
ASI-10-27C	CT8046		CABLE: ASI-1027-1 (CT8069) DC POWER	ASI DEALER
ASI-10-27D	CT8072		CABLE: ASI-1027-1 (CT8069) TO UUT (624066-X)	ASI DEALER
ASI-10-27E	CT8058		CABLE: TEST LEAD	ASI DEALER
ASI-10-27F	CT3258		EXTENDER CARD: 624066-X A1	ASI DEALER
ASI-10-27G	CT3259		EXTENDER CARD: 624066-X A2-A3	ASI DEALER
ASI-10-27H	CT3260		EXTENDER CARD: 624066-X A4	ASI DEALER
ASI-10-37A			CABLE: FUNCTIONAL TEST (ASI-1037 TO KIDDE 473597-18/-19)	ASI DEALER
ASI-10-37B			CABLE: CARD-EDGE-CONNECTOR TEST (ASI-1037 TO KIDDE 473597-18/-19)	ASI DEALER
ASI-10-37C			CABLE: SMOKE TEST (FOR KIDDE 473597-18/-19)	ASI DEALER
ASI-10-37D			CABLE: INSULATION RESISTANCE TEST (FOR KIDDE 473597-18/-19)	ASI DEALER
ASI-10-40A		170453	CABLE: ASI-1040 TO KIDDE 474083	ASI DEALER
ASI-10-400A			CABLE: ASI-2000 P2 COLLINS TO ASI-400-(25P) 6FT	ASI DEALER
ASI-10-400B			CABLE: ASI-2000 P3 COLLINS TO ASI-400-(37P) 6FT	ASI DEALER
ASI-10-400C			CABLE: ASI-2000 J3 COLLINS TO ASI-400-(37P) 6FT	ASI DEALER
ASI-10-400D			CABLE: ASI-2000 429 COLLINS TO ASI-200()- (15P) 6FT	ASI DEALER
ASI-10-400E			CABLE: ASI-2000 J1 KING ASI-400-(25P) 6 FT	ASI DEALER
ASI-10-400F			CABLE: ASI-2000 J2 KING TO ASI-400-(25P) 6FT	ASI DEALER
ASI-10-400G			CABLE: ASI-2000 J3 KING TO ASI-400-(25P) 6 FT	ASI DEALER
ASI-10-400H			CABLE: ASI-2000 ASYNCH TO ASI-200()- (25P) 6 FT	ASI DEALER
ASI-10-401A			CABLE: ASI-401 J2 TO PROLINE PANEL J3 (2.5 FT)	ASI DEALER
ASI-10-401B			CABLE: ASI-401 J3 TO PROLINE PANEL P3 (2.5 FT)	ASI DEALER
ASI-10-401C			CABLE: ASI-401 J7 TO PROLINE PANEL P2 (2.5 FT)	ASI DEALER
ASI-10-401D			CABLE: ASI-401 J8 TO PROLINE PANEL ARINC 429 (2.5 FT)	ASI DEALER
ASI-10-401E			CABLE: ASI-401 J10 TO CTC-429 CARD P1 (3.5 FT)	ASI DEALER
ASI-10-401F			CABLE: ASI-401 J12 TO CTC-429 CARD J33 (3.5 FT)	ASI DEALER
ASI-10-401G			CABLE: ASI-401 J14 TO CTC-429 CARD J32 (3.5 FT)	ASI DEALER
ASI-10-401H			CABLE: CUSTOM FIT FOR ASI-2000, REPLACES ASI-10-401A/B/C/D	ASI DEALER
ASI-10-401I			CABLE: ASI-401 J2 TO PROLINE PANEL J3 (6 FT)	ASI DEALER
ASI-10-401J			CABLE: ASI-401 J3 TO PROLINE PANEL P3 (6 FT)	ASI DEALER
ASI-10-401K			CABLE: ASI-401 J7 TO PROLINE PANEL P2 (6 FT)	ASI DEALER
ASI-10-401L			CABLE: ASI-401 J8 TO PROLINE PANEL ARINC 429 (6 FT)	ASI DEALER
ASI-10-401M			CABLE: ASI-401 J10 TO CTC-429 CARD P1 (6 FT)	ASI DEALER
ASI-10-401N			CABLE: ASI-401 J12 TO CTC-429 CARD J33 (6 FT)	ASI DEALER
ASI-10-401O			CABLE: ASI-401 J14 TO CTC-429 CARD J32 (6 FT)	ASI DEALER
ASI-10-41A		149981	CABLE: ASI-1041 TO KIDDE 473889-04 (P1,P2)	ASI DEALER
ASI-10-41B		170361	CABLE: ASI-1041 TO KIDDE 473889-04 (P3)	ASI DEALER
ASI-10-41C			CABLE: ARINC CARD TEST FOR KIDDE 473889-04	ASI DEALER
ASI-10-43A		170819-3	CABLE: M3000 FUNCTIONAL TEST (DISCRETE) FOR KIDDE 474560	ASI DEALER
ASI-10-43B		170819-5	CABLE: M3000 IR TEST FOR KIDDE 474560	ASI DEALER
ASI-10-43C			CABLE: M3000 PROGRAMMING TEST FOR 474560	ASI DEALER
ASI-10-43D		170819-1	CABLE: M3000 FUNCTIONAL TEST (CAN) FOR KIDDEE 474560	ASI DEALER
ASI-10-44A		474560-4	CABLE: DISCRETE TO CAN ADAPTER FOR KIDDE 474560	ASI DEALER
ASI-10-500A			CABLE: ASI-500 TO ASI-2000 (NAV-COMM-DME)	ASI DEALER
ASI-10-2000A			CABLE: 4 FT EXTENDER ASI-2000 TO COMPUTER (COLLINS)	ASI DEALER
ASI-10-2000B			CABLE: 4 FT EXTENDER ASI-2000 TO COMPUTER (KING)	ASI DEALER
ASI-11-1A		634-9802-001	CABLE: ASI-CTS-11 (CTS-11) TO ADI-85	ASI DEALER
ASI-11-1B			CABLE: ASI-CTS-11/-11A/-12 TO ASI-167(978F-2S) OR ASI-165(CSS-10)	ASI DEALER
ASI-11-1C			CABLE: ASI-CTS-11A TO ADI-77	ASI DEALER
ASI-11-1D		647-8962-001	CABLE: ADI-77 EXTENDER	ASI DEALER
ASI-11-1E		647-8962-002	CABLE: ADI-77 EXTENDER	ASI DEALER
ASI-11-1F		647-8962-003	CABLE: ADI-77 EXTENDER	ASI DEALER
ASI-11-1G		647-8962-004	CABLE: ADI-77 EXTENDER	ASI DEALER
ASI-11-1H		647-8962-005	CABLE: ADI-77 EXTENDER	ASI DEALER
ASI-11-1I		647-8962-006	CABLE: ADI-77 EXTENDER	ASI DEALER
ASI-11-1J		647-8962-020	CABLE: ADI-77 EXTENDER	ASI DEALER
ASI-11-1K			TEST FIXTURE: ADI-77 GIMBAL ALIGNMENT FIXTURE	ASI DEALER
ASI-11-1L			CABLE: ADI-77 GIMBAL ALIGNMENT FIXTURE CABLE	ASI DEALER

AVAILABILITY:

ASI DEALER: CONTACT ANY ASI DEALER FOR QUOTE
 COLLINS: CONTACT ROCKWELL COLLINS FOR QUOTE
 GABLES: CONTACT GABLES ENGINEERING FOR QUOTE
 TELEPHONICS: CONTACT TELEPHONICS FOR QUOTE

ASI SPECIALIZED TEST EQUIPMENT LIST

AVAILABILITY SUBJECT TO CHANGE WITHOUT NOTICE

<u>ASI MN</u>	<u>EQUIV MN</u>	<u>EQUIV PN</u>	<u>DESCRIPTION</u>	<u>AVAILABILITY</u>
ASI-12-0A			CABLE: ASI-120 TO BRG-40	ASI DEALER
ASI-12-0B			CABLE: ASI-120 TO DME-40A	ASI DEALER
ASI-12-0C			CABLE: ASI-120 TO 332C-10/10B	ASI DEALER
ASI-12-0D			CABLE: ASI-120 TO IND-350G	ASI DEALER
ASI-12-0E			CABLE: ASI-120 TO 339F-12()	ASI DEALER
ASI-12-0F			CABLE: ASI-120 TO ASI-160B/160C	ASI DEALER
ASI-12-0G			CABLE: ASI-120 TO 313N-4D / 378N-2	ASI DEALER
ASI-12-1A		634-9003-001	CABLE: ASI-CTS-12 (CTS-12) TO HSI-85()	ASI DEALER
ASI-12-1B		634-9004-001	CABLE: ASI-CTS-12 (CTS-12) TO COLT CTS-703	ASI DEALER
ASI-12-1C			CABLE: ASI-CTS-12 (CTS-12) TO ASI-176/176A/176BR	ASI DEALER
ASI-12-1C1			CABLE: ASI-CTS-12 (CTS-12) TO ASI-176-1	ASI DEALER
ASI-12-1D			CABLE: ASI-121 TO BIA-32	ASI DEALER
ASI-12-1E			CABLE: ASI-121 TO RMI-30	ASI DEALER
ASI-12-1F			CABLE: ASI-121 TO RMI-36 / BDI-36	ASI DEALER
ASI-12-2A			CABLE: ASI-122 TO DDA-42	ASI DEALER
ASI-12-2B			CABLE: ASI-122 TO IND-40/41	ASI DEALER
ASI-12-2C			CABLE: ASI-122 TO 339F-8B	ASI DEALER
ASI-12-2D			CABLE: ASI-122 TO 339F-12()	ASI DEALER
ASI-12-2E			CABLE: ASI-122 TO 339F-18()	ASI DEALER
ASI-12-3A			CABLE: ASI-123 TO BDI-36	ASI DEALER
ASI-12-3B			CABLE: ASI-123 TO COLT CTA-339B1	ASI DEALER
ASI-12-3C			CABLE: ASI-123 TO ASI-176()	ASI DEALER
ASI-12-3C1			CABLE: ASI-123 TO ASI-176-1	ASI DEALER
ASI-12-4A			CABLE: ASI-124 TO CAD-870G - P1	ASI DEALER
ASI-12-4B			CABLE: ASI-124 TO CAD-870G - P2	ASI DEALER
ASI-12-5A			CABLE: ASI-125 TO VHF-21	ASI DEALER
ASI-12-5B			CABLE: ASI-125 TO CTL-22	ASI DEALER
ASI-12-5C			CABLE: ASI-125 TO VHF-22	ASI DEALER
ASI-12-5D			CABLE: ASI-125 TO VHF-422	ASI DEALER
ASI-12-51A			CABLE: ASI-125-1 TO VHF-22() AND CTL-20	ASI DEALER
ASI-12-51B			CABLE: ASI-125-1 TO VHF-22() AND CTL-22	ASI DEALER
ASI-12-6A			CABLE: ASI-126 TO CTL-22/22A	ASI DEALER
ASI-12-6B			CABLE: ASI-126 TO CTL-32/32A	ASI DEALER
ASI-12-6C			CABLE: ASI-126 TO CTL-62/62A	ASI DEALER
ASI-12-6D			CABLE: ASI-126 TO CTL-92/92A	ASI DEALER
ASI-12-6E			CABLE: ASI-126 TO CTL-23	ASI DEALER
ASI-12-7A			CABLE: ASI-127 TO VIR-31()	ASI DEALER
ASI-12-7B			CABLE: ASI-127 / ASI-127-1 TO RMI-30	ASI DEALER
ASI-12-7C			CABLE: ASI-127 / ASI-127-1 TO RMI-36	ASI DEALER
ASI-12-7D			CABLE: ASI-127 / ASI-127-1 TO ASI-161 (479V-3)	ASI DEALER
ASI-12-7E			CABLE: ASI-127 / ASI-127-1 TO 313N-4B	ASI DEALER
ASI-12-7F			CABLE: ASI-127 / ASI-127-1 TO CTL-30	ASI DEALER
ASI-12-7G			CABLE: ASI-127 / ASI-127-1 TO ASI-190()	ASI DEALER
ASI-12-71A			CABLE: ASI-127-1 TO VIR-30/-31/-32/-33	ASI DEALER
ASI-12-71B			CABLE: ASI-127-1 TO CTL-32	ASI DEALER
ASI-12-71C			CABLE: ASI-127-1 TO 699Z-1	ASI DEALER
ASI-12-8A			CABLE: ASI-128 TO CTL-32	ASI DEALER
ASI-12-8B			CABLE: ASI-128 TO VIR-32	ASI DEALER
ASI-12-8C			CABLE: ASI-128 TO VIR-432	ASI DEALER
ASI-12-8D			CABLE: ASI-128 TO 332C-10	ASI DEALER
ASI-12-8E			CABLE: ASI-128 TO ASI-161 (479V-3)	ASI DEALER
ASI-12-8F			CABLE: ASI-128 TO ASI-160() OR ASI-190() OBS	ASI DEALER
ASI-12-8G			CABLE: ASI-128 TO ASI-160() OBI	ASI DEALER
ASI-12-8H			CABLE: ASI-128 TO RMI-36	ASI DEALER
ASI-12-9A			CABLE: ASI-129 TO CAD-31, CAD-62	ASI DEALER
ASI-13-0A			CABLE: ASI-130 TO 613L-3	ASI DEALER
ASI-13-0B			CABLE: ASI-130 TO CAD-62 / CTL-92	ASI DEALER
ASI-13-0C			CABLE: ASI-130 TO TDR-90	ASI DEALER
ASI-13-0D			CABLE: ASI-130 TO CTL-90	ASI DEALER
ASI-13-1A			CABLE: ASI-131 TO CTL-230	ASI DEALER
ASI-13-2A			CABLE: ASI-132 TO RAC-870 / CAD-870	ASI DEALER
ASI-13-3A			CABLE: ASI-133 TO RTU-870()	ASI DEALER
ASI-13-4A			CABLE: ASI-134 TO DME-42	ASI DEALER
ASI-13-4B			CABLE: ASI-134 TO IND-42/B	ASI DEALER
ASI-13-4C			CABLE: ASI-134 TO IND-40, IND-41, 339F-12	ASI DEALER
ASI-13-4D			CABLE: ASI-134 TO CTL-30	ASI DEALER
ASI-13-4E			CABLE: ASI-134 TO 313N-4D	ASI DEALER
ASI-13-4F			CABLE: ASI-134 TO CTL-32	ASI DEALER
ASI-13-4G			CABLE: ASI-134 TO SQUAWK NAUT	ASI DEALER

AVAILABILITY:

ASI DEALER: CONTACT ANY ASI DEALER FOR QUOTE
 COLLINS: CONTACT ROCKWELL COLLINS FOR QUOTE
 GABLES: CONTACT GABLES ENGINEERING FOR QUOTE
 TELEPHONICS: CONTACT TELEPHONICS FOR QUOTE

ASI SPECIALIZED TEST EQUIPMENT LIST

AVAILABILITY SUBJECT TO CHANGE WITHOUT NOTICE

<u>ASI MN</u>	<u>EQUIV MN</u>	<u>EQUIV PN</u>	<u>DESCRIPTION</u>	<u>AVAILABILITY</u>
ASI-13-4H			CABLE: ASI-134 TO DME-442	ASI DEALER
ASI-13-4I			CABLE: ASI-134 TO IFR-1400A	ASI DEALER
ASI-13-4J			CABLE: DME-42/442 PS LOAD TEST FIXTURE	ASI DEALER
ASI-13-5A			CABLE: ASI-135 TO ADF-462-P1	ASI DEALER
ASI-13-5B			CABLE: ASI-135 TO ADF-462-J7	ASI DEALER
ASI-15-1A			CABLE: ASI-151 TO 590A-3()	ASI DEALER
ASI-15-2A		2038272-0501	CABLE: ASI-152 (RDT-1F) W101	ASI DEALER
ASI-15-2B		2038273-0501	CABLE: ASI-152 (RDT-1F) W102	ASI DEALER
ASI-15-2C		2038274-0501	CABLE: ASI-152 (RDT-1F) W103	ASI DEALER
ASI-15-2D		2038275-0501	CABLE: ASI-152 (RDT-1F) W104	ASI DEALER
ASI-15-3A		2038308-0501	CABLE: ASI-153 (ATT-1T) W101	ASI DEALER
ASI-15-3B		2038309-0501	CABLE: ASI-153 (ATT-1T) W102	ASI DEALER
ASI-15-3C		8056302-0501	CABLE: ASI-153 (ATT-1T) W103	ASI DEALER
ASI-15-4A		2038350-0501	CABLE: ASI-154 (RCT-1F) W101	ASI DEALER
ASI-15-4B		2038351-0501	CABLE: ASI-154 (RCT-1F) W102	ASI DEALER
ASI-15-4C		2038352-0501	CABLE: ASI-154 (RCT-1F) W103	ASI DEALER
ASI-15-4D		2038353-0501	CABLE: ASI-154 (RCT-1F) W104	ASI DEALER
ASI-15-5A			CABLE: ASI-155 TO UDI CONNECTOR (2DE-19SBRP)	ASI DEALER
ASI-15-5B			CABLE: ASI-155 TO UDI CONNECTOR (14-19S)	ASI DEALER
ASI-15-5C			CABLE: ASI-155 TO UDI CONNECTOR (14-33S)	ASI DEALER
ASI-15-6A		685-6590-001	CABLE: ASI-156 TO AHC-85	ASI DEALER
ASI-15-8A		687-9993-001	CABLE: ASI-158 TO SVO-1000	ASI DEALER
ASI-15-8B		830-2523-001	CABLE: ASI-158 TO BCA-770	ASI DEALER
ASI-15-22A		8056334-0501	CABLE: ASI-152-2 (RDT-1FB) W101	ASI DEALER
ASI-15-22B		2041576-0502	CABLE: ASI-152-2 (RDT-1FB) W102	ASI DEALER
ASI-15-22C		2038274-0501	CABLE: ASI-152-2 (RDT-1FB) W103	ASI DEALER
ASI-15-22D		2038275-0502	CABLE: ASI-152-2 (RDT-1FB) W104	ASI DEALER
ASI-15-42A		8056346-0501	CABLE: ASI-154-2 (RCT-1FB) W101	ASI DEALER
ASI-15-42B		2041574-0502	CABLE: ASI-154-2 (RCT-1FB) W102	ASI DEALER
ASI-15-42C		2038352-0502	CABLE: ASI-154-2 (RCT-1FB) W103	ASI DEALER
ASI-15-42D		2038353-0502	CABLE: ASI-154-2 (RCT-1FB) W104	ASI DEALER
ASI-15-42E		8056342-0501	CABLE: ASI-154-2 (RCT-1FB) W105	ASI DEALER
ASI-16-B1			CABLE: ASI-160B/C TO KNI-582	ASI DEALER
ASI-16-B2			CABLE: ASI-160B/C TO RMI-36	ASI DEALER
ASI-16-B3			CABLE: ASI-160B/C TO LINAIRE LV-5 PANEL	ASI DEALER
ASI-16-B4			CABLE: ASI-160() / ASI-190() TO 479V-3 MOCK-UP ADAPTER	ASI DEALER
ASI-16-B5			CABLE: ASI-160B/C TO COLLINS 977A-1 (TB2)	ASI DEALER
ASI-16-B6			CABLE: ASI-160B/C TO LINAIRE LV-6 PANEL	ASI DEALER
ASI-16-3A			CABLE: ASI-163 TO PRIMUS-90 R/T	ASI DEALER
ASI-16-3B			CABLE: ASI-163 TO PRIMUS-90 IND	ASI DEALER
ASI-16-3C			CABLE: ASI-163 TO PRIMUS-90 ANT	ASI DEALER
ASI-16-3D			CABLE: ASI-163 TO PRIMUS-90 W/G SWITCH	ASI DEALER
ASI-16-3E			CABLE: ASI-163 TO PRIMUS-40/300/400/500 R/T	ASI DEALER
ASI-16-3F			CABLE: ASI-163 TO PRIMUS-40/300/400/500 IND	ASI DEALER
ASI-16-3G			CABLE: ASI-163 TO PRIMUS-40/300/400/500 ANT	ASI DEALER
ASI-16-3H			PRIMUS R/T MAG CURRENT/AFC TEST SET	ASI DEALER
ASI-16-3J			CABLE: PRIMUS R/T STABILIZATION ADAPTER	ASI DEALER
ASI-16-4A			CABLE: ASI-164 TO 339H-1/1A/1D, 339H-2(-001), 339H-6(-001)	ASI DEALER
ASI-16-4B			CABLE: ASI-164 TO 339H-2, 339H-6	ASI DEALER
ASI-16-4C			CABLE: ASI-164 TO 339H-5	ASI DEALER
ASI-16-4D			CABLE: ASI-164 TO INA-51A, INA-51B, INA-51D, INA-51V	ASI DEALER
ASI-16-4E			CABLE: ASI-164 TO 339H-3, 339H-4	ASI DEALER
ASI-16-6A		540-7245-000	CABLE: ASI-166 (479X-2) TO OBI (331-3F/3G)	ASI DEALER
ASI-16-6B			CABLE: ASI-166 (479X-2) TO ASI-160/190 SERIES	ASI DEALER
ASI-16-6C		540-7246-000	CABLE: ASI-166 (479X-2) TO OBS (INCLUDED WITH PURCHASE OF ASI-166)	ASI DEALER
ASI-16-6D		540-7244-000	30 HZ FILTER FOR ASI-166 (479X-2) (INCLUDED WITH PURCHASE OF ASI-166)	ASI DEALER
ASI-16-6E			CABLE: ASI-166 (479X-2) TO FMC-28/28A (ORZ)	ASI DEALER
ASI-16-6F		506-4851-002	CABLE: COAX	ASI DEALER
ASI-16-6G		540-7247-000	CABLE: VOLTMETER	ASI DEALER
ASI-16-8A			CABLE: ASI-168 TO 332D-11	ASI DEALER
ASI-16-8B			332D-11 ROTOR END CAP PULLER	ASI DEALER
ASI-16-8C1			332D-11 ROTOR PLUG SPANNER WRENCH	ASI DEALER
ASI-16-8C2			332D-11 PIVOT SPANNER WRENCH	ASI DEALER
ASI-16-8D			332D-11 ROTOR END CAP PRESS AND BASE TOOL	ASI DEALER
ASI-16-8E1			332D-11 BEARING REMOVER	ASI DEALER
ASI-16-8E2			332D-11 BEARING PRESS TOOL	ASI DEALER
ASI-16-8E3			332D-11 BASE TOOL	ASI DEALER
ASI-16-8E4			332D-11 OIL RETAINING PRESS TOOL	ASI DEALER
ASI-16-8E5			332D-11 ARBOR HOLDING PLATE	ASI DEALER

AVAILABILITY:

ASI DEALER: CONTACT ANY ASI DEALER FOR QUOTE
 COLLINS: CONTACT ROCKWELL COLLINS FOR QUOTE
 GABLES: CONTACT GABLES ENGINEERING FOR QUOTE
 TELEPHONICS: CONTACT TELEPHONICS FOR QUOTE

ASI SPECIALIZED TEST EQUIPMENT LIST

AVAILABILITY SUBJECT TO CHANGE WITHOUT NOTICE

<u>ASI MN</u>	<u>EQUIV MN</u>	<u>EQUIV PN</u>	<u>DESCRIPTION</u>	<u>AVAILABILITY</u>
ASI-16-8EX1			332d-11 EXTENDER CABLE (4 FT)	ASI DEALER
ASI-16-8F			332D-11 BALANCE MACHINE GYRO MOUNTING ADAPTER (GYROS WITHOUT SB 26)	ASI DEALER
ASI-16-8G			332D-11 GISHOLT HS-2 BALANCE MACHINE ADAPTER	ASI DEALER
ASI-16-8H			332D-11 BALANCE MACHNE GYRO MOUNTING ADAPTER (GYROS WITH SB 26)	ASI DEALER
ASI-16-8I			332D-11 DRILLING UNIT ADAPTER	ASI DEALER
ASI-16-8J			332D-11 BRUSH ADJUSTMENT TOOL	ASI DEALER
ASI-16-8K			332D-11 BRUSH TENSION GAGE	ASI DEALER
ASI-16-8L			332D-11 DIAL INDICATOR MOUNTING POST	ASI DEALER
ASI-16-8M			332D-11 END PLAY ADJUSTMENT SPACER (QTY 2 REQUIRED)	ASI DEALER
ASI-16-8N1			332D-11 TORQUE STATOR CEMENTING FIXTURE	ASI DEALER
ASI-16-8N2			332D-11 RING ASSEMBLY CEMENTING FIXTURE	ASI DEALER
ASI-16-8N3			332D-11 SOLENOID PLUNGER CEMENTING FIXTURE	ASI DEALER
ASI-16-8O			332D-11 TEST COVER	ASI DEALER
ASI-16-8P			332D-11 WOODEN BLOCK	ASI DEALER
ASI-16-8Q1			332D-11 GYRO RUN IN FIXTURE FOR UNITS WITHOUT SB 26	ASI DEALER
ASI-16-8Q2			332D-11 BONDING / RUN IN FIXTURE FOR UNITS WITH SB 26	ASI DEALER
ASI-16-8Q3			332D-11 GYROMOTOR RUN IN FIXTURE	ASI DEALER
ASI-16-8R			332D-11 EPOXY APPLICATION TOOL	ASI DEALER
ASI-16-8S			332D-11 BEARING RACE CLEANING FIXTURE	ASI DEALER
ASI-16-8T1			332D-11 BEARING BONDING WEIGHT	ASI DEALER
ASI-16-8T2			332D-11 ROTOR END CAP / BEARING BONDING FIXTURE	ASI DEALER
ASI-16-8U			332D-11 CALIBRATED GYROMOTOR ROTOR	ASI DEALER
ASI-16-8V			332D-11 MODIFIED DRILL BIT	ASI DEALER
ASI-16-8W			332D-11 PRELOAD SLEEVE REMOVER	ASI DEALER
ASI-16-8W1			332D-11 ROTOR DISASSEMBLY TOOLS	ASI DEALER
ASI-16-8W2			332D-11 MOUNT INSTALLATION BASE TOOL NO 1	ASI DEALER
ASI-16-8W3			332D-11 MOUNT INSTALLATION FLARING TOOL NO 1	ASI DEALER
ASI-16-8W4			332D-11 MOUNT INSTALLATION BASE TOOL NO 2	ASI DEALER
ASI-16-8W5			332D-11 MOUNT INSTALLATION FLARING TOOL NO 2	ASI DEALER
ASI-16-8X			332D-11 ARBOR PRESS PUNCH TOOL	ASI DEALER
ASI-16-8Y1			332D-11 DIAL INDICATOR MOUNTING POST INSPECTION NO 1 TOOL	ASI DEALER
ASI-16-8Y2			332D-11 DIAL INDICATOR MOUNTING POST INSPECTION NO 2 TOOL	ASI DEALER
ASI-16-8Y3			332D-11 DIAL INDICATOR MOUNTING POST INSPECTION NO 3 TOOL	ASI DEALER
ASI-16-8Y4			332D-11 DIAL INDICATOR MOUNTING POST CHECK NO 1 TOOL	ASI DEALER
ASI-16-8Y5			332D-11 DIAL INDICATOR MOUNTING POST CHECK NO 1 TOOL	ASI DEALER
ASI-16-8Z1			332D-11 PRESS ADAPTER PLATE (FOR DAKE MODEL 0)	ASI DEALER
ASI-16-8Z2			332D-11 GYROMOTOR SUPPORT FIXTURE (USE WITH DAKE MODEL 0)	ASI DEALER
ASI-16-9A		2034816-0001	TEST PLACARD	ASI DEALER
ASI-16-9B		2034816-0002	TEST PLACARD	ASI DEALER
ASI-16-9C		2034816-0003	TEST PLACARD	ASI DEALER
ASI-16-92A		3611841-0001	TEST PLACARD	ASI DEALER
ASI-17-0A		2035426-0002	TEST PLACARD	ASI DEALER
ASI-17-1A		2036958-0501	CABLE: ASI-171 (RDT-1A) TO RDR (W1)	ASI DEALER
ASI-17-1B		2036957-0501	CABLE: ASI-171 (RDT-1A) TO PPI (W2)	ASI DEALER
ASI-17-1C		2036959-0501	CABLE: ASI-171 (RDT-1A) TO SYN (W3)	ASI DEALER
ASI-17-1D			LOAD BOX: ASI-171 (RDT-1A) A1	ASI DEALER
ASI-17-2A		2037016-0501	CABLE: ASI-172 (RDT-1B) TO CON-1J/L/N (W102)	ASI DEALER
ASI-17-2B		2037018-0501	CABLE: ASI-172 (RDT-1B) TO ANT-1A/B/C/D/E/F/J/L/M/N/P/S (W201)	ASI DEALER
ASI-17-2C		2037015-0501	CABLE: ASI-172 (RDT-1B) TO CON-1A/B/D (W101)	ASI DEALER
ASI-17-2D		2037017-0501	CABLE: ASI-172 (RDT-1B) TO CON-1NB (W103)	ASI DEALER
ASI-17-2E		2037019-0501	CABLE: ASI-172 (RDT-1B) TO ANT-1G (W202)	ASI DEALER
ASI-17-3A			CABLE: ASI-173 (PPT-1A) W1	ASI DEALER
ASI-17-3B			CABLE: ASI-173 (PPT-1A) W2	ASI DEALER
ASI-17-4A		2038283-0501	CABLE: ASI-174 (PPT-1B) W101	ASI DEALER
ASI-17-4B		2038284-0501	CABLE: ASI-174 (PPT-1B) W102	ASI DEALER
ASI-17-4C		2038816-0501	CABLE: ASI-174 (PPT-1B) W103	ASI DEALER
ASI-17-5A		2034175-0002	TEST PLACARD	ASI DEALER
ASI-17-6A			CABLE: ASI-176 TO BDI-36	ASI DEALER
ASI-17-6B			CABLE: ASI-176 TO CLIFTON 59500000(-), 66000000(-)	ASI DEALER
ASI-17-6C			CABLE: ASI-176 TO 339F-8B, 339F-18/18F	ASI DEALER
ASI-17-6D			CABLE: ASI-176 TO 331A-6A, 331A-6P	ASI DEALER
ASI-17-6E			CABLE: ASI-176 TO 331A-6R	ASI DEALER
ASI-17-6F			CABLE: ASI-176 TO 331A-9G, HSI-45	ASI DEALER
ASI-17-6G			CABLE: ASI-176 TO 331A-8G	ASI DEALER
ASI-17-6H			CABLE: ASI-176 TO 339F-12, IND-40/41	ASI DEALER
ASI-17-6I			CABLE: ASI-176 TO 331A-8A, 331A-8D, 331A-8K	ASI DEALER
ASI-17-6J			CABLE: ASI-176 TO KDI-5700, KDI-5710, ARINC 568	ASI DEALER
ASI-17-6K			CABLE: ASI-176 TO 331A-8L	ASI DEALER
ASI-17-6L			CABLE: ASI-176 TO HSI-84	ASI DEALER

AVAILABILITY:

ASI DEALER: CONTACT ANY ASI DEALER FOR QUOTE
 COLLINS: CONTACT ROCKWELL COLLINS FOR QUOTE
 GABLES: CONTACT GABLES ENGINEERING FOR QUOTE
 TELEPHONICS: CONTACT TELEPHONICS FOR QUOTE

ASI SPECIALIZED TEST EQUIPMENT LIST

AVAILABILITY SUBJECT TO CHANGE WITHOUT NOTICE

<u>ASI MN</u>	<u>EQUIV MN</u>	<u>EQUIV PN</u>	<u>DESCRIPTION</u>	<u>AVAILABILITY</u>
ASI-17-6M			CABLE: ASI-176 TO RD-550/A/B/R	ASI DEALER
ASI-17-6N			CABLE: ASI-176 TO RD-500/A	ASI DEALER
ASI-17-6O			CABLE: ASI-176 TO COLLINS 331A-8D DME BOARDS	ASI DEALER
ASI-17-6P			CABLE: ASI-176 TO RD-600/A/B	ASI DEALER
ASI-17-6Q			CABLE: ASI-176 TO RD-650/A/B/R	ASI DEALER
ASI-17-6R			CABLE: ASI-176 TO ASTRONAUTICS 125810	ASI DEALER
ASI-17-6S			CABLE: ASI-176 TO KING KPI-553 INDICATOR	ASI DEALER
ASI-17-61H			CABLE: ASI-176-1 TO 339F-12, IND-40, IND-41	ASI DEALER
ASI-17-61J			CABLE: ASI-176-1 TO CLIFTON 660 (66000000-1)	ASI DEALER
ASI-17-7A		2037543-0501	CABLE: ASI-177-1 (RNT-26A) W105	ASI DEALER
ASI-17-7B		2037550-0501	CABLE: ASI-177-1 (RNT-26A) W109	ASI DEALER
ASI-17-7C		2037551-0501	CABLE: ASI-177-1 (RNT-26A) W110	ASI DEALER
ASI-17-7D		2037547-0501	CABLE: ASI-177-1 (RNT-26A) W111	ASI DEALER
ASI-17-7E		2037549-0501	CABLE: ASI-177-1 (RNT-26A) W112	ASI DEALER
ASI-17-7F		2037544-0501	CABLE: ASI-177-1 (RNT-26A) W113	ASI DEALER
ASI-17-7G		2037546-0501	CABLE: ASI-177-1 (RNT-26A) W114	ASI DEALER
ASI-17-7H		2037545-0501	CABLE: ASI-177-1 (RNT-26A) W115	ASI DEALER
ASI-17-7I		2037552-0501	CABLE: ASI-177-1 (RNT-26A) W116	ASI DEALER
ASI-17-7J		2037551-0502	CABLE: ASI-177-1 (RNT-26A) W117	ASI DEALER
ASI-17-7K		2037548-0501	CABLE: ASI-177-1 (RNT-26A) W118	ASI DEALER
ASI-17-7L			LOAD, ASI-177-1 (RNT-26A) A2	ASI DEALER
ASI-17-7M			LOAD, ASI-177-1 (RNT-26A) A3	ASI DEALER
ASI-17-7N		2037553-0501	LOAD: ASI-177-1 (RNT-26A) PR1	ASI DEALER
ASI-17-7P			CABLE: ASI-177-1 (RNT-26A) W103	ASI DEALER
ASI-17-7Q			CABLE: ASI-177-1 (RNT-26A) W121	ASI DEALER
ASI-17-7R			CABLE: ASI-177-1 (RNT-26A) W104	ASI DEALER
ASI-17-72A		3604050-0501	CABLE: ASI-177-2 (RNT-260A) TO R-2032 / R-2325 (W12)	ASI DEALER
ASI-17-72B		3604049-0501	CABLE: ASI-177-2 (RNT-260A) TO CONTROL (W11)	ASI DEALER
ASI-17-72C		3604380-0501	CABLE: POWER (W13)	ASI DEALER
ASI-17-72D		3604357-0501	CABLE: GS COAX	ASI DEALER
ASI-17-72D1		3604357-0504	CABLE: GS COAX	ASI DEALER
ASI-17-72E		3604357-0502	CABLE: VOR/LOC COAX	ASI DEALER
ASI-17-72E1		3604357-0505	CABLE: VOR/LOC COAX	ASI DEALER
ASI-17-72F		3604357-0503	CABLE: MB COAX	ASI DEALER
ASI-17-72F1		3604357-0506	CABLE: MB COAX	ASI DEALER
ASI-17-72G		3604322-0501	CABLE: ASI-177-2 (RNT-260A) TO R-2023 / R-2139	ASI DEALER
ASI-17-72H		3604321-0501	CABLE: ASI-177-2 (RNT-260A) TO C-10048 / C-10049	ASI DEALER
ASI-17-72J			BENCH MOCK-UP: ASI-177-2 (RNT-260 /-6001) TO R-2325(V)/ARN-147(V) (VIR-130A)	ASI DEALER
ASI-17-72K		687-4041-001	1553 BUS ADAPTER: VIR-130A TO ALTANTIS DCM-1553	ASI DEALER
ASI-17-72L			CABLE: ASI-177-2 (RNT-260A) TO R-1963	ASI DEALER
ASI-17-8A			CABLE: ASI-178 (477Q-1/1A) TO 331A-3F/3G	ASI DEALER
ASI-17-8B			CABLE: ASI-178 (477Q-1/1A) TO 331A-6D	ASI DEALER
ASI-17-8C			CABLE: ASI-178 (477Q-1/1A) TO ASI-166 (479X-2)	ASI DEALER
ASI-17-8D			CABLE: ASI-178 (477Q-1/1A) TO ASI-142-1 (477L-1)	ASI DEALER
ASI-17-9A			CABLE: ASI-179 (476E-7) TO 332E-4	ASI DEALER
ASI-18-1A		791-8153-001	CABLE: ASI-181 (975D-1) TO 860E-3	ASI DEALER
ASI-18-2A		635-5775-001	CABLE: ASI-182 (975D-2) TO ARINC 521 DME (W2)	ASI DEALER
ASI-18-2B		635-5774-001	CABLE: ASI-182 (975D-2) TO ARINC 568 DME (W3)	ASI DEALER
ASI-18-2C		635-5791-001	CABLE: ASI-182 (975D-2) TO SQUAWK NAUT (W4)	ASI DEALER
ASI-18-2D		635-5795-001	CABLE: ASI-182 (975D-2) TO DME 40 (W5)	ASI DEALER
ASI-18-2E			SUPPRESSOR LOAD BOX FOR 860E-3/4/5	ASI DEALER
ASI-18-2F			FAULT MONITOR (A8) TEST FIXTURE FOR 860E-5	ASI DEALER
ASI-18-2G		791-8381-001	TUBE EXTENDER A FOR 860E-3	ASI DEALER
ASI-18-2H		791-8390-001	TUBE EXTENDER B FOR 860E-3	ASI DEALER
ASI-18-2I			CABLE: SPECIAL DRIVER INPUT FOR 860E-3	ASI DEALER
ASI-18-2J			CABLE: SPECIAL SYNTHESIZER OUTPUT FOR 860E-3	ASI DEALER
ASI-18-3A		629-0001-001	CABLE: ASI-183 (971F-1) GYRO SIMULATOR CABLE (W1)	ASI DEALER
ASI-18-3B		629-0002-001	CABLE: ASI-183 (971F-1) TO 562C-5() (W2)	ASI DEALER
ASI-18-3C		629-0005-001	CABLE: ASI-183 (971F-1) TO 161E-2A (W5)	ASI DEALER
ASI-18-3D		629-0006-001	CABLE: ASI-183 (971F-1) TO 614E-5A (W6)	ASI DEALER
ASI-18-3E		629-0007-001	CABLE: ASI-183 (971F-1) TO 562C-5() (W7)	ASI DEALER
ASI-18-3F		629-0009-001	CABLE: ASI-183 (971F-1) TO 562C-8 (W9)	ASI DEALER
ASI-18-3G		629-0010-001	CABLE: ASI-183 (971F-1) TO 562C-5() (W10)	ASI DEALER
ASI-18-3H		629-9007-001	CABLE: ASI-183 (971F-1) TO 562C-8F/G (W11)	ASI DEALER
ASI-18-3I		629-9008-001	CABLE: ASI-183 (971F-1) TO 562C-8F (W12)	ASI DEALER
ASI-18-3J		634-9299-001	CABLE: ASI-183 (971F-1) TO 562C-8F (W13)	ASI DEALER
ASI-18-3K		634-9668-001	CABLE: ASI-183 (971F-1) TO 562C-8() (W14)	ASI DEALER
ASI-18-3L		634-2714-001	CABLE: ASI-183 (971F-1) TO 562C-8G (W15)	ASI DEALER
ASI-18-5A		629-9558-001	CABLE: ASI-185 (970G-1) TO 332C-10	ASI DEALER

AVAILABILITY:

ASI DEALER: CONTACT ANY ASI DEALER FOR QUOTE
 COLLINS: CONTACT ROCKWELL COLLINS FOR QUOTE
 GABLES: CONTACT GABLES ENGINEERING FOR QUOTE
 TELEPHONICS: CONTACT TELEPHONICS FOR QUOTE

ASI SPECIALIZED TEST EQUIPMENT LIST

AVAILABILITY SUBJECT TO CHANGE WITHOUT NOTICE

<u>ASI MN</u>	<u>EQUIV MN</u>	<u>EQUIV PN</u>	<u>DESCRIPTION</u>	<u>AVAILABILITY</u>
ASI-18-5B		629-9557-001	CABLE: ASI-185 (970G-1) TO RMI-36	ASI DEALER
ASI-18-5C		687-7902-001	CABLE: ASI-185 (970G-1) TO ANT-60B/462B (ADF-60 FIG 10-2, ADF-462 FIG 5-14)	ASI DEALER
ASI-18-5D			CABLE: ASI-185 (970G-1) TO ASI-61 ADF ANT SIMULATOR	ASI DEALER
ASI-18-7A			CABLE: ASI-187 (970E-1) TO ASI-167 (978F-2S)	ASI DEALER
ASI-18-7B			CABLE: ASI-187 (970E-1) TO 332C-4	ASI DEALER
ASI-18-7C			CABLE: ASI-187 (970E-1) TO 332C-8	ASI DEALER
ASI-18-7D			CABLE: ASI-187 (970E-1) TO RMI-30, 332C-10	ASI DEALER
ASI-18-7E			CABLE: ASI-187 (970E-1) TO 332C-10B	ASI DEALER
ASI-18-7F			CABLE: ASI-187 (970E-1) TO RMI-36. BDI-36	ASI DEALER
ASI-18-8A			CABLE: ASI-188 TO WXT-XXX R/T	ASI DEALER
ASI-18-8B			CABLE: ASI-188 TO IND-XXX INDICATOR	ASI DEALER
ASI-18-8C			CABLE: ASI-188 TO ANT-XXX ANTENNA	ASI DEALER
ASI-18-8D			CABLE: ASI-188 TO DCP-270/300/325 DISPLAY CONTROL PANEL-J2	ASI DEALER
ASI-18-8E1			CABLE: ASI-188 TO WXP-85C/D	ASI DEALER
ASI-18-8E2			CABLE: ASI-188 TO WXP-85A	ASI DEALER
ASI-18-8E3			CABLE: ASI-188 TO WXP-85B	ASI DEALER
ASI-18-8F			CABLE: ASI-188 TO DCP-270/300	ASI DEALER
ASI-18-8G			CABLE: WXA-85 TEST CABLE 1	ASI DEALER
ASI-18-8H			CABLE: WXA-85 TEST CABLE 2	ASI DEALER
ASI-81-82B			CABLE: ASI-818-2 TO PC-17/PC-17-1/PC-17-2/PC-17-3()/SPC-60/SPC-60A/SPC-60C	ASI DEALER
ASI-81-82C			CABLE: ASI-818-2 TO PC-17-3C	ASI DEALER
ASI-18-83A			CABLE: ASI-818-3 TO PC-250/PC-250-2A/PC-251/PC-251-5B	ASI DEALER
ASI-18-83B			CABLE: ASI-818-3 TO PC-250-1A	ASI DEALER
ASI-18-83C			CABLE: ASI-818-3 TO PC-250-1B	ASI DEALER
ASI-18-83D			CABLE: ASI-818-3 TO PC-250-1C/PC-251-1C	ASI DEALER
ASI-18-83E			CABLE: ASI-818-3 TO PC-250-1D/PC-251-5C	ASI DEALER
ASI-18-83F			CABLE: ASI-818-3 TO PC-251-3A	ASI DEALER
ASI-18-83G			CABLE: ASI-818-3 TO PC-251-3B	ASI DEALER
ASI-18-83H			CABLE: ASI-818-3 TO PC-251-5A	ASI DEALER
ASI-18-83J			CABLE: ASI-818-3 TO PC-251-15A/PC-251-15B/PC-251-15C	ASI DEALER
ASI-18-83K			CABLE: ASI-818-3 TO PC-251-123A	ASI DEALER
ASI-18-83L			CABLE: ASI-818-3 TO PC-251-123B	ASI DEALER
ASI-18-83M			CABLE: ASI-818-3 TO PC-251-123B(MODC)/PC-251-123E	ASI DEALER
ASI-18-83N			CABLE: ASI-818-3 TO PC-251-123C	ASI DEALER
ASI-18-83P			CABLE: ASI-818-3 TO PC-251-123D	ASI DEALER
ASI-18-83Q			CABLE: ASI-818-3 TO PC-251-123F	ASI DEALER
ASI-18-83R			CABLE: ASI-818-3 TO PC-251-123J/PC-251-123J2/PC-251-123JA	ASI DEALER
ASI-18-83S			CABLE: ASI-818-3 TO PC-350/PC-350-1B/PC-350-2A/PC-350-4A/PC-350-34A	ASI DEALER
ASI-18-83T			CABLE: ASI-818-3 TO PC-350-1A	ASI DEALER
ASI-18-9A		622-6454-002	SVO-65/75 MODIFICATION KIT FOR ASI-212-3 (960M-3)	ASI DEALER
ASI-18-9B		634-2835-001	SMT-65() CAPSTAN HOLDING FIXTURE	ASI DEALER
ASI-18-9C		634-2830-001	SMT-65E CAPSTAN HOLDING FIXTURE	ASI DEALER
ASI-18-9D			MAGNETIC CLUTCH HOLDING FIXTURE	ASI DEALER
ASI-18-9E		647-3825-001	BACKLASH TEST FIXTURE	ASI DEALER
ASI-18-9F		E71737	SMT-65 GEAR STOP TOOL	ASI DEALER
ASI-19-2A		549-6540-003	CABLE: ASI-192 (477U-2) SENSE CABLE	ASI DEALER
ASI-19-2B		544-5037-002	CABLE: ASI-192 (477U-2) RF SIM CABLE	ASI DEALER
ASI-19-2C		549-6545-004	CABLE: ASI-192 (477U-2) LOOP ANT CABLE	ASI DEALER
ASI-19-2D		554-6109-004	CABLE: ASI-192 (477U-2) LOW CAP SENSE ADAPTER CABLE	ASI DEALER
ASI-19-3A		549-6544-004	CABLE: ASI-193 (477V-2) RECEIVER POWER CABLE	ASI DEALER
ASI-19-3B		549-6543-004	CABLE: ASI-193 INDICATOR POWER CABLE	ASI DEALER
ASI-19-4A			CABLE: ASI-194 TO 860F-1/4 P1B	ASI DEALER
ASI-19-4B			CABLE: ASI-194 TO 860F-1/4 J9	ASI DEALER
ASI-19-4C			CABLE: ASI-194 TO 339H-()	ASI DEALER
ASI-19-4D			CABLE: 860F-4 15 PIN EXTENDER	ASI DEALER
ASI-19-5A			CABLE: ASI-195 TO PS-823()	ASI DEALER
ASI-19-6A			CABLE: ASI-196 (SN 104 AND ABOVE) TO PS-835()	ASI DEALER
ASI-19-6B			CABLE: ASI-196 TO A2 PCB	ASI DEALER
ASI-19-9A		2037536-0501	CABLE: ASI-199 (ALT-51A) W101	ASI DEALER
ASI-19-9B		2037533-0501	CABLE: ASI-199 (ALT-51A) W102	ASI DEALER
ASI-19-9C		2037517-0501	CABLE: ASI-199 (ALT-51A) W103	ASI DEALER
ASI-19-9D		2037535-0501	CABLE: ASI-199 (ALT-51A) W104	ASI DEALER
ASI-19-9E		2037554-0501	CABLE: ASI-199 (ALT-51A) W105	ASI DEALER
ASI-19-9F		2068253-0701	CABLE: ASI-199 (ALT-51A) W113	ASI DEALER
ASI-19-9G		2038137-0007	CABLE: ASI-199 (ALT-51A) W112	ASI DEALER
ASI-19-9H		2038137-0008	CABLE: ASI-199 (ALT-51A) W114	ASI DEALER
ASI-19-9I		2037075-0501	EXT CARD: ASI-199 (ALT-51A) NARROW	ASI DEALER
ASI-19-9J		2037075-0502	EXT CARD: ASI-199 (ALT-51A) WIDE	ASI DEALER
ASI-19-9K		TT-1241	ALA-51A STRIPLINE TEST ADAPTER	ASI DEALER

AVAILABILITY:

ASI DEALER: CONTACT ANY ASI DEALER FOR QUOTE
 COLLINS: CONTACT ROCKWELL COLLINS FOR QUOTE
 GABLES: CONTACT GABLES ENGINEERING FOR QUOTE
 TELEPHONICS: CONTACT TELEPHONICS FOR QUOTE

ASI SPECIALIZED TEST EQUIPMENT LIST

AVAILABILITY SUBJECT TO CHANGE WITHOUT NOTICE

<u>ASI MN</u>	<u>EQUIV MN</u>	<u>EQUIV PN</u>	<u>DESCRIPTION</u>	<u>AVAILABILITY</u>
ASI-19-9L		TT-3-2037042	ALA-51A CENTER CONDUCTOR ALIGNMENT TOOL	ASI DEALER
ASI-19-9M		TT-6-2037042	ALA-51A CENTER CONDUCTOR ALIGNMENT RING	ASI DEALER
ASI-19-9N			ALA-51A TRANSMITTER EXTENDER CABLE	ASI DEALER
ASI-19-9P			ALA-51A TRANSMITTER TEST CONNECTOR	ASI DEALER
ASI-19-11A			SPECIAL TEST CABLE, ADI-84 / 329B-7R	ASI DEALER
ASI-19-11B			ADAPTER CABLE: ADI-84()	ASI DEALER
ASI-19-61A	JF-380A	570-7997-01	CABLE: ASI-196-1 TO PS-850() / PS-855()	ASI DEALER
ASI-20-01A			CABLE: ASI-401-ISA J1 TO CTC-429 J10	ASI DEALER
ASI-20-01B			CABLE: ASI-401-ISA J33 TO CTC-429 J12	ASI DEALER
ASI-20-01C			CABLE: ASI-401-ISA J32 TO CTC-429 J14	ASI DEALER
ASI-20-01D1			CABLE: ASI-401-ISA J2 EXTENDER	ASI DEALER
ASI-20-01D2			CABLE: ASI-401-ISA J3 EXTENDER	ASI DEALER
ASI-20-01D3			CABLE: ASI-401-ISA J4 EXTENDER	ASI DEALER
ASI-20-01D4			CABLE: ASI-401-ISA J5 EXTENDER	ASI DEALER
ASI-20-01D5			CABLE: ASI-401-ISA J6 EXTENDER	ASI DEALER
ASI-20-01D6			CABLE: ASI-401-ISA J7/J8 EXTENDER	ASI DEALER
ASI-20-01D7			CABLE: ASI-401-ISA J11 EXTENDER	ASI DEALER
ASI-20-01D8			CABLE: ASI-401-ISA J12 EXTENDER	ASI DEALER
ASI-20-01D9			CABLE: ASI-401-ISA J14 EXTENDER	ASI DEALER
ASI-20-01E			TEST PLUG: ASI-401-ISA J13 ARINC 429	ASI DEALER
ASI-20-01F			RACKMOUNT COMPUTER MONITOR FOR ASI-2001 (LCD)	ASI DEALER
ASI-20-1A		762-1551-002	CABLE: ASI-201-2 (477U-3) RF INPUT (W2)	ASI DEALER
ASI-20-1B		762-1561-002	CABLE: ASI-201-2 (477U-3) INVERTER SERVICING (W4)	ASI DEALER
ASI-20-1C		549-6545-004	CABLE: ASI-201-2 (477U-3) LOOP ANTENNA (W3)	ASI DEALER
ASI-20-1D		762-1667-002	CABLE: ASI-201-2 (477U-3) LOW CAP SENSE ANT ADAPTER	ASI DEALER
ASI-20-1E		762-1499-004	TEST FIXTURE: ASI-201-2 (477U-3) ADF LOOP ANTENNA	ASI DEALER
ASI-20-1F		762-1496-002	CABLE: ASI-201-2 (477U-3) POWER (W1)	ASI DEALER
ASI-20-2A		2064756-0501	CABLE: ASI-202 (DFT-73AA) W101	ASI DEALER
ASI-20-2B		2065211-0501	CABLE: ASI-202 (DFT-73AA) W102	ASI DEALER
ASI-20-2C		2064754-0501	CABLE: ASI-202 (DFT-73AA) W103	ASI DEALER
ASI-20-2D		2065171-0501	CABLE: ASI-202 (DFT-73AA) TO CNA-73CB/FC/FD CONTROL	ASI DEALER
ASI-20-2E		2065171-0502	CABLE: ASI-202 (DFT-73AA) TO CNA-73FB CONTROL	ASI DEALER
ASI-20-3A			CABLE: ASI-203 (980N-1) DUAL ADAPTER	ASI DEALER
ASI-20-3B			CABLE: ASI-203 (980N-1) TRIPLEX ADAPTER	ASI DEALER
ASI-20-3C			CABLE: ASI-203 DUAL SYSTEM RAMP TESTER	ASI DEALER
ASI-20-4XA			CABLE: J101 EXTENDER FOR ASI-204 OR 972S-1 (CUSTOM LENGTH)	ASI DEALER
ASI-20-4XB			CABLE: J102 EXTENDER FOR ASI-204 OR 972S-1 (CUSTOM LENGTH)	ASI DEALER
ASI-20-4XC			CABLE: J103 EXTENDER FOR ASI-204 OR 972S-1 (CUSTOM LENGTH)	ASI DEALER
ASI-20-4XD			CABLE: J104 EXTENDER FOR ASI-204 OR 972S-1 (CUSTOM LENGTH)	ASI DEALER
ASI-20-4XE			CABLE: 562C-13 EXTENDER FOR ASI-204 OR 972S-1 (CUSTOM LENGTH)	ASI DEALER
ASI-20-6A			334C-9/9A/11 SERVO RUN-IN FIXTURE	ASI DEALER
ASI-20-6B			334C-9/9A/11 CAPSTAN ANGLE INDICATOR	ASI DEALER
ASI-20-7A		617-9756-001	CABLE: ASI-207-2 (678P-5) J4 TO 490S-1 J1 (W1)	ASI DEALER
ASI-20-7B		617-9758-001	CABLE: ASI-207-2 (678P-5) J3 TO 490S-1 J3 (W2)	ASI DEALER
ASI-20-7C		617-9755-001	CABLE: ASI-207-2 (678P-5) J2 TO 618T-() P40 (W3)	ASI DEALER
ASI-20-7D		618-7711-001	CABLE: 618T-() TO WATTMETER (W4)	ASI DEALER
ASI-20-7E		618-7712-001	CABLE: 490S-1 J2 TO WATTMETER (W5)	ASI DEALER
ASI-20-7F		617-9743-001	CABLE: DC SUPPLY TO J35	ASI DEALER
ASI-20-7G		757-8979-001	CABLE: AC SUPPLY TO J36	ASI DEALER
ASI-20-7H			TRANSMITTER GAIN CONTROL	ASI DEALER
ASI-20-9A		548-8002-004	CABLE: ASI-209 TO 618T-1/2/3 (W3)	ASI DEALER
ASI-20-9A1		548-8002-005	CABLE: ASI-209 TO 618T-1/2/3 (W3)	ASI DEALER
ASI-20-9B		548-8003-004	CABLE: ASI-209 TO 516H-1 (W4)	ASI DEALER
ASI-20-9B1		548-8003-005	CABLE: ASI-209 TO 516H-1 (W4)	ASI DEALER
ASI-20-9C		548-8023-003	CABLE: ASI-209 TO DC PWR (W5)	ASI DEALER
ASI-20-9C1		548-8023-004	CABLE: ASI-209 TO DC PWR (W5)	ASI DEALER
ASI-20-9D		548-8025-003	CABLE: ASI-209 TO AC PWR (W6)	ASI DEALER
ASI-20-9D1		548-8025-004	CABLE: ASI-209 TO AC PWR (W6)	ASI DEALER
ASI-20-9E		548-8029-004	CABLE: ASI-209 TO 714E-1/2 (W7)	ASI DEALER
ASI-20-9E1		548-8029-005	CABLE: ASI-209 TO 714E-1/2 (W7)	ASI DEALER
ASI-20-9F		548-8284-004	CABLE: ASI-209 TO 714E-3/6 (W8)	ASI DEALER
ASI-20-9F1		548-8284-005	CABLE: ASI-209 TO 714E-3/6 (W8)	ASI DEALER
ASI-20-9G		548-8285-004	CABLE: ASI-209 TO 309A-1 (W9)	ASI DEALER
ASI-20-9G1		548-8285-005	CABLE: ASI-209 TO 309A-1 (W9)	ASI DEALER
ASI-20-9H		548-8286-004	CABLE: ASI-209 TO 309A-2D (W10)	ASI DEALER
ASI-20-9H1		548-8286-005	CABLE: ASI-209 TO 309A-2D (W10)	ASI DEALER
ASI-20-9J		548-8287-004	CABLE: ASI-209 TO 180L-2/3 (W11)	ASI DEALER
ASI-20-9J1		548-8287-005	CABLE: ASI-209 TO 180L-2/3 (W11)	ASI DEALER
ASI-20-9K		549-4334-002	CABLE: RF (W12)	ASI DEALER

AVAILABILITY:

ASI DEALER: CONTACT ANY ASI DEALER FOR QUOTE
 COLLINS: CONTACT ROCKWELL COLLINS FOR QUOTE
 GABLES: CONTACT GABLES ENGINEERING FOR QUOTE
 TELEPHONICS: CONTACT TELEPHONICS FOR QUOTE

ASI SPECIALIZED TEST EQUIPMENT LIST

AVAILABILITY SUBJECT TO CHANGE WITHOUT NOTICE

ASI MN	EQUIV MN	EQUIV PN	DESCRIPTION	AVAILABILITY
ASI-20-9K1		549-4334-003	CABLE: RF (W12)	ASI DEALER
ASI-20-9L		554-2915-004	CABLE: ASI-209 TO CU-351 (W13)	ASI DEALER
ASI-20-9L1		554-2915-005	CABLE: ASI-209 TO CU-351 (W13)	ASI DEALER
ASI-20-9M		757-1377-001	CABLE: ASI-209 TO 490T-1/1A (W18)	ASI DEALER
ASI-20-9M1		757-1377-002	CABLE: ASI-209 TO 490T-1/1A (W18)	ASI DEALER
ASI-20-9N		761-4971-001	CABLE: ASI-209 TO 490B-1 (W14)	ASI DEALER
ASI-20-9N1		761-4971-002	CABLE: ASI-209 TO 490B-1 (W14)	ASI DEALER
ASI-20-9P		761-4970-001	CABLE: ASI-209 TO 313V-1 (W15)	ASI DEALER
ASI-20-9P1		761-4970-002	CABLE: ASI-209 TO 313V-1 (W15)	ASI DEALER
ASI-20-9Q		756-5248-004	CABLE: ASI-209 TO 488A-2 (W16)	ASI DEALER
ASI-20-9Q1		756-5248-005	CABLE: ASI-209 TO 488A-2 (W16)	ASI DEALER
ASI-20-9R		761-4969-001	CABLE: ASI-209 TO DC PWR (W17)	ASI DEALER
ASI-20-9R1		761-4969-002	CABLE: ASI-209 TO DC PWR (W17)	ASI DEALER
ASI-20-11A	CG-2794	762-1551-001	CABLE: ASI-201-1 (AN/ARM-93) RF INPUT	ASI DEALER
ASI-20-11B	CX-115711	762-1561-001	CABLE: ASI-201-1 (AN/ARM-93) INVERTER SERVICING	ASI DEALER
ASI-20-11C	CX-11570	549-6545-004	CABLE: ASI-201-1 (AN/ARM-93) LOOP ANTENNA	ASI DEALER
ASI-20-11D	SM-446	762-1667-001	CABLE: ASI-201-1 (AN/ARM-93) LOW CAP SENSE ANT ADAPTER	ASI DEALER
ASI-20-11E	MT-3667	762-1499-003	TEST FIXTURE: ASI-201-1 (AN/ARM-93) ADF LOOP ANTENNA	ASI DEALER
ASI-20-11F	CX-11569	762-1496-001	CABLE: ASI-201-1 (AN/ARM-93) POWER	ASI DEALER
ASI-20-74A		988-5561-001	CABLE: ASI-207-4 (967R-2) SPECIAL PURPOSE	ASI DEALER
ASI-20-74B		988-5562-001	CABLE: ASI-207-4 (967R-2) SPECIAL PURPOSE	ASI DEALER
ASI-20-74C		988-5563-001	CABLE: ASI-207-4 (967R-2) SPECIAL PURPOSE	ASI DEALER
ASI-20-74D		988-5564-001	CABLE: ASI-207-4 (967R-2) SPECIAL PURPOSE	ASI DEALER
ASI-20-74E		988-5565-001	CABLE: ASI-207-4 (967R-2) SPECIAL PURPOSE	ASI DEALER
ASI-20-74F		988-5566-001	CABLE: ASI-207-4 (967R-2) SPECIAL PURPOSE	ASI DEALER
ASI-20-74G1		988-5567-001	CABLE: ASI-207-4 (967R-2) SPECIAL PURPOSE	ASI DEALER
ASI-20-74G2		988-5567-002	CABLE: ASI-207-4 (967R-2) SPECIAL PURPOSE	ASI DEALER
ASI-20-74H		988-5568-001	CABLE: ASI-207-4 (967R-2) SPECIAL PURPOSE	ASI DEALER
ASI-20-74J		988-5569-001	CABLE: ASI-207-4 (967R-2) SPECIAL PURPOSE	ASI DEALER
ASI-20-74K		988-5570-001	CABLE: ASI-207-4 (967R-2) SPECIAL PURPOSE	ASI DEALER
ASI-20-74L		988-5571-001	CABLE: ASI-207-4 (967R-2) SPECIAL PURPOSE	ASI DEALER
ASI-20-74M1		988-5572-001	CABLE: ASI-207-4 (967R-2) SPECIAL PURPOSE	ASI DEALER
ASI-20-74M2		988-5572-002	CABLE: ASI-207-4 (967R-2) SPECIAL PURPOSE	ASI DEALER
ASI-20-74N			CABLE: ASI-207-4 (967R-2) SPECIAL TEST CONNECTOR FOR MANUAL SELF TESTS	ASI DEALER
ASI-20-76A			CABLE: RIBBON W1	ASI DEALER
ASI-20-76B			CABLE: TEST PIN (W2)	ASI DEALER
ASI-20-76C1			TEST COVER: TOP	ASI DEALER
ASI-20-76C2			TEST COVER: COVER	ASI DEALER
ASI-20-76C3			TEST COVER: BOTTOM	ASI DEALER
ASI-20-76D1			PLUG ASSY: 0.515"	ASI DEALER
ASI-20-76D2			PLUG ASSY: 0.559"	ASI DEALER
ASI-20-76E			PLUG ASSY: RIGHT ANGLE	ASI DEALER
ASI-20-82A		608-9941-001	CABLE: ASI-208 (980H-5) POWER CABLE	ASI DEALER
ASI-20-83A		617-9770-001	CABLE: ASI-208-3 (878L-39) W1 CABLE	ASI DEALER
ASI-20-84A		609-9433-001	CABLE: ASI-208-4 (878L-40) W1 CABLE	ASI DEALER
ASI-20-84B		609-9459-001	CABLE: ASI-208-4 (878L-40) W2 CABLE	ASI DEALER
ASI-20-84C		609-9487-001	CABLE: ASI-208-4 (878L-40) W3 CABLE	ASI DEALER
ASI-20-84D			EXTENDER CARD: 490S-1 A4	ASI DEALER
ASI-20-84E			EXTENDER CARD: 490S-1 A5	ASI DEALER
ASI-20-84F			EXTENDER CARD: 490S-1 A6	ASI DEALER
ASI-20-84G			EXTENDER CARD: 490S-1 A7	ASI DEALER
ASI-21-3A			CABLE: ASI-213 TO 334C-6/SVO-80	ASI DEALER
ASI-21-3B		628-5151-001	SERVO MOUNT HOLDING FIXTURE (351B-6J/K/L/M/ ONLY)	ASI DEALER
ASI-21-3C		608-3945-001	SERVO MOUNT HOLDING FIXTURE (EXCEPT 351B-6J/K/L/M)	ASI DEALER
ASI-21-3D		608-4005-001	ADAPTER HUB	ASI DEALER
ASI-21-3E		608-4006-001	SPANNER WRENCH	ASI DEALER
ASI-21-3F		608-4699-001	BACKLASH TEST FIXTURE (25-241J DIAL INDICATOR REQUIRED BUT NOT INCLUDED)	ASI DEALER
ASI-21-3G			PIN REMOVAL FXTURE (334C-6 MAN FIG 1011)	ASI DEALER
ASI-21-4A			ASI-214 TEST KIT FOR THE CTL-92/92A	ASI DEALER
ASI-21-4B			ASI-214 TEST KIT FOR THE CTL-92T	ASI DEALER
ASI-21-4C			ASI-214 TEST KIT FOR THE RTU-870A/T	ASI DEALER
ASI-21-4D			ASI-214 TEST KIT FOR THE TTC-920G	ASI DEALER
ASI-21-5A			CABLE: ASI-215 TO ASI-140, 160, 160B, 160C	ASI DEALER
ASI-21-5B			CABLE: ASI-215 TO ASI-150, 160, 160B, 160C, 190, 190B	ASI DEALER
ASI-21-5C			CABLE: ASI-215 TO ASI-200-2A/2B SYNCHRO CAL	ASI DEALER
ASI-21-5D			CABLE: ASI-215 TO ASI-200-2B RESOLVER CAL	ASI DEALER
ASI-21-7A			CABLE: ASI-217 TO CTL-22	ASI DEALER
ASI-21-8A			CABLE: ASI-218 TO DRI-55	ASI DEALER
ASI-21-8B			CABLE: CIRCUIT ANALYSIS	ASI DEALER

AVAILABILITY:

ASI DEALER: CONTACT ANY ASI DEALER FOR QUOTE
 COLLINS: CONTACT ROCKWELL COLLINS FOR QUOTE
 GABLES: CONTACT GABLES ENGINEERING FOR QUOTE
 TELEPHONICS: CONTACT TELEPHONICS FOR QUOTE

ASI SPECIALIZED TEST EQUIPMENT LIST

AVAILABILITY SUBJECT TO CHANGE WITHOUT NOTICE

<u>ASI MN</u>	<u>EQUIV MN</u>	<u>EQUIV PN</u>	<u>DESCRIPTION</u>	<u>AVAILABILITY</u>
ASI-21-8C			CABLE: ONE TO ONE	ASI DEALER
ASI-21-24A		634-1773-001	CAPSTAN TORQUE ADJUSTMENT FIXTURE (INCLUDED WITH ASI-212-4)	ASI DEALER
ASI-21-24B		634-1773-002	CAPSTAN TORQUE ADJUSTMENT FIXTURE	ASI DEALER
ASI-21-24C		634-1723-001	CAPSTAN AJJUSTMENT WRENCH (SUPPLIED WITH ASI-21-24A AND ASI-21-24B)	ASI DEALER
ASI-22-1A			CABLE: ASI-221 (968Y-1) TO 332C-4	ASI DEALER
ASI-22-1B			CABLE: ASI-221 (968Y-1) TO ASI-190/190B/160C	ASI DEALER
ASI-22-1C			CABLE: ASI-221 TO 51RV-2B TEST CONNECTOR	ASI DEALER
ASI-22-1D			CABLE: ASI-221 TO 51RV-4/5 TEST CONNECTOR	ASI DEALER
ASI-22-1E			CABLE: ASI-221 TO ASI-161 / 479V-3	ASI DEALER
ASI-22-1F			N1/N2 DC SOURCE (51RV-4/5 MAN FIG 910-911)	ASI DEALER
ASI-22-1G			CABLE: A18/A19 EXTENSION	ASI DEALER
ASI-22-2A			CABLE: ASI-222-1 TO 346D-1/2	ASI DEALER
ASI-22-3A			RF DETECTOR/AMP FOR ASI-223/478A-3/78A-3 (REPLACED BY ASI-22-3A1)	ASI DEALER
ASI-22-3A1		01-0817-00	RF DETECTOR/AMP FOR ASI-223/478A-3/78A-3/NAV-2000R (REPLACES ASI-22-3A)	ASI DEALER
ASI-22-4A		621-8134-001	CABLE: ASI-224 (972V-1) CONTROL / W1	ASI DEALER
ASI-22-4B		621-8132-001	CABLE: ASI-224 (972V-1) RT / W2	ASI DEALER
ASI-22-4C		621-8133-001	CABLE: ASI-224 (972V-1) TACAN ADAPTER / W3	ASI DEALER
ASI-22-4D		621-8164-001	CABLE: ASI-224 (972V-1) EXTERNAL HSI / W4	ASI DEALER
ASI-22-4E		621-8135-002	CABLE: ASI-224 (972V-1) RT AGE / W5	ASI DEALER
ASI-22-4F		621-8143-001	CABLE: ASI-224 (972V-1) AC POWER / W6	ASI DEALER
ASI-22-4G		621-8144-001	CABLE: ASI-224 (972V-1) INTERNAL HSI / W7	ASI DEALER
ASI-22-6A			CABLE: ASI-224 (972V-1) TO 331A-8H (42")	ASI DEALER
ASI-22-6A1		629-9202-001	CABLE: ASI-224 (972V-1) TO 331A-8H (8")	ASI DEALER
ASI-22-6A2		629-9202-002	CABLE: ASI-224 (972V-1) TO 331A-8H (48")	ASI DEALER
ASI-22-6B			CABLE: ASI-224 (972V-1) TO AQU-6/A	ASI DEALER
ASI-22-6C			CABLE: ASI-224 (972V-1) TO ID-250/ARN / 339D-1 / ID-1347/ARN-82	ASI DEALER
ASI-22-6D			CABLE: ASI-224 (972V-1) TO ID-1103 BDHI / ID-387/ARN	ASI DEALER
ASI-22-11A			CABLE: ASI-221-1 TO UUT	ASI DEALER
ASI-22-11B			CABLE: ASI-221-1 TO 32 PIN TEST CONNECTOR	ASI DEALER
ASI-22-11C			CABLE: ASI-221-1 TO 25 PIN TEST CONNECTOR	ASI DEALER
ASI-22-11D			CABLE: ASI-221-1 TO 51R-7A/8A/8B	ASI DEALER
ASI-22-12A			CABLE: ASI-221-2 TO 618M-1/2B/2D/3/3A/4/4A/5/5A	ASI DEALER
ASI-22-12B			CABLE: ASI-221-2 TO UUT 29 PIN TEST CONNECTOR	ASI DEALER
ASI-22-12C			CABLE: ASI-221-2 TO G7406	ASI DEALER
ASI-23-6A			CABLE: ASI-236 TO 51Z-3/-4	ASI DEALER
ASI-23-6B			CABLE: ASI-236 TO 51Z-6	ASI DEALER
ASI-24-2A			CABLE: ASI-242R TO 621A-6/6A	ASI DEALER
ASI-24-2B			CABLE: ASI-242R TO 621A-3	ASI DEALER
ASI-24-2C			IF AMPLIFIER ALIGNMENT COVER FOR 621A-6 (MAN FIG 1002)	ASI DEALER
ASI-24-4A		2039608-0501	CABLE: ASI-244-1 (PPT-1FB) W101	ASI DEALER
ASI-24-8A			CABLE: ASI-248 TO AIU-4000	ASI DEALER
ASI-24-9A		676-1949-011	CABLE: ASI-249 TO SVT-1000	ASI DEALER
ASI-24-42A		2039608-0502	CABLE: ASI-244-2 (PPT-1FB) W101	ASI DEALER
ASI-24-42B		8056285-0501	CABLE: ASI-244-2 (PPT-1FB) W102	ASI DEALER
ASI-25-2A		2041579-0502	CABLE: ASI-252-1 (COT-1FB) W101	ASI DEALER
ASI-25-2B		2041580-0501	CABLE: ASI-252-1 (COT-1FB) W102	ASI DEALER
ASI-25-22A		2040035-0501	CABLE: ASI-252-2 (COT-4A) W1	ASI DEALER
ASI-25-22B		2040020-0501	CABLE: ASI-252-2 (COT-4A) W2	ASI DEALER
ASI-25-22C			CABLE: ASI-252-2 (COT-4A) TO IFR STD-7000 (REQ FOR CALIBRATION ONLY)	ASI DEALER
ASI-25-3A			CABLE: ASI-253 TO VG-204()	ASI DEALER
ASI-25-3B			CABLE: ASI-253 TO VG-206()	ASI DEALER
ASI-25-3C			CABLE: ASI-253 TO VG-208	ASI DEALER
ASI-25-7A			CABLE: ASI-257 (CTS-451) TO DME-451 (W1)	ASI DEALER
ASI-25-8A			CABLE: MAIN EXT FOR 339H-6 (MAN FIG 908)	ASI DEALER
ASI-25-8B			CABLE: PWR SUPPLY EXT FOR 339H-6 (MAN FIG 909)	ASI DEALER
ASI-25-9A		647-6485-003	SERVO ASSY PIN NO. 3 (339H-6 MAN FIG 920)	ASI DEALER
ASI-25-9B		647-6485-004	SERVO ASSY PIN NO. 4 (339H-6 MAN FIG 920)	ASI DEALER
ASI-25-9C		647-6485-001	SERVO ASSY PIN NO 1 (RDMI-743)	ASI DEALER
ASI-25-9D		647-6485-002	SERVO ASSY PIN NO 2 (RDMI-743)	ASI DEALER
ASI-25-9E		647-6485-005	SERVO ASSY PIN NO 5	ASI DEALER
ASI-26-01A		T321703-49	CABLE: ASI-260-1 PWR (W1)	ASI DEALER
ASI-26-01B		T321703-50	CABLE: ASI-260-1 (T321703) TO UUT (W2)	ASI DEALER
ASI-26-01C		T321703-51	CABLE: ASI-260-1 (T321703) TO UUT (W3)	ASI DEALER
ASI-26-01D		T321677	INDEXING TURNTABLE	ASI DEALER
ASI-26-01E		T321686	VG-401 HOLDING FIXTURE	ASI DEALER
ASI-26-01F		T3012055	HOLDING FIXTURE	ASI DEALER
ASI-26-01G		T3012067	SLIPRING GUARD	ASI DEALER
ASI-26-01H		T893165	BRUSH GUARD	ASI DEALER
ASI-26-01J		T3012074	HEMISPHERE ALIGNING FIXTURE	ASI DEALER

AVAILABILITY:

ASI DEALER: CONTACT ANY ASI DEALER FOR QUOTE
 COLLINS: CONTACT ROCKWELL COLLINS FOR QUOTE
 GABLES: CONTACT GABLES ENGINEERING FOR QUOTE
 TELEPHONICS: CONTACT TELEPHONICS FOR QUOTE

ASI SPECIALIZED TEST EQUIPMENT LIST

AVAILABILITY SUBJECT TO CHANGE WITHOUT NOTICE

ASI MN	EQUIV MN	EQUIV PN	DESCRIPTION	AVAILABILITY
ASI-26-01K		T3012040	SYNCHRO ALIGNMENT BLOCK	ASI DEALER
ASI-26-01L		T3012026	SYNCHRO CEMENTING FIXTURE	ASI DEALER
ASI-26-01M		T3012027	SLIPRING ALIGNMENT FIXTURE	ASI DEALER
ASI-26-01N		T3012029	SLIPRING ALIGNMENT TOOL	ASI DEALER
ASI-26-01P		T3012050	ROTOR SHIMMING FIXTURE	ASI DEALER
ASI-26-01Q		T3013063	BRAKE SHIMMING FIXTURE	ASI DEALER
ASI-26-01R		T3012066	ROTOR ASSEMBLY BUSHING (SAME AS ASI-27-5D)	ASI DEALER
ASI-26-01S		T3012062	ANVIL	ASI DEALER
ASI-26-01T		T3012469	ADAPTER SET	ASI DEALER
ASI-26-01U		T675344	TORQUE NUT DRIVER	ASI DEALER
ASI-26-01V		T3009296	OFFSET WRENCH	ASI DEALER
ASI-26-01W		T3012054	ROTOR BALANCE ADAPTER SET	ASI DEALER
ASI-26-01X		T674655	STATIC BALANCE FIXTURE	ASI DEALER
ASI-26-01Y		T3017560	BALANCE WEIGHT	ASI DEALER
ASI-26-01Z		T3012042	ALIGNMENT PLATE	ASI DEALER
ASI-26-02A		T321705-49	CABLE: ASI-260-2 PWR (W1)	ASI DEALER
ASI-26-02B		T321705-50	CABLE: ASI-260-2 (T321705) TO UUT (W2)	ASI DEALER
ASI-26-02C		T321705-51	CABLE: ASI-260-2 (T321705) TO UUT (W3)	ASI DEALER
ASI-26-02D		T897177	RUN-OUT FIXTURE	ASI DEALER
ASI-26-02E		T3012051	GIMBAL SHIMMING STEP PLUG	ASI DEALER
ASI-26-02F		T3000626	HOLDING BLOCK	ASI DEALER
ASI-26-02G		T898656	DIAL INDICATOR POST	ASI DEALER
ASI-26-02H		T626912	GIMBAL BALANCING FIXTURE	ASI DEALER
ASI-26-02J		T3013271	SPACER BLOCK	ASI DEALER
ASI-26-02K		T322896	BASE HOLDING FIXTURE	ASI DEALER
ASI-26-02L		T322710	NUT COVER TIGHTENING TOOL	ASI DEALER
ASI-26-3E			CABLE: ASI-263 TO TEST DISPLAY UNIT	ASI DEALER
ASI-26-3F			CABLE: TEST CARD EXTENDER A FOR WC-850/870	ASI DEALER
ASI-26-3G			CABLE: TEST CARD EXTENDER B FOR WC-850/870	ASI DEALER
ASI-26-3H			TEST FIXTURE: COVER ON TEMPLATE	ASI DEALER
ASI-26-3J			CABLE: HIGH VOLTAGE JUMPER	ASI DEALER
ASI-26-3K1			CABLE: AZIMUTH MOTOR HARNESS JUMPER	ASI DEALER
ASI-26-3K2			CABLE: ELEVATION MOTOR HARNESS JUMPER	ASI DEALER
ASI-26-32D		T336275	CABLE: WU EXTENDER, 68 POSITION	ASI DEALER
ASI-26-6E			CABLE: ASI-266 TO WC-810	ASI DEALER
ASI-26-6F			CABLE: ASI-266 TO TEST DISPLAY UNIT (T334579)	ASI DEALER
ASI-26-6J			ELEVATION DRIVE CABLE ADJUSTMENT TOOL	ASI DEALER
ASI-26-6J1			CABLE: P800 TEST HARNESS TO WC-8XX CTL AND WI-800 SLAVE IND	ASI DEALER
ASI-26-9J			CABLE: RECEIVER EXTENDER 653-2349-001 (12 PIN / DOUBLE ROW / PIN 8 KEY)	ASI DEALER
ASI-26-9J1			CABLE: RECEIVER EXTENDER 659-7802-001 (8 PIN / DOUBLE ROW / PIN 7 KEY)	ASI DEALER
ASI-26-9K			CABLE: A7P1 EXT 676-5300/827-3493/628-6960 (28 PIN / DOUBLE ROW / PIN 10 KEY)	ASI DEALER
ASI-26-9K1			CABLE: P1 EXT 628-9858-002/-002 (28 PIN / DOUBLE ROW / PIN 17 KEY)	ASI DEALER
ASI-26-9K2			CABLE: A4A5P1 EXT 653-3853-001 (28 PIN / DOUBLE ROW / PIN 6 KEY)	ASI DEALER
ASI-26-9L			CABLE: SCAN TO SCAN BYPASS (16 PIN / DOUBLE ROW)	ASI DEALER
ASI-26-9M			CABLE: TILT ERROR ADAPTER (10 PIN / DOUBLE ROW / PIN 10 KEY)	ASI DEALER
ASI-26-9N			CABLE: EXCITER EXT 622-9744-002 (6 PIN / SINGLE ROW / NO KEY)	ASI DEALER
ASI-26-9N1			CABLE: EXCITER EXT (6 PIN / SINGLE ROW / PIN 3 KEY)	ASI DEALER
ASI-27-0A		1711819-504	CABLE: ASI-270(J3) TO AFC(P501)	ASI DEALER
ASI-27-0B		1711819-502	CABLE: ASI-270(J1) TO IF(P404)	ASI DEALER
ASI-27-0C		1711819-503	CABLE: ASI-270(J2) TO GENERATOR	ASI DEALER
ASI-27-0D		1717866-501	DUMMY MIXER: IF AMP ALIGN AND BANDWIDTH	ASI DEALER
ASI-27-0E		1717868-501	DUMMY MIXER: IF AMP AND ISOCONTOUR	ASI DEALER
ASI-27-0F		1717869-503	DUMMY MIXER: AFC BANDPASS FILT / DESC	ASI DEALER
ASI-27-5A1		T322745-1	CABLE: ASI-275-1 (T307976) TO C-14 GYRO SYNCHRONIZER (PN 4019190-1 THRU -7)	ASI DEALER
ASI-27-5A2		T322745-2	CABLE: ASI-275-1 (T307976) TO C-14 GYRO SYNCHRONIZER (PN 4019190-13/-16/-18)	ASI DEALER
ASI-27-5A3		T322771	CABLE: ASI-275-1 (T307976) TO C-14 GYRO SYNCHRONIZER (PN 4019190-13/-16)	ASI DEALER
ASI-27-5A4		T322870	CABLE: ASI-275-1 (T307976) TO C-14D GYRO (PN 4020577-VAR)	ASI DEALER
ASI-27-5B		T307972	SCORSBY ADAPTER PLATE	ASI DEALER
ASI-27-5C1		T3012061-A	ROTOR CLAMP A	ASI DEALER
ASI-27-5C2		T3012061-B	ROTOR CLAMP B	ASI DEALER
ASI-27-5D		T3012066	ROTOR ASSEMBLY BUSHING (SAME AS ASI-26-01R)	ASI DEALER
ASI-27-5E		T897487	HEIGHT DIMENSION GAUGE	ASI DEALER
ASI-27-5F		T3075022	BEARING PARALLEL CHECKING TOOL	ASI DEALER
ASI-27-5G		T898487	OPEN END WRENCH	ASI DEALER
ASI-27-5H		T896500	BEARING PRELOAD ADAPTER SET	ASI DEALER
ASI-27-5I		T891970	BEARING PRELOAD FIXTURE	ASI DEALER
ASI-27-5J		T896497	ROTOR BALANCING ADAPTERS	ASI DEALER
ASI-27-5K		T896276	ROTOR BALANCING CRADLE	ASI DEALER
ASI-27-5L		T897024	TERMINAL INSERTER	ASI DEALER

AVAILABILITY:

ASI DEALER: CONTACT ANY ASI DEALER FOR QUOTE
 COLLINS: CONTACT ROCKWELL COLLINS FOR QUOTE
 GABLES: CONTACT GABLES ENGINEERING FOR QUOTE
 TELEPHONICS: CONTACT TELEPHONICS FOR QUOTE

ASI SPECIALIZED TEST EQUIPMENT LIST

AVAILABILITY SUBJECT TO CHANGE WITHOUT NOTICE

<u>ASI MN</u>	<u>EQUIV MN</u>	<u>EQUIV PN</u>	<u>DESCRIPTION</u>	<u>AVAILABILITY</u>
ASI-27-5M		T897413	SLIPRING CEMENTING CLAMPS	ASI DEALER
ASI-27-5N		T896625	SWITCH RING ALIGNMENT FIXTURE	ASI DEALER
ASI-27-5P		T896455	MAGNET CEMENTING FIXTURE	ASI DEALER
ASI-27-5Q		T897167	STATIC BALANCE FIXTURE	ASI DEALER
ASI-27-5R		T896773	SLIPRING ALIGNING AND CEMENTING TOOL	ASI DEALER
ASI-27-5S		T896871	SLIPRING PROTECTOR	ASI DEALER
ASI-27-5T		T898023	DIAL INDICATOR MOUNTING ADAPTER	ASI DEALER
ASI-27-5U		T896598	GIMBAL ASSEMBLY BALANCE FIXTURE	ASI DEALER
ASI-27-5V		T3008089	DIAL INDICATING MOUNTING ADAPTER	ASI DEALER
ASI-27-5W		T896496	STATOR LOC. AND CEMENTING FIXTURE	ASI DEALER
ASI-27-5X		T3009480	TEST WEIGHT	ASI DEALER
ASI-27-5Y		T896405	PUNCH AND ANVIL	ASI DEALER
ASI-27-5Z		T896499	PRESSING TOOL	ASI DEALER
ASI-28-2A			BOX 1 BREAKOUT BOX FOR 980L-1/1A	ASI DEALER
ASI-28-2B			PWR INTLK SHORTING CONN	ASI DEALER
ASI-28-2C			BOX 2 CONTINUITY TESTER	ASI DEALER
ASI-28-5A			CABLE: ASI-285 TO COLLINS 329B-4()	ASI DEALER
ASI-28-5B			CABLE: ASI-285 TO COLLINS 329B-6() (329B-6D/E MAN FIG 1004)	ASI DEALER
ASI-28-6A		634-9647-001	CABLE: FGC-80 UNIT	ASI DEALER
ASI-28-6B		634-9648-001	CABLE: FGC-80 AIRCRAFT	ASI DEALER
ASI-28-6C		634-9649-001	CABLE: APC-80 UNIT	ASI DEALER
ASI-28-6D		634-9650-001	CABLE: APC-80 AIRCRAFT	ASI DEALER
ASI-28-6E		634-9651-001	CABLE: APA-80 UNIT	ASI DEALER
ASI-28-6F		634-9652-001	CABLE: APA-80 AIRCRAFT	ASI DEALER
ASI-28-6G		634-9653-001	CABLE: 562A-5M5 UNIT	ASI DEALER
ASI-28-6H		634-9654-001	CABLE: 562A-5M5 AIRCRAFT	ASI DEALER
ASI-28-6I		634-9655-001	CABLE: 562C-5 UNIT	ASI DEALER
ASI-28-6J		634-9656-001	CABLE: 562C-5 AIRCRAFT	ASI DEALER
ASI-28-7A	CT3124		CABLE: ASI-287 (CT2542) TO 627248	ASI DEALER
ASI-28-7B	CT8008		EXTENDER CARD: 36 POS	ASI DEALER
ASI-28-7C	CR8007		SHAFT EXTENDER: S1	ASI DEALER
ASI-28-8A		629-9929-001	CABLE: ASI-288 (968A-1) TO FMC-28/28A J1 (W1)	ASI DEALER
ASI-28-8B		629-9929-002	CABLE: ASI-288 (968A-1) TO FMC-28/28A J2 (W2)	ASI DEALER
ASI-28-8C		629-9935-001	EXTENDER CARD: FMC-28/28A (P6-J6) (W3)	ASI DEALER
ASI-28-8D		629-9935-002	EXTENDER CARD: FMC-28/28A (P7-J7) (W4)	ASI DEALER
ASI-28-8E			CABLE: ASI-288 TO ASI-167 (978F-2S)	ASI DEALER
ASI-29-1A		634-9424-001	CABLE: ASI-291 (968J-1) TO COLLINS 622-4149-001 (W1)	ASI DEALER
ASI-29-1B		634-9425-001	CABLE: ASI-291 (968J-1) TO COLLINS 622-4149-001 (W2)	ASI DEALER
ASI-29-2A			CABLE: ASI-292 TO ATC-1400	ASI DEALER
ASI-29-4A		638-2433-001	CABLE: ASI-294 (970D-2) TO ADC-80() (W1)	ASI DEALER
ASI-29-6A		629-4898-001	CABLE: ASI-296 (971T-1) TO FPC-75(BP/TP) (W1)	ASI DEALER
ASI-29-6B		629-4899-001	CABLE: ASI-296 (971T-1) TO FPC-75(ATE) (W2)	ASI DEALER
ASI-29-6C		629-4886-001	CABLE: ASI-296 (971T-1) 115 VAC 400 HZ PWR (W3)	ASI DEALER
ASI-29-6D		547-2795-000	CABLE: ASI-296 (971T-1) 115 VAC 60 HZ PWR (W4)	ASI DEALER
ASI-29-6E		629-4851-001	CABLE: ASI-296 (971T-1) RED PROBE	ASI DEALER
ASI-29-6F		629-4851-002	CABLE: ASI-296 (971T-1) BLK PROBE	ASI DEALER
ASI-29-6G		629-4851-003	CABLE: ASI-296 (971T-1) GRN PROBE	ASI DEALER
ASI-29-9A			CABLE: ASI-299 TO ALT-4000 / ALT-50A / ALT-55B	ASI DEALER
ASI-29-9B			CABLE: ASI-299 TO ALI-55	ASI DEALER
ASI-29-9C			CABLE: ASI-299 TO DRI-55 (FOR USE WITH BOTH ALT-55 AND ALT-4000)	ASI DEALER
ASI-29-9C1			CABLE: ASI-299 TO DRI-55 (FOR USE WITH ALT-55 ONLY)	ASI DEALER
ASI-29-9C2			CABLE: ASI-299 TO DRI-55 (FOR USE WITH ALT-4000 ONLY)	ASI DEALER
ASI-29-9D			TEST FIXTURE: ALT-50/55 PRE AMPLIFIER	ASI DEALER
ASI-29-9E			ALT-4000 DIG CARD EXT CABLE	ASI DEALER
ASI-29-9F			ALT-4000 DIG TO XMTR CARD EXT	ASI DEALER
ASI-29-9G			ALT-4000 BITE CABLE FOR CTC-429	ASI DEALER
ASI-29-9H			ALT-4000 DIG TO TRANSMITTER CARD EXTENDER	ASI DEALER
ASI-29-9J			ALT-4000 BITE INTERFACE CABLE FOR GP-429	ASI DEALER
ASI-29-9K			ALT-50A/55B/860F-2 SPECIAL RF TEST CABLE (2 EACH REQUIRED FOR TESTING)	ASI DEALER
ASI-29-9K1			CABLE: SPECIAL RF, 9.3 FT RG-214/U / N MALE TO N MALE	ASI DEALER
ASI-29-42A		827-6554-001	CABLE: ASI-294-2 (970D-2A) TO ADC-80() (W1)	ASI DEALER
ASI-29-42B		827-6554-002	CABLE: ASI-294-2 (970D-2A) TO ADC-85/86/850 (W2)	ASI DEALER
ASI-30-1A		751-1767-001	CABLE: ASI-301 (973W-3) W1	ASI DEALER
ASI-30-1B		751-1767-002	CABLE: ASI-301 (973W-3) W2	ASI DEALER
ASI-30-1C		751-1767-003	CABLE: ASI-301 (973W-3) W3	ASI DEALER
ASI-30-1D		751-1766-001	CABLE: ASI-301 (973W-3) W4	ASI DEALER
ASI-30-1E		751-1766-002	CABLE: ASI-301 (973W-3) W5	ASI DEALER
ASI-30-1F		751-1765-001	CABLE: ASI-301 (973W-3) W6	ASI DEALER
ASI-30-1G		751-1762-001	CABLE: ASI-301 (973W-3) W7	ASI DEALER

AVAILABILITY:

ASI DEALER: CONTACT ANY ASI DEALER FOR QUOTE
 COLLINS: CONTACT ROCKWELL COLLINS FOR QUOTE
 GABLES: CONTACT GABLES ENGINEERING FOR QUOTE
 TELEPHONICS: CONTACT TELEPHONICS FOR QUOTE

ASI SPECIALIZED TEST EQUIPMENT LIST

AVAILABILITY SUBJECT TO CHANGE WITHOUT NOTICE

ASI MN	EQUIV MN	EQUIV PN	DESCRIPTION	AVAILABILITY
ASI-30-1H		751-8272-001	CABLE: ASI-301 (973W-3) W8	ASI DEALER
ASI-30-1K			MICROPHONE SIMULATOR FOR ASI-300 / ASI-301	ASI DEALER
ASI-30-2A		651-3032-001	CABLE: ASI-302 (966B-1) TO POWER AMP	ASI DEALER
ASI-30-2B		651-3028-001	CABLE: ASI-302 (966B-1) TO POWER SUPPLY	ASI DEALER
ASI-30-2C		651-3663-001	CABLE: ASI-302 (966B-1) RF	ASI DEALER
ASI-30-2D		651-3667-001	CABLE: ASI-302 (966B-1) RF	ASI DEALER
ASI-30-2E		651-3667-002	CABLE: ASI-302 (966B-1) RF	ASI DEALER
ASI-30-2F		651-3669-001	CABLE: ASI-302 (966B-1) RF	ASI DEALER
ASI-30-8A		629-0389-001	CABLE: ASI-308-1/-2 (AN/ARM-165/-165A) W1	ASI DEALER
ASI-30-8B		629-0390-001	CABLE: ASI-308-1/-2 (AN/ARM-165/-165A) W2	ASI DEALER
ASI-30-8C		629-0391-001	CABLE: ASI-308-1/-2 (AN/ARM-165/-165A) W3	ASI DEALER
ASI-30-8D		629-0392-001	CABLE: ASI-308-1/-2 (AN/ARM-165/-165A) W4	ASI DEALER
ASI-30-8E		629-9063-001	CABLE: ASI-308-1/-2 (AN/ARM-165/-165A) W5	ASI DEALER
ASI-30-8F		629-9064-001	CABLE: ASI-308-1/-2 (AN/ARM-165/-165A) W6	ASI DEALER
ASI-30-8G		629-9065-001	CABLE: ASI-308-1/-2 (AN/ARM-165/-165A) W7	ASI DEALER
ASI-30-8H		629-9067-001	CABLE: ASI-308-1/-2 (AN/ARM-165/-165A) W8	ASI DEALER
ASI-30-8J		629-9068-001	CABLE: ASI-308-1/-2 (AN/ARM-165/-165A) W9	ASI DEALER
ASI-30-8K		629-9515-001	CABLE: ASI-308-1/-2 (AN/ARM-165/-165A) W11	ASI DEALER
ASI-30-9A		659-3488-002	CABLE: ASI-309 1553 ADDRESS CABLE	ASI DEALER
ASI-31-0A		629-9161-001	CABLE: ASI-310 (438K-2) W1	ASI DEALER
ASI-31-0B		629-9162-001	CABLE: ASI-310 (438K-2) W2	ASI DEALER
ASI-31-0C		629-9163-001	CABLE: ASI-310 (438K-2) W3	ASI DEALER
ASI-31-0D		629-9164-001	CABLE: ASI-310 (438K-2) W4	ASI DEALER
ASI-31-0E		629-9165-001	CABLE: ASI-310 (438K-2) W5	ASI DEALER
ASI-31-0F		629-9167-001	CABLE: ASI-310 (438K-2) W7	ASI DEALER
ASI-31-0G		646-6578-001	CABLE: ASI-310 (438K-2) W8	ASI DEALER
ASI-31-0H		646-7044-001	EXTENDER CARD: ASI-310 (438K-2)	ASI DEALER
ASI-31-3A		629-0102-001	CABLE: ASI-313 (MX-9626/ARM) RF CABLE	ASI DEALER
ASI-32-4A		752-7275-001	CABLE: ASI-324 (964R-2) W1	ASI DEALER
ASI-32-71A			TEST ADAPT: ASI-327-1 TO 51RV-4/5 / 51R-10 (51RV-4/5 MAN FIG 907)	ASI DEALER
ASI-32-71B			BREAKOUT BOX: 51RV-4/5 / 51R-10 (51RV-4/5 MAN FIG 907)	ASI DEALER
ASI-32-72A			TEST ADAPT: ASI-327-2 TO 618M-() WITHOUT ATE CONNECTOR	ASI DEALER
ASI-32-81A		761-4400-001	CABLE: ASI-328-1 (878L-15) W2	ASI DEALER
ASI-32-82A		554-6957-001	CABLE: ASI-328-2 (878L-16) W3	ASI DEALER
ASI-32-83A		554-6958-001	CABLE: ASI-328-3 (878L-17) W4	ASI DEALER
ASI-32-83B		637-1964-001	DISCRIMINATOR TESTER ADAPTER FOR 548S-()	ASI DEALER
ASI-32-84A		761-4600-001	CABLE: ASI-328-4 (980H-1 POWER PANEL) W1	ASI DEALER
ASI-32-93A			GROUND PLANE PLATE FOR 490S-1 / CPL-920D (MOUNTS ON ASI-329-3)	ASI DEALER
ASI-32-93B			GROUND PLANE PLATE FOR 490S-4/4A/4B / CU-2314(V)4 (MOUNTS ON ASI-329-3)	ASI DEALER
ASI-32-93C			GROUND PLANE PLATE FOR 490S-4/4A/4B (MOUNTS ON ASI-329-3 AND ASI-329-301)	ASI DEALER
ASI-32-93D			GROUND PLANE PLATE FOR HF-9041 (MOUNTS ON ASI-329-3)	ASI DEALER
ASI-32-94A			COAXIAL ADAPTER FOR CU-2275(V)/ARC-190(V)	ASI DEALER
ASI-32-94B			ADAPTER BRACKET FOR CU-2575/ARC-229	ASI DEALER
ASI-32-94C			ADAPTER CABLE FOR CU-2575/ARC-229	ASI DEALER
ASI-32-94D			COUPLER ADAPTER CABLE FOR CU-2575/ARC-229	ASI DEALER
ASI-32-98A			CABLE, ASI-329-8 TO HF-9042	ASI DEALER
ASI-32-98B			CABLE, HF-9042 N CONNECTOR	ASI DEALER
ASI-33-9A		775-9706-001	CABLE: 3W1	ASI DEALER
ASI-33-81A		638-2405-001	TEST FIXTURE: ALC MONITOR	ASI DEALER
ASI-33-81B		638-2406-001	TEST FIXTURE: SNIFFER	ASI DEALER
ASI-33-81C		638-2362-001	CABLE: RF/TCR	ASI DEALER
ASI-33-81D		638-2388-001	CABLE: RF/PWR	ASI DEALER
ASI-33-81E		634-9480-001	CABLE: CTL-201/201A/220	ASI DEALER
ASI-33-81F		TP6-3955-013-1	CABLE: CTL-230	ASI DEALER
ASI-33-83A		638-2383-001	CABLE: TCR	ASI DEALER
ASI-33-83B		638-2384-001	CABLE: PWR	ASI DEALER
ASI-33-83C		638-2385-001	CABLE: AAC (37 PIN D CONNECTOR)	ASI DEALER
ASI-33-83D		638-2404-001	TEST FIXTURE: ALC CAPACITOR	ASI DEALER
ASI-33-83E		634-9021-001	TEST FIXTURE	ASI DEALER
ASI-33-83F		634-9022-001	TEST FIXTURE: DISCRIMINATOR ALIGNMENT BOX	ASI DEALER
ASI-33-83G		628-8442-001	CABLE: AAC-200P/220P (CIRCULAR CONNECTOR PER CTS-202 SIL1-86)	ASI DEALER
ASI-33-83H		628-8518-001	CABLE: PAC-200/230 TO CTS-200/202 ADAPTER CABLE	ASI DEALER
ASI-33-83J		628-8519-001	PAC-200/230 ANTENNA SIMULATOR (DUMMY LOAD)	ASI DEALER
ASI-33-83K		622-8522-001	PAC-200/230 TEST CRADLE	ASI DEALER
ASI-33-83L		TP6-1146-011	ATM-200 BREAKOUT CABLE	ASI DEALER
ASI-33-84A		638-2448-001	CABLE: AAC/PAC	ASI DEALER
ASI-33-84B		628-8526-001(1)	PAC-200/230 IN CIRCUIT TEST CABLE	ASI DEALER
ASI-33-84C		628-8526-001(2)	PAC-200/230 OUT OF CIRCUIT TEST CABLE	ASI DEALER
ASI-33-85A		634-9995-001	CABLE: W1	ASI DEALER

AVAILABILITY:

ASI DEALER: CONTACT ANY ASI DEALER FOR QUOTE
 COLLINS: CONTACT ROCKWELL COLLINS FOR QUOTE
 GABLES: CONTACT GABLES ENGINEERING FOR QUOTE
 TELEPHONICS: CONTACT TELEPHONICS FOR QUOTE

ASI SPECIALIZED TEST EQUIPMENT LIST

AVAILABILITY SUBJECT TO CHANGE WITHOUT NOTICE

ASI MN	EQUIV MN	EQUIV PN	DESCRIPTION	AVAILABILITY
ASI-33-85B		634-9996-001	CABLE: W2	ASI DEALER
ASI-33-85C		634-9994-001	CABLE: W3	ASI DEALER
ASI-33-85D		TP6-2800-013	CABLE: SELCAL WIRING CHECK ADAPTER	ASI DEALER
ASI-33-91A			CABLE: RF	ASI DEALER
ASI-33-91B		772-6874-001	HOUSING	ASI DEALER
ASI-33-91C		772-6875-001	HOUSING	ASI DEALER
ASI-33-92A		791-3393-001	CABLE: 3W2	ASI DEALER
ASI-33-92B		791-3381-001	CARD EXTENDER	ASI DEALER
ASI-33-93A		792-0055-001	CARD HOLDER	ASI DEALER
ASI-33-93B		792-0042-001	CABLE: ADAPTER	ASI DEALER
ASI-33-93C		787-8303-001	CARD EXTENDER	ASI DEALER
ASI-33-93D		792-0031-001	CABLE: 2W1	ASI DEALER
ASI-33-93E		792-0032-001	CABLE: 2W2	ASI DEALER
ASI-33-94A		791-3366-001	CARD HOLDER	ASI DEALER
ASI-33-94B		787-8891-001	CABLE: 1W2	ASI DEALER
ASI-33-95A		792-0202-001	CABLE: POWER	ASI DEALER
ASI-34-01A		757-6385-001	CABLE: W1	ASI DEALER
ASI-34-01B			437R-1 CONTACT ADJUSTMENT TOOL (437R-1 / 980H-2 MAN FIG 5-10)	ASI DEALER
ASI-34-4A		634-3060-001	CABLE: ASI-344 TO DAU-850/CTS-2000	COLLINS
ASI-34-5A		621-3517-001	CABLE: ASI-345 (578F-1) TO 334C-3	ASI DEALER
ASI-34-5B			SPANNER WRENCH FOR 334C-3	ASI DEALER
ASI-34-8A			CABLE: ASI-348 TO SVO-65	ASI DEALER
ASI-34-8B		135-3602-961	BALL BEARING INNER RACE REMOVAL TOOL	ASI DEALER
ASI-34-8C		135-3602-122	BALL BEARING ASSEMBLY FIXTURE	ASI DEALER
ASI-34-62A		554-4825-000	CABLE: TEST	ASI DEALER
ASI-34-63A		772-6877-001	CABLE: RF	ASI DEALER
ASI-34-64A		772-6878-001	CABLE: POWER	ASI DEALER
ASI-34-82C		827-1543-001	CLUTCH TEST FIXTURE	ASI DEALER
ASI-34-82D		634-1942-001	TSM-1001 CAPSTAN LOCKING FIXTURE	ASI DEALER
ASI-34-82E		634-1943-001	SMT-1001 CAPSTAN LOCKING FIXTURE	ASI DEALER
ASI-34-82F		634-1785-001	TSM-1000 CAPSTAN LOCKING FIXTURE	ASI DEALER
ASI-34-96A		06-44201	CABLE: ASI-349-6 TO 90-44201-2 (P/O ASI-349-6)	ASI DEALER
ASI-35-4A		638-0246-001	CABLE: ASI-354 TO AHC-85	ASI DEALER
ASI-35-4B		638-0246-002	CABLE: ASI-354 TO AHC-85	ASI DEALER
ASI-35-4C		638-0246-003	CABLE: ASI-354 TO AHC-85-A5	ASI DEALER
ASI-35-4D		638-0246-004	CABLE: ASI-354 TO AHC-85-A6	ASI DEALER
ASI-35-4E		638-0246-005	CABLE: ASI-354 TO COMPUTER	ASI DEALER
ASI-35-4F		638-0246-006	CABLE: ASI-354 TO COMPUTER	ASI DEALER
ASI-35-4G		638-0246-007	CABLE: ASI-354 TO AHC-85	ASI DEALER
ASI-35-41A			CABLE: 440Y-76 TO PRO LINE II CARD (APC-65/FGC-65)	ASI DEALER
ASI-35-41B			CABLE: REAR 36 PIN EXTENDER FOR APC-65/FGC-65	ASI DEALER
ASI-35-41C			CABLE: REAR 30 PIN EXTENDER FOR APC-65/FGC-65	ASI DEALER
ASI-35-41D			CABLE: REAR 26 PIN EXTENDER FOR APC-65/FGC-65	ASI DEALER
ASI-35-41E			CABLE: FRONT EXTENDER FOR APC-65/FGC-65	ASI DEALER
ASI-35-5A		638-0716-001	CABLE: ASI-355 TO VHF-21	ASI DEALER
ASI-35-5B		638-0717-001	CABLE: ASI-355 TO VHF-22	ASI DEALER
ASI-35-5C		638-0721-001	CABLE: ASI-355 TO VHF-422	ASI DEALER
ASI-35-5D		638-0723-001	CABLE: ASI-355 TO VHF-ESS INTERFACE	ASI DEALER
ASI-35-7A			CABLE: ASI-357 TO KDM-706 / KTU-709	ASI DEALER
ASI-35-7B			CABLE: ASI-357 TO KN-62 / -62A / -64	ASI DEALER
ASI-35-7C			CABLE: ASI-357 TO KN-63	ASI DEALER
ASI-35-7D			CABLE: ASI-357 TO KDI-572 / -574	ASI DEALER
ASI-35-7E			CABLE: ASI-357 TO KDI-573	ASI DEALER
ASI-35-7F			CABLE: ASI-357 TO KFS-562	ASI DEALER
ASI-35-7G			CABLE: ASI-357 TO KX-170A / -170B / -175A / -175B	ASI DEALER
ASI-35-7H			CABLE: ASI-357 TO KDA-689 (USER MUST WIRE INDICATOR CONNECTOR TO CABLE)	ASI-DEALER
ASI-35-8A		634-9812-001	CABLE: ASI-358 (969Y-1) TO 331D-7 HSI (P/O ASI-358 HSI TEST PANEL) (W1)	ASI DEALER
ASI-35-8B		601-2274-001	EXTENDER CARD A6: 331D-7 HSI	ASI DEALER
ASI-35-8C		601-2275-001	EXTENDER CARD A4: 331D-7 HSI	ASI DEALER
ASI-35-8D		601-2276-001	EXTENDER CARD A3: 331D-7 HSI	ASI DEALER
ASI-35-8E		601-2277-001	EXTENDER CARD A5: 331D-7 HSI	ASI DEALER
ASI-36-0E			CABLE: ASI-360 TO ART-161A	ASI DEALER
ASI-36-0F			CABLE: ASI-360 TO RDS-81/82 SYSTEM	ASI DEALER
ASI-36-1A			CABLE: ASI-361 TO KVG-350 (P/O ASI-361)	ASI DEALER
ASI-36-1B			CABLE: ASI-361 TO KVG-350 (RUN-IN CABLE)	ASI DEALER
ASI-36-1C		696-4826-00	BEARING INSTALLATION TOOL FOR KVG-350	ASI DEALER
ASI-36-1D		696-4827-00	INERTIA WHEEL BEARING PULLER FOR KVG-350	ASI DEALER
ASI-36-1E		696-4828-00	GYRO MOUNTING PLATE FOR KVG-350	ASI DEALER
ASI-36-1F		696-4829-00	INNER GIMBAL CAP DEFLECTOR FIXTURE FOR KVG-350	ASI DEALER

AVAILABILITY:

ASI DEALER: CONTACT ANY ASI DEALER FOR QUOTE
 COLLINS: CONTACT ROCKWELL COLLINS FOR QUOTE
 GABLES: CONTACT GABLES ENGINEERING FOR QUOTE
 TELEPHONICS: CONTACT TELEPHONICS FOR QUOTE

ASI SPECIALIZED TEST EQUIPMENT LIST

AVAILABILITY SUBJECT TO CHANGE WITHOUT NOTICE

<u>ASI MN</u>	<u>EQUIV MN</u>	<u>EQUIV PN</u>	<u>DESCRIPTION</u>	<u>AVAILABILITY</u>
ASI-36-1G		696-4830-00	INERTIA WHEEL CAP/ROTOR INSTALLATION TOOL FOR KVG-350	ASI DEALER
ASI-36-1H		696-4831-00	TORQUER STATOR PULLER FOR KVG-350	ASI DEALER
ASI-36-1J		696-4832-00	INERTIA WHEEL CAP/ROTOR PULLER FOR KVG-350	ASI DEALER
ASI-36-1K		696-4833-00	TORQUER STATOR INSTALLATION TOOL FOR KVG-350	ASI DEALER
ASI-36-1L		696-4834-00	SYNCHRO VERTICALITY ADJUSTMENT TOOL FOR KVG-350	ASI DEALER
ASI-36-1M		696-4835-00	END PLAY FIXTURE FOR KVG-350	ASI DEALER
ASI-36-1N		696-4836-00	SOLDER SHIELDS FOR KVG-350	ASI DEALER
ASI-36-1P		696-4839-00	GIMBAL PLATE FOR KVG-350	ASI DEALER
ASI-36-1Q		696-4840-00	FRAME STAND FOR KVG-350	ASI DEALER
ASI-36-1R		696-4841-00	GIMBAL STABILIZATION FIXTURE FOR KVG-350	ASI DEALER
ASI-36-1S		696-4842-00	10 DEGREE ANGLE PLATE FOR KVG-350	ASI DEALER
ASI-36-1T		696-4844-00	BRUSH BLOCK INSTALLATION TOOL FOR KVG-350	ASI DEALER
ASI-36-1U		696-4845-00	BRUSH SPREADER FOR KVG-350	ASI DEALER
ASI-36-4A		830-6984-001	PLATE: STANDBY SUPPORT	ASI DEALER
ASI-36-4B		830-6984-002	BLOCK: LCD WEIGHT	ASI DEALER
ASI-37-0A		641-6468-002	CABLE: ASI-370 TO ANT-462	ASI DEALER
ASI-37-2B			CABLE: ASI-372 TO 332C-8 INDICATOR	ASI DEALER
ASI-37-2C			CABLE: ASI-372 TO ANGLE POSITION INDICATOR (SR-103 OR EQUIV)	ASI DEALER
ASI-37-3A		641-5761-001	CABLE: ASI-373 TO VHF-22	ASI DEALER
ASI-37-3B		641-6133-002	CABLE: ASI-373 TO VHF-422S	ASI DEALER
ASI-37-3C		638-0524-001	CABLE: ASI-373 TO VHF-20/21	ASI DEALER
ASI-37-5A		659-3486-001	CABLE: ASI-375 TO ADF RECEIVER AND CONTROL (W1)	ASI DEALER
ASI-37-5B		659-3483-001	CABLE: ASI-375 TO ADF ANTENNA (W2)	ASI DEALER
ASI-37-5C		687-7724-001	FIXTURE: RF ATTENUATOR	ASI DEALER
ASI-37-5D		687-7931-001	FIXTURE: MIL-STD-1553B BUS ADAPTER	ASI DEALER
ASI-37-6A		659-3597-001	CABLE: ASI-376 I/O (W1)	ASI DEALER
ASI-37-6B1		659-3598-001	CABLE: ASI-376 MB (W2)	ASI DEALER
ASI-37-6B2		659-3598-002	CABLE: ASI-376 RF (W3)	ASI DEALER
ASI-37-6B3		659-3598-003	CABLE: ASI-376 NR (W6)	ASI DEALER
ASI-37-6B4		659-3598-004	CABLE: ASI-376 GS (W7)	ASI DEALER
ASI-37-6C		659-3603-001	CABLE: ASI-376 CONTROL (W4)	ASI DEALER
ASI-37-6D		659-3933-001	1553 BUS ADAPTER	ASI DEALER
ASI-37-6E		676-6722-001	CABLE: ASI-37-6D TO ATLANTIS DCM-1553	ASI DEALER
ASI-37-6E1			CABLE: ASI-37-6E TO VCT-186B / RT1300B/ARC-186(V) / RT-1300C/ARC-186(V)	ASI DEALER
ASI-37-9A		653-2360-001	CABLE: ASI-379 TO EFIS	ASI DEALER
ASI-37-9B		653-2361-001	CABLE: ASI-379 TO WXP-4000	ASI DEALER
ASI-37-9C		653-2362-001	CABLE: ASI-379 TO STD-7000	ASI DEALER
ASI-37-77A			CABLE: 978F-3M AND 978F-2S TO 614E-10() (FIG 1002)	ASI DEALER
ASI-38-1A			EXTENDER CABLE: ADS-65C A2 (QTY 2 REQUIRED FOR TESTING LRU)	ASI DEALER
ASI-38-1B			EXTENDER CABLE: ADS-65C A3 (QTY 2 REQUIRED FOR TESTING LRU)	ASI DEALER
ASI-38-2A		641-6388-902	CABLE: ASI-382 TO VIR-32	ASI DEALER
ASI-38-2B		641-6388-903	CABLE: ASI-382 TO VIR-432	ASI DEALER
ASI-38-6A		641-5834-005	CABLE: ASI-386 TO AHC-85	ASI DEALER
ASI-38-8A			CABLE: FCC-85/86 ARINC 429 INTERFACE (FCC-85.86 MAN FIG 908)	ASI DEALER
ASI-39-4A			CABLE: HPU-74 EXTENDER (HPU-74 MAN FIG 5-5)	ASI DEALER
ASI-39-5A			CABLE: CTS-74 A4 POWER EXTENDER (CTS-74 MAN FIG 5-3)	ASI DEALER
ASI-39-11A			CABLE: AHC-85 TO CTC-429 INTEGRATION CABLE (AHC-85 MAN FIG 907)	ASI DEALER
ASI-40-1A			CABLE KIT: ASI-10-401A THRU ASI-10-401G (PART OF ASI-401-1)	ASI DEALER
ASI-40-1B			CABLE KIT: ASI-10-401E THRU ASI-10-401H (PART OF ASI-401-2)	ASI DEALER
ASI-40-1C			CABLE KIT: ASI-10-401I THRU ASI-10-401O (PART OF ASI-401-3)	ASI DEALER
ASI-40-3A		634-4242-001	CABLE: ASI-403 (972S-5) TO SVO-75	ASI DEALER
ASI-40-3B		634-2226-001	CABLE: ASI-403 (972S-5) TO SVO-85A(-001/101)-85B(-001/101)-85C(-003/103)	ASI DEALER
ASI-40-3C		634-2226-002	CABLE: ASI-403 (972S-5) TO SVO-85A(-002/-102)-85B(-002/102)-85C(-004/-104)	ASI DEALER
ASI-40-3D		634-2226-003	CABLE: ASI-403 (972S-5) TO SVO-3000	ASI DEALER
ASI-40-3E		653-1288-002	CABLE: ASI-403 (972S-5) TO SVO-1000	ASI DEALER
ASI-40-3F		628-8888-001	CABLE: ASI-403 (972S-5) TO SVO-85B (-003)	ASI DEALER
ASI-40-31A			SMT-87 CAPSTAN TORQUE ADJUSTMENT FIXTURE	ASI DEALER
ASI-40-31B		634-1729-001	SERVO CLUTCH DEPTH GAUGE FOR SVO-85 (REQ USER SUPPLIED 25-243J/6632-5)	ASI DEALER
ASI-40-31B1			SERVO CLUTCH DEPTH GAUGE FOR SVO-1000 (REQ USER SUPPLIED 25-243J/6632-5)	ASI DEALER
ASI-40-31C		634-1728-001	MOUNT CLUTCH DEPTH GUIDE FOR SVO-85 (REQ USER SUPPLIED 25-243J/6632-5)	ASI DEALER
ASI-40-31C1			MOUNT CLUTCH DEPTH GUIDE FOR SVO-1000 (REQ USER SUPPLIED 25-243J/6632-5)	ASI DEALER
ASI-40-31D		634-1772-001	SVO-85/1000 / TSM-1000 BACKLASH TEST FIXTURE (REQ USER SUPPLIED 25-241J)	ASI DEALER
ASI-40-31D1		634-1772-002	SVO-85/1000 / TSM-1000 BACKLASH TEST FIXTURE (INCLUDES 25-241J)	ASI DEALER
ASI-40-31E			SVO-85 SERVO RUN-IN FIXTURE	ASI DEALER
ASI-40-31F			SVO-85/1000 PRELOAD FIXTURE	ASI DEALER
ASI-40-31G			SMT-85/86/1000 PRELOAD FIXTURE	ASI DEALER
ASI-40-31H			SVO-85 PRELOAD ADJUSTMENT SCREW	ASI DEALER
ASI-40-31J		827-2298-001	SVO-85 BRUSH ADJUSTMENT FIXTURE	ASI DEALER
ASI-40-31K			SVO-85 CLUTCH BEARING INSTALLATION TOOL	ASI DEALER

AVAILABILITY:

ASI DEALER: CONTACT ANY ASI DEALER FOR QUOTE
 COLLINS: CONTACT ROCKWELL COLLINS FOR QUOTE
 GABLES: CONTACT GABLES ENGINEERING FOR QUOTE
 TELEPHONICS: CONTACT TELEPHONICS FOR QUOTE

ASI SPECIALIZED TEST EQUIPMENT LIST

AVAILABILITY SUBJECT TO CHANGE WITHOUT NOTICE

<u>ASI MN</u>	<u>EQUIV MN</u>	<u>EQUIV PN</u>	<u>DESCRIPTION</u>	<u>AVAILABILITY</u>
ASI-40-31L			SVO-85 SERVO CLUTCH HALF SUPPORT	ASI DEALER
ASI-40-31M			SVO-85 SERVO MOUNT SUPPORT	ASI DEALER
ASI-40-31N			SVO-85 BALL STAKING TOOL	ASI DEALER
ASI-40-31P			SVO-85 BEARING REMOVAL TOOL	ASI DEALER
ASI-40-31Q			SVO-85 BUSHING SUPPORT	ASI DEALER
ASI-40-31R			SVO-85 BUSHING REMOVAL TOOL	ASI DEALER
ASI-40-31S			SVO-85 PIN INSERTION/REMOVAL PUNCHES	ASI DEALER
ASI-40-31T			SMT-85/86 DRILLING FIXTURE	ASI DEALER
ASI-40-31U			SMT-85/86 PINNING FIXTURE	ASI DEALER
ASI-40-31V			SMT-87 DRILLING FIXTURE	ASI DEALER
ASI-40-31W			SMT-87 PINNING FIXTURE	ASI DEALER
ASI-40-31X			SVO-85/86 DRILLING FIXTURE	ASI DEALER
ASI-40-31Y			SVO-85 PIN REMOVAL/INSERTION FIXTURE	ASI DEALER
ASI-40-31Z			SVO-85 CABLE TENSIONING FIXTURE	ASI DEALER
ASI-40-32A		827-1090-001	SVO-85C/1000 BACKLASH/TORQUE TEST FIXTURE	ASI DEALER
ASI-40-32B1		830-5758-001	TORQUE TEST FIXTURE	ASI DEALER
ASI-40-32B2		830-5758-002	SMT SHAFT FREE PLAY FIXTURE	ASI DEALER
ASI-40-32C			SVO-85 GEAR-CLUSTER BEARING REMOVAL FIXTURE	ASI DEALER
ASI-40-32D		827-2785-001	SVO-85/1000 CLUTCH HALF FORCE TEST TOOL (REQUIRES USER SUPPLIED 25-243)	ASI DEALER
ASI-40-32E			SMT-87 SEAL INSTALLATION TOOL	ASI DEALER
ASI-40-32F			SVO-85 MOTOR END PLAY FIXTURE	ASI DEALER
ASI-40-32G			SVO-85 GEAR MOVEMENT TOOL	ASI DEALER
ASI-40-32H			SVO-1000 SERVO CLUTCH FIXTURE	ASI DEALER
ASI-40-32J			SVO-1000 / BCA-770 PRESSURE CHECK FITTING	ASI DEALER
ASI-40-32K			SVO-1000 GLAND RETAINER	ASI DEALER
ASI-40-32L			SVO-1000 MOUNT LOADING FIXTURE	ASI DEALER
ASI-40-32M		827-3794-001	SVO-1000 EXPANDER FIXTURE	ASI DEALER
ASI-40-32M1		827-3794-002	BCA-770 EXPANDER FIXTURE	ASI DEALER
ASI-40-32N		827-3793-001	SVO-1000 / BCA-770 PUSHER FIXTURE	ASI DEALER
ASI-40-32P		827-3795-001	SVO-1000 COMPRESSOR FIXTURE	ASI DEALER
ASI-40-32P1		827-3795-002	BCA-770 COMPRESSOR FIXTURE	ASI DEALER
ASI-40-32Q		827-2704-001	SVO-1000 SERVO MOUNT HOUSING LEAK CHECK FIXTURE (INCL WITH ASI-40-32S)	ASI DEALER
ASI-40-32R		827-2796-001	SVO-1000 SLIP CLUTCH LEAK CHECK FIXTURE (INCLUDED WITH ASI-40-32S)	ASI DEALER
ASI-40-32S			SVO-1000 SERVO MOUNT PRESSURE LEAK TEST ASSEMBLY	ASI DEALER
ASI-40-41A		676-3871-001	BACKLASH TEST FIXTURE (REQUIRES USER 25-241 DIAL INDICATOR)	ASI DEALER
ASI-40-41B		460-0079-246	BCA-770 SERVO MOUNT PRESSURE LEAK TEST ASSEMBLY	ASI DEALER
ASI-40-41B1		827-1646-001	PRESSURE CHECK FITTING (INCLUDED WITH ASI-40-41B)	ASI DEALER
ASI-40-41B2		827-0332-001	SLIP CLUTCH CHECK FIXTURE (INCLUDED WITH ASI-40-41B)	ASI DEALER
ASI-40-41C		676-3866-001	BCA-770 TORQUE BACKLASH TEST FIXTURE (REQUIRES USER SUPPLIED 25-241J)	ASI DEALER
ASI-40-41D		131-3605-464	BCA-770 OVERRIDE SLIP CLUTCH TEST FIXTURE	ASI DEALER
ASI-40-41E		131-3605-422	BCA-770 MOUNT ASSEMBLY PRELOAD TEST FIXTURE	ASI DEALER
ASI-40-41F		131-3605-423	BCA-770 MOUNT ASSEMBLY FORCE-PULL TEST FIXTURE	ASI DEALER
ASI-40-41G		117-0600-107	BCA-770 MOUNT ASSY DRILLING AND PINNING TEST FIXTURE	ASI DEALER
ASI-40-41H		131-3605-469	BCA-770 MOTOR TENSION ADJUSTER	ASI DEALER
ASI-40S-3A	440S-3A	522-3193-003	CABLE: SENSE ANTENNA	ASI DEALER
ASI-40X-1	440X-1	763-5591-001	CABLE: ASI-40X-10/14 (440X-10/14) TO 562A-5F	ASI DEALER
ASI-40X-2	440X-2	554-2547-001	CABLE: 978F-10R TO 562R-1/1E	ASI DEALER
ASI-40X-3	440X-3	522-4708-001	CABLE: ASI-191 (978F-1D) TO 978F-2S	ASI DEALER
ASI-40X-4	440X-4	522-4709-001	CABLE: ASI-191 (978F-1D) TO 329B-7/329B-8	ASI DEALER
ASI-40X-5	440X-5	522-4710-001	CABLE: ASI-191 (978F-1D) TO 479X-2	ASI DEALER
ASI-40X-6	440X-6	522-4711-001	CABLE: ASI-191 (978F-1D) TO 331A-6/331A-7 (P1)	ASI DEALER
ASI-40X-7	440X-7	522-4712-001	CABLE: ASI-191 (978F-1D) TO 331A-6/331A-7 (P2)	ASI DEALER
ASI-40X-8	440X-8	522-4713-001	CABLE: ASI-191 (978F-1D) TO 331A-6P/331A-6R	ASI DEALER
ASI-40X-9	440X-9	522-4714-001	CABLE: ASI-191 (978F-1D) TO 331A-6A1/331A-6K1	ASI DEALER
ASI-40X-10	440X-10	522-4715-001	CABLE: ASI-191 (978F-1D) TO 331D-3, AQU-2/A	ASI DEALER
ASI-40X-11	440X-11	554-2549-001	CABLE: 978F-11P TO 562P-1/1E1	ASI DEALER
ASI-40X-12	440X-12	554-2547-002	CABLE: 978F-11P TO 562P-1	ASI DEALER
ASI-40X-13	440X-13	522-4716-001	CABLE: 978F-9A TO 562P-1/1E1	ASI DEALER
ASI-40X-14	440X-14	522-4717-001	CABLE: 978F-5R/10R TO 562A-5F	ASI DEALER
ASI-40X-15	440X-15	554-2548-001	CABLE: 978F-10R TO 562R-1/1E	ASI DEALER
ASI-40X-16	440X-16	522-4718-001	CABLE: 978F-9A TO 562R-1/1E	ASI DEALER
ASI-40X-17	440X-17	522-4719-001	CABLE: 978F-3M TO 978F-2S	ASI DEALER
ASI-40X-18	440X-18	522-4720-001	CABLE: 978F-3M TO 614E-7C/8A	ASI DEALER
ASI-40X-19	440X-19	522-4721-001	CABLE: 978F-3M TO 978F-2S TO 614E-8B	ASI DEALER
ASI-40X-20	440X-20	522-4722-001	CABLE: 978F-3M TO 978F-2S TO 614E-9B	ASI DEALER
ASI-40X-21	440X-21	522-4723-001	CABLE: 978F-3M TO 978F-2S TO 614E-9C	ASI DEALER
ASI-40X-22	440X-22	522-4859-001	CABLE: 978F-4A TO 344C-1D	ASI DEALER
ASI-40X-23	440X-23	522-4860-001	CABLE: 978F-3M TO 614E-7()	ASI DEALER
ASI-40Y-1	440Y-1	522-4606-001	980L-1/1A PLUG IN FOR 562C-4/4E	ASI DEALER

AVAILABILITY:

ASI DEALER: CONTACT ANY ASI DEALER FOR QUOTE
 COLLINS: CONTACT ROCKWELL COLLINS FOR QUOTE
 GABLES: CONTACT GABLES ENGINEERING FOR QUOTE
 TELEPHONICS: CONTACT TELEPHONICS FOR QUOTE

ASI SPECIALIZED TEST EQUIPMENT LIST

AVAILABILITY SUBJECT TO CHANGE WITHOUT NOTICE

ASI MN	EQUIV MN	EQUIV PN	DESCRIPTION	AVAILABILITY
ASI-40Y-2	440Y-2	522-4607-001	980L-1/1A PLUG IN FOR 562C-5G	ASI DEALER
ASI-40Y-3	440Y-3	522-4609-001	980L-1/1A PLUG IN 161A-1, 332G-2, 345A-4 ,590A-3 ,590B-2, 614E-2	ASI DEALER
ASI-40Y-5	440Y-5	522-4899-001	980L-1/1A PLUG IN FOR 562A-5F/5F1/5F2/5F3/5F4/5F5	ASI DEALER
ASI-40Y-6	440Y-6	522-4900-001	980L-1/1A PLUG IN FOR 344C-1F/1G	ASI DEALER
ASI-40Y-7	440Y-7	522-4944-001	980L-1/1A PLUG IN FOR 161E-1	ASI DEALER
ASI-40Y-8	440Y-8	522-4957-001	980L-1/1A PLUG IN FOR 344C-1D	ASI DEALER
ASI-40Y-9	440Y-9	522-4958-001	980L-1/1A PLUG IN FOR 562P-1/1E1/1F, 562R-1/1E/1F	ASI DEALER
ASI-40Y-11	440Y-11	522-4960-001	980L-1/1A PLUG IN FOR 161F-1/1A/1B, 345C-2A	ASI DEALER
ASI-40Y-11-1		797-7008-001	345C-2A ACCELERATION SENSOR POS FIXTURE (345C-2A MANUAL FIGURE 1005)	ASI DEALER
ASI-40Y-12	440Y-12	522-4961-001	980L-1/1A PLUG IN FOR 54W-1/1B/1C/1D/1E/1F	ASI DEALER
ASI-40Y-13	440Y-13	522-4962-001	980L-1/1A PLUG IN FOR 614E-7()/8B/9B/9C/9E/9G/10()/11/11A	ASI DEALER
ASI-40Y-14	440Y-14	522-4963-001	980L-1/1A PLUG IN FOR 344C-1E/1K	ASI DEALER
ASI-40Y-15	440Y-15	522-4964-001	980L-1/1A PLUG IN FOR 562A-5M/5M5	ASI DEALER
ASI-40Y-16	440Y-16	777-1035-001	980L-1/1A PLUG IN FOR 562C-4A	ASI DEALER
ASI-40Y-17	440Y-17	777-1036-001	980L-1/1A PLUG IN FOR 590A-5, 614E-4/4B	ASI DEALER
ASI-40Y-19	440Y-19	777-1038-001	980L-1/1A PLUG IN FOR 331A-8G/8H, 614E-22/22B	ASI DEALER
ASI-40Y-20	440Y-20	777-1039-001	980L-1/1A PLUG IN FOR 161E-2, 614E-20/20A/20D/20E/20J/20K/23	ASI DEALER
ASI-40Y-23	440Y-23	777-1042-001	980L-1/1A PLUG IN FOR 331A-8A/8D/8K/9G	ASI DEALER
ASI-40Y-23AB			ADAPTER BOX: 440Y-23 TO 331A-9G, HSI-45	ASI DEALER
ASI-40Y-24	440Y-24	777-1043-001	980L-1/1A PLUG IN FOR 54W-3/3A/3B	ASI DEALER
ASI-40Y-25	440Y-25	777-1044-001	980L-1/1A PLUG IN FOR MC-103, 323A-1/5, 332C-8, 332E-5	ASI DEALER
ASI-40Y-26	440Y-26	777-1919-001	980L-1/1A PLUG IN FOR 161E-7A	ASI DEALER
ASI-40Y-27	440Y-27	787-6073-001	980L-1/1A PLUG IN FOR 562C-3E	ASI DEALER
ASI-40Y-29	440Y-29	787-6138-001	980L-1/1A PLUG IN FOR 188M-1, 327J-3	ASI DEALER
ASI-40Y-30	440Y-30	787-6139-001	980L-1/1A PLUG IN FOR 161E-6	ASI DEALER
ASI-40Y-31	440Y-31	787-6140-001	980L-1/1A PLUG IN FOR 614E-4C/27/36	ASI DEALER
ASI-40Y-33	440Y-33	787-6142-001	980L-1/1A PLUG IN FOR 329B-8J/8V/9A/8Y	ASI DEALER
ASI-40Y-33-1		637-6079-001	ADAPTER CABLE	ASI DEALER
ASI-40Y-33-2			FABRICATED TEST CABLE FOR 440Y-33 / ASI-40Y-33	ASI DEALER
ASI-40Y-34	440Y-34	787-6143-001	980L-1/1A PLUG IN FOR 54W-4	ASI DEALER
ASI-40Y-35	440Y-35	787-6144-001	980L-1/1A PLUG-IN FOR 161E-7B	ASI DEALER
ASI-40Y-36	440Y-36	787-6810-001	980L-1/1A PLUG IN FOR 329B-8G	ASI DEALER
ASI-40Y-38	440Y-38	792-6383-001	980L-1/1A PLUG IN FOR 562C-5, 562C-8A/8B, 614E-5A/5C	ASI DEALER
ASI-40Y-39	440Y-39	792-6384-001	980L-1/1A PLUG IN FOR 161E-2A, 614E-20G/20H/20I/23E/23G	ASI DEALER
ASI-40Y-43	440Y-43	792-6889-001	980L-1/1A PLUG IN FOR 329B-8L/8R/8U/8Z	ASI DEALER
ASI-40Y-67A	440Y-67A	622-4086-001	980L-1A PLUG IN FOR FGC-80(), FGP-80(), FGP-81(), NAC-80	ASI DEALER
ASI-40Y-67A-1			FGP-80/81 DIODE TESTER (FGP-80/81 MANUAL FIGURE 5-4, 5-5)	ASI DEALER
ASI-40Y-67A-2			FGC-80 TEST EXPEDITER (FGC-80 MANUAL FIGURE 5-5)	ASI DEALER
ASI-40Y-68A	440Y-68A	622-4087-001	980L-1A PLUG IN FOR APC-80(), APP-80()	ASI DEALER
ASI-40Y-69A	440Y-69A	622-4088-001	980L-1A PLUG IN FOR APA-80(), SVO-80()	ASI DEALER
ASI-40Y-69A-1			ROLL RATE TEST FIXTURE FOR 440Y-69A	ASI DEALER
ASI-40Y-76	440Y-76	622-6315-001	980L-1A PLUG-IN FOR APS-65/FGS-65	ASI DEALER
ASI-40Y-76-01			CABLE: ANN PWR ADAPTER (P/O ASI-40Y-76 PER SB8)	ASI DEALER
ASI-40Y-76-02			APP-65 ANNUNCIATOR TEST BOX (P/O ASI-40Y-76 PER SB8)	ASI DEALER
ASI-40Y-76-1	ASI-354-1		APC-65/FCC-65 SERVO EMULATOR	ASI DEALER
ASI-40Y-76-2	ASI-354-2		APC-65/FCC-65 SERVO ANGLE INDICATOR	ASI DEALER
ASI-40Y-76-3	ASI-35-41E		CABLE: FRONT EXTENDER FOR APC-65/FGC-65)	ASI DEALER
ASI-40Y-76-4	ASI-35-41B		CABLE: REAR 36 PIN EXTENDER FOR APC-65/FGC-65	ASI DEALER
ASI-40Y-76-5	ASI-35-41C		CABLE: REAR 30 PIN EXTENDER FOR APC-65/FGC-65	ASI DEALER
ASI-40Y-76-6	ASI-35-41D		CABLE: REAR 26 PIN EXTENDER FOR APC-65/FGC-65	ASI DEALER
ASI-40Y-76-7	ASI-35-41A		CABLE: 440Y-76 TO PRO LINE II CARD (APC-65/FGC-65)	ASI DEALER
ASI-40Y-76-8			APC-65E TRIM INTERFACE PANEL	ASI DEALER
ASI-40Y-76-81			MAP-65 TEST FIXTURE	ASI DEALER
ASI-40Y-76-9			CWC-65 TEST SET (CWC-65 MAN FIG 5-2 - 5-3)	ASI DEALER
ASI-40Y-76-10		827-9736-001	APC-65 GYRO MONITOR TEST SET	ASI DEALER
ASI-41-2A		634-3381-001	CABLE: ASI-412 (CTS-64) P1	ASI DEALER
ASI-41-2B		634-3474-001	CABLE: ASI-412 (CTS-64) P2	ASI DEALER
ASI-41-2C		634-7452-001	CABLE: ASI-412 (CTS-64) EMULATOR	ASI DEALER
ASI-41-2D		634-3476-001	CABLE: ASI-412 (CTS-64) P4	ASI DEALER
ASI-41-2E		634-3477-001	CABLE: ASI-412 (CTS-64) P5	ASI DEALER
ASI-41-2F		634-3478-001	CABLE: ASI-412 (CTS-64) P6	ASI DEALER
ASI-41-2G		634-3480-001	CABLE: ASI-412 (CTS-64) P7	ASI DEALER
ASI-41-2H		634-3482-001	CABLE: ASI-412 (CTS-64) P9	ASI DEALER
ASI-41-2I		653-1078-001	CABLE: ASI-412 (CTS-64) P10	ASI DEALER
ASI-41-2J		634-3483-001	CABLE: ASI-412 (CTS-64) J1	ASI DEALER
ASI-41-3A		2038683-0505	CABLE: ASI-413-1 (RIT-32A) W101	ASI DEALER
ASI-41-5A			ADC POWER SUPPLY LOAD FIXTURE	ASI DEALER
ASI-41-5B			AL/MS/VI/PI POINTER ALIGNMENT FIXTURE	ASI DEALER
ASI-41-6A			CABLE: ASI-416 TO SQUAWK NAUT	ASI DEALER

AVAILABILITY:

ASI DEALER: CONTACT ANY ASI DEALER FOR QUOTE
 COLLINS: CONTACT ROCKWELL COLLINS FOR QUOTE
 GABLES: CONTACT GABLES ENGINEERING FOR QUOTE
 TELEPHONICS: CONTACT TELEPHONICS FOR QUOTE

ASI SPECIALIZED TEST EQUIPMENT LIST

AVAILABILITY SUBJECT TO CHANGE WITHOUT NOTICE

ASI MN	EQUIV MN	EQUIV PN	DESCRIPTION	AVAILABILITY
ASI-41-7A		653-1115-001	CABLE: ASI-417 TO EFD-85/-86	ASI DEALER
ASI-41-7B		653-1116-001	CABLE: ASI-417 TO MFD-85	ASI DEALER
ASI-41-7C		827-2935-001	CABLE: ASI-417 TO EFD-74	ASI DEALER
ASI-41-9A			CABLE: ASI-419 P20/21-P40	ASI DEALER
ASI-41-9B			CABLE: ASI-419 P30-P50	ASI DEALER
ASI-41-9C			CABLE: ASI-419 J10-PWR	ASI DEALER
ASI-41-22D			DGS-65 GYRO COVER REMOVAL TOOL (DGS-65 MAN FIG 5-16)	ASI DEALER
ASI-41-22E			DGS-65 END CAP PULLER (DGS-65 MAN FIG 5-17)	ASI DEALER
ASI-41-22F			DGS-65 FAN PULLER (DGS-65 MAN FIG 5-18)	ASI DEALER
ASI-41-22G			DGS-65 BALANCING FIXURE (DGS-65 MAN FIG 5-19)	ASI DEALER
ASI-41-22H			DGS-65 CALIBRATED MOTOR (DGS-65 MAN FIG 5-20)	ASI DEALER
ASI-41-22J			DGS-65 MODIFIED DRILL BIT (DGS-65 MAN FIG 5-21)	ASI DEALER
ASI-41-22K			DGS-65 DEGREE TAPE (DGS-65 MAN FIG 5-22)	ASI DEALER
ASI-41-22L			DGS-65 MOTOR RUN-IN STAND (DGS-65 MAN FIG 5-23)	ASI DEALER
ASI-41-22M			DGS-65 PRELOAD FIXTURE (DGS-65 MAN FIG 5-24)	ASI DEALER
ASI-41-22N			DGS MODIFIED CAP (DGS-65 MAN FIG 5-25)	ASI DEALER
ASI-41-22P			DGS-65 RUNDOWN FIXTURE (DGS-65 MAN FIG 5-26)	ASI DEALER
ASI-41-22Q			DGS-65 SLIPRING REMOVAL TOOL (DGS-65 MAN FIG 5-27)	ASI DEALER
ASI-42-01A		2039388-0501	CABLE: ASI-420-1 (RNT-34A) W1	ASI DEALER
ASI-42-01B		2039389-0501	CABLE: ASI-420-1 (RNT-34A) W2	ASI DEALER
ASI-42-01C		2039446-0501	CABLE: ASI-420-1 (RNT-34A) W3	ASI DEALER
ASI-42-4A		2038692-0501	CABLE: ASI-424-1 (RVT-33A) W101	ASI DEALER
ASI-42-6A		8072585-0501	CABLE: ASI-426 TO DA-1503A (W1)	ASI DEALER
ASI-42-6B		8072586-0501	CABLE: ASI-426 TO DC POWER (W2)	ASI DEALER
ASI-42-6C		8072587-0501	CABLE: ASI-426 TO IU-1507A (W3)	ASI DEALER
ASI-42-6D		8072588-0501	CABLE: ASI-426 TO MT-1508A (W4)	ASI DEALER
ASI-42-6E		8072589-0501	CABLE: ASI-426 TO DA-1203A (W5)	ASI DEALER
ASI-42-6F		8072590-0501	CABLE: ASI-426 TO CC-2024 (W6)	ASI DEALER
ASI-42-6G		8072591-0501	CABLE: ASI-426 TO IN-1502A (W7)	ASI DEALER
ASI-42-6H		2040020-0501	CABLE: ASI-426 TO AC POWER (W8)	ASI DEALER
ASI-42-6J		8072594-0501	CABLE: ASI-426 TO RT-1501A (W9)	ASI DEALER
ASI-42-6K		8072622-0501	CABLE: ASI-426 TO IN-1502B (W10)	ASI DEALER
ASI-42-6L			IN-1502A LVPS LOAD	ASI DEALER
ASI-42-6M			MUMETAL SHIELD	ASI DEALER
ASI-42-31A		2040661-0501	CABLE: ASI-423-1 (IUT-1SB) W4	ASI DEALER
ASI-42-31B		2040662-0501	CABLE: ASI-423-1 (IUT-1SB) W6	ASI DEALER
ASI-42-31C		2040663-0501	CABLE: ASI-423-1 (IUT-1SB) W7	ASI DEALER
ASI-42-31D		2040840-0501	CABLE: ASI-423-1 (IUT-1SB) W8	ASI DEALER
ASI-43-2A		653-1175-001	CABLE: ASI-432 (CTS-88) TO RS-232 TERMINAL (P/O ASI-432)	ASI DEALER
ASI-43-2B		653-1176-001	CABLE: ASI-432 (CTS-88) TO RS-232 TERMINAL (P/O ASI-432)	ASI DEALER
ASI-43-2C		653-1177-001	CABLE: ASI-432 (CTS-88) TO AHC-85 P2 (P/O ASI-432)	ASI DEALER
ASI-43-2D		653-1178-001	CABLE: ASI-432 (CTS-88) TO AHC-85 P1 (P/O ASI-432)	ASI DEALER
ASI-43-2E		634-3474-001	CABLE: ASI-432 (CTS-88) TO RCP/CCU-65 (P/O ASI-432)	ASI DEALER
ASI-43-2F		634-3479-001	CABLE: ASI-432 (CTS-88) TO FDU-70 (P/O ASI-432)	ASI DEALER
ASI-43-2G	ASI-3109-002	653-4242-001	CABLE: ASI-432 (CTS-88) TO AHC-3000	ASI DEALER
ASI-43-2H			CABLE: ASI-432 (CTS-88) TO CTC-429 (AHC-3000 MAN FIG 904)	ASI DEALER
ASI-43-2J			CABLE: ASI-432 (CTS-88) TO ISA COMPUTER (AHC-3000 MAN FIG 905)	ASI DEALER
ASI-43-41C		797-0445-001	CABLE: ASI-434-X TO 860F-1	ASI DEALER
ASI-48-8A			CABLE: ASI-488 RF	ASI DEALER
ASI-49-5C			CABLE: KRA-405B TO COMPUTER (PC)	ASI DEALER
ASI-49-94A		545-4559-003	CABLE: ASI-499-1/2/4 TO EXTERNAL POWER	ASI DEALER
ASI-49-94B		545-4604-004	CABLE: ASI-499-1/2/4 TO HSI AMPLIFIER	ASI DEALER
ASI-49-94C		545-4605-004	CABLE: ASI-499-1/2/4 TO AIRCRAFT INSTRUMENT WIRING	ASI DEALER
ASI-49-94D		545-4607-004	CABLE: ASI-499-1/2/4 TO HSI 1J2	ASI DEALER
ASI-49-94E		545-4609-004	CABLE: ASI-499-1/2/4 TO HSI 1J1	ASI DEALER
ASI-49-94F		546-8436-003	CABLE: ASI-499-2/4 TO AIRCRAFT INSTRUMENT WIRING	ASI DEALER
ASI-49-94G1		548-9600-004	CABLE: ASI-499-2 TO AQU-2/A	ASI DEALER
ASI-49-94G2		756-7400-001	CABLE: ASI-499-4 TO AQU-2/A / AQU-4/A	ASI DEALER
ASI-49-96A		545-4557-003	CABLE: ASI-499-6 (476E-1A) POWER (NO.1)	ASI DEALER
ASI-49-96B		545-4596-003	CABLE: ASI-499-6 (476E-1A) TO 476C-2 (NO.2)	ASI DEALER
ASI-49-96C		545-4615-004	CABLE: ASI-499-6 (476E-1A) TO CPU-4A (NO.3)	ASI DEALER
ASI-49-96D		545-4616-004	CABLE: ASI-499-6 (476E-1A) TO CPU-4A AND INDICATOR (NO.4)	ASI DEALER
ASI-49-96E		545-2501-003	CABLE: ASI-49-96C CABLE TO CPU-4A (NON-COLLINS) (NO.5)	ASI DEALER
ASI-50-2A			ADAPTER: ASI-502 TO ASI-500-1/2 COMM/DME/NAV CABLE	ASI DEALER
ASI-50-2B			ADAPTER: ASI-502 TO ASI-500-1 ADF/ATC/613L-3 CABLE	ASI DEALER
ASI-50-2C			ADAPTER: ASI-502 TO CTL-20 CABLE	ASI DEALER
ASI-50-2D			ADAPTER: ASI-502 TO CTL-30 CABLE	ASI DEALER
ASI-50-2E			ADAPTER: ASI-502 TO CTL-60 CABLE	ASI DEALER
ASI-50-2F			ADAPTER: ASI-502 TO CTL-90 CABLE	ASI DEALER

AVAILABILITY:

ASI DEALER: CONTACT ANY ASI DEALER FOR QUOTE
 COLLINS: CONTACT ROCKWELL COLLINS FOR QUOTE
 GABLES: CONTACT GABLES ENGINEERING FOR QUOTE
 TELEPHONICS: CONTACT TELEPHONICS FOR QUOTE

ASI SPECIALIZED TEST EQUIPMENT LIST

AVAILABILITY SUBJECT TO CHANGE WITHOUT NOTICE

<u>ASI MN</u>	<u>EQUIV MN</u>	<u>EQUIV PN</u>	<u>DESCRIPTION</u>	<u>AVAILABILITY</u>
ASI-50-2G			ADAPTER: ASI-502 TO CTL-22/22A/22C CABLE	ASI DEALER
ASI-50-2H			ADAPTER: ASI-502 TO CTL-23/23C/32/32A CABLE	ASI DEALER
ASI-50-2J			ADAPTER: ASI-502 TO CTL-62/62A CABLE	ASI DEALER
ASI-50-2K			ADAPTER: ASI-502 TO CTL-92/92A CABLE	ASI DEALER
ASI-50-2L			ADAPTER: ASI-502 TO CTL-92T CABLE	ASI DEALER
ASI-50-2M			ADAPTER: ASI-502 TO 313N-4D CABLE	ASI DEALER
ASI-50-2N			ADAPTER: ASI-502 TO 614L-11/12/13 CABLE	ASI DEALER
ASI-50-2P			INTERNATIONAL INPUT POWER ADAPTER FOR ASI-502 (90-265 VAC 47-63 Hz)	ASI DEALER
ASI-50-2P1			STANDARD INPUT POWER ADAPTER FOR ASI-502 (115 VAC 60 Hz)	ASI DEALER
ASI-50-2Q			ADAPTER: ASI-502 TO HF-230 (REQUIRES OPTIONAL HF-230 PROGRAM)	ASI DEALER
ASI-52-1			CABLE: 52 PIN 4 FT EXTENDER (LEFT) PART 1 OF 2 CABLE SET	ASI DEALER
ASI-52-2			CABLE: 52 PIN 4 FT EXTENDER (RIGHT) PART 2 OF 2 CABLE SET	ASI DEALER
ASI-52-3			CABLE: 52 PIN 4 FT EXTENDER CABLE (WITHOUT TEST POINTS)	ASI DEALER
ASI-55-0605-13		55-0605-13	CABLE: PSD60-1AF BNC TO TEST CLIP (36")	ASI DEALER
ASI-55-0605-14		55-0605-14	CABLE: PSD60-1AF BNC TO ALIGATOR CLIP (36")	ASI DEALER
ASI-55-0605-15		55-0605-15	CABLE: PSD60-1AF BNC TO BNC (48")	ASI DEALER
ASI-55-0605-16		55-0605-16	CABLE: PSD60-1AF BNC TO RP BNC (36")	ASI DEALER
ASI-55-7002-00		55-7002-00	CABLE: PSD60-1AF BANANA PLUG TO ALLIGATOR CLIP	ASI DEALER
ASI-60-1			CABLE: 60 PIN 4 FT EXTENDER (LEFT) PART 1 OF 3 CABLE SET	ASI DEALER
ASI-60-2			CABLE: 60 PIN 4 FT EXTENDER (RIGHT) PART 2 OF 3 CABLE SET	ASI DEALER
ASI-60-3			CABLE: 60 PIN 4 FT EXTENDER (30 LEFT,30 RIGHT) PART 3 OF 3 CABLE SET	ASI DEALER
ASI-60-4			CABLE: 60 PIN 4 FT EXTENDER CABLE (WITHOUT TEST POINTS)	ASI DEALER
ASI-60-33A		988-8192-001	CABLE: ASI-603-3 (964B-3) SPECIAL PURPOSE	ASI DEALER
ASI-60-33B		988-8193-001	CABLE: ASI-603-3 (964B-3) SPECIAL PURPOSE	ASI DEALER
ASI-60-33C		988-8194-001	CABLE: ASI-603-3 (964B-3) SPECIAL PURPOSE	ASI DEALER
ASI-60-41A			CABLE: ASI-604-1 TO 263BC101 J1	ASI DEALER
ASI-60-41B			CABLE: ASI-604-1 TO 263BC101 TB1	ASI DEALER
ASI-60-41C			CABLE: ASI-604-1 TO BATTERY SIMULATOR	ASI DEALER
ASI-60-41D		263TS302-1	CABLE: 263BC101 A2P1 EXTENDER	ASI DEALER
ASI-60-41E		263TS303-1	CABLE: 263BC101 A2J1 EXTENDER	ASI DEALER
ASI-60-41F			CABLE: ASI-604-1 TO 263BA101	ASI DEALER
ASI-60-5			60 PIN BREAKOUT BOX FOR EFIS 85/86 AND APS-85 (REQ ASI-60-5-XX CABLE KITS)	ASI DEALER
ASI-60-5-15			DA-15 BREAKOUT CABLE KIT FOR USE WITH ASI-60-5 (INCLUDES 2 CABLES)	ASI DEALER
ASI-60-5-25			DB-25 BREAKOUT CABLE KIT FOR USE WITH ASI-60-5 (INCLUDES 2 CABLES)	ASI DEALER
ASI-60-5-37			DC-37 BREAKOUT CABLE KIT FOR USE WITH ASI-60-5 (INCLUDES 2 CABLES)	ASI DEALER
ASI-60-5-50			DD-50 BREAKOUT CABLE KIT FOR USE WITH ASI-60-5 (INCLUDES 2 CABLES)	ASI DEALER
ASI-60-4984-1		60-4984-1	CABLE, 60-4983-3 / -5 STROBE POWER SUPPLY TO TEST LIGHT	ASI DEALER
ASI-60-4984-2			CABLE, 60-4983-3 / -5 STROBE POWER SUPPLY TO TEST POWER	ASI DEALER
ASI-61	HTS-61	2900-00061-000	ADF ANTENNA SIMULATOR (19 INCH RACK MOUNT CASE)	ASI DEALER
ASI-61W	970W-1	622-3099-001	ADF ANTENNA SIMULATOR (CONTROL HEAD CASE) / REPLACES ASI-186	ASI DEALER
ASI-70-1			CABLE: PRO LINE 21 (66 CONTACT / 4 COAX) EXTENDER	ASI DEALER
ASI-70-0XA			CABLE: ASI-700-2/-3/-4 TO T1200()	ASI DEALER
ASI-70-02A			CABLE: ASI-700-2 TO ADF-700 / ADF-900 / DFA-75A	ASI DEALER
ASI-70-02A1			OVERLAY: ADF-700	ASI DEALER
ASI-70-02A2			OVERLAY: ADF-900	ASI DEALER
ASI-70-02A3			OVERLAY: DFA-75A	ASI DEALER
ASI-70-02B			CABLE: ILS-700 / ILS-720 / ILS-900 / RIA-35A	ASI DEALER
ASI-70-02B1			OVERLAY: ILS-700	ASI DEALER
ASI-70-02B2			OVERLAY: ILS-720	ASI DEALER
ASI-70-02B3			OVERLAY: RIA-35A	ASI DEALER
ASI-70-02B4			OVERLAY: ILS-900	ASI DEALER
ASI-70-02C			CABLE: VOR-700 / VOR-900 / RVA-36A	ASI DEALER
ASI-70-02C1			OVERLAY: VOR-700	ASI DEALER
ASI-70-02C2			OVERLAY: VOR-900	ASI DEALER
ASI-70-02C3			OVERLAY: RVA-36A	ASI DEALER
ASI-70-02D			CABLE: GLU-910 (WITHOUT RF)	ASI DEALER
ASI-70-02D1			OVERLAY: GLU-9X0	ASI DEALER
ASI-70-02E			CABLE: GLU-920 (WITH RF)	ASI DEALER
ASI-70-02F			ILS-700/720 GLIDESLOPE FILTER (FIG 903)	ASI DEALER
ASI-70-02G			ILS-700/720 POWER SUPPLY A8 EXTENSIONS (INCLUDES 3 CABLES)	ASI DEALER
ASI-70-02H			ILS-700 LOADING TOOL (FIG. 908)	ASI DEALER
ASI-70-02J			ILS-720 A1A18 EXTENSION BLOCK (FIG 905)	ASI DEALER
ASI-70-02K			DFA-701/901 INTERCONNECT TEST CABLE (FIG 103)	ASI DEALER
ASI-70-02L			CABLE: 115 VAC 400 HZ INPUT POWER ISOLATION (REQUIRED FOR ADF-900 TESTING)	ASI DEALER
ASI-70-02M			DFA-701/901 PCB TEST SET	ASI DEALER
ASI-70-03A			CABLE: DME-700 / DME-900	ASI DEALER
ASI-70-03A1			OVERLAY: DME-700	ASI DEALER
ASI-70-03A2			OVERLAY: DME-900	ASI DEALER
ASI-70-03A3			OVERLAY: DMA-37A	ASI DEALER

AVAILABILITY:

ASI DEALER: CONTACT ANY ASI DEALER FOR QUOTE
 COLLINS: CONTACT ROCKWELL COLLINS FOR QUOTE
 GABLES: CONTACT GABLES ENGINEERING FOR QUOTE
 TELEPHONICS: CONTACT TELEPHONICS FOR QUOTE

ASI SPECIALIZED TEST EQUIPMENT LIST

AVAILABILITY SUBJECT TO CHANGE WITHOUT NOTICE

<u>ASI MN</u>	<u>EQUIV MN</u>	<u>EQUIV PN</u>	<u>DESCRIPTION</u>	<u>AVAILABILITY</u>
ASI-70-03B			CABLE: LRA-700 / LRA-900	ASI DEALER
ASI-70-03B1			OVERLAY: LRA-700	ASI DEALER
ASI-70-03B2			OVERLAY: LRA-900	ASI DEALER
ASI-70-03C			CABLE: ERT-530	ASI DEALER
ASI-70-03C1			OVERLAY: ERT-530	ASI DEALER
ASI-70-03D			LRA-900 RF TRANSMITTER TOOL	ASI DEALER
ASI-70-04A			CABLE: VHF-700 / VHF-700A	ASI DEALER
ASI-70-04A1			OVERLAY: VHF-700 / VHF-700A	ASI DEALER
ASI-70-04A2			OVERLAY: RTA-44A	ASI DEALER
ASI-70-04B			CABLE: HFS-700/900 / 628T-2/2A	ASI DEALER
ASI-70-04B1			OVERLAY: HFS-700/900 / 628T-2/2A	ASI DEALER
ASI-70-04C			ARINC 753 INTERFACE PANEL: ASI-700-4 TO 628T-2D / HFS-700D/900D	ASI DEALER
ASI-70-04C1			CABLE: CPL-920D / 490S-1 J1 (INCLUDED WITH ASI-70-04C)	ASI DEALER
ASI-70-04D			CABLE: VHF-900 (TEST POINT OVERLAY NOT REQUIRED)	ASI DEALER
ASI-70-04D1			OVERLAY	ASI DEALER
ASI-70-04E			CABLE: 628T-1	ASI DEALER
ASI-70-04E1			OVERLAY: 628T-1	ASI DEALER
ASI-70-04F			CABLE: 490S-1 (REPLACED BY ASI-70-04C1)	ASI DEALER
ASI-70-04G			CABLE: 714E-1	ASI DEALER
ASI-70-04H			CABLE: 714E-2	ASI DEALER
ASI-70-04J			CABLE: 714E-3/6	ASI DEALER
ASI-70-04K			CABLE: ASI-700-4 ARINC INTERFACE PLUG TO ASI-502	ASI DEALER
ASI-70-04L			CABLE: HFS-900 (REPLACED BY ASI-70-04B)	ASI DEALER
ASI-70-04L1			OVERLAY: HFS-900 (REPLACED BY ASI-70-04B1)	ASI DEALER
ASI-70-04M			HFS-700D VOLTAGE REGULATOR A6A3 TESTER (REPLACED BY ASI-700-4-07)	ASI DEALER
ASI-70-04N			CABLE: HFS-900D (REPLACED BY ASI-70-04C)	ASI DEALER
ASI-70-04N1			OVERLAY: HFS-900D	ASI DEALER
ASI-70-04P			628T-2/2A/HFS-700 A5 ALIGNMENT FIXTURE (628T-2/2A MAN FIG 911-913)	ASI DEALER
ASI-70-04Q1		628-5274-001	VHF-700 ADJUSTMENT COVER	ASI DEALER
ASI-70-04Q2		628-8351-001	VHF-700 ADJUSTMENT COVER	ASI DEALER
ASI-70-04R			RTA-44A SERIES DETECTOR CIRCUIT	ASI DEALER
ASI-70-04S			HFS-900D HFDR DATA LOAD CABLE	ASI DEALER
ASI-70-04T			CABLE: ASI-700-4 TO HFP-712	ASI DEALER
ASI-70-04U			CABLE: RTA-83A	ASI DEALER
ASI-70-04U1			OVERLAY: RTA-83A	ASI DEALER
ASI-70-04V			CABLE: ASI-700-4 TO VHF-920 (ASI-700-4 MUST SN 110 OR ABOVE OR HAVE SB5)	ASI DEALER
ASI-70-1A			CABLE: ASI-CTS-700-1 TO DDI-713	ASI DEALER
ASI-70-1B			CABLE: ASI-CTS-700-1 TO RMI-733	ASI DEALER
ASI-70-1C			CABLE: ASI-CTS-700-1 TO RMI-733A	ASI DEALER
ASI-70-1D			CABLE: ASI-CTS-700-1 TO RDMI-743	ASI DEALER
ASI-70-1E			CABLE: ASI-CTS-700-1 TO RDMI-743 (CPN-622-5001-112)	ASI DEALER
ASI-70-1F			CABLE: ASI-CTS-700-1 TO RDMI-743 (CPN-622-5001-003), RDMI-743A	ASI DEALER
ASI-70-1G			CABLE: ASI-CTS-700-1 TO RAI-742	ASI DEALER
ASI-70-1HA			RDMI-743 EXTENDER KIT (INCLUDES ASI-70-1H1/2/3/4/5/6/7/8/9)	ASI DEALER
ASI-70-1HB			DDI-743 EXTENDER KIT (INCLUDES ASI-70-1H10/11/12/13/14)	ASI DEALER
ASI-70-1HC			RMI-733 EXTENDER KIT (INCLUDES ASI-70-1H20/21/22/23/24/25/26/27/28)	ASI DEALER
ASI-70-1HD			RAI-742 EXTENDER KIT (INCLUDES ASI-70-1H30/31)	ASI DEALER
ASI-70-1H1			CABLE: 46 PIN EXTENDER FOR RDMI-743 A1 TO A7	ASI DEALER
ASI-70-1H2			CABLE: 40 PIN EXTENDER FOR RDMI-743 A1 TO A6	ASI DEALER
ASI-70-1H3			CABLE: 64 PIN EXTENDER FOR RDMI-743 A2/A3 TO A7	ASI DEALER
ASI-70-1H4			CABLE: 52 PIN EXTENDER FOR RDMI-743 A4 TO A7	ASI DEALER
ASI-70-1H5			CABLE: 14 PIN EXTENDER FOR RDMI-743 A5 TO TB1	ASI DEALER
ASI-70-1H6			CABLE: 14 PIN EXTENDER FOR RDMI-743 A5 TO A7	ASI DEALER
ASI-70-1H7			CABLE: 6 PIN EXTENDER FOR RDMI-743 A5 TO A6	ASI DEALER
ASI-70-1H8			CABLE: 50 PIN EXTENDER FOR RDMI-743 A8 TO A7	ASI DEALER
ASI-70-1H9			CABLE: 50 PIN EXTENDER FOR RDMI-743 A9 TO A7	ASI DEALER
ASI-70-1H10			CABLE: 8 PIN EXTENDER FOR DDI-713 A2A1P1 TO A3J1A OR A3P1A TO A4A1J1B	ASI DEALER
ASI-70-1H11			CABLE: 8 PIN EXTENDER FOR DDI-713 A2A1P2 TO A3J2A OR A3P2A TO A4A1J2B	ASI DEALER
ASI-70-1H12			CABLE: 10 PIN EXTENDER FOR DDI-713 A3J6A TO A4A1P6A	ASI DEALER
ASI-70-1H13			CABLE: 10 PIN EXTENDER FOR DDI-713 A3J6B TO A4A1P6B	ASI DEALER
ASI-70-1H14			CABLE: 12 PIN EXTENDER FOR DDI-713 A3J6C TO A2TB1	ASI DEALER
ASI-70-1H20			CABLE: 18 PIN EXTENDER FOR RMI-733 A1 TO A6A1	ASI DEALER
ASI-70-1H21			CABLE: 4 PIN EXTENDER FOR RMI-733 A4A1 TO A6A1	ASI DEALER
ASI-70-1H22			CABLE: 50 PIN EXTENDER FOR RMI-733 A2 TO A7	ASI DEALER
ASI-70-1H23			CABLE: 50 PIN EXTENDER FOR RMI-733 A3 TO A7	ASI DEALER
ASI-70-1H24			CABLE: 14 PIN EXTENDER FOR RMI-733 A4A1 TO A7	ASI DEALER
ASI-70-1H25			CABLE: 34 PIN EXTENDER FOR RMI-733 A1 TO A9	ASI DEALER
ASI-70-1H26			CABLE: 20 PIN EXTENDER FOR RMI-733 A8 TO A9	ASI DEALER
ASI-70-1H27			CABLE: 28 PIN EXTENDER FOR RMI-733 A8 TO A7	ASI DEALER

AVAILABILITY:

ASI DEALER: CONTACT ANY ASI DEALER FOR QUOTE
 COLLINS: CONTACT ROCKWELL COLLINS FOR QUOTE
 GABLES: CONTACT GABLES ENGINEERING FOR QUOTE
 TELEPHONICS: CONTACT TELEPHONICS FOR QUOTE

ASI SPECIALIZED TEST EQUIPMENT LIST

AVAILABILITY SUBJECT TO CHANGE WITHOUT NOTICE

<u>ASI MN</u>	<u>EQUIV MN</u>	<u>EQUIV PN</u>	<u>DESCRIPTION</u>	<u>AVAILABILITY</u>
ASI-70-1H28			CABLE: 12 PIN EXTENDER FOR RMI-733 A4A1 TO A4TB1	ASI DEALER
ASI-70-1H30			CABLE: MAIN EXTENDER FOR RAI-742	ASI DEALER
ASI-70-1H31			CABLE: POWER SUPPLY EXTENDER FOR RAI-743	ASI DEALER
ASI-70-1J1			RDMI-743 VARIABLE POWER INTERRUPT TESTER FOR STANDARD TEST EQUIPMENT	ASI DEALER
ASI-70-1J2			RDMI-743 VARIABLE POWER INTERRUPT TESTER FOR T1200/T1204	ASI DEALER
ASI-70-1K			RAI-742 ONE-TO-ONE BREAKOUT BOX	ASI DEALER
ASI-70-8A		071-5078-00	CABLE: ASI-708-1 (KTS-157) TO KA594/KFS594	ASI DEALER
ASI-70-8B		071-5045-00	ANTENNA SIMULATOR LOAD (INCLUDES 200-6410-00)	ASI DEALER
ASI-70-8C		071-0123-00	CABLE: ASI-708-1 (KTS-157) TO KTR953 (FOR KCU1051 TESTING)	ASI DEALER
ASI-70-8D		155-J082-01	CABLE: ASI-708-1 (KTS-157) TO KCU1051	ASI DEALER
ASI-71	KA-579A	064-1034-01	TEST POWER SUPPLY FOR KING KFS CONTROLS	ASI DEALER
ASI-72-5A			WMA-701/702X ALIGNMENT PINS (QTY-2)	ASI DEALER
ASI-72-5B	40068		BUBBLE LEVEL FOR ASI-725 LEVELING BASE	ASI DEALER
ASI-72-7A			CABLE: WXI-711 CPU/CONVERTER A7 EXTENDER (50 PIN)	ASI DEALER
ASI-72-7B			CABLE: WXI-711 LVPS A9 EXTENDER (24 PIN)	ASI DEALER
ASI-72-7C			CABLE: WXI-711 VIDEO DEFLECTION A8 EXTENDER (46 PIN)	ASI DEALER
ASI-72-7D			CABLE: WXI-711 FACEPLATE EXTENDER (34 PIN)	ASI DEALER
ASI-72-8A			ALTERNATE FLANGE FOR ASI-728 WEIGHT SIMULATOR	ASI DEALER
ASI-73-8A			CABLE: DF-7708/INDICATOR INTERFACE	ASI DEALER
ASI-73-8B			CABLE: WRT-701X(FLW) RS-232	ASI DEALER
ASI-73-8C			BLOWER TEST LOAD (SIMULATES 642-1245-001 BLOWER / WMT-701X MAN FIG 2006)	ASI DEALER
ASI-73-9A			CABLE: DF-7708/WXI-7X1 INTERFACE (WRT-701X MAN FIG 906)	ASI DEALER
ASI-74-0A		647-2036-001	CABLE: ASI-740 TO EDU-766/776	ASI DEALER
ASI-74-0B		647-8158-001	CABLE: ASI-740 TO RED LABEL POWER SUPPLIES	ASI DEALER
ASI-74-0C		647-4868-001	CABLE: ASI-740 TO BLACK LABEL POWER SUPPLIES	ASI DEALER
ASI-74-2A		2039994-0501	CABLE: ASI-742 (RCT-4A) W1	ASI DEALER
ASI-74-2B		2039995-0501	CABLE: ASI-742 (RCT-4A) W2	ASI DEALER
ASI-74-2C		2039996-0501	CABLE: ASI-742 (RCT-4A) W3	ASI DEALER
ASI-74-2D		2039997-0501	CABLE: ASI-742 (RCT-4A) W4	ASI DEALER
ASI-74-2E		2039998-0501	CABLE: ASI-742 (RCT-4A) W5	ASI DEALER
ASI-74-2F		2039999-0501	CABLE: ASI-742 (RCT-4A) W6	ASI DEALER
ASI-74-2G		2040000-0501	CABLE: ASI-742 (RCT-4A) W7	ASI DEALER
ASI-74-2H			BNC-T 150 OHM LOAD	ASI DEALER
ASI-74-2J			CABLE: SMB/BNC ADAPTER	ASI DEALER
ASI-74-2K		2040904-0501	CABLE: ASI-742 W4 (ASI-74-2D) TO DAA-4B	ASI DEALER
ASI-74-3A		8072626-0502	CABLE: ASI-743 (AIT-4A) TO PPI-1T W1	ASI DEALER
ASI-74-3B		8072628-0502	CABLE: ASI-743 (AIT-4A) TO PPI-1U W2	ASI DEALER
ASI-74-3C		8072625-0502	CABLE: ASI-743 (AIT-4A) TO PPI-4B W3	ASI DEALER
ASI-74-3D		8057438-0501	CABLE: ASI-743 (AIT-4A) TO ITA W4	ASI DEALER
ASI-74-5A		830-3835-001	CABLE: ASI-745-1 TO DLM-900 PWR SUPPLY	ASI DEALER
ASI-74-5B		830-3835-003	CABLE: ASI-745-3 TO SDU-906 PWR SUPPLY	ASI DEALER
ASI-74-5C		830-3835-002	CABLE: ASI-745-2 TO TTR-920 PWR SUPPLY	ASI DEALER
ASI-74-6A		830-1643-001	CABLE: ASI-746 RIBBON	ASI DEALER
ASI-74-6B		830-1644-001	CABLE: ASI-746 RIBBON	ASI DEALER
ASI-74-6C		830-1645-001	CABLE: ASI-746 RIBBON	ASI DEALER
ASI-76-0A		2040030-0501	CABLE: ASI-760 (PPT-4A) TO PPI-4B W1	ASI DEALER
ASI-76-0B		8073780-0001	CABLE: ASI-760 TO CCA-4A	ASI DEALER
ASI-76-0C			POWER SUPPLY LOAD FOR PPI-1T, PPI-1U, PPI-4B (TCAS AND NON-TCAS)	ASI DEALER
ASI-76-2A		830-6309-009	CABLE: ASI-762 NO. 1	ASI DEALER
ASI-76-2A1			CABLE: ASI-762 TO CIU-906 (4 FT LONG)	ASI DEALER
ASI-76-2A2			CABLE: ASI-762 TO CIU-906 (12 FT LONG)	ASI DEALER
ASI-76-2B		830-6309-010	CABLE: ASI-762 NO. 2	ASI DEALER
ASI-76-2C		830-6309-011	CABLE: ASI-762 NO. 3	ASI DEALER
ASI-76-2D		830-6309-012	CABLE: ASI-762 NO. 4	ASI DEALER
ASI-76-2E		830-6309-013	CABLE: ASI-762 NO. 5	ASI DEALER
ASI-76-2F		830-6309-014	CABLE: ASI-762 NO. 6	ASI DEALER
ASI-76-6E			CABLE: RS-232	ASI DEALER
ASI-76-6F			CABLE: DATA LOAD	ASI DEALER
ASI-76-7B			CABLE: CMU-APM TEST-P4	ASI DEALER
ASI-77-0A		2040331-0501	CABLE: ASI-770 (AST-4A) W101	ASI DEALER
ASI-77-0B		2040020-0501	CABLE: ASI-770 (AST-4A) W108	ASI DEALER
ASI-77-1A		2040083-0501	CABLE: ASI-771 (ATT-4A) W1	ASI DEALER
ASI-77-1B		2040082-0501	CABLE: ASI-771 (ATT-4A) W2	ASI DEALER
ASI-77-1C		2040981-0501	CABLE: ASI-771 (ATT-4A) W3	ASI DEALER
ASI-77-1D		2040020-0501	CABLE: ASI-771 (ATT-4A) W4	ASI DEALER
ASI-77-1E		649-0970-000	DAA-4A DUMMY ANTENNA WEIGHT (INCLUDES ASI-77-1E1 AND ASI-77-1E2)	ASI DEALER
ASI-77-1E1		649-0970-001	DAA-4A DUMMY ANTENNA WEIGHT 1 (PART OF ASI-77-1E)	ASI DEALER
ASI-77-1E2		649-0970-002	DAA-4A DUMMY ANTENNA WEIGHT 2 (PART OF ASI-77-1E)	ASI DEALER
ASI-77-1F			DAA-4A AZIMUTH AND ELEVATION GEAR SHAFT LOCKING PLATE (2 REQUIRED)	ASI DEALER

AVAILABILITY:

ASI DEALER: CONTACT ANY ASI DEALER FOR QUOTE
 COLLINS: CONTACT ROCKWELL COLLINS FOR QUOTE
 GABLES: CONTACT GABLES ENGINEERING FOR QUOTE
 TELEPHONICS: CONTACT TELEPHONICS FOR QUOTE

ASI SPECIALIZED TEST EQUIPMENT LIST

AVAILABILITY SUBJECT TO CHANGE WITHOUT NOTICE

ASI MN	EQUIV MN	EQUIV PN	DESCRIPTION	AVAILABILITY
ASI-77-1G			DAA-4A DRIVE UNIT BACKLASH/SYNCHRO XMTR ALIGNMENT FIXTURE	ASI DEALER
ASI-77-2A			CABLE: ASI-772 (KTS-152) TO MAIN UNIT (CABLE 1)	ASI DEALER
ASI-77-2B			CABLE: ASI-772 (KTS-152) TO GYRO (CABLE 2)	ASI DEALER
ASI-77-3A		155-2058-01	CABLE: ASI-773 (KTS-153) TO KI-525/525A TOP PLUG (CABLE 1)	ASI DEALER
ASI-77-3B		155-2058-02	CABLE: ASI-773 (KTS-153) TO KI-525/525A BOTTOM PLUG (CABLE 2)	ASI DEALER
ASI-77-7A		988-9774-001	CABLE: ASI-777 (TE-9210) W1	ASI DEALER
ASI-77-7B		988-9775-001	CABLE: ASI-777 (TE-9210) W2	ASI DEALER
ASI-77-7C		988-9776-001	CABLE: ASI-777 (TE-9210) W3	ASI DEALER
ASI-77-7D		988-9777-001	CABLE: ASI-777 (TE-9210) W4	ASI DEALER
ASI-77-7E		988-9778-001	CABLE: ASI-777 (TE-9210) W5	ASI DEALER
ASI-77-7F		988-9779-001	CABLE: ASI-777 (TE-9210) W6	ASI DEALER
ASI-77-7G		751-7477-001	CABLE: ASI-777 (TE-9210) FIBER OPTIC	ASI DEALER
ASI-77-7H			RF SWITCH BOX FOR HF-9000 (SIMILAR FUNCTION TO ASI-777-91)	ASI DEALER
ASI-77-7J			CABLE: HF-9000 FIBER OPTIC TEST SET UP FIXTURE	ASI DEALER
ASI-77-8A		751-3081-001	EXTENDER CARD: ASI-778 (TE-9400) A1	ASI DEALER
ASI-77-8A1		751-3082-001	EXTENDER CARD: ASI-778 (TE-9400) A3	ASI DEALER
ASI-77-8A2		751-3082-002	EXTENDER CARD: ASI-778 (TE-9400) A3	ASI DEALER
ASI-77-8B		751-3083-001	EXTENDER CARD: ASI-778 (TE-9400) A2	ASI DEALER
ASI-77-8C		751-0998-001	EXTENDER CARD: ASI-778 (TE-9400) A3	ASI DEALER
ASI-77-8D		751-2412-001	CABLE: ASI-778 (TE-9400) W1	ASI DEALER
ASI-77-8E		751-2412-002	CABLE: ASI-778 (TE-9400) W13	ASI DEALER
ASI-77-8F		751-2412-003	CABLE: ASI-778 (TE-9400) W14	ASI DEALER
ASI-77-8G		751-2413-001	CABLE: ASI-778 (TE-9400) W2	ASI DEALER
ASI-77-8H		751-2413-002	CABLE: ASI-778 (TE-9400) W15	ASI DEALER
ASI-77-8J		751-2414-001	CABLE: ASI-778 (TE-9400) W3	ASI DEALER
ASI-77-8K		751-2415-001	CABLE: ASI-778 (TE-9400) W4	ASI DEALER
ASI-77-8L		751-2416-001	CABLE: ASI-778 (TE-9400) W5	ASI DEALER
ASI-77-8M		751-2417-001	CABLE: ASI-778 (TE-9400) W6	ASI DEALER
ASI-77-8N		751-2417-002	CABLE: ASI-778 (TE-9400) W16	ASI DEALER
ASI-77-8P		751-2422-001	CABLE: ASI-778 (TE-9400) W7	ASI DEALER
ASI-77-8Q		751-2423-001	CABLE: ASI-778 (TE-9400) W8	ASI DEALER
ASI-77-8R		751-2424-001	CABLE: ASI-778 (TE-9400) W9	ASI DEALER
ASI-77-8S		751-2425-001	CABLE: ASI-778 (TE-9400) W10	ASI DEALER
ASI-77-8T		751-2426-001	CABLE: ASI-778 (TE-9400) W11	ASI DEALER
ASI-77-8U		751-2427-001	CABLE: ASI-778 (TE-9400) W12	ASI DEALER
ASI-77-8V		751-5126-001	CABLE: ASI-778 (TE-9400) W17	ASI DEALER
ASI-78-01A		4007102-0501	CABLE: ASI-780-1 (P1/P2) TO COMPUTER WITH AMP CONN (TS-810A-02 SB) W1	ASI DEALER
ASI-78-01B		4007114-0501	CABLE: ASI-780-1 (P6) TO ROLL SERVO WITH AMP CONN (TS-810A-02 SB) W2	ASI DEALER
ASI-78-01C		4007114-0502	CABLE: ASI-780-1 (P7) TO PITCH SERVO WITH AMP CONN (TS-810A-02 SB) W3	ASI DEALER
ASI-78-01D		4007114-0503	CABLE: ASI-780-1 (P8) TO TRIM SERVO WITH AMP CONN (TS-810A-02 SB) W4	ASI DEALER
ASI-78-01E		4007107-0501	CABLE: ASI-780-1 (P5) TO PWR SUPPLY WITH AMP CONN (TS-810A-02 SB) W5	ASI DEALER
ASI-78-1E			CABLE: KTS-143 TO KI-229	ASI DEALER
ASI-78-3D			CABLE: ART-2000/2100 40 PIN PCB ASSY EXTENDER	ASI DEALER
ASI-78-3E			WAVEGUIDE PLATE FOR ART-2000/2100	ASI DEALER
ASI-78-3F			CABLE: ASI-783 TO KMD540 (WITH KAC501 CARD)	ASI DEALER
ASI-78-3G			CABLE: ASI-783 TO FLIGHTMAX-740/-750 (WITH 800-00002-010 DIGITAL RDR CARD)	ASI DEALER
ASI-78-5A			CABLE: ASI-785 TO KLN-89/KLN-89A/KLN-94	ASI DEALER
ASI-78-5B			CABLE: ASI-785 TO KLN-90/KLN-90A/KLN-90B	ASI DEALER
ASI-78-5C			CABLE: ASI-785 TO KLN-35A	ASI DEALER
ASI-78-5D			CABLE: ASI-785 TO KTS-143	ASI DEALER
ASI-78-5E			CABLE: KLN TO GPS SIMULATOR	ASI DEALER
ASI-78-5F			CABLE: ASI-785 TO PC SERIAL PORT	ASI DEALER
ASI-78-5G			CABLE: ASI-785 TO KI-229 RMI	ASI DEALER
ASI-78-6A1			CABLE: ASI-786 TO RDS-81/82 RT (RS-811A / RS-181A)	ASI DEALER
ASI-78-6A2			CABLE: ASI-786 TO RDS-81/82 IND (IN-812A / IN-182A)	ASI DEALER
ASI-78-6B1			CABLE: ASI-786 TO RDS-84/86 RT (RS-841A / RS-861A)	ASI DEALER
ASI-78-6B2			CABLE: ASI-786 TO RDS-84/86 IND (IN-842A / IN-862A)	ASI DEALER
ASI-78-6C			CABLE: ASI-786 TO KMD540 (WITH KAC501 CARD)	ASI DEALER
ASI-78-6D			CABLE: ASI-786 TO FLIGHTMAX-740/-750 (WITH 800-00002-010 DIGITAL RDR CARD)	ASI DEALER
ASI-78-9A		522-4855-001	CABLE: W1	ASI DEALER
ASI-78-9B		522-4856-001	CABLE: W2	ASI DEALER
ASI-78-9C		522-4857-001	CABLE: W3	ASI DEALER
ASI-78-9D		522-4939-001	CABLE: W4	ASI DEALER
ASI-79-8A		200-2708-00	CABLE: ASI-798 (KTS-156) TO KR-87 / KI-227 (KTS-156 MAN FIG 6-2)	ASI DEALER
ASI-79-8B		200-2991-00	CABLE: ASI-798 (KTS-156) TO KDF-806 / KI-227 / KFS-586 (KDF-806 MAN FIG 5-1)	ASI DEALER
ASI-79-8C		155-2125-00	CABLE: ASI-798 (KTS-156) 10 PIN JUMPER	ASI DEALER
ASI-79-8D		155-2125-01	CABLE: ASI-798 (KTS-156) 2 PIN JUMPER	ASI DEALER
ASI-79-8E		155-2125-02	CABLE: ASI-798 (KTS-156) 9 PIN JUMPER	ASI DEALER
ASI-79-8F		030-2373-01	ADAPTER: ASI-798 (KTS-156) 7 PIN CONNECTOR	ASI DEALER

AVAILABILITY:

ASI DEALER: CONTACT ANY ASI DEALER FOR QUOTE
 COLLINS: CONTACT ROCKWELL COLLINS FOR QUOTE
 GABLES: CONTACT GABLES ENGINEERING FOR QUOTE
 TELEPHONICS: CONTACT TELEPHONICS FOR QUOTE

ASI SPECIALIZED TEST EQUIPMENT LIST

AVAILABILITY SUBJECT TO CHANGE WITHOUT NOTICE

<u>ASI MN</u>	<u>EQUIV MN</u>	<u>EQUIV PN</u>	<u>DESCRIPTION</u>	<u>AVAILABILITY</u>
ASI-79-9A		8057258-0501	CABLE: ASI-799 (ACT-4A) TO RDR-4 CABLE (MUST BE WIRED TO RDR-4 CABLE)	ASI DEALER
ASI-80-XA		44127-001	CABLE: POWER 115 VAC 60 HZ	ASI DEALER
ASI-80-XB		2040020-0502	CABLE: POWER 115 VAC 400 HZ	ASI DEALER
ASI-80-XC1		2040410-0501	WRAP-AROUND TEST CONNECTOR	ASI DEALER
ASI-80-XC2		2040903-0501	WRAP-AROUND TEST CONNECTOR	ASI DEALER
ASI-80-XD			CABLE: IEEE488	ASI DEALER
ASI-80-XE		2039835-0501	EXTENDER BOARD: TEST SET MODULE	ASI DEALER
ASI-80-XF		2040179-0501	EXTENDER CABLE: TEST SET MODULE	ASI DEALER
ASI-80-XG		2040692-0501	POWER CABLE, 28VDC	ASI DEALER
ASI-80-1			CABLE: THINLINE 160 PIN EXTENDER/BREAKOUT BOX FOR EFIS-85/86 AND APS-85	ASI DEALER
ASI-80-2			CABLE: THINLINE 160 PIN EXTENDER CABLE FOR EFIS-85/86 AND APS-85	ASI DEALER
ASI-80-1A		2040065-0501	CABLE, ASI-801 TO DMA-37A (W101)	ASI DEALER
ASI-80-2A		2040070-0501	CABLE: ASI-802 (ALT-52A) TO ALA-52A (W101)	ASI DEALER
ASI-80-3A		2040282-0504	CABLE: ASI-803 (RTT-44A) TO RTA-44A AND RTA-83B (W101)	ASI DEALER
ASI-80-3B		747-0446-001	CABLE: ASI-803 (RTT-44A) TO RTA-83A	ASI DEALER
ASI-80-4A		2040300-0501	CABLE: ASI-804-1 (DFT-75A) TO DFA-75A	ASI DEALER
ASI-80-41A			CABLE, DFA-75A TO DIT-MCO HI-POT	ASI DEALER
ASI-80-5A		2040085-0501	CABLE: ASI-805-X (RNT-30A) TO RIA-35A AND RIA-35B (W101)	ASI DEALER
ASI-80-5B		2041779-0501	CABLE: ASI-805-X (RNT-30A) TO RVA-36A (W102)	ASI DEALER
ASI-81-01A		55-0215-15	CABLE: ASI-810-1 TO DF-431B / AT-434A	ASI DEALER
ASI-81-01B			SWITCHBOX: AT-434A	ASI DEALER
ASI-81-01C		55-0215-05	CABLE: ASI-810-1 TO DF-431A / AT-434A	ASI DEALER
ASI-81-01D			ISOLATION TRANSFORMER	ASI DEALER
ASI-81-01E		005-02101-0070	TEST PROM FOR DF-431B	ASI DEALER
ASI-81-02A		55-0215-11	CABLE: ASI-810-2 TO VC-401B	ASI DEALER
ASI-81-02B		55-0215-12	CABLE: ASI-810-2 TO VN-411B / KI-227	ASI DEALER
ASI-81-02C		55-0215-06	HSI SUBSTITUTION PLUG	ASI DEALER
ASI-81-02D			CABLE: ASI-810-2 TO KI-206	ASI DEALER
ASI-81-02E1			HIGH IMPEDANCE DETECTOR PROBE FOR VC-401()	ASI DEALER
ASI-81-02E2			HIGH IMPEDANCE DETECTOR PROBE FOR VN411()	ASI DEALER
ASI-81-02E3			LINEAR DETECTOR FOR VC-401()	ASI DEALER
ASI-81-02F		55-0215-01	CABLE: ASI-810-2 TO VC-401A	ASI DEALER
ASI-81-02G		55-0215-02	CABLE: ASI-810-2 TO VN-411A / KI-227	ASI DEALER
ASI-81-03A		55-0215-13	CABLE: ASI-801-3 TO TR-421B	ASI DEALER
ASI-81-03B		55-0215-14	CABLE: ASI-801-3 TO DM-441B	ASI DEALER
ASI-81-03C		55-0215-03	CABLE: ASI-801-3 TO TR-421A	ASI DEALER
ASI-81-03D		55-0215-04	CABLE: ASI-801-3 TO DM-441A	ASI DEALER
ASI-81-22A			CABLE: RS-422 INPUT	ASI DEALER
ASI-81-22B			CABLE: RS-485 INPUT	ASI DEALER
ASI-81-22C			CABLE: ARINC 429 INPUT	ASI DEALER
ASI-83C	HTS-83C	2900-00083-003	AUDIO WATT METER (2mW to 200W)	ASI DEALER
ASI-84-1A		628-8847-001	CABLE: ASI-CTS-841 TO DSP	ASI DEALER
ASI-84-1B		628-8847-002	CABLE: ASI-CTS-841 TO POWER SUPPLY	ASI DEALER
ASI-84-1C		628-8847-003	CABLE: ASI-CTS-841 RF CABLE	ASI DEALER
ASI-84-1D		628-8847-004	CABLE: ASI-CTS-841 TO RF BASE	ASI DEALER
ASI-84-1E		628-8847-005	CABLE: ASI-CTS-841 TO INDICATOR	ASI DEALER
ASI-84-1F		628-8847-006	CABLE: ASI-CTS-841 TO TERMINAL	ASI DEALER
ASI-84-1G		628-8847-007	CABLE: ASI-CTS-841 TO MODULATOR	ASI DEALER
ASI-84-1H		628-8847-008	CABLE: ASI-CTS-841 TO DIGITAL ATTITUDE SOURCE	ASI DEALER
ASI-84-1J		628-8847-009	CABLE: ASI-CTS-841 TO WXP-850	ASI DEALER
ASI-84-1K		628-8847-010	CABLE: ASI-CTS-841 TO IMPATT	ASI DEALER
ASI-84-1L		628-8847-011	CABLE: ASI-CTS-841 RF CABLE	ASI DEALER
ASI-84-1M		628-8847-012	CABLE: ASI-CTS-841 TRF BASE	ASI DEALER
ASI-84-1N		628-8847-013	CABLE: ASI-CTS-841 RF CABLE	ASI DEALER
ASI-84-1P		628-8847-014	CABLE: ASI-CTS-841 TO RF BASE	ASI DEALER
ASI-84-1Q		628-8847-015	CABLE: ASI-CTS-841 TO POWER SUPPLY	ASI DEALER
ASI-84-1R		628-8847-016	CABLE: ASI-CTS-841 TO ALTERNATE INDICATOR (FLIGHTMAX 950)	ASI DEALER
ASI-84-1S		628-8847-017	CABLE: ETC	ASI DEALER
ASI-94-0A		628-8752-001	CABLE: ASI-CTS-940 TO TDR-94/94D	ASI DEALER
ASI-94-0A1		628-8752-001	CABLE: ASI-CTS-940 TO TDR-94/94D (9 FEET LONG)	ASI DEALER
ASI-94-0B		628-8753-001 (A)	CABLE: ASI-CTS-940 TO ARINC SMART CARD	ASI DEALER
ASI-94-0B1		628-8753-001 (B)	CABLE: ASI-CTS-940 TO OMNIBUS BOX	ASI DEALER
ASI-94-0C		628-8754-001	CABLE: ASI-CTS-940 TO CONTEC I/O CARD	ASI DEALER
ASI-94-0F			CABLE: ASI-94-0C TO I/O CARD (PREFERRED METHOD ONLY)	ASI DEALER
ASI-94-0G			CABLE: ASI-94-0B TO ARINC/CSDB CARDS (PREFERRED METHOD ONLY)	ASI DEALER
ASI-94-1A			CABLE: ASI-CTS-941/AR TO COLLINS RTU-870A	ASI DEALER
ASI-94-1B			CABLE: ASI-CTS-941/AR TO COLLINS CTL-92/92A	ASI DEALER
ASI-94-1C			CABLE: ASI-CTS-941/AR TO GABLES 816	ASI DEALER
ASI-94-1D			CABLE: ASI-CTS-941/AR TO COLLINS TDR-94/94D	ASI DEALER

AVAILABILITY:

ASI DEALER: CONTACT ANY ASI DEALER FOR QUOTE
 COLLINS: CONTACT ROCKWELL COLLINS FOR QUOTE
 GABLES: CONTACT GABLES ENGINEERING FOR QUOTE
 TELEPHONICS: CONTACT TELEPHONICS FOR QUOTE

ASI SPECIALIZED TEST EQUIPMENT LIST

AVAILABILITY SUBJECT TO CHANGE WITHOUT NOTICE

<u>ASI MN</u>	<u>EQUIV MN</u>	<u>EQUIV PN</u>	<u>DESCRIPTION</u>	<u>AVAILABILITY</u>
ASI-94-1E			CABLE: ATC-601 TO COLLINS TDR-94/94D ANTENNA	ASI DEALER
ASI-94-1F			CABLE: ASI-CTS-941/AR TO COLLINS TDR-94/94D WITH DATA LINK	ASI DEALER
ASI-94-1G			TEST FIXTURE: TDR-94/94D IF RECEIVER/LVPS/HVPS	ASI DEALER
ASI-94-1H			TEST FIXTURE: TDR-94/94D MODULATOR MODULE A3	ASI DEALER
ASI-94-1I			CABLE: RFPA TO IF RECEIVER RF EXTENDER CABLE	ASI DEALER
ASI-94-1J			CABLE: ASI-CTS-941AR TO COLLINS TTR-920G CONTROL	ASI DEALER
ASI-94-1K			CABLE: ATC-1400A AND S-1403C TO TDR-94D ANTENNA	ASI DEALER
ASI-94-1L			TEST FIXTURE: TDR-94/94D SYNTHESIZER MODULE A4	ASI DEALER
ASI-94-1M			HIGH CURRENT LOAD: MODULATOR PEAK CURRENT DETECTOR	ASI DEALER
ASI-94-1N			SYNTHESIZER ALIGNMENT TOOLS (SET OF 4)	ASI DEALER
ASI-94-1O			TEST PROBE HOLDER AND CLIP RAIL ASSY	ASI DEALER
ASI-94-1P			RF PROBE FOR PWR METER, SPECTRUM ANALYZER, OR SCOPE	ASI DEALER
ASI-94-1Q			ALIGNMENT COVER: IF RECEIVER MODULE COVER A	ASI DEALER
ASI-94-1R			ALIGNMENT COVER: IF RECEIVER MODULE COVER B	ASI DEALER
ASI-94-1S			ALIGNMENT COVER: TRANSMITTER AND RECEIVER FRONT END	ASI DEALER
ASI-94-1T			CABLE: ASI-CTS-941AR TO BENDIX MST-67A TRANSPONDER	ASI DEALER
ASI-94-1T			CABLE: ADAPTER FOR TDR-94D (-004)	ASI DEALER
ASI-94-2A			CABLE: TEST STATION WITH HIGH LEVEL SWITCH BOX	COLLINS
ASI-94-3A			CABLE: ASI-CTS-943 TO UUT J1	COLLINS
ASI-94-3B			CABLE: ASI-CTS-943 TO UUT J2	COLLINS
ASI-94-3C			CABLE: SMART CARD TO MASS XFER SWITCH	COLLINS
ASI-94-3D			CABLE: ASI-CTS-943 POWER CABEL	COLLINS
ASI-94-5A			CABLE: SMART CARD/A453	COLLINS
ASI-94-5B			CABLE: UUT J1	COLLINS
ASI-94-5C			CABLE: MASS XFER	COLLINS
ASI-94-5D			CABLE: 28 VDC POWER	COLLINS
ASI-94-5E			CABLE: 115 VAC POWER	COLLINS
ASI-95-4A			CABLE: ASI-CTS-954 TO TDR-94/94D A3-J8	COLLINS
ASI-95-4B			CABLE: ASI-CTS-954 TO TDR-94/94D A3-J24	COLLINS
ASI-95-4C			CABLE: ASI-CTS-954 TO TDR-94/94D A3-J5	COLLINS
ASI-95-4D			CABLE: ASI-CTS-954 POWER INPUT	COLLINS
ASI-96-9A			CABLE: CTS-88 TO FDU-70 (INCLUDED WITH ASI-CTS-969)	ASI DEALER
ASI-96-9B			CABLE: CTS-88 TO ASI-CTS-969 (INCLUDED WITH ASI-CTS-969)	ASI DEALER
ASI-96-9C			CABLE: 323A-2G BREAKOUT CABLE (INCLUDED WITH ASI-CTS-969)	ASI DEALER
ASI-96-9D			CABLE: ASI-CTS-969 TO VXI	COLLINS
ASI-97-6A		932500-400-W1	CABLE: ASI-CTS-976 (W1)	COLLINS
ASI-97-6B		932500-400-W4	CABLE: ASI-CTS-976 (W4)	COLLINS
ASI-97-6C		932500-400-W16	CABLE: ASI-CTS-976 (W16)	COLLINS
ASI-97-6D		932500-400-W31	CABLE: ASI-CTS-976 (W31)	COLLINS
ASI-97-6E			CABLE: ATP	COLLINS
ASI-97-9A			CABLE: RIU-4000 ESS UUT	COLLINS
ASI-97-9B			CABLE: RIU-4000 ESS PWR SPLY	COLLINS
ASI-97-9C			CABLE: RIU-4000 ESS CYTECH I/O	COLLINS
ASI-97-9D			CABLE: RIU-4000 ESS T/L PWR SPLY	COLLINS
ASI-98-1A			CABLE: ASI-CTS-981 TO UUT	COLLINS
ASI-98-1B			CABLE: ASI-CTS-981 TO POWER SUPPLY	COLLINS
ASI-98-1C			CABLE: ASI-CTS-981 TO CYTEC I/O	COLLINS
ASI-101D			DIGITAL SIGNAL GENERATOR	ASI DEALER
ASI-101-00908		101-00908	CABLE: TT1000A TO CF6/CF6-50	ASI DEALER
ASI-106-1		EMB-120	FCEU EXTENDER CABLE	ASI DEALER
ASI-110-1	HTS-110	2900-00110-000	SOLID STATE DIGITAL SYNCHRO (ACCURACY +/- 0.067 DEGREES / 4 MIN)	ASI DEALER
ASI-110-2	HTS-110	2900-00110-001	SOLID STATE DIGITAL SYNCHRO (ACCURACY +/- 0.033 DEGREES / 2 MIN)	ASI DEALER
ASI-110-344		110-344	CABLE: TEST SET J4 TO INTERFACE P1 (W4)	ASI DEALER
ASI-100-0440-201		100-0440-201	CABLE: ARA-02 TO 860F-1/-4	ASI DEALER
ASI-100-0440-202		100-0440-202	CABLE: ARA-02 TO 339H-1/-2	ASI DEALER
ASI-100-0440-203		100-0440-203	CABLE: ARA-02 TO 860F-1/-4 J9	ASI DEALER
ASI-110-0440-101	AY969-00298-002	110-0440-101	CABLE: DRA-707 TO LRA-700 (TRIPLEX CABLE)	ASI DEALER
ASI-110-0440-102		110-0440-102	CABLE: DRA-707 TO AIRBUS A310 WITH LRA-700/900	ASI DEALER
ASI-110-0440-103		110-0440-103	CABLE: DRA-707 EXTENSION (50')	ASI DEALER
ASI-110-0440-105		110-0440-105	CABLE: DRA-707 TO AIRBUS A310 WITH AHV-530	ASI DEALER
ASI-110-0440-106		110-0440-106	CABLE: DRA-707 TO AHV-530A (TRIPLEX CABLE)	ASI DEALER
ASI-110-0440-202	AY969-00313	110-0440-202	CABLE: ARA-552 TO 860F-1/-4 (10')	ASI DEALER
ASI-110-0440-203	AY969-00319	110-0440-203	CABLE: ARA-552 TO ALA-51A (10')	ASI DEALER
ASI-110-0440-204	AY969-00320	110-0440-204	CABLE: ARA-552 TO ARINC-552	ASI DEALER
ASI-110-0440-205	AY969-00314	110-0440-205	CABLE: ARA-552 TO ALT-50A / ALT-55B	ASI DEALER
ASI-110-0440-206-1	AY969-00315-001	110-0440-206 (1)	CABLE: ARA-552 TO ALA-52 (1)	ASI DEALER
ASI-110-0440-206-2	AY969-00315-002	110-0440-206 (2)	CABLE: ARA-552 TO ALA-52 (2)	ASI DEALER
ASI-110-0440-206-3	AY969-00315-003	110-0440-206 (3)	CABLE: ARA-552 TO ALA-52 (3)	ASI DEALER
ASI-110-0440-207		110-0440-207	CABLE: ARA-552 TO HG7502BC05	ASI DEALER

AVAILABILITY:

ASI DEALER: CONTACT ANY ASI DEALER FOR QUOTE
 COLLINS: CONTACT ROCKWELL COLLINS FOR QUOTE
 GABLES: CONTACT GABLES ENGINEERING FOR QUOTE
 TELEPHONICS: CONTACT TELEPHONICS FOR QUOTE

ASI SPECIALIZED TEST EQUIPMENT LIST

AVAILABILITY SUBJECT TO CHANGE WITHOUT NOTICE

<u>ASI MN</u>	<u>EQUIV MN</u>	<u>EQUIV PN</u>	<u>DESCRIPTION</u>	<u>AVAILABILITY</u>
ASI-110-0446-201		110-0446-201	CABLE: ARA-552/DRA-707 INTERFACE (80')	ASI DEALER
ASI-110-0446-202		110-0446-202	CABLE: ARA-552 TO HHC-552 INTERFACE (80')	ASI DEALER
ASI-110-0446-203		110-0446-203	CABLE: ARA-552/DRA-707 INTERFACE (120')	ASI DEALER
ASI-110-0446-204		110-0446-204	CABLE: ARA-552 TO HHC-552 INTERFACE (120')	ASI DEALER
ASI-115	HTS-1101		INDICATOR TEST PANEL FOR C-6()	ASI DEALER
ASI-116			GPS TEST PANEL FOR KLX-135	ASI DEALER
ASI-119			MANUAL TEST PANEL FOR VIR-30/31/32/33 (SUGGESTED REPLACEMENT: ASI-127-1)	ASI DEALER
ASI-120			BRG TEST PANEL FOR TCN-40 (DME-40A / BRG-40)	ASI DEALER
ASI-121			BIA TEST PANEL FOR BIA-32	ASI DEALER
ASI-122			DDA TEST PANEL FOR DDA-42	ASI DEALER
ASI-123			BDI TEST PANEL FOR BDI-36 (DME SECTION)	ASI DEALER
ASI-124			CAD TEST PANEL FOR CAD-870G	ASI DEALER
ASI-125			COM TEST PANEL FOR VHF-21(), VHF-22(), VHF-422()	ASI DEALER
ASI-125-1			COM TEST PANEL FOR VHF-22() MANUAL TESTING (REQ ASI-12-51A OR 51B CABLE)	ASI DEALER
ASI-126			CONTROL HEAD TEST PANEL FOR CTL-X2/X2A, CTL-23	ASI DEALER
ASI-127			NAV TEST PANEL FOR VIR-30/-31 (SUGGESTED REPLACEMENT: ASI-127-1)	ASI DEALER
ASI-127-1			MANUAL TEST PANEL FOR VIR-30/-31/-32/-33 (NON-COMPUTER TESTING)	ASI DEALER
ASI-128			COMPUTER ASSISTED TEST PANEL FOR VIR-32/-33/-432/-433	ASI DEALER
ASI-129			CONTROL ADAPTER TEST PANEL FOR CAD-31, CAD-62, CAD-92	ASI DEALER
ASI-130			TRANSPONDER TEST PANEL FOR TDR-90	ASI DEALER
ASI-131			HF CONTROL HEAD TEST PANEL FOR CTL-230	ASI DEALER
ASI-132			RAC/CAD TEST PANEL FOR RAC-870, CAD-870	ASI DEALER
ASI-133			RTU TEST PANEL FOR RTU-870A, RTU-870T	ASI DEALER
ASI-134			DME TEST PANEL FOR DME-42/-442 (INCLUDES INTERNAL DME SIM BOARD)	ASI DEALER
ASI-135			ADF TEST PANEL FOR ADF-462 (REQUIRES ASI-185 OR 970G-1)	ASI DEALER
ASI-136			VHF TEST PANEL FOR VHF-4000	ASI DEALER
ASI-137			VHF TEST PANEL FOR NAV-4000	ASI DEALER
ASI-138			VHF TEST PANEL FOR DME-4000	ASI DEALER
ASI-140			HEADING SELECTOR SYNCHRO	ASI DEALER
ASI-141			HEADING CONTROL TRANSFORMER	ASI DEALER
ASI-142-1	477L-1	522-1147-004	COMPASS SIMULATOR	ASI DEALER
ASI-142-2			COMPASS SIMULATOR (19 INCH RACK MOUNT VERSION)	ASI DEALER
ASI-142-3			VOR SIN-COS GENERATOR	ASI DEALER
ASI-143-1	477K-1	522-1146-004	GYRO SIMULATOR	ASI DEALER
ASI-143-2			GYRO SIMULATOR (19 INCH RACK VERSION)	ASI DEALER
ASI-145		023-0127-00	TO-FROM METER (500-0-500 uA)	ASI DEALER
ASI-146		023-0114-00	FLAG METER (0-500 uA)	ASI DEALER
ASI-147		023-0113-00	DEVIATION METER (100-0-100 uA)	ASI DEALER
ASI-150			UNIVERSAL TRACK SELECTOR	ASI DEALER
ASI-150-1		050-1571-01	UNIVERSAL TRACK SELECTOR WITH (30HZ / 400 HZ SWITCH PER KING SM105)	ASI DEALER
ASI-151			AIR DATA CONTROL TEST SET FOR COLLINS 590A-3H/3J/3J1/3K/3K1	ASI DEALER
ASI-152-1	RDT-1F	2038139-0501	BENDIX RDR-1F R/T TEST PANEL	ASI DEALER
ASI-152-2	RDT-1FB	2041351-0102	BENDIX RDR-1FB R/T TEST PANEL	ASI DEALER
ASI-153-1	ATT-1F	2038070-0501	BENDIX ANT-1T TEST PANEL	ASI DEALER
ASI-153-2	ATT-1FB	2038270-0502	BENDIX ANT-1TB TEST PANEL	ASI DEALER
ASI-153-3	ATT-1FB	2038270-0503	BENDIX ANT-1TB TEST PANEL WITH SECTOR SCAN TEST ADAPTER (ASI-153-4)	ASI DEALER
ASI-153-4	ANT-1FBM	8056275-0501	SECTOR SCAN ANTENNA TEST ADAPTER (REQUIRES USER SUPPLIED CON-1TB(M)	ASI DEALER
ASI-154-1	RCT-1F	2038326-0501	BENDIX RDR-1F SYSTEM TEST PANEL	ASI DEALER
ASI-154-2	RCT-1FB	2041349-0102	BENDIX RDR-1FB / RDR-1FB(M) SYSTEM TEST PANEL	ASI DEALER
ASI-155		7010569-901	UNIVERSAL DIGITAL INTERFACE (UDI) FOR PRIMUS DIGITAL INDICATORS	ASI DEALER
ASI-156		685-6581-001	AHRS MONITOR INTERFACE PANEL FOR COLLINS AHC-85	ASI DEALER
ASI-158		637-7656-001	UNIVERSAL HIGH POT TESTER (REQUIRES USER SUPPLIED FLUKE 8000A OR EQUIV)	ASI DEALER
ASI-158-1		637-7656-100	UNIVERSAL HIGH POT TESTER (REQUIRES USER SUPPLIED FLUKE 8000A OR EQUIV)	ASI DEALER
ASI-159			ARC-159 MODULE TESTER (BUILT TO LSI PRINTS)	ASI DEALER
ASI-160			UNIVERSAL HEADING & TRACK SELECTOR (REQ 36105 OR EQU RMI KDA-697)	ASI DEALER
ASI-160B			UNIVERSAL HEADING & TRACK SELECTOR (REQ 332C-10 OR EQU RMI)	ASI DEALER
ASI-160C			UNIVERSAL HEADING & TRACK SELECTOR WITH METERS (REQ 332C-10 OR EQU)	ASI DEALER
ASI-161	479V-3	522-1339-000	PRECISION TRACK SELECTOR	ASI DEALER
ASI-162			RADIO SET CONTROL TEST PANEL (714E-1, 714E-2(), 714E-3(), 714E-6()	ASI DEALER
ASI-163			PRIMUS-90 RADAR TEST SET	ASI DEALER
ASI-164			RADIO ALTIMETER INDICATOR TEST SET: COLLINS 339H-X SERIES INDICATORS	ASI DEALER
ASI-165	CSS-10	622-5330-001	UNIVERSAL HEADING SELECTOR	ASI DEALER
ASI-166	479X-2	522-0167-001	RESOLVER ZEROING PANEL	ASI DEALER
ASI-166A			TEST PANEL FOR ASI-161 / 479V-3 / 79V-3	ASI DEALER
ASI-167	978F-2S	522-3498-000	SYNCHRO SIMULATOR	ASI DEALER
ASI-168			COLLINS 332D-11() GYRO TEST SET	ASI DEALER
ASI-168-1	ASI-168A		NOISE TEST FIXTURE FOR 332D-11	ASI DEALER
ASI-169	RST-1A	2064746-0501	BENDIX RDR-1E STABILIZATION RAMP TEST SET	ASI DEALER
ASI-169-2	RST-4A	2041797-0401	RTA-4A RADAR RAMP TEST SET	ASI DEALER

AVAILABILITY:

ASI DEALER: CONTACT ANY ASI DEALER FOR QUOTE
 COLLINS: CONTACT ROCKWELL COLLINS FOR QUOTE
 GABLES: CONTACT GABLES ENGINEERING FOR QUOTE
 TELEPHONICS: CONTACT TELEPHONICS FOR QUOTE

ASI SPECIALIZED TEST EQUIPMENT LIST

AVAILABILITY SUBJECT TO CHANGE WITHOUT NOTICE

<u>ASI MN</u>	<u>EQUIV MN</u>	<u>EQUIV PN</u>	<u>DESCRIPTION</u>	<u>AVAILABILITY</u>
ASI-170	RFT-1A	2038142-0501	BENDIX RDR-1F RADAR RAMP RADAR TEST SET	ASI DEALER
ASI-171	RDT-1A	2037736-0501	BENDIX RDR-1E RADAR TEST PANEL	ASI DEALER
ASI-172	RDT-1B	2037737-0501	BENDIX ANT-1() RADAR ANTENNA TEST SET	ASI DEALER
ASI-173	PPT-1A	2037738-0501	BENDIX PPI-1() RADAR INDICATOR TEST SET	ASI DEALER
ASI-174	PPT-1B	2038141-0501	BENDIX PPI-1() RADAR INDICATOR TEST SET	ASI DEALER
ASI-175	AMT-51A	2037028-5103	RADIO ALTIMETER RAMP TEST SET (MOD 2)	ASI DEALER
ASI-175-2	AMT-52A	2041595-5201	PORTABLE ALTIMETER TEST SET	ASI DEALER
ASI-176A			ARINC 568 DME IND TEST SET (REPLACED BY ASI-176-1)	ASI DEALER
ASI-176BR			ARINC 568 DME IND TEST SET W/MASTER IND (REPLACED BY ASI-176-1)	ASI DEALER
ASI-176-1			ARINC 568 DME IND TEST SET.	ASI DEALER
ASI-177-1	RNT-26A	2064139-0501	VHF-NAV TEST SET FOR BENDIX RNA-26C / RNA-34A	ASI DEALER
ASI-177-2	RNT-260A	4000951-6002	TEST PANEL FOR AN/ARN-123 (SPECIAL USCG VERSION)	ASI DEALER
ASI-177-2-04	RNT-260A	4000951-6004	TEST PANEL FOR AN/ARN-127 / AN/ARN-147 / RN-260A	ASI DEALER
ASI-178	477Q-1A	522-3330-000	COLLINS 331A-3F/3G/6D TEST SET (ALSO REPLACES 477Q-1)	ASI DEALER
ASI-178-1	477Q-1	522-1151-000	COLLINS 331A-3F/3G TEST SET (REPLACED BY ASI-178 / 477Q-1A)	ASI DEALER
ASI-179	476E-7	522-2078-000	COLLINS 332E-4 TEST SET (REQUIRES ASI-17-9A CABLE)	ASI DEALER
ASI-180			328A-3G TEST PANEL	ASI DEALER
ASI-181	975D-1	787-6842-001	COLLINS DME TEST SET (REPLACED BY ASI-182)	ASI DEALER
ASI-182	975D-2	622-3582-001	COLLINS DME TEST SET	ASI DEALER
ASI-183-1	971F-1	622-2013-001	AUTO PILOT TEST SET (12 CABLES INCLUDED WITH TEST SET)	ASI DEALER
ASI-183-2	971F-1	622-2013-002	AUTO PILOT TEST SET (CABLES NOT INCLUDED)	ASI DEALER
ASI-184	477V-3	792-6209-001	FAULT ISOLATION PANEL	ASI DEALER
ASI-185	970G-1	622-2854-001	ADF-60 TEST SET	ASI DEALER
ASI-186	970W-1	622-3099-001	ADF ANTENNA SIMULATOR (SEE ASI-61W FOR EQUIVALENT)	ASI DEALER
ASI-187	970E-1	622-2914-001	RMI TEST SET	ASI DEALER
ASI-187-PS1			POWER SUPPLY FOR ASI-187/970E-1	ASI DEALER
ASI-188-1		635-3127-001	RADAR TEST PANEL FOR WXR-150/200/220/250/270/300/350	ASI DEALER
ASI-188-2			ANTENNA CALIBRATION / TEST FIXTURE FOR ANT-310/312/318	ASI DEALER
ASI-188-3			COLLINS RADAR SYSTEMS FLIGHT LINE TEST FIXTURE	ASI DEALER
ASI-188-4			IND-270A TEST PANEL (WXR-270A MAN FIG 2-31 THRU 2-35)	ASI DEALER
ASI-188-7			WXP-85 BREAKOUT BOX	ASI DEALER
ASI-189	960M-3	622-2741-001	THIS ITEM HAS BEEN RE-NUMBERED TO ASI-212-3 (SEE ASI-212-3 FOR LIST PRICE)	ASI DEALER
ASI-190			UNIVERSAL TRACK SELECTOR	ASI DEALER
ASI-190B			UNIVERSAL TRACK SELECTOR WITH METERS	ASI DEALER
ASI-191	978F-1D	522-3424-000	INSTRUMENT TEST SET (COMES WITH GENERAL OVERLAY ONLY)	ASI DEALER
ASI-191-001		757-0544-001	ASI-191 (978F-1D) OVERLAY FOR TESTING 329B-7	ASI DEALER
ASI-191-002		757-0544-002	ASI-191 (978F-1D) OVERLAY FOR TESTING 331A-7	ASI DEALER
ASI-191-003		757-0544-003	ASI-191 (978F-1D) OVERLAY FOR TESTING 329B-7A	ASI DEALER
ASI-191-004		757-0544-004	ASI-191 (978F-1D) OVERLAY FOR TESTING 329B-7C	ASI DEALER
ASI-191-005		757-0544-005	ASI-191 (978F-1D) OVERLAY FOR TESTING 329B-6D	ASI DEALER
ASI-191-006		757-0544-006	ASI-191 (978F-1D) OVERLAY FOR TESTING 331A-6A	ASI DEALER
ASI-191-007		757-0544-007	ASI-191 (978F-1D) OVERLAY FOR TESTING 331A-6D	ASI DEALER
ASI-191-008		757-0544-008	ASI-191 (978F-1D) OVERLAY FOR TESTING 331A-7A	ASI DEALER
ASI-191-009		757-0544-009	ASI-191 (978F-1D) OVERLAY FOR TESTING 329B-7F	ASI DEALER
ASI-191-010		757-0544-010	ASI-191 (978F-1D) OVERLAY FOR TESTING 329B-7F-1	ASI DEALER
ASI-191-011		757-0544-011	ASI-191 (978F-1D) OVERLAY FOR TESTING 329B-7G	ASI DEALER
ASI-191-012		757-0544-012	ASI-191 (978F-1D) OVERLAY FOR TESTING 331A-6E	ASI DEALER
ASI-191-013		757-0544-013	ASI-191 (978F-1D) OVERLAY FOR TESTING 329B-7J	ASI DEALER
ASI-191-014		757-0544-014	ASI-191 (978F-1D) OVERLAY FOR TESTING 329B-7K	ASI DEALER
ASI-191-015		757-0544-015	ASI-191 (978F-1D) OVERLAY FOR TESTING 329B-8C	ASI DEALER
ASI-191-016		757-0544-016	ASI-191 (978F-1D) OVERLAY FOR TESTING 331A-6K	ASI DEALER
ASI-191-017		757-0544-017	ASI-191 (978F-1D) OVERLAY FOR TESTING 329B-6E	ASI DEALER
ASI-191-018		757-0544-018	ASI-191 (978F-1D) OVERLAY FOR TESTING 329B-8A	ASI DEALER
ASI-191-019		757-0544-019	ASI-191 (978F-1D) OVERLAY FOR TESTING 329B-8B	ASI DEALER
ASI-191-020		757-0544-020	ASI-191 (978F-1D) OVERLAY FOR TESTING 329B-8F	ASI DEALER
ASI-191-021		757-0544-021	ASI-191 (978F-1D) OVERLAY FOR TESTING 329B-7M	ASI DEALER
ASI-191-022		757-0544-022	ASI-191 (978F-1D) OVERLAY FOR TESTING 329B-8G	ASI DEALER
ASI-191-023		757-0544-023	ASI-191 (978F-1D) OVERLAY FOR TESTING 329B-8N	ASI DEALER
ASI-191-024		761-5230-006	ASI-191 (978F-1D) OVERLAY FOR TESTING 331A-3G/6P/HSI-70	ASI DEALER
ASI-191-025			ASI-191 (978F-1D) OVERLAY FOR ADI-84/329B-7R	ASI DEALER
ASI-191-1			ADAPTER PANEL: 978F-1D TO ADI-84 / 329B-7R (REQUIRES ASI-19-11A, ASI-19-11B)	ASI DEALER
ASI-191-2			BREAKOUT BOX: ADI-84 / 329B-7R	ASI DEALER
ASI-191-3			ADAPTER BOX: 978F-1D TO HSI-70()	ASI DEALER
ASI-191-4		647-4762-001	BREAKOUT BOX: 331A-3G	ASI DEALER
ASI-191-5			BREAKOUT BOX: 331A-6P/6R	ASI DEALER
ASI-192	477U-2	522-2710-000	ADF ANTENNA SIMULATOR (WITH 3 CABLES)	ASI DEALER
ASI-193	477V-2	522-2711-002	ADF-TEST SET (WITH 3 CABLES)	ASI DEALER
ASI-194			860F-1/4 RADIO ALTIMETER TEST PANEL	ASI DEALER
ASI-195			TEST SET FOR JET PS-823() EMERGENCY POWER SUPPLY (WITH 1 CABLE)	ASI DEALER

AVAILABILITY:

ASI DEALER: CONTACT ANY ASI DEALER FOR QUOTE
 COLLINS: CONTACT ROCKWELL COLLINS FOR QUOTE
 GABLES: CONTACT GABLES ENGINEERING FOR QUOTE
 TELEPHONICS: CONTACT TELEPHONICS FOR QUOTE

ASI SPECIALIZED TEST EQUIPMENT LIST

AVAILABILITY SUBJECT TO CHANGE WITHOUT NOTICE

ASI MN	EQUIV MN	EQUIV PN	DESCRIPTION	AVAILABILITY
ASI-196			TEST SET FOR JET PS-835() EMERGENCY POWER SUPPLY (WITH 2 CABLES)	ASI DEALER
ASI-196-1	JT-138A	570-7996-01	TEST SET FOR PS-850() / PS-855()	ASI DEALER
ASI-196-2			CAPACITY TEST SET FOR PS-834() (WITH 1 CABLE) (PS-834 MAN FIG 102)	ASI DEALER
ASI-197	PPT-1CG	2041323-0101	PPI-1U TEST PATTERN GENERATOR	ASI DEALER
ASI-198		2039597-0501	PP1-1U RADAR TEST ADAPTER	ASI DEALER
ASI-199	ALT-51A	2037120-0501	ALA-51A/INA-51A TEST PANEL WITH DELAY LINE	ASI DEALER
ASI-199-1			ALA-51A/INA-51A TEST PANEL WITHOUT DELAY LINE	ASI DEALER
ASI-199-3		2068256-0701	650 nS DELAY LINE (P/O ASI-199)	ASI DEALER
ASI-199-4			ALA-51A TRANSMITTER TEST MODULATOR	ASI DEALER
ASI-199-5			ALA-51A TRANSMITTER TEST FIXTURE	ASI DEALER
ASI-200-1			ASI-2000 PLUG IN FOR CTL-22, 32, 62, 92	ASI DEALER
ASI-200-2A			ASI-2000 PLUG IN FOR VIR-32 (WITH HEADING SYNCHRO ONLY)	ASI DEALER
ASI-200-2B			ASI-2000 PLUG IN FOR VIR-32 (WITH HDG SYNC,TO-FR MTR,OBS,RESOLVER)	ASI DEALER
ASI-200-2C			ASI-2000 PLUG IN FOR VIR-32 (WITH TO-FROM METER ONLY)	ASI DEALER
ASI-200-2D			ASI-2000 PLUG IN VIR-32 FOR USE WITH ASI-160() OR ASI-161 (479V-3)	ASI DEALER
ASI-200-3			ASI-2000 PLUG IN FOR VHF-21 / VHF-22	ASI DEALER
ASI-200-4			ASI-2000 PLUG IN FOR CAD-31 / CAD-62	ASI DEALER
ASI-200-5			ASI-2000 PLUG IN FOR DME-42 / IND-42	ASI DEALER
ASI-200-5A1		647-6787-001	DME SIM CARD AND CASE	ASI DEALER
ASI-200-6			ASI-2000 PLUG IN FOR CTL-230	ASI DEALER
ASI-200-7			ASI-2000 PLUG IN FOR KING KFS	ASI DEALER
ASI-200-8			ASI-2000 PLUG IN FOR ARINC COMM	ASI DEALER
ASI-200-9			ASI-2000 PLUG IN FOR ARINC NAV	ASI DEALER
ASI-200-10			ASI-2000 PLUG IN FOR ADF-60A, ADF-60B, ADF-462	ASI DEALER
ASI-200-11			ASI-2000 PLUG IN FOR VHF-422	ASI DEALER
ASI-200-12			ASI-2000 PLUG IN FOR VIR-432	ASI DEALER
ASI-200-13			ASI-2000 PLUG IN FOR DME-442	ASI DEALER
ASI-200-14			ASI-2000 PLUG IN FOR TDR-90 AND CAD-870G	ASI DEALER
ASI-200-15			ASI-2000 PLUG IN FOR DDA-42	ASI DEALER
ASI-200-16			ASI-2000 PLUG IN FOR KDM-706A	ASI DEALER
ASI-200-17			ASI-2000 PLUG IN FOR RTU-870 (THIS ITEM HAS BE REPLACED BY THE ASI-200-17A)	ASI DEALER
ASI-200-17A			ASI-2000 PLUG IN FOR RTU-870A	ASI DEALER
ASI-200-18			ASI-2000 PLUG IN FOR CAD-870/RAC-870	ASI DEALER
ASI-200-19			ASI-2000 PLUG IN FOR BIA-32	ASI DEALER
ASI-200-20			ASI-2000 PLUG IN FOR ALT-50A, 55B, 860F-2	ASI DEALER
ASI-200-21			ASI-2000 PLUG IN FOR CTL-X0 AND CTL-X1	ASI DEALER
ASI-200-22			ASI-2000 PLUG IN FOR BRG-40	ASI DEALER
ASI-200-23			ASI-2000 PLUG IN FOR ARINC GLIDE SLOPE	ASI DEALER
ASI-200-24			ASI-2000 PLUG IN FOR ARINC DME	ASI DEALER
ASI-200-25			ASI-2000 PLUG IN FOR ARINC TRANSPONDER	ASI DEALER
ASI-200-26			ASI-2000 PLUG IN FOR ARINC MARKER BEACON	ASI DEALER
ASI-200-27			ASI-2000 PLUG IN FOR CTL-92T	ASI DEALER
ASI-200-28			ASI-2000 PLUG-IN PROLINE CARD SELF-TEST MODULE	ASI DEALER
ASI-200-29			ASI-2000 PLUG-IN FOR VHF-4000	ASI DEALER
ASI-200-30			ASI-2000 PLUG-IN FOR NAV-4000	ASI DEALER
ASI-200-31			ASI-2000 PLUG-IN FOR DME-4000	ASI DEALER
ASI-200-32			ASI-2000 PLUG-IN FOR CMU-4000	ASI DEALER
ASI-200-33			ASI-2000 PLUG-IN FOR ALT-4000	ASI DEALER
ASI-200-1664-00		200-1664-00	CABLE KIT FOR KTS-146 / INCL 4 CABLES IN A CASE (ASI-200-1664-01/-02/-03/-04)	ASI DEALER
ASI-200-1664-01		200-1664-01	CABLE FOR KTS-146	ASI DEALER
ASI-200-1664-02		200-1664-02	CABLE FOR KTS-146	ASI DEALER
ASI-200-1664-03		200-1664-03	CABLE FOR KTS-146	ASI DEALER
ASI-200-1664-04		200-1664-04	CABLE FOR KTS-146	ASI DEALER
ASI-200-7157-00	200-7157-00	200-07157-0000	ASYNC CARD ONLY (SEE ASI-050-2605-00 FOR ASYNC CARD KIT WITH CABLES)	ASI DEALER
ASI-200-7164-00	200-7164-00	200-07164-0000	SYNC CARD ONLY (SEE ASI-050-2606-00 FOR SYNC CARD KIT WITH CABLES)	ASI DEALER
ASI-201-1	AN/ARM-93	522-4458-001	ADF SYSTEM TEST SET FOR ARN-83 (NSN 6625-00-999-5119)	ASI DEALER
ASI-201-1TS	TS-2502/ARM-93	762-1675-001	ADF TEST SET / P/O ASI-201-1 (NSN 6625-00-999-6080)	ASI DEALER
ASI-201-2	477U-3	522-4458-002	ADF SYSTEM TEST SET FOR DF-203 ADF SYSTEM	ASI DEALER
ASI-202-1	DFT-73AA	2064943-0501	ADF SYSTEM TEST PANEL	ASI DEALER
ASI-202-2	DFT-73C1	2070555-0501	ADF SYSTEM TEST SET	ASI DEALER
ASI-203	980N-1	522-4610-004	RADIO ALTIMETER TEST SET	ASI DEALER
ASI-203-A1		622-4055-002	RATE GENERATOR CARD FOR ASI-203 / 980N-1 / 522-4610-004	ASI DEALER
ASI-203-M1K			980N-1 METER (M1) RETROFIT KIT FOR 458-0815-040	ASI DEALER
ASI-203-TA	699N-1	797-0299-001	980N-1 / ASI-203 / 80N-1A TEST ADAPTER (980N-1 MAN FIG 7-24 & 7-25)	ASI DEALER
ASI-204	972S-1	622-1626-001	AUTOPILOT RAMP TEST SET FOR AP-106, AP-107	ASI DEALER
ASI-204-91523-1		204-91523-1	CABLE SET: FIRE WARNING TEST	ASI DEALER
ASI-205	972S-2	622-1628-001	AUTOPILOT BENCH TEST SET FOR AP-106, AP-107	ASI DEALER
ASI-205-2			TEST SET: 454N-3 TRIM SERVO MONITOR	ASI DEALER
ASI-205-3			TEST SET: 454N-2/2D RATE LEVEL SENSOR	ASI DEALER

AVAILABILITY:

ASI DEALER: CONTACT ANY ASI DEALER FOR QUOTE
 COLLINS: CONTACT ROCKWELL COLLINS FOR QUOTE
 GABLES: CONTACT GABLES ENGINEERING FOR QUOTE
 TELEPHONICS: CONTACT TELEPHONICS FOR QUOTE

ASI SPECIALIZED TEST EQUIPMENT LIST

AVAILABILITY SUBJECT TO CHANGE WITHOUT NOTICE

<u>ASI MN</u>	<u>EQUIV MN</u>	<u>EQUIV PN</u>	<u>DESCRIPTION</u>	<u>AVAILABILITY</u>
ASI-205-4			TEST SET: AP-106/107 ANNUNCIATOR UNIT	ASI DEALER
ASI-205-5			TEST SET: 998E-1 ANNUNCIATOR ADAPTER	ASI DEALER
ASI-205-6	999U-1	622-3635-001	TEST SET ADAPTER	ASI DEALER
ASI-206	972S-3	622-2562-001	SERVO TEST SET FOR AP-106, AP-107	ASI DEALER
ASI-207	477W-7	622-0158-001	TEST BENCH HARNESS (INCLUDES 678P-5, 172H-18, AND 7 CABLES)	ASI DEALER
ASI-207-1	172H-18	622-0180-001	DUMMY ANTENNA SHUNT	ASI DEALER
ASI-207-1-220	172H-18	622-0180-001	DUMMY ANTENNA SHUNT (220 VAC)	ASI DEALER
ASI-207-2	678P-5	622-0304-001	RADIO TEST SET HARNESS	ASI DEALER
ASI-207-3			CPL-920D RF HIGH VOLTAGE TEST FIXTURE (REQUIRES SPECIAL CALIBRATION)	ASI DEALER
ASI-207-4	967R-2	822-1176-001	CPL-920D CONTROL CARD TEST SET	ASI DEALER
ASI-207-5	TE1	752-8896-001	CPL-920D POWER SUPPLY TEST FIXTURE (INCLUDES W1 AND W2)	ASI DEALER
ASI-207-6	TE2	989-2159-001	CPL-920D MIMS/DISCRIMINATOR TEST FIXTURE	ASI DEALER
ASI-207-6-1		989-2159-006	CPL-920D MIMS/SENSOR ASSY TOP TEST COVER (P/O ASI-207-6)	ASI DEALER
ASI-207-6-2		989-2159-007	CPL-920D MIMS/SENSOR ASSY TEST COIL TOP COVER (P/O ASI-207-6)	ASI DEALER
ASI-207-6-3		989-2159-008	CPL-920D MIMS/SENSOR ASSY BOTTOM TEST COVER (P/O ASI-207-6)	ASI DEALER
ASI-207-6-4		989-2159-011	CPL-920D SMB COAX TEST JUMPER (P/O ASI-207-6)	ASI DEALER
ASI-207-6-5		989-2159-012	CPL-920D SMB COAX TEST JUMPER (P/O ASI-207-6)	ASI DEALER
ASI-207-6-6		989-2159-015	CPL-920D COAX TEST CONNECTOR	ASI DEALER
ASI-207-7	TE3	989-2167-001	CPL-920D RF NETWORK TEST FIXTURE	ASI DEALER
ASI-207-8	TE4	989-2168-001	CPL-920D RF NETWORK HOLDING FIXTURE	ASI DEALER
ASI-207-8-1		989-2168-009	CPL-920D RF TEST CABLE (P/O ASI-207-8)	ASI DEALER
ASI-207-8-2		989-2168-010	CPL-920D RF TEST CABLE (P/O ASI-207-8)	ASI DEALER
ASI-207-9	TE5	989-2169-001	CPL-920D CALIBRATION FIXTURE	ASI DEALER
ASI-207-10		989-2146-001	CPL-920D 90 DEGREE PHASE SHIFT NETWORK	ASI DEALER
ASI-207-11		989-2146-002	CPL-920D 0 DEGREE POWER DIVIDER	ASI DEALER
ASI-207-12		989-2146-007	CPL-920D RF TEST CABLE (2 REQUIRED)	ASI DEALER
ASI-207-13		652-2443-001	CPL-920D TEST ADAPTER	ASI DEALER
ASI-207-14-1			CPL-920D A2 CARD DRILL FIXTURE NO 1	ASI DEALER
ASI-207-14-2			CPL-920D A2 CARD DRILL FIXTURE NO 2	ASI DEALER
ASI-207-15		988-3779-001	CPL-920D BURN IN ADAPTER	COLLINS
ASI-208	980H-5	777-1526-001	ANTENNA COUPLER TEST SET	ASI DEALER
ASI-208-1	878L-19D	622-0226-001	DISCRIMINATOR TEST SET	ASI DEALER
ASI-208-2		617-9736-001	POWER PANEL	ASI DEALER
ASI-208-3	878L-39	622-0227-001	SERVO-POWER SUPPLY TEST SET	ASI DEALER
ASI-208-3-1		609-9498-001	EXTENDER FIXTURE, CARD (P/O ASI-208-3)	ASI DEALER
ASI-208-4	878L-40	622-0228-001	TUNER-CHASSIS TEST SET	ASI DEALER
ASI-208-5	878L-41	622-0229-001	LOGIC CARD TEST SET	ASI DEALER
ASI-208-6	973K-1	622-0377-001	ANTENNA COUPLER GROUP TEST SET (INCL ASI-208-1,-2,-3,-4)	ASI DEALER
ASI-209-1	678P-1	547-3914-00	REPLACED BY ASI-209-1A / 678P-1A	ASI DEALER
ASI-209-1A	678P-1A	547-3914-000	RADIO SET TEST HARNESS (6625-00-674-4860)	ASI DEALER
ASI-209-1B	678P-1B	777-1861-001	RADIO SET TEST HARNESS	ASI DEALER
ASI-209-1C	678P-1C	622-4211-001	RADIO SET TEST HARNESS	ASI DEALER
ASI-209-2	678P-2	522-3400-005	REPLACED BY ASI-209-2A / 678P-2A	ASI DEALER
ASI-209-2A	678P-2A	522-3400-005	RADIO SET TEST HARNESS (6625-01-064-6671)	ASI DEALER
ASI-209-2B	678P-2B	792-6229-001	RADIO SET TEST HARNESS (6625-00-064-1557 / AN/URM-157A)	ASI DEALER
ASI-209-2C	678P-2C	522-3400-007	REPLACED BY ASI-209-2A / 678P-2A	ASI DEALER
ASI-209-2D	678P-2D	522-3400-006	RADIO SET TEST HARNESS WITH CONTROL (6625-00-766-4685 / AN/URM-157)	ASI DEALER
ASI-209-6		635-6382-001	678P-1/2 (ASI-209-X) TEST SET ADAPTER FOR 628T-1/1B	ASI DEALER
ASI-209-7			628T-1/1B CONNECTOR BREAKOUT BOX (MAN FIG 902)	ASI DEALER
ASI-209-8		642-6964-011	678P-1/2 (ASI-209-X) TEST SET ADAPTER FOR 628T-2/2A (MAN FIG 906)	ASI DEALER
ASI-209-9		642-6964-010	628T-2/2A TEST POINT BREAKOUT BOX (MAN FIG 908)	ASI DEALER
ASI-209-10		642-7952-001	678P-1/2 (ASI-209-X) TEST SET ADAPTER FOR 628T-3/3A (MAN FIG 905-906)	ASI DEALER
ASI-209-11			628T-3/3A/3B ATE CONNECTOR BREAKOUT BOX (MAN FIG 902)	ASI DEALER
ASI-210			AL-101 RADIO ALTIMETER RAMP TEST SET	ASI DEALER
ASI-211			DSA-220/LWA-200 DUAL SYSTEM TEST SET	ASI DEALER
ASI-212-1	960M-1	622-0471-001	TORQUE TESTER FOR 334C-6(), SVO-80()	ASI DEALER
ASI-212-2	960M-2	622-2094-001	TORQUE TESTER FOR 334C-9/9A, 334D-6()	ASI DEALER
ASI-212-3	960M-3	622-2741-001	TORQUE TESTER FOR 334C-9/9A/11/12H, 334D-6()	ASI DEALER
ASI-212-4	960M-4	622-5434-001	TORQUE TESTER FOR SVO-85(), SVO-1000()	ASI DEALER
ASI-212-5	960M-5	622-6454-001	TORQUE TESTER FOR SVO-65, SVO-75, SVT-1000A/B	ASI DEALER
ASI-213-1		608-3617-001	SERVO LOOP TEST SET FOR 334C-6/SVO-80	ASI DEALER
ASI-213-2		637-0789-001	MINIMUM PERFORMANCE TEST SET FOR 334C-6/SVO-80	ASI DEALER
ASI-214			TDR-94/94D FLIGHT LINE TEST SET (REQUIRES ASI-21-4X TEST KITS)	ASI DEALER
ASI-215			ZEROING AND TRACKING TEST PANEL	ASI DEALER
ASI-216			INTERNAL DATA BUS SIMULATOR	ASI DEALER
ASI-217			VHF-20() / VHF-21() TEST PANEL	ASI DEALER
ASI-218			DRI-55 TEST PANEL	ASI DEALER
ASI-219			ILS-70 TEST PANEL	ASI DEALER
ASI-220			TEST SET FOR COLLINS CTL-92T	ASI DEALER

AVAILABILITY:

ASI DEALER: CONTACT ANY ASI DEALER FOR QUOTE
 COLLINS: CONTACT ROCKWELL COLLINS FOR QUOTE
 GABLES: CONTACT GABLES ENGINEERING FOR QUOTE
 TELEPHONICS: CONTACT TELEPHONICS FOR QUOTE

ASI SPECIALIZED TEST EQUIPMENT LIST

AVAILABILITY SUBJECT TO CHANGE WITHOUT NOTICE

<u>ASI MN</u>	<u>EQUIV MN</u>	<u>EQUIV PN</u>	<u>DESCRIPTION</u>	<u>AVAILABILITY</u>
ASI-221-1	968Y-1		51R/51RV NAV RECEIVER (ARINC 547 VOR/ILS) TEST PANEL	ASI DEALER
ASI-221-2			618M COM RECEIVER (ARINC 566/566A) TEST PANEL	ASI DEALER
ASI-222-1			346D-1/2/2B TEST PANEL (INCLUDES ALL LOAD RESISTORS AND SPKR PANEL)	ASI DEALER
ASI-222-2			MONITOR SPEAKER PANEL	ASI DEALER
ASI-222-3			346D-1/2/2B TEST PANEL (SPECIAL MOD FOR KLM WITHOUT SPKR FUNCTIONS)	ASI DEALER
ASI-223	478A-3	622-3701-001	ZIFOR III VOR RADIAL STANDARD	ASI DEALER
ASI-224	972V-1	622-1789-001	TACAN TEST SET (INCLUDES ASI-224-1/-2/-3/W1/W2/W3/W4/W5/W6/W7)	ASI DEALER
ASI-224-1	255H-1	629-0973-001	INTERCONNECT PANEL	ASI DEALER
ASI-224-2	514M-1	622-1931-002	CONTROL DISPLAY UNIT	ASI DEALER
ASI-224-3		621-8100-002	FAULT ISOLATION PANEL	ASI DEALER
ASI-224-4	255H-1	622-1930-001	INTERCONNECT PANEL WITH CHASSIS	ASI DEALER
ASI-225		687-8450-001	TACAN TEST SET ADAPTER (972V-1 TO 899L-1)	ASI DEALER
ASI-225-1			ALIGNMENT FIXTURE FOR THE 899L-1 / 998J-1	ASI DEALER
ASI-225-2			TACAN DC SUPPLY INTERFACE FIXTURE FOR 374D-1/2	ASI DEALER
ASI-225-3			TACAN AGE CONNECTOR BREAKOUT BOX FOR 374D-1/-2	ASI DEALER
ASI-226	514M-2	622-7082-001	INTERFACE PANEL FOR 972V-1 TACAN TEST SET	ASI DEALER
ASI-227		024-0458-000	TUNING TOOL (GC-8605 / 00-8605-0000)	ASI DEALER
ASI-228		024-0817-010	TUNING TOOL	ASI DEALER
ASI-229			614E-10() FMC-28() MODE SEL SWITCH ADJ FIXTURE (614E-10 MAN FIG 1004)	ASI DEALER
ASI-230		229-0223-030	FLUX KEEPER RING (1-1/8" DIA)	COLLINS
ASI-231			339H-1 SPECIAL TEST FIXTURE (339H-1 MAN FIG 1003 - 1006) REPLACED BY ASI-231-1	ASI DEALER
ASI-231R			339H-1 SPECIAL TEST PANEL (339H-1 MAN FIG 1003 - 1006) REPLACED BY ASI-231-1	ASI DEALER
ASI-231-1	974G-1	797-0097-001	RADIO ALTIMETER INDICATOR TEST PANEL FOR 339H-1()	ASI DEALER
ASI-232		229-9515-050	MAGNET KEEPER (1-13/16" DIA)	ASI DEALER
ASI-233			51Y-7 RF BAL ADJ TEST FIXTURE (51Y-7 MAN FIG 1002 - 1004)	ASI DEALER
ASI-234			51Y-7 50 OHM PROBE (51Y-7 MAN FIG 1005)	ASI DEALER
ASI-235			51Y-7 / 490S-1 SPECIAL SOLDER TIP	ASI DEALER
ASI-236			51Z-4 TEST AND ALIGN JIG (51Z-4 MAN FIG 1002)	ASI DEALER
ASI-237			860F-1/4 RADIO ALTIMETER TEST FIXTURE (860F-4 MAN FIG 903-907)	ASI DEALER
ASI-238			860F-1/4 TRANSMITTER ALIGNMENT TOOL (860F-4 MAN FIG 911)	ASI DEALER
ASI-239		635-6254-001	860F-1/4 SPECIAL WRENCH	ASI DEALER
ASI-240			860F-1/4 RF CABLE (INCLUDES 2 ATTACHED 15 FT RF CABLES)	ASI DEALER
ASI-241	MST-901	622-6100-001	MICROPROCESSOR SYSTEM TEST SET ADAPTER	ASI DEALER
ASI-242			621A-6() TEST FIXTURE (621A-6() MAN FIG 1003)	ASI DEALER
ASI-242R			621A-3/6() TEST PANEL (621A-6() MAN FIG 1003)	ASI DEALER
ASI-243			614L-12 BREAKOUT BOX	ASI DEALER
ASI-244-1	PPT-1FB	2041350-0101	RADAR INDICATOR TEST PANEL	ASI DEALER
ASI-244-2	PPT-1FB	2041350-0102	RADAR INDICATOR TEST PANEL	ASI DEALER
ASI-244-3		2039817-0501	CON-1FB TEST ADAPTER	ASI DEALER
ASI-244-4		8050799-0501	CON-1TB TEST ADAPTER AND CABLE	ASI DEALER
ASI-245	700D-2A	622-0147-001	THRESHOLD DETECTOR FOR 971T-1	ASI DEALER
ASI-246-1		621-9185-001	CAPSTAN TEST FIXTURE FOR 334C-9/9A/11	ASI DEALER
ASI-246-2		621-9185-002	CAPSTAN TEST FIXTURE FOR SVO-65() AND SVO-75	ASI DEALER
ASI-246-3	997T-1	822-0030-001	TEST ADAPTER FOR SMT-85/-86/-87	ASI DEALER
ASI-247		634-0549-001	YAW DAMPER TEST FIXTURE	ASI DEALER
ASI-248			AIU-4000 TEST PANEL	ASI DEALER
ASI-249		676-1949-001	SVT-1000 TEST PANEL / RUN-IN FIXTURE	ASI DEALER
ASI-250		685-6220-001	590B-2 TEST AID	ASI DEALER
ASI-251		685-6295-001	CTS-859 TERMINAL TO IBM SWITCH UNIT (ALT PN 628-8839-001)	ASI DEALER
ASI-252-1	COT-1FB	2041348-0101	RADAR CONTROL TEST PANEL	ASI DEALER
ASI-252-2	COT-4A	2041593-0401	RADAR CONTROL TEST PANEL	ASI DEALER
ASI-253			JET GYRO TEST PANEL	ASI DEALER
ASI-254			CHP-850() TEST SET	ASI DEALER
ASI-255			APP-850 TEST SET	ASI DEALER
ASI-256		652-5939-001	SERVO CALIBRATION FIXTURE	ASI DEALER
ASI-257	CTS-451	622-3882-001	S-TEC DME-451 TEST SET	ASI DEALER
ASI-257-2	CTS-351	622-3883-001	S-TEC ANS-351 TEST SET	ASI DEALER
ASI-258-1			339H-6 (-001) TEST FIXTURE (339H-6 MAN FIG 902 - 903)	ASI DEALER
ASI-258-2			339H-6 TEST FIXTURE (339H-6 MAN FIG 904 - 905)	ASI DEALER
ASI-259-L			TAPE WINDING FIXTURE - LEFT (339H-6 MAN FIG 913, 915 - 918)	ASI DEALER
ASI-259-R			TAPE WINDING FIXTURE - RIGHT (339H-6 MAN FIG 914 - 918)	ASI DEALER
ASI-260-1		T321703	TARSYN/VG-14 FINAL TEST FIXTURE	ASI DEALER
ASI-260-2		T321705	TARSYN/VG-14 FIELD TEST FIXTURE	ASI DEALER
ASI-261			AVQ-30 X AND C BAND RADAR SYSTEM TEST PANEL	ASI DEALER
ASI-262			AVQ-10 C BAND RADAR SYSTEM TEST PANEL	ASI DEALER
ASI-263	HWX-650/870	T334612	PRIMUS-450/650/870 RADAR TEST PANEL	ASI DEALER
ASI-263-2	HWX-660/880	T336162	PRIMUS-331/440/660/880 RADAR TEST SET	ASI DEALER
ASI-263-3	ADS-100	7015457-901	AIR DATA SIMULATOR	ASI DEALER
ASI-263-4			RS-232 ADAPTER FOR WU-870 (PRE MOD N UNITS ONLY)	ASI DEALER

AVAILABILITY:

ASI DEALER: CONTACT ANY ASI DEALER FOR QUOTE
 COLLINS: CONTACT ROCKWELL COLLINS FOR QUOTE
 GABLES: CONTACT GABLES ENGINEERING FOR QUOTE
 TELEPHONICS: CONTACT TELEPHONICS FOR QUOTE

ASI SPECIALIZED TEST EQUIPMENT LIST

AVAILABILITY SUBJECT TO CHANGE WITHOUT NOTICE

<u>ASI MN</u>	<u>EQUIV MN</u>	<u>EQUIV PN</u>	<u>DESCRIPTION</u>	<u>AVAILABILITY</u>
ASI-264		T334822	WC-874 EFIS AUX. CONN TEST BOX	ASI DEALER
ASI-265	CBM-100	7012364	BUS MONITOR (WR-800 MAN FIG 901)	ASI DEALER
ASI-266	HWX-800	T334714	PRIMUS-800 RADAR TEST PANEL	ASI DEALER
ASI-266-2	HWX-700	7015455-901	PRIMUS-700/701 RADAR TEST PANEL	ASI DEALER
ASI-266-2A	HWX-700A	T337333	PRIMUS-700/700A/701/701A RADAR TEST PANEL (REPLACES ASI-266-2)	ASI DEALER
ASI-266-3	ACI-100	7016068-901	ACCESS INTERFACE FOR PRIMUS-700/701	ASI DEALER
ASI-266-4		7010571-901	MODULATOR DUMMY LOAD FOR PRIMUS RADAR	ASI DEALER
ASI-266-5		7015904-904	DIGITAL PROTRACTOR ADAPTER	ASI DEALER
ASI-267	GSM-100	7010568-901	GYRO SIMULATOR	ASI DEALER
ASI-268			TARGET SIMULATOR (PRIMUS-450/650/870)	ASI DEALER
ASI-269			TWR-850 RADAR TEST PANEL (REPLACED BY ASI-CTS-841)	ASI DEALER
ASI-269-1A		135-3603-026	DIAL INDICATOR MOUNTING POST (3 INCH)	ASI DEALER
ASI-269-1B		135-3603-027	DIAL INDICATOR MOUNTING POST (6 INCH)	ASI DEALER
ASI-269-2			TILT ANGLE MOUNTING FIXTURE	ASI DEALER
ASI-269-3			TILT/SCAN ANGLE MEASUREMENT ADAPTER	ASI DEALER
ASI-269-4		827-2780-001	TILT SECTOR GEAR PULLER	ASI DEALER
ASI-269-5A		827-2781-001	SCAN SECTOR GEAR PULLER	ASI DEALER
ASI-269-5B		626-4247-001	SCAN SECTOR GEAR PULLER	ASI DEALER
ASI-269-6			FLUKE 9010A TEST ADAPTER	ASI DEALER
ASI-269-7			TILT TORSION SPRING INSTALLATION/REMOVAL TOOL	ASI DEALER
ASI-269-8		815-2274-001	BUFFER ADAPTER (W/2 CABLES)	ASI DEALER
ASI-269-9			RF TEST CABLE SET (INCLUDES CABLES: A,A,A,B,D,E,F,G,H,J,K,L,L,M,N,P,Q,R,S)	ASI DEALER
ASI-270-1		MI-592189	AVQ-30 RADAR R-T MODULE TEST PANEL	ASI DEALER
ASI-270-2		MI-592188	AVQ-30 RADAR ANTENNA TEST PANEL	ASI DEALER
ASI-270-3		MI-592187	AVQ-30 RADAR INDICATOR TEST PANEL	ASI DEALER
ASI-270-4		MI-592186	AVQ-30 RADAR R-T TEST PANEL	ASI DEALER
ASI-271		828-2551-002	INCIRCUIT PROGRAMMER	COLLINS
ASI-272			CTC-429-P1 BREAKOUT BOX (THIS HAS BEEN REPLACED BY THE ASI-402)	ASI DEALER
ASI-273		TSH-4D	FLITEFONE TEST SET	ASI DEALER
ASI-274		WB-1	FLITEFONE AUXILIARY BELL ASSEMBLY	ASI DEALER
ASI-275-1		T307976	DG-401 PRELIMINARY AND C14 FINAL TEST FIXTURE	ASI DEALER
ASI-275-2		T307977	DG-401 CALIBRATION FIXTURE	ASI DEALER
ASI-276	477N-1	522-1149-000	STEERING COMPUTER TEST PANEL	ASI DEALER
ASI-276A	477N-1A	522-3328-000	STEERING COMPUTER TEST PANEL	ASI DEALER
ASI-277			TYPE W MAGNETIC AMPLIFIER TEST PANEL (477N-1 MAN FIG 1003)	ASI DEALER
ASI-278	969W-1	622-3874-001	ADF ANTENNA TESTER	ASI DEALER
ASI-280			51R-10() / 51RV-4() CPU TEST SET (MAN FIG 911 - 912)	ASI DEALER
ASI-281			FPA-80 TEST PANEL	ASI DEALER
ASI-282	980L-1A	622-0846-001	UNIVERSAL FLIGHT CONTROL TEST PANEL MAIN FRAME	ASI DEALER
ASI-282-M1K			METER RETROFIT KIT FOR ASI-282/980L-1A	ASI DEALER
ASI-283			DME-40 TROUBLESHOOTING PROBE (MAN PG 5-47 FIG 8)	ASI DEALER
ASI-284			KFS-578A CONTROL TEST PANEL (KFS-578A MAN FIG 5-2)	ASI DEALER
ASI-285	477P-1A	522-3329-000	APPROACH HORIZON TEST SET	ASI DEALER
ASI-285-1	477P-1	522-1150-000	APPROACH HORIZON TEST SET	ASI DEALER
ASI-286-1	CTS-82	622-4562-001	AUTOPILOT TEST SET (INCLUDES 10 CABLES, ASI-28-6A THRU ASI-28-6J)	ASI DEALER
ASI-286-2	CTS-82	622-4562-002	AUTOPILOT TEST SET (DOES NOT INCLUDE CABLES)	ASI DEALER
ASI-287	CT2542		PNEUMATIC SYSTEM CONTROLLER TEST PANEL	ASI DEALER
ASI-288	968A-1	622-3962-001	FLIGHT MODE CONTROL TEST PANEL	ASI DEALER
ASI-289-1	CTS-231	622-5188-001	OUTPUT MONITOR TEST PANEL	ASI DEALER
ASI-289-2	CTS-232	622-5189-001	MONITOR / NCS SIMULATOR TEST PANEL	ASI DEALER
ASI-290	969T-1	622-3868-001	GPWS TEST SET	ASI DEALER
ASI-291	968J-1	622-4369-001	AUDIO CONTROL TEST PANEL (FOR CPN 622-4149-001)	ASI DEALER
ASI-292	968W-1	622-4725-001	DME-40 TEST PANEL	ASI DEALER
ASI-293	968X-1	622-4726-001	639U-1 TEST PANEL	ASI DEALER
ASI-294-1	970D-2	622-3304-001	AIR DATA ELECTRONIC TEST SET	ASI DEALER
ASI-294-2	970D-2A	622-8624-001	AIR DATA ELECTRONIC TEST SET	ASI DEALER
ASI-295	971K-1	522-2011-001	AREA NAVIGATION TEST SET	ASI DEALER
ASI-296-1	971T-1	622-2640-001	FLIGHT PROFILE COMPARATOR TEST PANEL (WITH SYNCHRO GENERATOR)	ASI DEALER
ASI-296-2	971T-1	622-2640-002	FLIGHT PROFILE COMPARATOR TEST PANEL (WITHOUT SYNCHRO GENERATOR)	ASI DEALER
ASI-297	CTS-300	622-4946-001	GENERATOR TEST PANEL	ASI DEALER
ASI-298	CTS-301	622-5225-001	RADAR NAV TEST SET	ASI DEALER
ASI-299		828-8249-001	ALT-1000/4000F-55B TEST PANEL	ASI DEALER
ASI-299-1			ALT-50A/55B/860F-2 XMTR/MOD TEST FIXTURE	ASI DEALER
ASI-299-2		618-1673-002	ALT-50A/55B/860F-2 TRANSMITTER DUST COVER FIXTURE	ASI DEALER
ASI-300	973W-2	622-5058-001	ARC-182() R/T TEST SET	ASI DEALER
ASI-301	973W-3	622-6121-001	RADIO TEST SET	ASI DEALER
ASI-301-8	973W-8	622-7009-001	RADIO TEST SET / MIL MN: TS-4110/ARC	COLLINS
ASI-301-10	973W-10	822-1512-001	ARC-210 RADIO TEST SET	COLLINS
ASI-302	966B-1	622-5479-001	AMPLIFIER-PWR SPLY TEST SET	ASI DEALER

AVAILABILITY:

ASI DEALER: CONTACT ANY ASI DEALER FOR QUOTE
 COLLINS: CONTACT ROCKWELL COLLINS FOR QUOTE
 GABLES: CONTACT GABLES ENGINEERING FOR QUOTE
 TELEPHONICS: CONTACT TELEPHONICS FOR QUOTE

ASI SPECIALIZED TEST EQUIPMENT LIST

AVAILABILITY SUBJECT TO CHANGE WITHOUT NOTICE

ASI MN	EQUIV MN	EQUIV PN	DESCRIPTION	AVAILABILITY
ASI-303	966B-2	622-5480-001	RECEIVER TEST SET	ASI DEALER
ASI-304	966B-3	622-5481-001	SYNTHESIZER TEST SET	ASI DEALER
ASI-305	966B-4	622-5482-001	CONTROL PROCESSOR TEST SET (TEST ADAPTERS ARE SOLD SEPERATE)	ASI DEALER
ASI-306	966B-6	622-5484-001	RADIO SET CONTROL TEST SET	ASI DEALER
ASI-307	966B-7	622-5485-001	RADIO SET CONTROL (HALF SIZE) TEST SET	ASI DEALER
ASI-308-1	AN/ARM-165	623-5403-001	RADIO SET TEST PANEL	ASI DEALER
ASI-308-2	AN/ARM-165A	622-2750-001	RADIO SET TEST PANEL	ASI DEALER
ASI-309	964R-3	659-3488-001	1553 ADDRESS BOX WITH CABLE FOR VCT-186B	ASI DEALER
ASI-310	438K-2	622-5731-001	MAINTENANCE KIT FOR RT1272(V)2	ASI DEALER
ASI-310-2C	438K-2C	622-9663-001	MAINTENANCE KIT FOR RT1272D	ASI DEALER
ASI-311	TS-3488	623-5465-001	CONTROL TEST SET	ASI DEALER
ASI-312	TS-3487	623-5464-001	POWER AMPLIFIER/POWER SUPPLY TEST SET	ASI DEALER
ASI-313	MX-9626/ARM	623-5404-001	TRANSLATOR MODULE EXTENDER	ASI DEALER
ASI-314		647-8457-001	TEST INTERFACE ADAPTER	ASI DEALER
ASI-315	970T-1A	622-5672-001	A7 FILTER TEST SET	ASI DEALER
ASI-316	970T-2	622-1796-001	D/A SERVO MODULE TEST SET	ASI DEALER
ASI-316A	970T-2A	622-5673-001	D/A SERVO MODULE TEST SET	ASI DEALER
ASI-317	970T-3	622-1797-001	SYNTHESIZER TEST SET	ASI DEALER
ASI-317A	970T-3A	622-5674-001	SYNTHESIZER TEST SET	ASI DEALER
ASI-317B	970T-3B	622-6396-001	SYNTHESIZER TEST SET	ASI DEALER
ASI-317C	970T-3C	622-7201-001	SYNTHESIZER TEST SET	ASI DEALER
ASI-318B	970T-4B	622-6871-001	A3 RF RECEIVER TEST SET	ASI DEALER
ASI-319	970T-5	622-1799-001	AUDIO MODULE TEST SET	ASI DEALER
ASI-319A	970T-5A	622-5676-001	AUDIO MODULE TEST SET	ASI DEALER
ASI-320	970T-8	622-1812-001	DC-DC CONVERTER TEST SET	ASI DEALER
ASI-321A	969N-1A	622-5532-001	AUDIO TEST FIXTURE	ASI DEALER
ASI-321A-P1			ASI-321A (969N-1A) SHORTING PLUG P1 (INCLUDED WITH ASI-321A)	ASI DEALER
ASI-321A-P2			ASI-321A (969N-1A) SHORTING PLUG P2 (INCLUDED WITH ASI-321A)	ASI DEALER
ASI-321A-P3			ASI-321A (969N-1A) SHORTING PLUG P3 (INCLUDED WITH ASI-321A)	ASI DEALER
ASI-321A-P4			ASI-321A (969N-1A) 619 OHM AUDIO LOAD P4 (INCLUDED WITH ASI-321A)	ASI DEALER
ASI-321A-P5			ASI-321A (969N-1A) 619 OHM AUDIO LOAD P5 (INCLUDED WITH ASI-321A)	ASI DEALER
ASI-321A-P6			ASI-321A (969N-1A) 10K DATA LOAD P6 (INCLUDED WITH ASI-321A)	ASI DEALER
ASI-321A-P7			ASI-321A (969N-1A) 10K DATA LOAD P7 (INCLUDED WITH ASI-321A)	ASI DEALER
ASI-321B	969N-1B	622-5655-001	AUDIO TEST FIXTURE	ASI DEALER
ASI-321D	969N-1D	622-8014-001	AUDIO TEST FIXTURE (ALT MN: TS-4415/GRM)	ASI DEALER
ASI-322		687-8450-001	THIS ITEM HAS BEEN REPLACED BY THE ASI-225	ASI DEALER
ASI-323-1	966D-5	622-5635-001	RADIO SET TEST SET (OBSOLETE-REPLACED BY ASI-323-21 OR ASI-323-3)	ASI DEALER
ASI-323-2	966D-5A	622-7574-001	RADIO SET TEST SET (OBSOLETE-REPLACED BY ASI-323-21 OR ASI-323-3)	ASI DEALER
ASI-323-21	966D-5A	622-7574-002	RADIO SET TEST SET	ASI DEALER
ASI-323-3	966D-5B	622-9034-001	RADIO SET TEST SET	ASI DEALER
ASI-323-31		751-2239-001	ADAPTER A7 (INCLUDED WITH ASI-323-3)	ASI DEALER
ASI-323-4		647-7983-001	EXTENDER KIT FOR RADIO SET CONTROL (INCL WITH ASI-323-2/21-3)	ASI DEALER
ASI-324	964R-2	822-0742-001	1553 ADDRESS BOX, INCLUDES CABLE	ASI DEALER
ASI-324-1	964R-3	639-3488-001	1553 ADDRESS BOX FOR VHF-186, INCLUDES CABLE (CPN WRONG / SEE ASI-309)	ASI DEALER
ASI-325			346B-3 TEST FIXTURE (MAN FIG 1002)	ASI DEALER
ASI-326			RTU-40X0 CONDUCTIVITY TEST AID (RTU-4000 MAN FIG 902)	ASI DEALER
ASI-327-1	977A-1	777-1356-001	TEST PANEL (SEE ASI-221-1 FOR EQUIVALENT TEST PANEL)	ASI DEALER
ASI-327-2	977B-1	777-1357-001	TEST PANEL (SEE ASI-221-2 FOR EQUIVALENT TEST PANEL)	ASI DEALER
ASI-327-3	977C-1	777-1358-001	TEST ADAPTER	ASI DEALER
ASI-327-4	977D-1	777-1359-001	TEST ADAPTER	ASI DEALER
ASI-328	980H-1	522-4380-001	COUPLER TEST SET	ASI DEALER
ASI-328-1	878L-15	522-4252-001	ANTENNA COUPLER CONTROL TESTER	ASI DEALER
ASI-328-2	878L-16	522-4253-001	ELECTRONIC CONTROL AMPLIFIER TESTER	ASI DEALER
ASI-328-3	878L-17	522-4254-001	DISCRIMINATOR TESTER	ASI DEALER
ASI-328-4		761-4599-001	POWER PANEL	ASI DEALER
ASI-329-1	172H-8	522-4514-001	ANTENNA SIMULATOR, LONG WIRE (115 VAC 400 Hz)	ASI DEALER
ASI-329-1A	172H-8	522-4514-002	ANTENNA SIMULATOR, LONG WIRE (115 VAC 60 Hz)	ASI DEALER
ASI-329-1B	DA-487/U	522-4514-001	ANTENNA SIMULATOR, LONG WIRE (115 VAC 400 Hz)	ASI DEALER
ASI-329-1C	172H-8A	642-2190-001	ANTENNA SIMULATOR, LONG WIRE (MODIFIED FOR CU-2041/AR)	ASI DEALER
ASI-329-2	172H-1	522-1708-000	DUMMY COMPOSITE ANTENNA	ASI DEALER
ASI-329-3	172H-18A	622-7148-001	ANTENNA SIMULATOR, SHUNT (SEE ASI-207-1 FOR FUNCTIONAL EQUIVALENT)	ASI DEALER
ASI-329-3-220	172H-18A	622-7148-001	ANTENNA SIMULATOR, SHUNT-220 VAC (SEE ASI-207-1-220 FOR FUNCTIONAL EQUIV)	ASI DEALER
ASI-329-4	DA-174/GRM-10	522-1248-004	ELECTRICAL DUMMY LOAD	ASI DEALER
ASI-329-5	DA-175/GRM-10	522-1249-004	ELECTRICAL DUMMY LOAD	ASI DEALER
ASI-329-6	DA-173/GRM-10	522-1247-002	ELECTRICAL DUMMY LOAD (BIRD 694)	ASI DEALER
ASI-329-7	172H-21	622-1380-001	ANTENNA SIMULATOR, 16 FT WHIP (TIED DOWN)	ASI DEALER
ASI-329-8	172H-21A	622-1732-001	ANTENNA SIMULATOR, 16 FT WHIP (STRAIGHT UP)	ASI DEALER
ASI-329-8A	172H-21A	622-1732-002	ANTENNA SIMULATOR, 16 FT WHIP (STRAIGHT UP)	ASI DEALER
ASI-329-9	172H-17	777-1864-001	ELECTRICAL DUMMY LOAD	ASI DEALER

AVAILABILITY:

ASI DEALER: CONTACT ANY ASI DEALER FOR QUOTE
 COLLINS: CONTACT ROCKWELL COLLINS FOR QUOTE
 GABLES: CONTACT GABLES ENGINEERING FOR QUOTE
 TELEPHONICS: CONTACT TELEPHONICS FOR QUOTE

ASI SPECIALIZED TEST EQUIPMENT LIST

AVAILABILITY SUBJECT TO CHANGE WITHOUT NOTICE

<u>ASI MN</u>	<u>EQUIV MN</u>	<u>EQUIV PN</u>	<u>DESCRIPTION</u>	<u>AVAILABILITY</u>
ASI-329-10	172H-10	522-4601-001	ELECTRICAL DUMMY LOAD	ASI DEALER
ASI-329-11	172H-22	622-1381-001	ANTENNA SIMULATOR, 32 FT WHIP	ASI DEALER
ASI-329-12	172H-12	777-1455-001	SHUNT DUMMY ANTENNA	ASI DEALER
ASI-329-13	172H-26	622-5605-001	TAILCAP ANTENNA SIMULATOR (THIS WAS ORIGINALLY NUMBERED ASI-351)	ASI DEALER
ASI-329-14	172H-27	4S61700-101B	ANTENNA SIMULATOR FOR CU-2275(V)3	ASI DEALER
ASI-329-31		652-2416-001	TEST RF FEEDLINE FOR CU-2314(V)1/ARC-190(V)	ASI DEALER
ASI-329-32		651-3262-001	TEST RF FEEDLINE FOR CU-2314(V)2/ARC-190(V)	ASI DEALER
ASI-329-33		651-3244-001	TEST RF FEEDLINE FOR CU-2314(V)3/ARC-190(V)	ASI DEALER
ASI-329-34		652-2419-001	TEST RF FEEDLINE FOR CU-2314(V)4/ARC-190(V)	ASI DEALER
ASI-329-35		652-2441-001	TEST FIXTURE: 25-4000 pF VARIABLE CAPACITOR	ASI DEALER
ASI-329-36		652-2442-001	TEST FIXTURE: 0.1-5.0 mH VARIABLE COIL	ASI DEALER
ASI-329-141		652-2440-001	TEST RF FEEDLINE FOR CU-2275(V)3	ASI DEALER
ASI-329-301		751-0774-001	RF LOAD SWITCH FIXTURE	COLLINS
ASI-329-302		652-7708-001	RF LOAD SWITCH FIXTURE	COLLINS
ASI-330		638-0501-001	SPIN TABLE INTERLOCK	ASI DEALER
ASI-331			BREAKOUT BOX (DEHAVILLAND SPECIAL ORDER)	ASI DEALER
ASI-332	UG2559AB		RADAR ALTIMETER SYSTEM TESTER (TESTS YG-7500 / 7600)	ASI DEALER
ASI-333	UG2926AA		CALIBRATION UNIT PANEL (TESTS HG7502BC02/03/04)	ASI DEALER
ASI-334			HCP-74/74C TEST SET (MAN FIG 5-5 - 5-7)	ASI DEALER
ASI-335		949F859-1	GENERATOR TESTER	ASI DEALER
ASI-336		23-23-00-0054	SELCAL DECODER TESTER	ASI DEALER
ASI-337			KDI-573B TEST FIXTURE (REPLACED BY ASI-357-3)	OBSOLETE
ASI-338-1	CTS-200	622-4281-001	HF TEST INTERCONNECT TEST SET	ASI DEALER
ASI-338-2	CTS-201	622-4282-001	HF ANTENNA SIMULATOR (16FT)	ASI DEALER
ASI-338-3	CTS-202	622-4283-001	HF TEST SET (AAC/PWR/TCR)	ASI DEALER
ASI-338-4	CTS-203	622-4285-001	HF TEST SET (AAC-200 CKT CARD)	ASI DEALER
ASI-338-5	CTS-204	622-5403-001	HF TEST SET (HF-220)	ASI DEALER
ASI-338-6	PPF-200	622-3839-001	PROM FREQUENCY PROGRAMMER FOR HF-200/220	COLLINS
ASI-338-7		628-8554-001	DSA-220 TEST SET	ASI DEALER
ASI-338-8		628-8557-001	LWA-200 LONG WIRE ADAPTER TEST SET	ASI DEALER
ASI-339	980H-6	777-1534-001	ANTENNA COUPLER TEST SET	ASI DEALER
ASI-339-1	878L-19A	772-5291-001	DISCRIMINATOR TEST PANEL	ASI DEALER
ASI-339-2	878L-28	777-1856-001	ELECTRONIC CONTROL AMPLIFIER TEST PANEL	ASI DEALER
ASI-339-3	878L-29	777-1857-001	COUPLER CONTROL TEST PANEL	ASI DEALER
ASI-339-4	878L-30	777-1858-001	COUPLER CIRCUIT CARD TEST PANEL	ASI DEALER
ASI-339-5		792-0070-001	POWER PANEL	ASI DEALER
ASI-340-1	980H-2	522-4541-001	ANTENNA TESTER / SIMULATOR	ASI DEALER
ASI-340-2	890K-1	763-3346-001	ACCESSORY KIT	ASI DEALER
ASI-340-3	890K-2	772-5480-001	ACCESSORY KIT	ASI DEALER
ASI-340-4			TEST SET FOR ASI-340-1 OR 980H-2 (437R-1 / 980H-2 MAN FIG 7-5)	ASI DEALER
ASI-343			FD-112A/B/C/V TEST PANEL	ASI DEALER
ASI-344		647-9262-001	DAU-850 TEST ADAPTER (FOR CTS-2000)	ASI DEALER
ASI-345	578F-1	522-1977-000	334C-3() SERVO TEST PANEL (334C-3 MAN FIG 1003-1004)	ASI DEALER
ASI-346	980H-3	522-4748-001	ANTENNA COUPLER TEST SET	ASI DEALER
ASI-346-1	878L-1	522-3022-000	AMPLIFIER TEST PANEL	ASI DEALER
ASI-346-2	878L-2	522-3271-000	RELAY CONTROL TEST PANEL	ASI DEALER
ASI-346-3	878L-3	522-3272-000	DISCRIMINATOR TEST PANEL	ASI DEALER
ASI-346-4		772-6871-001	POWER PANEL	ASI DEALER
ASI-347			628T-2/2A A5 ALIGNMENT FIXTURE (MAN FIG 911) / REPLACED BY ASI-70-04P	ASI DEALER
ASI-348-1			SVO-65 OPTIONAL TEST PANEL (MAN FIG 5-10 - 5-11)	ASI DEALER
ASI-348-2			SVT-1000() ADAPTER PANEL	ASI DEALER
ASI-349-1	TR5289-1	2488-1/2482-1	AVTECH 5088-1/5289-1/5082-1 TEST PANEL (REPLACED BY ASI-349-10-/13-/15)	ASI DEALER
ASI-349-10		2482-1	AVTECH 5082-1-X PAA TEST SET	ASI DEALER
ASI-349-11		2483-1	AVTECH 5083-1 INTERPHONE TEST SET	ASI DEALER
ASI-349-12		2485-1	AVTECH 5082-50-X PCBA TEST SET	ASI DEALER
ASI-349-13		2488-1	AVTECH 5088-1-1 ICU TEST SET	ASI DEALER
ASI-349-14		2489-1	AVTECH 5089-1 ACU TEST SET	ASI DEALER
ASI-349-15		TR5289-1	AVTECH 5289-1 ACU TEST SET	ASI DEALER
ASI-349-2	TR5264-1		AVTECH 5264-1 TEST PANEL	ASI DEALER
ASI-349-3	TR5260-40-9	2361-1	AVTECH 5261-1 / 5260-1 STATION CARD TEST PANEL	ASI DEALER
ASI-349-4	TR5260-1		AVTECH 5260-1 TEST PANEL	ASI DEALER
ASI-349-5		2020-1	AVTECH TEST SET FOR 5141 / 5144 / 5145 CONTROL PANELS	ASI DEALER
ASI-349-50		2020-1-1	AVTECH 5145-1-XX SELCAL TESTER	ASI DEALER
ASI-349-51		2020-1-2	AVTECH 5145-1-XX SELCAL TESTER	ASI DEALER
ASI-349-6		05-44201	AVTECH 90-44201-2 FUNCTIONAL TEST BOX WTH CABLE (ASI-34-96A / 06-44201)	ASI DEALER
ASI-350-1		T321746	COMPARISON FLUX VALVE TEST FIXTURE	ASI DEALER
ASI-350-2			HELMHOLTZ COIL TEST STAND, DET TURNTABLE, MOUNTING BASE, VIBRATOR	ASI DEALER
ASI-351	172H-26	622-5605-001	TAILCAP ANTENNA SIMULATOR (THIS UNIT HAS BEEN RE-NUMBERED TO ASI-329-13)	ASI DEALER
ASI-352			MOTOR TESTER	ASI DEALER

AVAILABILITY:

ASI DEALER: CONTACT ANY ASI DEALER FOR QUOTE
 COLLINS: CONTACT ROCKWELL COLLINS FOR QUOTE
 GABLES: CONTACT GABLES ENGINEERING FOR QUOTE
 TELEPHONICS: CONTACT TELEPHONICS FOR QUOTE

ASI SPECIALIZED TEST EQUIPMENT LIST

AVAILABILITY SUBJECT TO CHANGE WITHOUT NOTICE

<u>ASI MN</u>	<u>EQUIV MN</u>	<u>EQUIV PN</u>	<u>DESCRIPTION</u>	<u>AVAILABILITY</u>
ASI-354		638-0239-001	AHC-85 DUAL MULTI SENSOR TEST PANEL	ASI DEALER
ASI-354-1	ASI-40Y-76-1		APC-65/FCC-65 SERVO EMULATOR	ASI DEALER
ASI-354-2	ASI-40Y-76-2		APC-65/FCC-65 SERVO ANGLE INDICATOR	ASI DEALER
ASI-355		638-0722-001	ANALOG BURN-IN INTERFACE PANNEL (VHF-21/22/422)	ASI DEALER
ASI-356-1		830-1212-001	CIU-906 TEST PANEL (REQUIRES ASI-356-2 FOR OPERATION)	ASI DEALER
ASI-356-2		830-3915-001	CIU-906 MOUNTING TRAY	ASI DEALER
ASI-357			TEST PANEL FOR KN-62/62A/63/64/KDM-706/KTU-709/KDI-572/573/574/KPI-553A	ASI DEALER
ASI-357-2			KPI-553 READOUT TEST PANEL	ASI DEALER
ASI-357-3			KDI-573B BENCH TESTER (MAN FIG 5-1, 5-2)	ASI DEALER
ASI-357-4			KDA-687 AUDIO ADAPTER TEST SET	ASI DEALER
ASI-358	969Y-1	622-5359-001	TEST PANEL FOR F-15 HSI / 331D-7 (622-0290-004)	ASI DEALER
ASI-359-1	TA-500	190-3006-01	TEST PANEL: 5ATI	HONEYWELL
ASI-360			RDR SYSTEM TEST PANEL	ASI DEALER
ASI-360-1		4000611-0000	RDR SYSTEM TEST PANEL	ASI DEALER
ASI-360-2		8090950-0001	NC-104 COMPOSITE TEST PANEL	TELEPHONICS
ASI-360-21		8091209-0001	TEST MODULE FOR NC-104	TELEPHONICS
ASI-360-3		4000601-0000	DA1203 ANTENNA TEST PANEL	ASI DEALER
ASI-360-4		4001740-0000	AN/APN-215 / DA-1203 ANTENNA RUN-IN TEST PANEL	ASI DEALER
ASI-360-5		4000614-0000	DA1203 ANTENNA RUN-IN TEST PANEL	TELEPHONICS
ASI-360-100A			RDR SYSTEM TEST RACK (INCLUDES RD-301A)	TELEPHONICS
ASI-360-100B			RDR SYSTEM TEST RACK (USER SUPPLIED RD-301A)	TELEPHONICS
ASI-361		696-4825-00	KVG-350 TEST PANEL (MAN FIG 5-2)	ASI DEALER
ASI-362		696-05641-0001	KAD-280 TEST SET (MAN FIG 5-1 - 5-3)	ASI DEALER
ASI-363			TDR-950/950L TEST PANEL WITH TEST COVER (MAN FIG 5-6, 5-7)	ASI DEALER
ASI-364		830-2513-002	STANDBY INDICATOR PS TEST FIXTURE (FPI-9330/9331)	ASI DEALER
ASI-365			RTA-8XX RECEIVER/IF TEST FIXTURE	ASI DEALER
ASI-365-1			TEST ADAPTER FOR RECEIVER ASSEMBLY 653-2349-001	ASI DEALER
ASI-365-2			SECOND IF TEST SET	ASI DEALER
ASI-366			642C-1/914F-1 TEST PANEL	ASI DEALER
ASI-367-1	878L-13	522-3971-001	RELAY CONTROL MODULE TEST PANEL	ASI DEALER
ASI-367-2	878L-18	522-4409-001	SERVO AMPLIFIER MODULE TEST PANEL	ASI DEALER
ASI-367-3	878L-19	522-4410-001	DISCRIMINATOR MODULE TEST PANEL	ASI DEALER
ASI-368			618M-2/3/4 TEST PANEL	ASI DEALER
ASI-369	F231-01		TEST FIXTURE FOR PACIFIC ELECTRO DYNAMICS 231-2	ASI DEALER
ASI-370		641-6468-001	ANT-462 T/L TEST PANEL	ASI DEALER
ASI-371			TURBULENCE ADAPTER	ASI DEALER
ASI-372			332E-5 GYRO TEST PANEL	ASI DEALER
ASI-373		638-0525-002	VHF-20/21/22/422 TEST PANEL	ASI DEALER
ASI-374-2			VHF-21/22/422 PS/MOD TEST FIXTURE (VCO MODULE NOT INCL)	ASI DEALER
ASI-375-1	970G-2	622-7345-001	ADF TEST PANEL	ASI DEALER
ASI-375-2	970G-2	622-7345-002	ADF TEST PANEL (WITH 1553 BUS ADAPTER)	ASI DEALER
ASI-376-1	966Y-2	622-6926-001	VOR/ILS TEST PANEL	ASI DEALER
ASI-376-2	966Y-2	622-6926-002	VOR/ILS TEST PANEL (WITH 1553 BUS ADAPTER)	ASI DEALER
ASI-376-3	966Y-2A	622-8325-001	VOR/ILS TEST PANEL (WITH AM-X ADAPTER)	ASI DEALER
ASI-376-4	966Y-2	622-6926-003	VOR/ILS TEST PANEL (WITH 1553 BUS ADAPTER AND AM-X ADAPTER)	ASI DEALER
ASI-376-5		676-6715-001	AM-X ADAPTER	ASI DEALER
ASI-377-1	978F-4A	522-3427-001	AMPLIFIER TEST PANEL FOR FD-108/109	ASI DEALER
ASI-377-2	978F-9A	522-4085-001	AMPLIFIER TEST ADAPTER PANEL FOR FD-109	ASI DEALER
ASI-377-3	978F-5R	522-3501-000	STEERING COMPUTER TEST PANEL FOR FD-109	ASI DEALER
ASI-377-4	978F-10R	522-4086-001	STEERING COMPUTER TEST ADAPTER FOR FD-109	ASI DEALER
ASI-377-5	978F-6P	522-3426-000	STEERING COMPUTER TEST PANEL FOR FD-109	ASI DEALER
ASI-377-6	978F-11P	522-4113-001	STEERING COMPUTER TEST ADAPTER FOR FD-109	ASI DEALER
ASI-377-7	978F-3M	522-3423-000	MODE CONTROL TEST PANEL FOR 614E- ()	ASI DEALER
ASI-377-8	978F-8W	522-3701-001	COMPARATOR WARNING MONITOR TEST PANEL	ASI DEALER
ASI-378-1			EXCITER ASSY TEST ADAPTER FOR 628-9744-002	ASI DEALER
ASI-378-2			EXCITER ASSY TEST ADAPTER FOR 628-9744-001	ASI DEALER
ASI-378-3			TURBULENCE TEST ADAPTER FOR DSP/CPU CARD 646-7991-011	ASI DEALER
ASI-378-4			TURBULENCE TEST ADAPTER FOR DSP/CPU CARD 646-7991-012	ASI DEALER
ASI-378-5			TURBULENCE TEST ADAPTER FOR DSP/CPU CARD 646-7991-003 THRU -010	ASI DEALER
ASI-378-6			RTA FLIGHT LINE TEST FIXTURE	ASI DEALER
ASI-378-7			WXP-840/850 FLIGHT LINE TEST FIXTURE	ASI DEALER
ASI-378-8		685-6238-001	WXP-840/850 TEST ADAPTER	ASI DEALER
ASI-378-9	850W	01-0131-00	FREQUENCY PLAN ADAPTER (USED WITH ASI-CTS-841)	ASI DEALER
ASI-379		628-8735-001	WXP TEST FIXTURE (WXP-4120/4220 MAN FIG 901)	ASI DEALER
ASI-380		1162291-100	DPCU UNIT TESTER	ASI DEALER
ASI-381	CTS-61	622-6317-001	AIR DATA SENSOR TEST SET	ASI DEALER
ASI-382		641-6388-900	VIR-32/432 INTERFACE PANEL	ASI DEALER
ASI-383			ATC-1400A/ARINC DME INTERROGATOR CTL UNIT (ATC-1400A MAN FIG 3)	ASI DEALER
ASI-384			RDMI-743/RMI-733 SLOW SLEW TESTER (REPLACED BY ASI-502 WITH ASI-502-0019)	ASI DEALER

AVAILABILITY:

ASI DEALER: CONTACT ANY ASI DEALER FOR QUOTE
 COLLINS: CONTACT ROCKWELL COLLINS FOR QUOTE
 GABLES: CONTACT GABLES ENGINEERING FOR QUOTE
 TELEPHONICS: CONTACT TELEPHONICS FOR QUOTE

ASI SPECIALIZED TEST EQUIPMENT LIST

AVAILABILITY SUBJECT TO CHANGE WITHOUT NOTICE

<u>ASI MN</u>	<u>EQUIV MN</u>	<u>EQUIV PN</u>	<u>DESCRIPTION</u>	<u>AVAILABILITY</u>
ASI-385			APR-4000 PWR SUPPLY TEST FIXTURE	ASI DEALER
ASI-386		641-5834-003	AHC-85 BURN-IN PANEL	ASI DEALER
ASI-387			CHP-85/86 TEST FIXTURE (CHP-85/86 MAN FIG 902-904)	ASI DEALER
ASI-388			FCC-85/86 TEST AID FIXTURE (FCC-85/86 MAN FIG 904)	ASI DEALER
ASI-389			FCC-85/86 SERVO PANEL (FCC-85/86 MAN FIG 905)	ASI DEALER
ASI-390			AHC-85 STRAPPING SWITCH ASSY (AHC-85 MAN FIG 904) / SEE ASI-433-5	ASI DEALER
ASI-391-1			AHC-85 INTEGRATION INTERFACE PANEL (AHC-85 MAN FIG 905) / SEE ASI-433-6	ASI DEALER
ASI-391-2			AHC-85 INTEGRATION CABLE ADAPTER (AHC-85 MAN FIG 906) / SEE ASI-433-7	ASI DEALER
ASI-392			MFD-85 DATA ANALYZER TEST SET (MFD-85 MAN FIG 903-905)	ASI DEALER
ASI-393-1			MFD-85 CRT LINEARITY GAUGE (MFD-85 MAN FIG 901)	ASI DEALER
ASI-393-2		634-1708-003	MFD-85() BEZEL ADAPTER (MFD-85 MAN FIG 902)	ASI DEALER
ASI-393-3		634-3819-001	EFD-85 CRT LINEARITY GAUGE (EFD-85 MAN FIG 901)	ASI DEALER
ASI-393-4		634-3820-001	EFD-86 CRT LINEARITY GAUGE (EFD-86 MAN FIG 902)	ASI DEALER
ASI-393-5		634-1708-001	EFD-85 BEZEL ADAPTER (EFD-85 MAN FIG 903)	ASI DEALER
ASI-393-6		634-1708-002	EFD-86 BEZEL ADAPTER (EFD-86 MAN FIG 904)	ASI DEALER
ASI-393-7		827-3807-001	EFD-84 LINEARITY GAUGE	ASI DEALER
ASI-393-8		827-2952-001	EFD-84 LINEARITY GAUGE	ASI DEALER
ASI-393-9		634-1708-010	EFD-84 BEZEL ADAPTER TEMPLATE	ASI DEALER
ASI-393-10		634-1708-011	EFD-84 BEZEL ADAPTER TEMPLATE	ASI DEALER
ASI-393-11		827-8244-002	PHOTOMETER ADAPTER	COLLINS
ASI-394			HPU-74 ANALOG MULTIPLEXER TEST FIXTURE (HPU-74 MAN FIG 5-3, 5-4)	ASI DEALER
ASI-395			CTS-74 TEST FIXTURE (CTS-74 MAN FIG 5-1, 5-2)	ASI DEALER
ASI-396			DCP-85 TEST BOX W/7 CABLES (DCP-85 MAN FIG 901-902)	ASI DEALER
ASI-397			TCN-40 (BRG-40/DME-40) TEST PANEL	ASI DEALER
ASI-399	7012-1403-900	T9-1-14-0039	DME 2-PULSE GENERATOR	ASI DEALER
ASI-400-1			ASI-2000 WORKSTATION (4 ASI-10-400X CABLES INCLUDED)	ASI DEALER
ASI-401-1			PRO LINE / PC INTERFACE PANEL WITH 7 CABLES FOR GENERAL INSTALLATION	ASI DEALER
ASI-401-1CTC			ASI-401-1 WITH CTC-429 CARD (SOFTWARE NOT INCLUDED)	ASI DEALER
ASI-401-2			PRO LINE / PC INTERFACE PANEL WITH CUSTOM CABLES FOR SPECIAL INSTAL.	ASI DEALER
ASI-401-2CTC			ASI-401-2 WITH CTC-429 CARD (SOFTWARE NOT INCLUDED)	ASI DEALER
ASI-401-3			PRO LINE / PC INTERFACE PANEL WITH 7 CABLES (6 FT) FOR GEN INSTALL	ASI DEALER
ASI-401-3CTC			ASI-401-3 WITH CTC-429 CARD (SOFTWARE NOT INCLUDED)	ASI DEALER
ASI-401-ISA			PRO LINE / PC INTERFACE CARD FOR ISA COMPUTER (SOFTWARE NOT INLCUDED)	ASI DEALER
ASI-402		638-0199-001	CTC-429 SERIAL LOOPBACK POD (CTC-429 MAN FIGURE 5-3)	ASI DEALER
ASI-403-1	972S-5	622-7122-001	SVO SERVO TEST PANEL FOR SVO-75/85	ASI DEALER
ASI-403-2	972S-5	622-7122-002	SVO SERVO TEST PANEL FOR SVO-1000	ASI DEALER
ASI-403-10		641-5133-001	SERVO TESTER, 425 IN-OZ (HD-700-6)	COLLINS
ASI-403-11		641-5133-009	SERVO TESTER, 50 IN-LB (HD-705-6)	COLLINS
ASI-404-1		676-3923-001	BCA SERVO TEST SET FOR BCA-770	ASI DEALER
ASI-405	969L-1	635-7420-001	914G-8/9/11 TEST PANEL	ASI DEALER
ASI-406			147B-2 TEST PANEL	ASI DEALER
ASI-407-1		T307702-4	POWER SUPPLY AND READOUT	ASI DEALER
ASI-407-2		T321272-901	API LATCHING FIXTURE	ASI DEALER
ASI-408		T322861	C-14D BASE TEST FIXTURE	ASI DEALER
ASI-409		T322780	C-14 AMPLIFIER/SYNCHRONIZER TEST FIXTURE	ASI DEALER
ASI-410		T307967	C-14 FLUX VALVE HEADING SIMULATOR	ASI DEALER
ASI-411-1		T322695	VG-401 TEST FIXTURE	ASI DEALER
ASI-411-2		T322880	TARSYN-H / VG-14H BASE TEST FIXTURE	ASI DEALER
ASI-412	CTS-64	622-6459-001	GYRO SYSTEM TEST PANEL	ASI DEALER
ASI-412-1		647-6750-001	TEST FIXTURE: BED OF NAILS (P/O ASI-412)	ASI DEALER
ASI-412-2			DGS-65 CUSTOMER ACCEPTANCE TEST SET (DGS-65 MAN FIG 5-13 - 5-15)	ASI DEALER
ASI-413-1	RIT-32A	2070809-3201	ILS RECEIVER TEST PANEL	ASI DEALER
ASI-413-2	RIG-32A	2070776-3201	ILS AUDIO GENERATOR	ASI DEALER
ASI-414			699Z-1 TEST FIXTURE (699Z-1 MAN FIG 2 IN MAINTENANCE SECTION)	ASI DEALER
ASI-415-1	970D-1A	622-5811-001	AIR DATA TEST PANEL WITH 6 EXTENDER CABLES	ASI DEALER
ASI-415-2	970D-1A	622-5811-002	AIR DATA TEST PANEL WITHOUT 6 EXTENDER CABLES	ASI DEALER
ASI-415-3	970D-3	622-5817-001	VERTICAL NAV TEST SET	ASI DEALER
ASI-416			DME-40/339F-12/IND-40 TEST FIXTURE (DME-40-339F-12/12() MANUAL FIGURE 5-6)	ASI DEALER
ASI-417-1	CTS-855	622-6457-011	ELECTRONIC FLIGHT DISPLAY SYSTEM TEST SET WITH 3 CABLES (REQUIRES ASI-418)	ASI DEALER
ASI-417-2	CTS-855	622-6457-012	ELECTRONIC FLIGHT DISPLAY SYSTEM TEST SET WITHOUT CABLES (REQ ASI-418)	ASI DEALER
ASI-418	CTS-858	622-7321-001	EFD/MFD GAIN POSITION CALIBRATOR TEST SET	ASI DEALER
ASI-419		641-5955-001	AHC-85 A7 TEST FIXTURE	ASI DEALER
ASI-420-1	RNT-34A	2041341-3401	RNA-34 ADAPTER PANEL	ASI DEALER
ASI-420-2	ADT-34AF	3614307-3401	RNA-34AF ADAPTER PANEL	ASI DEALER
ASI-422	CPT-83A	2041065-8301	GROUND PROXIMITY WARNING STSTEM TEST PANEL	ASI DEALER
ASI-423-1	IUT-1SB	3614367-0101	AUXILIARY INTERFACE UNIT TEST PANEL	ASI DEALER
ASI-423-2	IUT-1MB	3614662-0101	CONTROL TEST PANEL	ASI DEALER
ASI-424-1	RVT-33A	2070811-3301	VOR RECEIVER TEST PANEL	ASI DEALER
ASI-424-2	RVG-33A	2070810-3301	VOR AUDIO GENERATOR	ASI DEALER

AVAILABILITY:

ASI DEALER: CONTACT ANY ASI DEALER FOR QUOTE
 COLLINS: CONTACT ROCKWELL COLLINS FOR QUOTE
 GABLES: CONTACT GABLES ENGINEERING FOR QUOTE
 TELEPHONICS: CONTACT TELEPHONICS FOR QUOTE

ASI SPECIALIZED TEST EQUIPMENT LIST

AVAILABILITY SUBJECT TO CHANGE WITHOUT NOTICE

<u>ASI MN</u>	<u>EQUIV MN</u>	<u>EQUIV PN</u>	<u>DESCRIPTION</u>	<u>AVAILABILITY</u>
ASI-425	RTT-41A	2037676-0501	TRANSCIVER TEST PANEL FOR RTA-41A/42A/43A/83A, KTR-9100A	ASI DEALER
ASI-426	RCT-1500A	3614129-1501	RDR-1500 () RADAR SYSTEM TEST PANEL (W/10 CABLES)	TELEPHONICS
ASI-427	678Z-1	548-8001-005	FUNCTION TEST SET FOR 618T-1/2/3	ASI DEALER
ASI-428-1	002-0518-00	696-4096-00	TEST PANEL FOR KPI-552/552B AND KPI-553A/553B	ASI DEALER
ASI-428-2	050-1638-00	696-6257-00	TEST SET FOR KA-133 / KI-250 / KRA-10/10A	ASI DEALER
ASI-429-1			ADI-84 TEST ADAPTER PANEL W/2 CABLES	ASI DEALER
ASI-429-2			ADI-84 BREAKOUT BOX	ASI DEALER
ASI-430	967N-1	622-5379-001	ANTENNA COUPLER TEST SET	ASI DEALER
ASI-431	972S-4	622-3211-001	SERVO TEST SET FOR 334C-12H / SVO-830	ASI DEALER
ASI-432	CTS-88	622-6402-001	AHRS TET PANEL FOR AHC-85 / ICU-85	ASI DEALER
ASI-433-1			ICU-85 TEST FIXTURE (AHC-85 MAN FIG 102)	ASI DEALER
ASI-433-2			AHC-85 ZIF CLEANING TOOL (AHC-85 MAN FIG 901)	ASI DEALER
ASI-433-3		634-3018-001	TUMBLE FIXTURE (AHC-85 MAN FIG 902)	ASI DEALER
ASI-433-31		634-3018-002	TUMBLE FIXTURE FOR AHC-3000	ASI DEALER
ASI-433-4			RATE TABLE FIXTURE FOR AHC-85 MOUNT (AHC-85 MAN FIG 903)	ASI DEALER
ASI-433-5			STRAPPING SWITCH ASSY FOR AHC-85 (AHC-85 MAN FIG 904)	ASI DEALER
ASI-433-6			AHC-85 INTEGRATION INTERFACE PANEL AND CABLES (AHC-85 MAN FIG 905)	ASI DEALER
ASI-433-7			AHC-85 INTEGRATION CABLE ADAPTER (AHC-85 MAN FIG 906)	ASI DEALER
ASI-433-8			CTC-429 TO AHC-85 INTEGRATION CABLE (AHC-85 MAN FIG 907)	ASI DEALER
ASI-434-1	974W-1	797-0176-001	RADIO ALTIMETER TEST SET	ASI DEALER
ASI-434-11		797-0441-001	TEST SET (P/O ASI-434-1 / UNIT 1 OF 2)	ASI DEALER
ASI-434-12		797-0442-001	ACCESSORY KIT (P/O ASI-434-1 / UNIT 2 OF 2)	ASI DEALER
ASI-434-2	974W-1	797-0176-002	RADIO ALTIMETER TEST SET	ASI DEALER
ASI-434-21		797-0441-002	TEST SET (P/O ASI-434-2 / UNIT 1 OF 2)	ASI DEALER
ASI-434-22		797-0442-002	ACCESSORY KIT (P/O ASI-434-2 / UNIT 2 OF 2)	ASI DEALER
ASI-450		T307951	UNIVERSAL POINTER/FLAG TEST FIXTURE	ASI DEALER
ASI-451-1		T307962	UNIVERSAL INSTRUMENT SERVO TEST FIXTURE	ASI DEALER
ASI-451-2		T307962-425	FUNCTION TEST SET FOR C6	ASI DEALER
ASI-453		T307520-201	SERVO AMPLIFIER TEST FIXTURE WITH LRU CABLE	ASI DEALER
ASI-454-1		T307527-201	CONTROL PANEL TEST FIXTURE	ASI DEALER
ASI-454-2		T307527-202	CONTROL PANEL TEST FIXTURE	ASI DEALER
ASI-455		T307531-201	YAW SYNCHRONIZER TEST FIXTURE	ASI DEALER
ASI-456		T307533-201	AIR DATA SENSOR TEST FIXTURE	ASI DEALER
ASI-457		T307534-201	ALTITUDE SIGNAL COUPLER TEST FIXTURE	ASI DEALER
ASI-458-1		T307535-201	PITCH COMPUTER TEST FIXTURE	ASI DEALER
ASI-458-2		T307535-202	PITCH COMPUTER TEST FIXTURE	ASI DEALER
ASI-458-3		T307535-300	PITCH COMPUTER TEST ADAPTER	ASI DEALER
ASI-458-4		T307535-310	PITCH COMPUTER TEST ADAPTER	ASI DEALER
ASI-459-1		T307536-201	LATERAL PATH COUPLER TEST FIXTURE	ASI DEALER
ASI-459-2		T307536-202	LATERAL PATH COUPLER TEST FIXTURE	ASI DEALER
ASI-460-1		T307545-201	PITCH CONTROL CHANNEL TEST FIXTURE	ASI DEALER
ASI-460-2		T307545-202	PITCH CONTROL CHANNEL TEST FIXTURE	ASI DEALER
ASI-460-3		T307545-401	PITCH CONTROL CHANNEL ADAPTER	ASI DEALER
ASI-461-1		T307547-201	ROLL CONTROL CHANNEL TEST FIXTURE	ASI DEALER
ASI-461-2		T307547-202	ROLL CONTROL CHANNEL TEST FIXTURE	ASI DEALER
ASI-461-3		T307547-401	ROLL CONTROL CHANNEL ADAPTER	ASI DEALER
ASI-462		T307550-201	POSITION SENSOR TEST FIXTURE	ASI DEALER
ASI-463-1		T307554-201	YAW DAMPER COUPLER TEST FIXTURE	ASI DEALER
ASI-463-2		T307554-202	YAW DAMPER COUPLER TEST FIXTURE	ASI DEALER
ASI-463-3		T307554-401	YAW DAMPER COUPLER ADAPTER	ASI DEALER
ASI-464-1		T307555-201	TRIM COUPLER TEST FIXTURE	ASI DEALER
ASI-464-2		T307555-202	TRIM COUPLER TEST FIXTURE	ASI DEALER
ASI-465		T307563-201	HEADING SYNCHRONIZER TEST FIXTURE	ASI DEALER
ASI-466-1		T307571-201	VERTICAL PATH COUPLER TEST FIXTURE	ASI DEALER
ASI-466-2		T307571-202	VERTICAL PATH COUPLER TEST FIXTURE	ASI DEALER
ASI-467-1		T307573-201	ROLL COMPUTER TEST FIXTURE	ASI DEALER
ASI-467-2		T307573-202	ROLL COMPUTER TEST FIXTURE	ASI DEALER
ASI-467-102-002		467-102-002	CABLE: GTF-6 INPUT POWER (W1)	ASI DEALER
ASI-467-114-002		467-114-002	CABLE: GTF-6 TEST LEAD, RED (W2)	ASI DEALER
ASI-467-114-002-BK		467-114-002	CABLE: GTF-6 TEST LEAD, BLACK (W2)	ASI DEALER
ASI-467-118-002		467-118-002	CABLE: GTF-6 UNSH EXTENSION (W3)	ASI DEALER
ASI-467-137-001		467-137-001	CABLE: GTF-6 COAX (W4)	ASI DEALER
ASI-467-117-002		467-117-002	CABLE: GTF-6 COMP/COAX (W5)	ASI DEALER
ASI-467-138-001		467-138-001	CABLE: GTF-6 TEST LEAD (W6)	ASI DEALER
ASI-467-139-001		467-139-001	CABLE: GTF-6 TEST LEAD (W7)	ASI DEALER
ASI-467-147-001		467-147-001	CABLE: GTF-6 COAX (W8)	ASI DEALER
ASI-467-119-002		467-119-002	CABLE: GTF-6 COAX (W9)	ASI DEALER
ASI-468		T307574-201	Q SENSOR TEST FIXTURE	ASI DEALER
ASI-470		T307724-201	VERTICAL SPEED PITCH CONTROL TEST FIXTURE	ASI DEALER
ASI-471		T307846-902	VERTICAL GYRO TEST FIXTURE	ASI DEALER

AVAILABILITY:

ASI DEALER: CONTACT ANY ASI DEALER FOR QUOTE
 COLLINS: CONTACT ROCKWELL COLLINS FOR QUOTE
 GABLES: CONTACT GABLES ENGINEERING FOR QUOTE
 TELEPHONICS: CONTACT TELEPHONICS FOR QUOTE

ASI SPECIALIZED TEST EQUIPMENT LIST

AVAILABILITY SUBJECT TO CHANGE WITHOUT NOTICE

<u>ASI MN</u>	<u>EQUIV MN</u>	<u>EQUIV PN</u>	<u>DESCRIPTION</u>	<u>AVAILABILITY</u>
ASI-472		T307875	FAILURE WARNING MONITOR TEST FIXTURE	ASI DEALER
ASI-473		T307950	RATE OF TURN RACK TEST FIXTURE	ASI DEALER
ASI-474-1		T321019-201	CONTROL PANEL TEST FIXTURE	ASI DEALER
ASI-474-2		T321019-202	CONTROL PANEL TEST FIXTURE	ASI DEALER
ASI-474-3		T321019-301	TEST ADAPTER PANEL	ASI DEALER
ASI-474-4		T321019-401	TEST ADAPTER PANEL	ASI DEALER
ASI-474-5		T321019-404	TEST ADAPTER PANEL	ASI DEALER
ASI-474-6		T321019-405	TEST ADAPTER PANEL	ASI DEALER
ASI-475		T321116-201	PITCH CONTROL CHANNEL TEST FIXTURE	ASI DEALER
ASI-476		T321121-201	ROLL CONTROL CHANNEL TEST FIXTURE	ASI DEALER
ASI-477		T321241-201	MACH TRIM COUPLER TEST FIXTURE	ASI DEALER
ASI-478		T321352	AUTOMATIC STABILIZER TRIM UNIT TEST FIXTURE	ASI DEALER
ASI-479		T321356	VG-321 TEST FIXTURE SET (INCLUDES ASI-479-1/-2/-3)	ASI DEALER
ASI-479-1		T321356-1	UNIVERSAL COUNTER MODIFIED FOR USE WITH VG-321 TEST FIXTURE (P/O ASI-479)	ASI DEALER
ASI-479-2		T321356-2	VG-321 TEST FIXTURE (P/O ASI-479)	ASI DEALER
ASI-479-3		T321356-3	FREQ MONITOR PU CABLE FOR VG-321 TEST FIXTURE (P/O ASI-479) W5	ASI DEALER
ASI-480		T321372	MONITOR AND LOGIC UNIT TEST FIXTURE	ASI DEALER
ASI-481		T321670	CONTROLLER TEST FIXTURE WITH 10 CABLES	ASI DEALER
ASI-482		T321989	DIGITAL ALTIMETER TEST FIXTURE	ASI DEALER
ASI-483		T322029	RECEIVER TRANSMITTER TEST FIXTURE	ASI DEALER
ASI-484		T323177	TEST CABLE	ASI DEALER
ASI-485		T323206	DC-9/10 TRC POWER SUPPLY TEST FIXTURE	ASI DEALER
ASI-486		T323687-201	ROLL AUTOLAND TEST FIXTURE	ASI DEALER
ASI-487		T323689-201	PITCH AUTOLAND TEST FIXTURE	ASI DEALER
ASI-488	TS-488A/UP		ECHO BOX TEST PANEL (MODIFIED PER COLLINS WRT-701X FLW MANUAL)	ASI DEALER
ASI-489		T323689-202	PITCH AUTOLAND TEST FIXTURE	ASI DEALER
ASI-490		T325144	AUTOMATIC STABILIZER TRIM UNIT TEST FIXTURE ADAPTER	ASI DEALER
ASI-491		T307965	RATE OF TURN RACK MOUNTING FIXTURE	ASI DEALER
ASI-492-1		T322967	RADIO ALTIMETER TEST SET	ASI DEALER
ASI-492-2		T334109	RT-300 TEST FIXTURE ADAPTER	ASI DEALER
ASI-493		T321693	CS-412 COMPENSATOR TEST HARNESS	ASI DEALER
ASI-494			KRA-405 TEST SET (WITH 4 CABLES)	ASI DEALER
ASI-495			KRA-405B TEST SET	ASI DEALER
ASI-496			CCU-65/RCP-65 TEST FIXTURE (RCP-65/CCU-65 MAN FIG 5-3)	ASI DEALER
ASI-497-1	967M-1	622-5285-001	HARMONIC FILTER FOR 548S-()	ASI DEALER
ASI-497-2	967M-2	622-5286-001	AMPLIFIER TEST SET FOR 548S-()	ASI DEALER
ASI-497-3	967M-3	622-5287-001	POWER AMPLIFIER TEST SET FOR 548S-()	ASI DEALER
ASI-497-4	967M-4	622-5288-001	CONTROL CIRCUIT CARD TEST SET FOR 548S-() / AN/ARM-196	ASI DEALER
ASI-497-5	967M-5	622-5289-001	PREREGULATOR TEST SET FOR 548S-() / AN/ARM-197	ASI DEALER
ASI-498	699N-1	797-0299-001	980N-1 / ASI-203 / 80N-1A TEST ADAPTER (REPLACED BY ASI-203-TA)	NLA
ASI-499-1	476E-4	522-1487-004	HORIZONTAL SITUATION INDICATOR TEST SET	ASI DEALER
ASI-499-2	476E-4A	522-2698-004	HORIZONTAL SITUATION INDICATOR TEST SET	ASI DEALER
ASI-499-3	476E-4B	522-3049-004	HORIZONTAL SITUATION INDICATOR TEST SET	ASI DEALER
ASI-499-4	476E-4C	522-3547-000	HORIZONTAL SITUATION INDICATOR TEST SET	ASI DEALER
ASI-499-5	476E-1	522-1431-004	FLIGHT DIRECTOR COMPUTER TEST SET (REPLACED BY 476E-1A / ASI-499-6)	ASI DEALER
ASI-499-6	476E-1A	522-2848-004	FLIGHT DIRECTOR COMPUTER TEST SET	ASI DEALER
ASI-499-61			SPECIAL TEST FIXTURE FOR ASI-499-5/6 (479E-1/1A)	ASI DEALER
ASI-500-1			CONTROL HEAD SIMULATOR (ASI-10-500A CABLE INCLUDED)	ASI DEALER
ASI-500-1AC			CONTROL HEAD SIMULATOR WITH AC INVERTER (ASI-600-1)	ASI DEALER
ASI-500-2			ARINC 566A CONTROL HEAD SIMULATOR (1 ASI-10-500A CABLE INCLUDED)	ASI DEALER
ASI-500-2AC			ARINC 566A CONTROL HEAD SIMULATOR WITH AC INVERTER (ASI-600-1)	ASI DEALER
ASI-501-1			ARINC 566A TEST CTL HEAD (8.33 KHz CAPABILITY) FOR LINAIRE PANELS	ASI DEALER
ASI-501-2			ARINC 566A TEST CTL HEAD (8.33 KHz CAPABILITY)	ASI DEALER
ASI-501-3			ARINC 566A COM TEST CTL HEAD (8.33 KHz CAPABILITY) 313N-2/3 CONNECTOR	ASI DEALER
ASI-501-4			NAV TEST CTL HEAD (REPLACES 313N-2/3 NAV)	ASI DEALER
ASI-501-5			ADF TEST CTL HEAD SIMULATOR (REPLACES 614L-11/12/13 FOR ADF TESTING)	ASI DEALER
ASI-502			CONTROL WIZARD / CONTROL HEAD SIMULATOR / DATA BUS ANALYZER	ASI DEALER
ASI-502-022			OPTIONAL PROGRAM, CTL-230 W/ ADAPTER BOARD	ASI DEALER
ASI-503-1			BREAKOUT BOX FOR DSUB 9/15/25/37/50 CONNECTORS (REPLACES ASI-503)	ASI DEALER
ASI-504			APP-80 LOGIC MONITOR (PER FCS-80 SIL 1-82)	ASI DEALER
ASI-600-1			400 CYCLE INVERTER (MOUNTS IN ASI-500-1)	ASI DEALER
ASI-601-1	966D-17A	622-9069-001	FAULT MONITOR TEST SET	ASI DEALER
ASI-602-1	966D-18	622-7340-001	SELSCAN INTERFACE TEST PANEL WITH TEST ADAPTER (AS-603-1 / 964B-1)	ASI DEALER
ASI-602-2	966D-18	622-7340-002	SELSCAN INTERFACE TEST PANEL WITH TEST ADAPTER (AS-603-2 / 964B-2)	ASI DEALER
ASI-602-3	966D-18	622-7340-003	SELSCAN INTERFACE TEST PANEL WITH TEST ADAPTER (AS-603-3 / 964B-3)	ASI DEALER
ASI-603-1	964B-1	622-8665-001	DUAL SYSTEM RS232 TEST ADAPTER	ASI DEALER
ASI-603-2	964B-2	822-0735-001	1553/RS232 TEST ADAPTER	ASI DEALER
ASI-603-3	964B-3	822-1408-001	RS422 TEST ADAPTER	ASI DEALER
ASI-603-4	964B-4	822-1728-001	TALKOUT TEST ADAPTER	COLLINS

AVAILABILITY:

ASI DEALER: CONTACT ANY ASI DEALER FOR QUOTE
 COLLINS: CONTACT ROCKWELL COLLINS FOR QUOTE
 GABLES: CONTACT GABLES ENGINEERING FOR QUOTE
 TELEPHONICS: CONTACT TELEPHONICS FOR QUOTE

ASI SPECIALIZED TEST EQUIPMENT LIST

AVAILABILITY SUBJECT TO CHANGE WITHOUT NOTICE

ASI MN	EQUIV MN	EQUIV PN	DESCRIPTION	AVAILABILITY
ASI-604-1		263TS101-1	BATTERY CHARGER TEST SET FOR ACME 263BC101-2/3	ASI DEALER
ASI-604-2			BATTERY CHARGER TEST SET FOR CRANE 8-930-3 / S282T003-3	ASI DEALER
ASI-605-1	998U-1	622-5691-001	COUPLER TEST SET	ASI DEALER
ASI-605-2	998U-1	622-5691-002	COUPLER TEST SET	ASI DEALER
ASI-605-3	998U-1A	622-7694-001	COUPLER TEST SET	ASI DEALER
ASI-605-4	998U-1A	622-7694-002	COUPLER TEST SET	ASI DEALER
ASI-606			RESERVED	
ASI-607			RESERVED	
ASI-608	967A-1	622-4805-001	INTERFACE TEST SET	ASI DEALER
ASI-609	RT-909		BATTERY POWER SUPPLY TEST SET FOR RPS1-B	ASI DEALER
ASI-610	972Q-4	622-2211-002	VOR/ILS/MB RAMP TEST SET	ASI DEALER
ASI-700-1			INDICATOR DISCRETE FUNCTION INTERFACE UNIT	ASI DEALER
ASI-700-2			ADF/GLU/ILS/VOR DISCRETE FUNCTION INTERFACE UNIT	ASI DEALER
ASI-700-2-1			GLU-RF ADAPTER PANEL	ASI DEALER
ASI-700-3			DME/LRA DISCRETE FUNCTION INTERFACE UNIT	ASI DEALER
ASI-700-4			VHF/HF DISCRETE FUNCTION INTERFACE UNIT	ASI DEALER
ASI-700-4-01		983-4904-001	OSCILLOSCOPE LOGIC PROBE	ASI DEALER
ASI-700-4-02		983-4924-001	POWER SUPPLY LOAD TEST FIXTURE	ASI DEALER
ASI-700-4-03		830-7415-101	TRANSLATOR TESTER	ASI DEALER
ASI-700-4-04		830-7934-001	BLOWER A4A2 TEST FIXTURE	ASI DEALER
ASI-700-4-05		647-2143-001	CHASSIS / POWER SUPPLY TEST FIXTURE	ASI DEALER
ASI-700-4-06			UNITY GAIN AMPLIFIER CIRCUIT	ASI DEALER
ASI-700-4-07			VOLTAGE REGULATOR A6A3 TESTER FOR HFS-900D	ASI DEALER
ASI-700-4-08		830-7754-001	CONTROL BOX ASSEMBLY-BANDSWITCH ADAPTER FOR HFS-700/900	ASI DEALER
ASI-700-4-09	HFDL-753	01-0992-00	ARINC-753 HFDL VOICE INTERFACE PANEL	ASI DEALER
ASI-701		652-9764-001	EDU-HIGH VOLTAGE POWER SUPPLY TEST PANEL	ASI DEALER
ASI-701-1C		647-8076-004	CABLE: ASI-701 SUPPLY INTERFACE	ASI DEALER
ASI-702			DEM TESTER (RDMI-743A MAN. FIG. 915 - 917)	ASI DEALER
ASI-703			CALIBRATION FIXTURE (RDMI-743A MAN. FIG 909)	ASI DEALER
ASI-704			POWER SUPPLY TESTER (RDMI-743A MAN. FIG. 911 - 914)	ASI DEALER
ASI-705		647-8773-001	POWER SUPPLY FIXTURE (EAP-701() MAN. FIG. 903 - 904)	ASI DEALER
ASI-706	MST-904	622-6103-001	MICROPROCESSOR SYSTEM TEST SET ADAPTER	ASI DEALER
ASI-707A			DME-700/900 DRIVER A4 ALIGNMENT COVER (DME-700 MAN. FIG 903)	ASI DEALER
ASI-707B			DME-700/900 SYNTH A3 ALIGNMENT COVER (DME-700 MAN. FIG 904)	ASI DEALER
ASI-707C			DME-700/900 PWR AMP ALIGNMENT COVER (DME-700 MAN. FIG 905)	ASI DEALER
ASI-708			SUPPRESSOR LOAD BOX (TPR-710A MAN. FIG. 903)	ASI DEALER
ASI-708-1	KTS-157	071-5040-00	HF/SSB TEST SET	ASI DEALER
ASI-709			RECEIVER EXTENDER CABLE (TPR-710A MAN. FIG. 904)	ASI DEALER
ASI-710			COAX EXTENDER CABLE (TPR-710A MAN. FIG 906)	ASI DEALER
ASI-711			500-OHM T-ATTENUATOR (HFS-700 MAN. FIG. 904)	ASI DEALER
ASI-712			RF INJECTION PROBE, 50-OHM (HFS-700 MAN. FIG. 902)	ASI DEALER
ASI-713	MST-903	622-6102-001	MICROPROCESSOR SYSTEM TEST SET ADAPTER	ASI DEALER
ASI-714		827-0200-003	IDENT SIGNAL GENERATOR (REPLACED ASI-714-2)	ASI DEALER
ASI-714-2		827-0200-003	IDENT SIGNAL GENERATOR	ASI DEALER
ASI-715-1			TUNING COVER (ILS-700 MAN. FIG 906)	ASI DEALER
ASI-715-2		628-8364-001	TEST COVER (ILS-700 MAN FIG 907)	ASI DEALER
ASI-716	MST-905	622-6104-001	MICROPROCESSOR SYSTEM TEST SET ADAPTER	ASI DEALER
ASI-717			ALTITUDE SIMULATION FIXTURE (LRA-700 MAN. FIG. 906 - 907)	ASI DEALER
ASI-718			RF TUNING COVER (LRA-700 MAN. FIG 904-905)	ASI DEALER
ASI-718U-5			781U-5 SYSTEM TEST SET (REQUIRES INTERPOLATION OF TEST PROCEDURES)	ASI DEALER
ASI-719			PULSE GENERATOR TEST BOX (LRA-700 MAN. FIG. 906 - 907)	ASI DEALER
ASI-720			ATTENUATOR 26 dB L-PAD (PAU-700 MAN. FIG. 901A)	ASI DEALER
ASI-721		099-4386-000	PAU-700 TEST FIXTURE (PAU-700 MAN. FIG 902 - 904)	ASI DEALER
ASI-722	WMT-701X	646-4443-009	WXR-700 RADAR TEST TRAY	ASI DEALER
ASI-722-1			WXR-700 COOLING MOUNT (CAN BE USED IN PLACE OF ASI-722)	ASI DEALER
ASI-722-1-220			WXR-700 COOLING MOUNT (CAN BE USED IN PLACE OF ASI-722) / 220 VAC	ASI DEALER
ASI-722-2		2039960-0501	RTA-4A COOLING MOUNT	ASI DEALER
ASI-722-2-220		2039960-0501	RTA-4A COOLING MOUNT (220 VAC)	ASI DEALER
ASI-722-3		2039960-050	COOLING UNIT	ASI DEALER
ASI-722-3-220		2039960-050	COOLING UNIT (220 VAC)	ASI DEALER
ASI-722-10		131-3606-179	WAVEGUIDE SWITCH TESTER FOR WMT-701X	ASI DEALER
ASI-723	MST-902	622-6101-001	MICROPROCESSOR SYSTEM TEST SET ADAPTER	ASI DEALER
ASI-724			TEST BREAKOUT PANEL (WXR-700X MAN. FIG. 508 - 509)	ASI DEALER
ASI-725			LEVELING BASE (WMA-701X/702X AND WFA-701X MAN. FIG. 902)	ASI DEALER
ASI-726		647-1997-001	MOTOR DRIVER TEST FIXTURE (WMA-701X/702X MAN. FIG. 906A)	ASI DEALER
ASI-727			FRONT PANEL EXTENDER CABLE (WXI-711 MAN. FIG. 903)	ASI DEALER
ASI-728			ANTENNA WEIGHT SIMULATOR (WMA-701X/702X MAN. FIG. 903)	ASI DEALER
ASI-729		647-0283-001	POWER SUPPLY TEST FIXTURE (WMA-701X/702X MAN. FIG. 905 - 906)	ASI DEALER
ASI-730-1			REAR CONNECTOR BREAKOUT BOX (WXI-711 MAN. FIG. 906)	ASI DEALER

AVAILABILITY:

ASI DEALER: CONTACT ANY ASI DEALER FOR QUOTE
 COLLINS: CONTACT ROCKWELL COLLINS FOR QUOTE
 GABLES: CONTACT GABLES ENGINEERING FOR QUOTE
 TELEPHONICS: CONTACT TELEPHONICS FOR QUOTE

ASI SPECIALIZED TEST EQUIPMENT LIST

AVAILABILITY SUBJECT TO CHANGE WITHOUT NOTICE

<u>ASI MN</u>	<u>EQUIV MN</u>	<u>EQUIV PN</u>	<u>DESCRIPTION</u>	<u>AVAILABILITY</u>
ASI-730-2			TCAS REAR CONNECTOR BREAKOUT BOX (WXI-711 MAN. FIG. 904-905)	ASI DEALER
ASI-731			MOTOR DRIVER TEST FIXTURE (WMA-701X/702X MAN. FIG. 907 - 909)	ASI DEALER
ASI-732			RCVR/MONITOR DRIVER TEST FIXTURE (WMA-701X/702X MAN. FIG. 909A-C)	ASI DEALER
ASI-733			PRELOAD SPRING TORQUE ADAPTER (WMA-701X/702X MAN. FIG. 910)	ASI DEALER
ASI-734			ZERO MONITORS A5 AND A6 MOUNTING JIG (WMA-701X/702X MAN. FIG. 911)	ASI DEALER
ASI-735			ZERO MONITORS A5 AND A6 MOUNT PROBE (WMA-701X/702X MAN. FIG. 912)	ASI DEALER
ASI-736			COIL SPRING TORQUE ADAPTER (WMA-701X/702X MAN. FIG. 913)	ASI DEALER
ASI-737			X BAND WAVEGUIDE FLANGE (WMA-701X/702X MAN. FIG. 914)	ASI DEALER
ASI-737-2			C BAND WAVEGUIDE FLANGE (WMA-701C/702C MAN. FIG. 914)	ASI DEALER
ASI-738	WJB-701	622-5760-001	J-BOX (WXR-700X MAN. FIG. 505 - 507)	ASI DEALER
ASI-739			TURBULENCE TESTER FOR WRT-701X	ASI DEALER
ASI-740		647-8028-001	EFIS LOW VOLTAGE POWER SUPPLY TEST PANEL	ASI DEALER
ASI-741	RMT-4A	8055325-0401	DOPPLER SIGNAL GENERATOR	ASI DEALER
ASI-742	RCT-4A	2041589-0401	RADAR SYSTEM TEST PANEL	ASI DEALER
ASI-743	AIT-4A	8074503-0401	TCAS PPT ADAPTER TEST PANEL	ASI DEALER
ASI-744			DSP-7000 STANDARD TEST PANEL	ASI DEALER
ASI-745-1		830-3834-001	DLM-900 POWER SUPPLY TEST FIXTURE	ASI DEALER
ASI-745-2		830-3834-002	TTR-920 POWER SUPPLY TEST PANEL (CALL FOR AVAILABILITY)	COLLINS
ASI-745-3		830-3834-003	SDU-906 POWER SUPPLY TEST FIXTURE	ASI DEALER
ASI-746-1		676-7387-003	DLM-900 RAM BUFFER CARD	ASI DEALER
ASI-746-2		676-7387-003	SDU-906 RAM BUFFER CARD	ASI DEALER
ASI-747		676-7385-001	BUS BUFFER CARD	ASI DEALER
ASI-748		830-4928-001	DLM-900 LOOPBACK POD	ASI DEALER
ASI-749		830-1228-001	SDU-906 SYSTEM PROCESSOR TEST SET	ASI DEALER
ASI-750		830-1243-001	SDU-906 VCO TEST FIXTURE	ASI DEALER
ASI-751		830-1630-001	SDU-906 MAIN UNIT TEST SET	ASI DEALER
ASI-752		830-1631-001	SDU-906 VCO TEST SET	ASI DEALER
ASI-753		830-1635-001	SDU-906 IF/SYNTHESIZER TEST SET	ASI DEALER
ASI-754		830-1638-001	SDU-906 CHANNEL MODULE ADAPTER	ASI DEALER
ASI-755		830-1639-001	SDU-906 CEPT ADAPTER TEST FIXTURE	ASI DEALER
ASI-756		830-1640-001	SDU-906 429 ADAPTER TEST MODULE	ASI DEALER
ASI-757		830-1641-001	SDU-906 REAR AUXILIARY TEST SET	ASI DEALER
ASI-758-1	TEE-5	822-1051-001	AAMP5 WITH 512K HISTORY	ASI DEALER
ASI-758-2	TEE-5	822-1051-002	AAMP5 WITH 128K HISTORY	ASI DEALER
ASI-758-3	TEE-5	822-1051-003	AAMP2/2-8/3 WITH 512K HISTORY	ASI DEALER
ASI-758-4	TEE-5	822-1051-004	AAMP2/2-8/3 WITH 128K HISTORY	ASI DEALER
ASI-759		828-0281-001	DLM-900 I/O EXTENDER CARD	ASI DEALER
ASI-760	PPT-4A	2041591-0401	RADAR INDICATOR TEST PANEL	ASI DEALER
ASI-761			BURN-IN RACK FOR GLU-920	ASI DEALER
ASI-762		830-6309-001	CIU-906 TEST PANEL	ASI DEALER
ASI-763-1		830-3359-005	WMA-701/702X ELEVATION DRIVE GEAR SHIMMING FIXTURE (MAN FIG 920)	ASI DEALER
ASI-763-2		830-3359-004	WMA-701/702X SCAN DRIVE GEAR SHIMMING FIXTURE (MAN FIG 921)	ASI DEALER
ASI-764			WCP-701/702 TEST FIXTURE	ASI DEALER
ASI-765		099-4421-000	CMU-900 POWER SUPPLY TEST SET	ASI DEALER
ASI-766		830-8625-001	CMU-900 TEST PANEL	ASI DEALER
ASI-767			CMU-900 JTAG ASSY (CMU-900 MAN FIG 907)	ASI DEALER
ASI-768			DCU-2000 TEST SET (DCU-200 MAN FIG 901)	ASI DEALER
ASI-769			DSP-2000 TEST ADAPTER	ASI DEALER
ASI-770	AST-4A	2041886-0401	RADAR ANTENNA SIMULATOR PANEL	ASI DEALER
ASI-771	ATT-4A	2041592-0401	RADAR ANTENNA TEST PANEL	ASI DEALER
ASI-772	KTS-152	071-5026-00	KG-102/102A/105 GYRO TEST PANEL	ASI DEALER
ASI-773	KTS-153	071-5027-00	KI-525/525A TEST PANEL	ASI DEALER
ASI-774-1			DFIU / DFP-702/703/712/712A/713/713A	ASI DEALER
ASI-775		830-8075-001	UNIVERSAL POWER SUPPLY TEST PANEL	ASI DEALER
ASI-776-1		002-00608-0000	KDM-7060 DME BENCH TEST SET	ASI DEALER
ASI-776-2		002-0609-00	KDM-706A OPTIONAL BENCH TEST SET	ASI DEALER
ASI-776-3		002-00615-0000	KDM-7070 DME BENCH TEST SET	ASI DEALER
ASI-776-4			KDM-7000 / KDM-7000A KDM-700B DME TEST PANEL	ASI DEALER
ASI-777	TE-9210	822-1429-001	HF-9000 SYSTEM TEST SET (INCLUDES FUNCTIONS OF THE TE-9200 AND TE-9600)	ASI DEALER
ASI-777-2	TE-9200	622-9418-001	HF-9000 SYSTEM TEST SET	ASI DEALER
ASI-777-3	TE-9300	622-9419-001	HF-9000 PROCESSOR TEST SET	ASI DEALER
ASI-777-4	TE-9500	822-0092-001	HF-9000 RF TUNER TEST SET	ASI DEALER
ASI-777-5	TE-9600	822-0880-001	HF-9000 ARINC TEST SET	ASI DEALER
ASI-777-6		685-1179-001	HF-9000 LOWPASS FILTER TEST FIXTURE	ASI DEALER
ASI-777-61		987-0007-767	HF-9000 LOWPASS FILTER TEST FIXTURE	ASI DEALER
ASI-777-7		987-0018-001	HF-9087D AUDIO I/O TEST FIXTURE	ASI DEALER
ASI-777-71		987-0007-768	HF-9087F AUDIO I/O TEST FIXTURE	ASI DEALER
ASI-777-8		685-1807-001	HF-9000 POWER AMPLIFIER TEST PANEL	ASI DEALER
ASI-777-81		987-0007-786	HF-9000 POWER AMPLIFIER TEST PANEL	ASI DEALER

AVAILABILITY:

ASI DEALER: CONTACT ANY ASI DEALER FOR QUOTE
 COLLINS: CONTACT ROCKWELL COLLINS FOR QUOTE
 GABLES: CONTACT GABLES ENGINEERING FOR QUOTE
 TELEPHONICS: CONTACT TELEPHONICS FOR QUOTE

ASI SPECIALIZED TEST EQUIPMENT LIST

AVAILABILITY SUBJECT TO CHANGE WITHOUT NOTICE

<u>ASI MN</u>	<u>EQUIV MN</u>	<u>EQUIV PN</u>	<u>DESCRIPTION</u>	<u>AVAILABILITY</u>
ASI-777-82		987-0007-787	HF-9000 BLOWER FIXTURE	ASI DEALER
ASI-777-91		752-5809-001	HF-9000 RF SWITCH BOX (SEE ASI-77-7H FOR ALTERNATE VERSION)	COLLINS
ASI-777-92		647-7742-001	HF-9000 RF SWITCH BOX	COLLINS
ASI-777-10			HF-9000 SYSTEM HARNESS	ASI DEALER
ASI-778	TE-9400	622-9420-001	HF-9000 EXTENDER SET	ASI DEALER
ASI-779-1			M-4C FLIGHT CONTROL SYSTEM TEST PANEL (INCLUDES ASI-779-1)	ASI DEALER
ASI-779-2			M-4D TEST ADAPTER	ASI DEALER
ASI-779-3			FLIGHT SYSTEM CONTROL SIMULATOR (P/O ASI-779-1)	ASI DEALER
ASI-780-1	TS-810A	4000385-1002	FCS-810 FLIGHT CONTROL SYSTEM TEST PANEL	ASI DEALER
ASI-780-2	TA-810A	4000866-1001	TEST ADAPTER (INCLUDED WITH ASI-780-1)	ASI DEALER
ASI-780-3	TS-870A	4001357-7001	FCS-870 FLIGHT CONTROL SYSTEM TEST PANEL	ASI DEALER
ASI-781			KLN-900 TEST PANEL (KLN-900 MAN FIG 902) (INCLUDES ASI-140 AND ASI-150)	ASI DEALER
ASI-782			KFS-599A/B TEST PANEL (KFS-599B MAN FIG 9001-9002)	ASI DEALER
ASI-783			RDR-2000/2100 (ART-2000 / ART-2100 / IND-182A) TEST SET	ASI DEALER
ASI-784		071-00168-0000	BREAKOUT / TEST PANEL FOR KMD-540	ASI DEALER
ASI-785			TEST PANEL FOR KLN-35A/89/90A/90B/94	ASI DEALER
ASI-786			RDS-81/82/84/86 SYSTEM TEST SET (REQUIRES ASI-78-6x CABLES)	ASI DEALER
ASI-789	AN/ARM-102	522-4545-001	TEST SET, ARA-50 DIRECTION FINDER GROUP (W/4 CABLES)	ASI DEALER
ASI-789-1	TS-2544	522-4817-001	TEST SET (P/O ASI-789)	ASI DEALER
ASI-789-2	MT-3726	522-4818-001	TEST MOUNT (P/O ASI-789)	ASI DEALER
ASI-789-3		622-2182-001	TEST ADAPTER, AN/ARM-102 OR ASI-789 TO DF-301E	ASI DEALER
ASI-790	970V-1	622-3029-001	DIRECTION FINDER TEST SET FOR DF-301E	ASI DEALER
ASI-791		002-00566-0000	KNR-634/634A TEST PANEL (KN4-634A MAN FIG 5-1)	ASI DEALER
ASI-792	KTS-192		PROBE/ANTENNA COUPLER TESTER FOR KAC-992 (INCL ASI-792-1 AND ASI-792-2)	ASI DEALER
ASI-792-1		071-5079-00	BENCH TEST SET (P/O ASI-792)	ASI DEALER
ASI-792-2		071-5080-00	ANTENNA LOAD BOX (P/O ASI-792)	ASI DEALER
ASI-793		155-1442-00	KHF990 (KAC-992/KTR-993/KFS-594) SYSTEM TEST HARNESS	ASI DEALER
ASI-793-1			KHF1050 (KAC-1052/KPA-1052/KRX-1053/PS-440) SYSTEM BENCH-TEST HARNESS	ASI DEALER
ASI-794		002-00544-0000	KX-155/165 SYSTEM BENCH TEST SET	ASI DEALER
ASI-795			KMA-24/24H TEST SET	ASI DEALER
ASI-796-1		UG2293AA01	TOTALIZING INDICATOR TEST SET	ASI DEALER
ASI-796-2		UG2293AA02	TOTALIZING INDICATOR TEST SET	ASI DEALER
ASI-797-1			KY-196A/197A BENCH TEST SET (KY-196A/197A MAN FIG 1005)	ASI DEALER
ASI-797-2			KT-71 TEST SET (KT-71 MAN FIG 5-1)	ASI DEALER
ASI-798	KTS-156	071-5038-00	ADF ANTENNA SUMILATOR TEST SET (INCLUDES ASI-798-1 AND ASI-798-2)	ASI DEALER
ASI-798-1	KTA-156	200-6448-01	TEST ADAPTER	ASI DEALER
ASI-798-2		200-2748-01	ANTENNA AMP MODULE	ASI DEALER
ASI-799	AXT-4A	8055692-0401	FAULT DATA TEST UNIT	ASI DEALER
ASI-801	DMT-37A	2041594-3701	DME TEST PANEL	ASI DEALER
ASI-802	ALT-52A	2041475-5201	RADIO ALTIMETER TEST PANEL	ASI DEALER
ASI-803	RTT-44A	2041524-4401	VHF COMM TEST PANEL	ASI DEALER
ASI-803-1		303-0005-001	2X5 TUNING PANEL FOR RTA-83A	ASI DEALER
ASI-804	DFT-75A	2041520-7501	ADF TEST PANEL	ASI DEALER
ASI-804-1	DFT-75B	2041597-7501	ADF ANTENNA TEST SET	ASI DEALER
ASI-804-2		2040156-0501	ADF ANTENNA HOLDER FIXTURE	ASI DEALER
ASI-804-3			SIMULATOR TEST SET (INCLUDES ADAPTER CABLES FOR -7504 AND ABOVE)	ASI DEALER
ASI-805	RNT-30A	2041634-3003	NAV TEST PANEL (INCLUDES RIA-35A/35B AND RVA-36A CABLE)	ASI DEALER
ASI-805-1	RNT-30A	2041634-3001	NAV TEST PANEL (INCLUDES RIA-35A/35B CABLE)	ASI DEALER
ASI-805-2	RNT-30A	2041634-3002	NAV TEST PANEL (INCLUDES RVA-36A CABLE)	ASI DEALER
ASI-810	92N-2	01-0215-00	SERIES III TEST SYSTEM (INCLUDES ASI-810-1, ASI-810-2, AND ASI-810-3)	ASI DEALER
ASI-810-1	92AF-1	01-0216-00	SERIES III ADF TEST PANEL FOR DFS-43 SYSTEM	ASI DEALER
ASI-810-2	92CN-1	01-0217-00	SERIES III VHF/NAV TEST PANEL FOR VCS-40 / VNS-41 SYSTEMS	ASI DEALER
ASI-810-3	92XD-1	01-0218-00	SERIES III DME/XPDR TEST PANEL FOR DMS-44 / TRS-42 SYSTEMS	ASI DEALER
ASI-810-4			TEST PANEL FOR CD-671C	ASI DEALER
ASI-811-1		226-40-1	TEST SET FOR 226-1 (AIRSHOW / CABIN SYSTEMS)	ASI DEALER
ASI-811-2		828-40-1	TEST SET FOR 828-1 (AIRSHOW / CABIN SYSTEMS)	COLLINS
ASI-811-3		902-40-1	TEST SET FOR 902-1 (AIRSHOW / CABIN SYSTEMS)	COLLINS
ASI-811-4		1165-40-1	TEST SET FOR 1165-1 (AIRSHOW / CABIN SYSTEMS)	ASI DEALER
ASI-811-5		1226-40-1	TEST SET FOR 1226-1 (AIRSHOW / CABIN SYSTEMS)	ASI DEALER
ASI-811-6		1287-40-1	TEST SET FOR 1287-1 (AIRSHOW / CABIN SYSTEMS)	ASI DEALER
ASI-811-7		1730-40-1	TEST SET FOR 1730-1 (AIRSHOW / CABIN SYSTEMS)	COLLINS
ASI-811-8		807-40-1	TEST SET	COLLINS
ASI-812-1			BREAKOUT BOX FOR TAILWIND SSP/GEM/FMU (INCLUDES 4 CABLES)	COLLINS
ASI-812-2			ADAPTER CABLE KIT FOR TAILWIND SSP/GEM/FMU BREAKOUT BOX (3 CABLES)	COLLINS
ASI-813			VMOD TEST SET	COLLINS
ASI-814			10.4" MONITOR RETRACT POWER SUPPLY (442-0679-001) TEST SET	COLLINS
ASI-815			MCU BOARD TEST FIXTURE	COLLINS
ASI-815-1			MCU BOARD TEST FIXTURE WITH W1-W8	COLLINS
ASI-816-1			EXCHANGE SYSTEM BREAKOUT BOX WITH 5 CABLES	COLLINS

AVAILABILITY:

ASI DEALER: CONTACT ANY ASI DEALER FOR QUOTE
 COLLINS: CONTACT ROCKWELL COLLINS FOR QUOTE
 GABLES: CONTACT GABLES ENGINEERING FOR QUOTE
 TELEPHONICS: CONTACT TELEPHONICS FOR QUOTE

ASI SPECIALIZED TEST EQUIPMENT LIST

AVAILABILITY SUBJECT TO CHANGE WITHOUT NOTICE

<u>ASI MN</u>	<u>EQUIV MN</u>	<u>EQUIV PN</u>	<u>DESCRIPTION</u>	<u>AVAILABILITY</u>
ASI-816-2			EXCHANGE AIR SYSTEM BREAKOUT BOX WITH 2 CABLES	COLLINS
ASI-817		653-5113-001	RF/SIGNAL DISTRIBUTION PANEL WITH CABLE	COLLINS
ASI-818-1		TS-PC15-1	TEST SET FOR PC15 / PC-15A	ASI DEALER
ASI-818-2		TS-PC17-1	TEST SET FOR PC17/17-1/17-2/17-3/17-3A/17-3B/17-3C/SPC-60/60A/60C	ASI DEALER
ASI-818-21		TS-PC17A-1	TEST SET FOR PC-17A	ASI DEALER
ASI-818-3			TEST SET FOR PC-250/-251/-350 (REQUIRES OPTIONAL ASI-18-83X CABLES)	ASI DEALER
ASI-820-1			ALS TEST BOX (787)	COLLINS
ASI-820-2		4000-1130-001	ALS TEST BOX (EMBRAER)	COLLINS
ASI-820-3		4000-1140-001	ALS TEST BOX (BOMBARDIER)	COLLINS
ASI-820-4			HCP CABLE	COLLINS
ASI-821-1			DRY CAPACITANCE TEST FIXTURE FOR FG1006AA (FIG 901)	ASI DEALER
ASI-821-2			TEST CABLE AND CONNECTOR FOR FG1006AA (FIG 902)	ASI DEALER
ASI-825	973F-1	822-1888-001	RADIO TEST SET	COLLINS
ASI-854	CTS-854	622-6814-001	TEST SET FOR EFD-74 (REQUIRES USER SUPPLIED HCP-74)	COLLINS
ASI-856	CTS-856	622-6458-001	EFIS TEST SET	ASI DEALER
ASI-857	CTS-857	622-6582-001	EFIS DATA BUS ANALYZER TEST SET	ASI DEALER
ASI-859	CTS-859	622-7975-001	DIGITAL EFIS TEST SET SEE (ASI-CTS-859 FOR LATEST VERSION / -004)	ASI DEALER
ASI-900-1		983-8108-001	GPS TIME MARK ASSY FOR TDR-94/94D	ASI DEALER
ASI-900-2		983-8108-005	GPS TIME MARK ASSY FOR CISS	ASI DEALER
ASI-952	CTS-952	622-6632-001	CONTROL PANEL TEST SET	ASI DEALER
ASI-980L-1MM			METER RETROFIT KIT FOR COLLINS 980L-1 (NOT FOR USE WITH 980L-1A)	ASI DEALER
ASI-1000			INSTRUMENT TEST PANEL	ASI DEALER
ASI-1002			UNIVERSAL GABLES CONTROL HEAD TEST PANEL (AVAILABLE FROM GABLES)	GABLES
ASI-1002-2			UNIVERSAL BREAKOUT BOX FOR GABLES CONTROLS	ASI DEALER
ASI-1002-3			GABLES G6980 AUDIO MANAGEMENT UNIT TEST PANEL	ASI DEALER
ASI-1002-4			UNIVERSAL BREAKOUT BOX FOR GABLES CONTROLS (KLM VERSION)	ASI DEALER
ASI-1003-GAB			GABLES G7185 TEST PANEL	ASI DEALER
ASI-1003-RAY			PNEUMATIC FLOW CONTROL RAMP TEST SET	ASI DEALER
ASI-1003-1			GABLES TCAS CONTROL (G6990/G6992/G7131/G7156) TEST PANEL	ASI DEALER
ASI-1004	CT8122		PRESSURE SENSOR ELECTRONIC TEST PANEL	ASI DEALER
ASI-1005	CT2506		PRESSURE SENSOR PNEUMATIC TEST PANEL	ASI DEALER
ASI-1006		98A27608011001	A310 CONTROL BOX-SPOILER VALVE GROUP	ASI DEALER
ASI-1007		901-700-000-A0	COMPUTER INTERFACE BOX	ASI DEALER
ASI-1008	BB11-142A	NWA-00-3246-0-0011	ANTI-SKID/SPOILER DET PULLER	ASI DEALER
ASI-1009	PSD40-503		CABLE: 727-737	ASI DEALER
ASI-1010-1		GSE601303-001	INTERFACE CONTROL PANEL	ASI DEALER
ASI-1010-2		GSE601303-001	INTERFACE CONTROL PANEL (KLM MOD OF ASI-10101-1)	ASI DEALER
ASI-1011		170130	CARGO ELECTRONIC UNIT (CEU) TEST SET	ASI DEALER
ASI-1011-1		170145	CABLE SET FOR ASI-1011 (170130) CEU TEST SET (INCLUDES W1 AND W2)	ASI DEALER
ASI-1012			TEST ADAPTER FOR AMETEK 253884 SURFACE POSITION INDICATOR	ASI DEALER
ASI-1013		4374-01	CTI TEST SET	ASI DEALER
ASI-1013-1		101149-01-01	CTI TEST SET CABLE FOR SMITHS 2263-01	ASI DEALER
ASI-1014	CT21038		737 EPDS SPCU TEST PANEL	ASI DEALER
ASI-1014-1	CT24128		126 OHM LOAD FOR ASI-1014	ASI DEALER
ASI-1014-2			SPCU AC POWER PANEL FOR USE WITH ASI-1014	ASI DEALER
ASI-1014-3		51194381-001	SPCU RELAY TEST PANEL (SOFTWARE NOT INCLUDED)	ASI DEALER
ASI-1015		KLM3E-86566-00	CALIBRATION CONTROL UNIT FOR LT-90/92	ASI DEALER
ASI-1016		170180	DETECTION / SUPPRESSION PANEL (INCLUDES ASI-1016-1/-2/-3/-4 CABLES)	ASI DEALER
ASI-1016-1		170192	DETECTION / SUPPRESSION PANEL TEST CABLE FOR 473955-1 / 473955-9	ASI DEALER
ASI-1016-2		170228	CIRCUIT CARD / CONNECTOR ASSEMBLY TEST CABLE (PRE SB 473955-1-26-404)	ASI DEALER
ASI-1016-3		170395	CIRCUIT CARD / CONNECTOR ASSEMBLY TEST CABLE (POST SB 473955-1-26-404)	ASI DEALER
ASI-1016-4		172913	DETECTION / SUPPRESSION PANEL TEST CABLE FOR 473955-15	ASI DEALER
ASI-1017		170222	TIMER MONITOR	ASI DEALER
ASI-1018			M193 WINDOW HEAT MODULE ASSEMBLY TEST SET (ATA 30-41-01 FIG 5A)	ASI DEALER
ASI-1018-1			M193 WINDOW HEAT MODULE ASSEMBLY TEST SET (ATA 30-41-01 FIG 5)	ASI DEALER
ASI-1019-1			WINDOW HEAT CONTROL TEST FIXTURE FOR KOITO 8300-05603/4 / 10-61833-4/-6	ASI DEALER
ASI-1019-1A0			EXTENDER CARD A0 (30 PIN) FOR KOITO 8300-05603/4 / 10-61833-4/-6	ASI DEALER
ASI-1019-1A1			EXTENDER CARD A1 (40 PIN) FOR KOITO 8300-05603/4 / 10-61833-4/-6	ASI DEALER
ASI-1019-1A2			EXTENDER CARD A2 (40 PIN) FOR KOITO 8300-05603/4 / 10-61833-4/-6	ASI DEALER
ASI-1019-1A3			EXTENDER CARD A3 (50 PIN) FOR KOITO 8300-05603/4 / 10-61833-4/-6	ASI DEALER
ASI-1019-2			WINDOW HEAT CONTROL LOAD FIXTURE FOR KOITO 8300-05603/4 / 10-61833-4/-6	ASI DEALER
ASI-1020-1			POINT LEVEL SENSOR SIMULATION FIXTURE FOR 1742F3 / S417T108-7	ASI DEALER
ASI-1020-2			LCM LEVEL INTERFACE FIXTURE FOR 1742F3/5/6/8 / S417T108-7/-11/-14/-16	ASI DEALER
ASI-1020-3	BTR-9466		POINT LEVEL SENSOR SIM FIXTURE FOR 1742F3/5/6/8 / S417T108-7/-11/-14/-16	ASI DEALER
ASI-1021			VOLTAGE RATIO TEST CIRCUIT FOR 10-60554-XX	ASI DEALER
ASI-1025			TEST FIXTURE FOR BC1302	ASI DEALER
ASI-1026	BTCG-03		SMOKE DETECTION CONTROL UNIT TEST SET FOR CERBERUS RCGSK-10-0X	ASI DEALER
ASI-1026-1			SMOKE DETECTOR TEST FIXTURE FOR CERERBUS KTA-2400 (2 CHANNEL) FIG 103	ASI DEALER
ASI-1026-2			SMOKE DETECTOR TEST FIXTURE FOR CERERBUS KTA-2400 (6 CHANNEL) FIG 104	ASI DEALER

AVAILABILITY:

ASI DEALER: CONTACT ANY ASI DEALER FOR QUOTE
 COLLINS: CONTACT ROCKWELL COLLINS FOR QUOTE
 GABLES: CONTACT GABLES ENGINEERING FOR QUOTE
 TELEPHONICS: CONTACT TELEPHONICS FOR QUOTE

ASI SPECIALIZED TEST EQUIPMENT LIST

AVAILABILITY SUBJECT TO CHANGE WITHOUT NOTICE

<u>ASI MN</u>	<u>EQUIV MN</u>	<u>EQUIV PN</u>	<u>DESCRIPTION</u>	<u>AVAILABILITY</u>
ASI-1026-3			SMOKE DETECTOR TEST FIXTURE FOR CERERBUS FTA719-XX / FTA720-XX FIG 105	ASI DEALER
ASI-1027-1	CT8069		WINDOW HEAT CONTROL TEST PANEL FOR HONEYWELL 624066-X	ASI DEALER
ASI-1027-2	CT8073		SIMULATED LOAD	ASI DEALER
ASI-1027-3	CT8044		TEST FIXTURE	ASI DEALER
ASI-1028			CIRCUIT CARD TEST SET FOR 472266 / 898732	ASI DEALER
ASI-1029			WINDOW HEAT CONTROL UNITS TEST SET (ATA 30-41-06 FIG 1002)	ASI DEALER
ASI-1030			TEST FIXTURE FOR HELLA 8ES00523X SERIES POWER UNITS	ASI DEALER
ASI-1031-1			DIMMING CONTROL TEST PANEL	ASI DEALER
ASI-1032-1		NYLZ-52238	WINDOW DEFOG CONTROLLER TEST FIXTURE FOR SYLZ-51855	ASI DEALER
ASI-1032-2		NYLZ-52239	WINDOW DEFOG CONTROLLER LOAD FIXTURE FOR SYLZ-51855	ASI DEALER
ASI-1033			TEST FIXTURE FOR NORD-MICRO ELECTRONIC BOX 20995- ()	ASI DEALER
ASI-1034-1		71572	POWER SUPPLY TESTER FOR GRIMES 60-1321-1/-5	ASI DEALER
ASI-1034-2		63845	POWER SUPPLY TESTER FOR GRIMES 60-1321-7	ASI DEALER
ASI-1035			BREAKOUT / TEST SET FOR 284U1523-1 / 654U0061-X / 65B07320-X / 65B07322-X	ASI DEALER
ASI-1036			TARGET MOTION TEST FIXTURE FOR WHITTAKER 631051 PROXIMITY SWITCH	ASI DEALER
ASI-1036-1			TEST SET FOR WHITTAKER 631051 PROXIMITY SWITCH (INCLUDES ASI-1036)	ASI DEALER
ASI-1037			FUNCTIONAL TEST SET FOR 473597-18/-19 SMOKE DET (REQ ASI-10-37X CABLES)	ASI DEALER
ASI-1038		A301-460-001	EMERGENCY POWER SUPPLY TEST SET FOR D717-01-002 / D717-02-001	ASI DEALER
ASI-1039			RESERVED	TBA
ASI-1040		170424	CARGO BAY DETECTION/SUPPRESSION PANEL TEST SET (REQ ASI-10-40A CABLE)	ASI DEALER
ASI-1041		170301	CONTROL UNIT TEST SET FOR KIDDE 473889-4 (REQ ASI-10-41X CABLES)	ASI DEALER
ASI-1042			RESERVED	TBA
ASI-1043		170819	M3000 MANUAL TEST SET FOR KIDDEE 474560	ASI DEALER
ASI-1044		474610	SMOKE BOX ASSY FOR KIDDE 474560	COLLINS
ASI-1045-2		473305-2	FUNCTIONAL TEST CIRCUIT HARNESS FOR KIDDEE 30-231-9	
ASI-0012-00		245-0012-00	CABLE: EGPWS (LRU TEST CABLE)	ASI DEALER
ASI-0016-038		117-0016-038	ERECTION ACCURACY FIXTURE	COLLINS
ASI-0150-001		828-1050-001	COAX SWITCHING MODULE (CSSI-1000)	ASI DEALER
ASI-0182-DLC		827-0182-001	DLC-800() POWER SUPPLY TEST FIXTURE	ASI DEALER
ASI-0201-DLM		827-0201-001	DLM-700() BREAKOUT TO MU CABLE	ASI DEALER
ASI-0202-DLM		827-0201-004	DLM-700() BREAKOUT TO LOOP BACK CABLE	ASI DEALER
ASI-0303-001		629-0303-001	CABLE: PWR SUP / PWR AMP (P/O ASI-2752-159)	ASI DEALER
ASI-0304-001		629-0304-001	CABLE: SW UNIT (P/O ASI-2752-159)	ASI DEALER
ASI-0312-001		629-0312-001	CABLE: FREQ / SYNTH (P/O ASI-2752-159)	ASI DEALER
ASI-0317-001		629-0317-001	CABLE: XLTR/MOD (P/O ASI-2752-159)	ASI DEALER
ASI-0319-070		229-0319-070	SVO-85/1000 FLUX KEEPER	ASI DEALER
ASI-0319-120		229-0319-120	SVO-1000 FLUX KEEPER	ASI DEALER
ASI-0343-001		830-0343-001	CABLE: NO. 1	ASI DEALER
ASI-0344-001		830-0344-001	CABLE: NO. 2	ASI DEALER
ASI-0345-001		830-0345-001	CABLE: NO. 3	ASI DEALER
ASI-0412-001			ADF ANTENNA SIMULATOR BREAKOUT/TEST BOX	ASI DEALER
ASI-0428-001		629-0428-001	CABLE: GUARD REC (P/O ASI-2752-159)	ASI DEALER
ASI-0433-001		629-0433-001	CABLE: IF/AF AMP (P/O ASI-2752-159)	ASI DEALER
ASI-0465-DLC		827-0465-001	DLC-800() TEST PANEL W/CABLE	ASI DEALER
ASI-0465-003		827-0465-003	CABLE: ASI-0465-DLC TO DLC-800()	ASI DEALER
ASI-0491-001		649-0491-001	BREAKOUT-BOX ASSEMBLY (ALLIED SIGNAL)	ASI DEALER
ASI-0491-002		649-0491-002	BREAKOUT-BOX ASSEMBLY (ALLIED SIGNAL)	ASI DEALER
ASI-0501-001		828-0501-001	A1 BOARD PROGRAMMER FOR HFS-700D/900D	COLLINS
ASI-0511-001		638-0511-001	AHC-85 DUAL MULTISENSOR TESTER	COLLINS
ASI-0519-001		751-0519-001	THINLINE CONTACT EXTRACTOR (INCL TOOL 751-0519-001 & HANDLE 007-0611-000)	ASI DEALER
ASI-0740-001		791-0740-001	51RV-2B SLICE EXTENDER KIT	ASI DEALER
ASI-0780-02		55-0780-02	PSDA300-1 CENTER TANK ADAPTER CABLE	ASI DEALER
ASI-0788-001		987-0788-001	TEST SET	COLLINS
ASI-0795-001		442-0795-001	POWER ADAPTER TEST FIXTURE	COLLINS
ASI-0896-001		987-0896-001	CABLE: ELECTRICAL POWER	COLLINS
ASI-0897-001		987-0897-001	CABLE: UUT	COLLINS
ASI-0998-001		772-0998-001	590A-3()ALLEN-HEAD WRENCH	COLLINS
ASI-1207A	TS-1207A	4000595-0701	RADAR TEST SET (KPN 071-05108-000)	ASI DEALER
ASI-1100-DLM		827-1100-002	DLM-700() BREAKOUT PANEL	ASI DEALER
ASI-1130-DLM		827-1130-001	DLM-700() POWER DISTRIBUTION PANEL W/3 CABLES	ASI DEALER
ASI-1226-010		638-1226-010	CABLE: ASI-CTS-974 CHROME INTERFACE	ASI DEALER
ASI-1226-075		638-1226-075	CABLE: ASI-CTS-974 TO FCP-65	ASI DEALER
ASI-1226-076		638-1226-076	CABLE: ASI-CTS-974 TO MAP-65	ASI DEALER
ASI-1226-077		638-1226-077	CABLE: ASI-CTS-974 TO IND-42	ASI DEALER
ASI-1226-078		638-1226-078	CABLE: ASI-CTS-974 TO TCU-906	ASI DEALER
ASI-1226-079		638-1226-079	CABLE: ASI-CTS-974 TO CAD-31/62	ASI DEALER
ASI-1226-080		638-1226-080	CABLE: ASI-CTS-974 TO CAD-870G	ASI DEALER
ASI-1226-081		638-1226-081	CABLE: ASI-CTS-974 TO CAD-870/875 / RAC-870/875	ASI DEALER

AVAILABILITY:

ASI DEALER: CONTACT ANY ASI DEALER FOR QUOTE
 COLLINS: CONTACT ROCKWELL COLLINS FOR QUOTE
 GABLES: CONTACT GABLES ENGINEERING FOR QUOTE
 TELEPHONICS: CONTACT TELEPHONICS FOR QUOTE

ASI SPECIALIZED TEST EQUIPMENT LIST

AVAILABILITY SUBJECT TO CHANGE WITHOUT NOTICE

<u>ASI MN</u>	<u>EQUIV MN</u>	<u>EQUIV PN</u>	<u>DESCRIPTION</u>	<u>AVAILABILITY</u>
ASI-1226-082		638-1226-082	CABLE: ASI-CTS-974 TO RTU-870	ASI DEALER
ASI-1226-083		638-1226-083	CABLE: ASI-CTS-974 TO ALI-80 / MSI-80 / VSI-80	ASI DEALER
ASI-1226-084		638-1226-084	CABLE: ASI-CTS-974 TO PRE-80	ASI DEALER
ASI-1226-085		638-1226-085	CABLE: ASI-CTS-974 TO TAI-80	ASI DEALER
ASI-1226-110		638-1226-110	CABLE: ASI-CTS-974 CHROME DATA	ASI DEALER
ASI-1229-001		634-1229-001	CABLE ASSY	COLLINS
ASI-1233-001		830-1233-001	DATA LOADER ADAPTER CABLE	ASI DEALER
ASI-1253-001		987-1253-001	CABLE: RS-232	COLLINS
ASI-1254-001		987-1254-001	CABLE: RS-422	COLLINS
ASI-1305-001		634-1305-001	CABLE ASSY	COLLINS
ASI-1316-001		638-1316-001	LN2 CHAMBER RACK MOUNT	COLLINS
ASI-1374-030		987-1374-030	RESOURCE PANEL TEST CABLE: CDU-7000	ASI DEALER
ASI-1374-040		987-1374-040	RESOURCE PANEL TEST CABLE	ASI DEALER
ASI-1374-050		987-1374-050	RESOURCE PANEL TEST CABLE	ASI DEALER
ASI-1374-060		987-1374-060	RESOURCE PANEL TEST CABLE	ASI DEALER
ASI-1374-070		987-1374-070	RESOURCE PANEL TEST CABLE	ASI DEALER
ASI-1374-075		987-1374-075	RESOURCE PANEL TEST CABLE	ASI DEALER
ASI-1374-078		987-1374-078	RESOURCE PANEL TEST CABLE	ASI DEALER
ASI-1429-001		609-1429-001	CABLE-EXTENDER ASSY RF MODULE IN 671U-4()	ASI DEALER
ASI-1438-001		609-1438-001	CABLE-EXTENDER ASSY FOR POWER SUPPLY IN 671U-4()	ASI DEALER
ASI-1522-DLM		827-1522-009	DLM-700() ACARS LOOPBACK POD	ASI DEALER
ASI-1569-010	G48C	013-1569-010	ANTENNA FOR 972Q-4	ASI DEALER
ASI-1577-001		827-1577-001	TEST ADAPTER ASSY	ASI DEALER
ASI-1588-001		827-1588-001	TEST ADAPTER ASSY	ASI DEALER
ASI-1627-001		638-1627-001	RTA-4XXX WW-MAP LOAD BOX (REPLACED BY ASI-4922-001 / 964-4922-001)	COLLINS
ASI-1652-001		830-1652-001	DATA LOADER CABLE, SDU-906	ASI DEALER
ASI-1773-001		634-1773-001	SEE ASI-21-24A	ASI DEALER
ASI-1902-001		651-1902-001	WRT-701X PWR AMP TEST COVER (P/O ASI-7994-701X)	ASI DEALER
ASI-1903-001		651-1903-001	WRT-701X COUPLER LOAD PORT ADAPTER (R/B ASI-1920-001)	ASI DEALER
ASI-1904-001		651-1904-001	WRT-701X EXTENDER CABLE (P/O ASI-7994-701X)	ASI DEALER
ASI-1904-002		651-1904-002	WRT-701X EXTENDER CABLE (P/O ASI-7994-701X)	ASI DEALER
ASI-1904-003		651-1904-003	WRT-701X EXTENDER CABLE (P/O ASI-7994-701X)	ASI DEALER
ASI-1904-004		651-1904-004	WRT-701X EXTENDER CABLE (P/O ASI-7994-701X)	ASI DEALER
ASI-1904-005		651-1904-005	WRT-701X EXTENDER CABLE (P/O ASI-7994-701X)	ASI DEALER
ASI-1904-006		651-1904-006	WRT-701X EXTENDER CABLE (P/O ASI-7994-701X)	ASI DEALER
ASI-1904-007		651-1904-007	WRT-701X EXTENDER CABLE (P/O ASI-7994-701X)	ASI DEALER
ASI-1904-008		651-1904-008	WRT-701X EXTENDER CABLE (P/O ASI-7994-701X)	ASI DEALER
ASI-1909-001		651-1909-001	WRT-701X EXTENDER CABLE (P/O ASI-7994-701X)	ASI DEALER
ASI-1910-001		651-1910-001	WRT-701X MULTIPLIER TEST FIXTURE (P/O ASI-7994-701X)	ASI DEALER
ASI-1914-001		651-1914-001	WRT-701X EXTENDER CABLE (P/O ASI-7994-701X)	ASI DEALER
ASI-1915-001		651-1915-001	WRT-701X TEST COVER (P/O ASI-7994-701X)	ASI DEALER
ASI-1916-001		651-1916-001	WRT-701X TEST COVER (P/O ASI-7994-701X)	ASI DEALER
ASI-1917-001		651-1917-001	WRT-701X TEST COVER (P/O ASI-7994-701X)	ASI DEALER
ASI-1918-001		651-1918-001	WRT-701X TEST COVER (P/O ASI-7994-701X)	ASI DEALER
ASI-1919-001		651-1919-001	WRT-701X TEST COVER (P/O ASI-7994-701X)	ASI DEALER
ASI-1920-001		651-1920-001	WRT-701X TEST COVER (P/O ASI-7994-701X)	ASI DEALER
ASI-1934-DLC		647-1934-000	BACKLIGHT TEST FIXTURE FOR COLLINS DLC-800	ASI DEALER
ASI-2000			MAINFRAME (REQUIRES ASI-200-X PLUG-INS)	ASI DEALER
ASI-2001			PRO LINE COMPUTER SYSTEM (INCLUDES INTERNAL ASI-CTC-429 AND ASI-401-ISA)	ASI DEALER
ASI-2001-1			PRO LINE COMPUTER SYSTEM (INCLUDES INTERNAL ASI-401-ISA)	ASI DEALER
ASI-2001-2			PRO LINE COMPUTER SYSTEM (INCLUDES INTERNAL ASI-CTC-429)	ASI DEALER
ASI-2001-3			PRO LINE COMPUTER SYSTEM (COMPUTER ONLY)	ASI DEALER
ASI-2001-4			COMPUTER SYSTEM PER AHC CMM SPECS	COLLINS
ASI-2002			APPLE IIe COMPUTER SYS FOR KDM/KFS TEST (INCLUDES ASYNC & SYNC CARDS)	ASI DEALER
ASI-2002-1			APPLE IIe COMPUTER SYS FOR KDM/KFS TEST (INCLUDES ASYNC CARD)	ASI DEALER
ASI-2002-2			APPLE IIe COMPUTER SYS FOR KDM/KFS TEST (INCLUDES SYNC CARD)	ASI DEALER
ASI-2002-3			APPLE IIe COMPUTER SYS FOR KDM/KFS TEST (COMPUTER/MONITOR/DRIVE ONLY)	ASI DEALER
ASI-2013-002		987-2013-002	CABLE: ITA W2	ASI DEALER
ASI-2013-003		987-2013-003	CABLE: ITA W3	ASI DEALER
ASI-2013-008		987-2013-008	CABLE: ITA W8	ASI DEALER
ASI-2013-010		987-2013-010	CABLE: ITA W10	ASI DEALER
ASI-2013-012		987-2013-012	CABLE: ITA W12	ASI DEALER
ASI-2013-034		987-2013-034	CABLE: ITA W38	ASI DEALER
ASI-2058-001		822-2058-001	JTRS CLUSTER 1 RF MUX PANEL	ASI DEALER
ASI-2107-001		634-2107-001	ANTENNA ADAPTER PLATE (P/O ASI-4287-203)	COLLINS
ASI-2171-010			NICAD BATTERY FOR 972Q-4 / AN/ARM-186 (REPLACES 221-2171-010)	ASI DEALER
ASI-2214-001		601-2214-001	EXTENDER CARD FOR ADI-85 (P/O ASI-9999-001 KIT)	ASI DEALER
ASI-2216-001		601-2216-001	EXTENDER CARD FOR HSI-85 A2/A3/A4 (P/O ASI-9999-001 KIT)	ASI DEALER
ASI-2221-001		638-2221-001	EXTENDER NO. 1: ADC-80/81/82	ASI DEALER

AVAILABILITY:

ASI DEALER: CONTACT ANY ASI DEALER FOR QUOTE
 COLLINS: CONTACT ROCKWELL COLLINS FOR QUOTE
 GABLES: CONTACT GABLES ENGINEERING FOR QUOTE
 TELEPHONICS: CONTACT TELEPHONICS FOR QUOTE

ASI SPECIALIZED TEST EQUIPMENT LIST

AVAILABILITY SUBJECT TO CHANGE WITHOUT NOTICE

<u>ASI MN</u>	<u>EQUIV MN</u>	<u>EQUIV PN</u>	<u>DESCRIPTION</u>	<u>AVAILABILITY</u>
ASI-2222-001		638-2222-001	EXTENDER NO. 2: ADC-80/81/82	ASI DEALER
ASI-2223-001		638-2223-001	EXTENDER NO. 3: PRE-80	ASI DEALER
ASI-2224-001		638-2224-001	EXTENDER NO. 4: ALI-80/MSI-80/VSI-80	ASI DEALER
ASI-2225-001		638-2225-001	EXTENDER NO. 5: ALI-80/MSI-80/VSI-80	ASI DEALER
ASI-2226-001		638-2226-001	EXTENDER NO. 6: ALI-80/MSI-80/VSI-80	ASI DEALER
ASI-2227-001		638-2227-001	EXTENDER KIT (INCLUDES NO.1 THRU NO. 6)	ASI DEALER
ASI-2235-001		621-2235-001	EXTENDER CABLE KIT: 860E-4/5	ASI DEALER
ASI-2235-002		621-2235-002	EXTENDER CABLE KIT: 860E-4/5	ASI DEALER
ASI-2241-001		601-2241-001	EXTENDER CARD: ARC-186 RCVR IF (P/O ASI-2390-001/-002)	ASI DEALER
ASI-2242-001		601-2242-001	EXTENDER CARD: ARC-186 AUDIO (P/O ASI-2390-001/-002)	ASI DEALER
ASI-2243-001		601-2243-001	EXTENDER CARD: ARC-186 P/S (P/O ASI-2390-001/-002)	ASI DEALER
ASI-2244-001		601-2244-001	EXTENDER CARD: ARC-186 RCVR RF (P/O ASI-2390-001/-002)	ASI DEALER
ASI-2244-001A		621-2244-001	CABLE: RF NO 1 (P/O ASI-2235-001/-002)	ASI DEALER
ASI-2245-001		621-2245-001	CABLE: RF NO 2 (P/O ASI-2235-001/-002)	ASI DEALER
ASI-2248-001		621-2248-001	CABLE: ATE (P/O ASI-2235-001)	ASI DEALER
ASI-2248-002		621-2248-002	CABLE: ATE (P/O ASI-2235-002)	ASI DEALER
ASI-2370-101		827-2370-101	DCP-5020 TEST ADAPTER	COLLINS
ASI-2370-102		827-2370-102	DCP-3030 TEST ADAPTER	COLLINS
ASI-2370-104		827-2370-104	CCP-3000 TEST ADAPTER	COLLINS
ASI-2389-002		638-2389-002	INTERCONNECT CABLE SET FOR AN/ARC-186 (USE WITH AN/ARM-173)	ASI DEALER
ASI-2390-001		638-2390-001	EXT CABLE SET FOR AN/ARC-186	ASI DEALER
ASI-2390-002		638-2390-002	EXT CABLE SET FOR AN/ARC-186 (INCL THREE 1553 CABLES)	ASI DEALER
ASI-2421-001		827-2421-001	SVO-3000 CABLE ASSY	ASI DEALER
ASI-2421-002		827-2421-002	SVO-3000 CABLE ASSY	ASI DEALER
ASI-2421-003		827-2421-003	SVO-3000 CABLE ASSY	ASI DEALER
ASI-2587-001		987-2587-001	MFD-286P ADAPTER CABLE	ASI DEALER
ASI-2599-001		830-2599-001	EDU TALK OUT TEST FIXTURE	ASI DEALER
ASI-2635-010			NICAD BATTERY CHARGER FOR 972Q-4 / AN/ARM-186 (REPLACES 270-2635-010)	ASI DEALER
ASI-2635-010-220			NICAD BATTERY CHARGER FOR 972Q-4 / AN/ARM-186 (220 VOLT)	ASI DEALER
ASI-2647-001		827-2647-001	DCP-400X DATA LOADER CABLE ASSY	COLLINS
ASI-2752-159		622-2752-001	ARC-159 EXTENDER CABLE SET	ASI DEALER
ASI-2756-001		830-2756-001	WRT-701X TEST COVER (P/O ASI-7994-701X)	ASI DEALER
ASI-2800		ACA4800GU-1	ION DISPERSAL UNIT (REQUIRES AIC2MJ FROM ALPHALAB FOR PROPER OPERATION)	ASI DEALER
ASI-2904-F51			SINGLE SIDED EXT CARD FOR SMITHS IND 2904-F5	ASI DEALER
ASI-2904-F52			DOUBLE SIDED EXT CARD FOR SMITHS IND 2904-F5	ASI DEALER
ASI-2936-010		270-2936-010	DUAL AXIS INCLINOMETER (P/O ASI-4287-203)	ASI DEALER
ASI-3056-001		988-3056-001	COAX CABLE ASSY	COLLINS
ASI-3109-001		828-3109-001	CABLE: CTS-88	COLLINS
ASI-3109-002		653-4242-001	CABLE: ASI-CTS-958 TO AHC-3000/A (828-3109-002)	COLLINS
ASI-3121-001		651-3121-001	CABLE: 966D-5A TO R/T (W2)	ASI DEALER
ASI-3358-001		830-3358-001	WMA-701/702X SHIMMING PRY TOOL NO 1 (MAN FIG 918)	ASI DEALER
ASI-3360-001		830-3360-001	WMA-701/702X SHIMMING PRY TOOL NO 2 (MAN FIG 919)	ASI DEALER
ASI-3364-001		830-3364-001	WMA-701/702X SHIMMING PRY TOOL NO 5 (MAN FIG 917)	ASI DEALER
ASI-3368-001		992-3368-001	UMT-16() LEVELING / ALIGNMENT FIXTURE FOR AHC-85()	ASI DEALER
ASI-3413-001		828-3413-001	ADC-850 MODULE ADAPTER	COLLINS
ASI-3413-002		828-3413-002	ADC-850 MODULE ADAPTER	COLLINS
ASI-3423-001		659-3423-001	DFC-206A CONTROL TEST PANEL	ASI DEALER
ASI-3605-097		135-3605-097	DSP-2000 TORQUE ADJUSTMENT TOOL	COLLINS
ASI-3620-001		827-3620-001	CABLE ASSY	COLLINS
ASI-3758-001		618-3758-001	913K-1 EXTENDER CARD, FRONT	ASI DEALER
ASI-3759-001		618-3759-001	913K-1 EXTENDER CARD, BACK	ASI DEALER
ASI-3829-001		830-3829-001	WMA-701/702X SHIMMING PRY TOOL NO 6 (MAN FIG 915)	ASI DEALER
ASI-3830-001		830-3830-001	WMA-701/702X SHIMMING PRY TOOL NO 7 (MAN FIG 916)	ASI DEALER
ASI-3831-001		830-3831-001	WMA-701/702X AIRBORNE GEAR SHIMMING KIT	ASI DEALER
ASI-3842-DLM		676-3842-001	DLM-700() A6 POWER SUPPLY TEST SET (FOR CPN 676-7059-002 ONLY)	ASI DEALER
ASI-4015-186		647-4015-001	INTERCONNECT CABLE SET FOR AN/ARC-186 (USE WITH AN/ARM-165)	ASI DEALER
ASI-4016-001		647-4016-001	CABLE: W1 (P/O ASI-4015-186)	ASI DEALER
ASI-4093-001		647-4093-001	CABLE: W2 (P/O ASI-4015-186) SAME AS ASI-9037-001 (634-9037-001)	ASI DEALER
ASI-4094-001		647-4094-001	CABLE: W3 (P/O ASI-4015-186) SAME AS ASI-9039-001 (634-9039-001)	ASI DEALER
ASI-4095-001		647-4095-001	CABLE: W4 (P/O ASI-4015-186) SAME AS ASI-9035-001 (634-9035-001)	ASI DEALER
ASI-4096-001		647-4096-001	CABLE: W5 (P/O ASI-4015-186) SAME AS ASI-9036-001 (634-9036-001)	ASI DEALER
ASI-4287-054		983-4287-054	ZERO SENSOR HOUSING TEST COVER	ASI DEALER
ASI-4287-055		983-4287-055	MOUTING BLOCK (P/O ASI-4287-203)	COLLINS
ASI-4287-056		983-4287-056	COUNTERWEIGHT (P/O ASI-4287-203)	COLLINS
ASI-4287-201		983-4287-201	ZERO MON CAL FIXTURE	ASI DEALER
ASI-4287-202		983-4287-202	CABLE: ZERO SENSOR	ASI DEALER
ASI-4287-203		983-4287-203	WMA INCLINOMETER / COUNTERWEIGHT ASSEMBLY	ASI DEALER
ASI-4287-205		983-4287-205	CABLE: SCAN ZERO SENSOR	ASI DEALER
ASI-4287-250		983-4287-250	INCLINOMETER INTERFACE (P/O ASI-4287-203)	COLLINS

AVAILABILITY:

ASI DEALER: CONTACT ANY ASI DEALER FOR QUOTE
 COLLINS: CONTACT ROCKWELL COLLINS FOR QUOTE
 GABLES: CONTACT GABLES ENGINEERING FOR QUOTE
 TELEPHONICS: CONTACT TELEPHONICS FOR QUOTE

ASI SPECIALIZED TEST EQUIPMENT LIST

AVAILABILITY SUBJECT TO CHANGE WITHOUT NOTICE

<u>ASI MN</u>	<u>EQUIV MN</u>	<u>EQUIV PN</u>	<u>DESCRIPTION</u>	<u>AVAILABILITY</u>
ASI-4652-001		641-4652-001	EXTENDER BOARD NO. 1 FOR 590A-3K/K1	ASI DEALER
ASI-4652-002		641-4652-002	EXTENDER BOARD NO. 2 FOR 590A-3K/K1	ASI DEALER
ASI-4667-001		983-4667-001	CABLE: RF	ASI DEALER
ASI-4759-001		601-4759-001	913K-1A/2H EXTENDER CARD, BACK	ASI DEALER
ASI-4920-001		629-4920-001	EXTENDER CARD FOR FPC-75 A4 (P/O ASI-9046-001 KIT)	ASI DEALER
ASI-4922-001		964-4922-001	RTA-4XXX WW-MAP LOAD BOX	ASI DEALER
ASI-4925-001		629-4920-001	EXTENDER CARD FOR FPC-75 A6 (P/O ASI-9046-001 KIT)	ASI DEALER
ASI-4928-001		629-4920-001	EXTENDER CARD FOR FPC-75 A5 (P/O ASI-9046-001 KIT)	ASI DEALER
ASI-5058-001		641-5058-001	HSI-85() CARD EXTRACTOR	ASI DEALER
ASI-5058-002		641-5058-002	ADI-85() CARD EXTRACTOR	ASI DEALER
ASI-5687-001		635-5687-001	CABLE: RCVR (P/O ASI-2235-001/-002)	ASI DEALER
ASI-5688-001		635-5688-001	CABLE: PWR AMP (P/O ASI-2235-001/-002)	ASI DEALER
ASI-5689-001		635-5689-001	CABLE: DRVR (P/O ASI-2235-001/-002)	ASI DEALER
ASI-6041-3782-200		6041-3782-200	CABLE: IFR STD-7000 TO CRT INTERFACE ASSY	ASI DEALER
ASI-6041-3782-300		6041-3782-300	CABLE: IFR CRT INTERFACE ASSY (7005-3742-400) TO MONITOR	ASI DEALER
ASI-6042			CABLE: ASI-488 RF	ASI DEALER
ASI-6046-3880-600		6046-3880-600	CABLE: IFR DF-7708 TO STD-7000	ASI DEALER
ASI-6046-3880-700		6046-3880-700	CABLE: IFR DF-7708 TO COLLINS RADAR ANTENNA	ASI DEALER
ASI-6046-3880-800		6046-3880-800	CABLE: IFR DF-7708 TO COLLINS RADAR CONTROL	ASI DEALER
ASI-6046-3880-900		6046-3880-900	CABLE: IFR DF-7708 TO COLLINS RADAR INDICATOR	ASI DEALER
ASI-6046-3881-000		6046-3881-000	CABLE: IFR DF-7708 TO COLLINS RADAR R/T	ASI DEALER
ASI-6046-3881-500		6046-3881-500	CABLE: IFR DF-7708 TO COLLINS CONTROL (ADAPTER)	ASI DEALER
ASI-618-8938-001		618-8938-001	EXTENDER BOARD FOR 972V-1	ASI DEALER
ASI-6301-002		628-6301-102	BOARD: PROM	COLLINS
ASI-6382-628T		635-6382-001	628T-1/1A HARNESS TEST SET (REPLACED BY ASI-209-6)	ASI DEALER
ASI-6695-050		987-6695-050	CABLE: ELECTRICAL INTERFACE	COLLINS
ASI-6695-051		987-6695-051	CABLE: ELECTRICAL INTERFACE	COLLINS
ASI-6769-001		617-6769-001	ADAPTER CABLE: 973L-1/635U	ASI DEALER
ASI-6787-001	CTS-90	622-6787-001	INTERCONNECT CABLE SET FOR VCN-186 / C-11029()	ASI DEALER
ASI-6900-002		830-6900-002	CABLE: A51 NOISE DIODE BREAKOUT FOR WRT-701X / WRT-2100	ASI DEALER
ASI-6900-003		830-6900-003	CABLE: A50 SOURCE EXTENDER FOR WRT-701X / WRT-2100	ASI DEALER
ASI-6943-001		830-6943-001	DRIVE EXT CABLE AND CONTROL BOX FOR WRT-701X (WS) (P/O ASI-6960-001)	ASI DEALER
ASI-6944-001		830-6944-001	SEC IF A8 EXT CABLE AND CONTROL BOX FOR WRT-701X (WS) (P/O ASI-6960-001)	ASI DEALER
ASI-6945-001		830-6945-001	NOISE DIODE TEST BOX FOR WRT-701X (WS) (P/O ASI-6960-001)	ASI DEALER
ASI-6946-001		830-6946-001	CABLE: PREDM EXTENDER (P/O ASI-6960-001)	ASI DEALER
ASI-6946-002		830-6946-002	CABLE: MULTIPLIER EXTENDER (P/O ASI-6960-001)	ASI DEALER
ASI-6946-003		830-6946-003	CABLE: MIXER A7 EXTENDER (P/O ASI-6960-001)	ASI DEALER
ASI-6946-004		830-6946-004	CABLE: RF EXTENDER (P/O ASI-6960-001)	ASI DEALER
ASI-6951-001		830-6951-001	TUNING COVER (P/O ASI-6960-001)	ASI DEALER
ASI-6952-001		830-6952-001	TUNING COVER (P/O ASI-6960-001)	ASI DEALER
ASI-6953-001		830-6953-001	TUNING COVER (P/O ASI-6960-001)	ASI DEALER
ASI-6954-001		830-6954-001	TUNING COVER (P/O ASI-6960-001)	ASI DEALER
ASI-6964-628T		642-6964-001	COLLINS 628T-2/2A TEST KIT (INCLUDES ASI-209-8 AND ASI-209-9)	ASI DEALER
ASI-6960-001		830-6960-001	WXR FLW RF ALIGNMENT KIT (ALT CPN: 099-4920-000)	ASI DEALER
ASI-7000-701X			CPU ANALYZER FOR COLLINS WRT-701X	ASI DEALER
ASI-7005-3741-800		7005-3741-800	KEYBOARD ASSY FOR STD-7000	ASI DEALER
ASI-7005-3742-400		7005-3742-400	CRT INTERFACE ASSY FOR STD-7000	ASI DEALER
ASI-7005-4042-101	64372	7005-4042-101	EXTERNAL RF POWER MODULE ASSY FOR RDX-3000 / RDX-7708	ASI DEALER
ASI-7008-001		797-7008-001	345C-2A ACCELERATION SENSOR POS FIXTURE (345C-2A MANUAL FIGURE 1005)	ASI DEALER
ASI-716562-01		716562-01	EXTENDER CARD	ASI DEALER
ASI-7250-001		830-7250-001	DATA LOADER CABLE, SRT-2000	ASI DEALER
ASI-7263-001		752-7263-001	CABLE: MEM EXTENDER (P/O ASI-2390-002)	ASI DEALER
ASI-7264-001		752-7264-001	CABLE: EXTENDER (P/O ASI-2390-002)	ASI DEALER
ASI-7264-002		752-7264-002	CABLE: EXTENDER (P/O ASI-2390-002)	ASI DEALER
ASI-7366-001		827-7366-001	CABLE: METER W3 (P/O CTA-2028)	COLLINS
ASI-7367-001		827-7367-001	CABLE: SCOPE W4 (P/O CTA-2028)	COLLINS
ASI-7373-001		827-7373-001	DCU-4000/4001 POWER MONITOR TEST AID	COLLINS
ASI-7419-002		827-7419-002	RTU-42X0 DATA LOADER CABLE ASSY	ASI DEALER
ASI-7419-007		827-7419-007	RTU-40X0 DATA LOADER CABLE ASSY	COLLINS
ASI-7419-038		827-7419-038	"T" DATA LOAD CABLE	ASI DEALER
ASI-7424-001		830-7424-001	WRT LO FILTER TEST FIXTURE	ASI DEALER
ASI-7779-DLM(L)	659-8804-001	646-7779-001	DLM-700() CIRCUIT CARD EXTENDER-LEFT (A3,A4,A5)	ASI DEALER
ASI-7779-DLM(R)	659-8804-002	646-7779-002	DLM-700() CIRCUIT CARD EXTENDER-RIGHT (A6,A7)	ASI DEALER
ASI-7830-001		646-7830-001	EXTENDER CARD	ASI DEALER
ASI-7841-005		827-7841-005	TEMPLATE ASSY (P/O CTA-2052)	COLLINS
ASI-7847-001		827-7847-001	CABLE: CTS-2000 TO CDU-5000 (P/O CTA-2052)	COLLINS
ASI-7994-701C		659-7994-001	MAINTENANCE KIT FOR WRT-701C	ASI DEALER
ASI-7994-701X		659-7994-002	MAINTENANCE KIT FOR WRT-701X / WRT-2100	ASI DEALER
ASI-8001-001		791-8001-001	51RV-2B CARD EXTENDER CABLE FOR MANUAL VOR/LOC SENSOR CARD Z2	ASI DEALER

AVAILABILITY:

ASI DEALER: CONTACT ANY ASI DEALER FOR QUOTE
 COLLINS: CONTACT ROCKWELL COLLINS FOR QUOTE
 GABLES: CONTACT GABLES ENGINEERING FOR QUOTE
 TELEPHONICS: CONTACT TELEPHONICS FOR QUOTE

ASI SPECIALIZED TEST EQUIPMENT LIST

AVAILABILITY SUBJECT TO CHANGE WITHOUT NOTICE

<u>ASI MN</u>	<u>EQUIV MN</u>	<u>EQUIV PN</u>	<u>DESCRIPTION</u>	<u>AVAILABILITY</u>
ASI-8048-001		791-8048-001	51RV-2B CARD EXTENDER KIT	ASI DEALER
ASI-8092-010		372-8092-010	CRIMPING TOOL 90202-1 / 91516-1	ASI DEALER
ASI-8093-010		372-8093-010	EXTRACTION TOOL (SAME AS ASI-0519-001)	ASI DEALER
ASI-8139-001		629-8139-001	CABLE: APA-80 EXTENDER (38 POS-NOTCHED)	ASI DEALER
ASI-8139-002		629-8139-002	CABLE: APA-80 EXTENDER (30 POS)	ASI DEALER
ASI-8139-003		629-8139-003	CABLE: APA-80 EXTENDER (38 POS)	ASI DEALER
ASI-8140-001		629-8140-001	CABLE: FGC-80 A2J7 EXTENDER	ASI DEALER
ASI-8140-002		629-8140-002	CABLE: FGC-80 A2J6 EXTENDER	ASI DEALER
ASI-8140-003		629-8140-003	CABLE: FGC-80 A3J9 EXTENDER	ASI DEALER
ASI-8140-004		629-8140-004	CABLE: FGC-80 A3J8 EXTENDER	ASI DEALER
ASI-8140-005		629-8140-005	CABLE: FGC-80 A4J11 EXTENDER	ASI DEALER
ASI-8140-006		629-8140-006	CABLE: FGC-80 A4J10 EXTENDER	ASI DEALER
ASI-8140-007		629-8140-007	CABLE: FGC-80 A5J13 EXTENDER	ASI DEALER
ASI-8140-008		629-8140-008	CABLE: FGC-80 A5J12 EXTENDER	ASI DEALER
ASI-8140-009		629-8140-009	CABLE: FGC-80 A6J15 EXTENDER	ASI DEALER
ASI-8140-010		629-8140-010	CABLE: FGC-80 A6J14 EXTENDER	ASI DEALER
ASI-8140-011		629-8140-011	CABLE: FGC-80 A7J17 EXTENDER	ASI DEALER
ASI-8140-012		629-8140-012	CABLE: FGC-80 A7J16 EXTENDER	ASI DEALER
ASI-8260-DLC		646-8260-001	DLC-800() EXTENDER CARD (A3)	ASI DEALER
ASI-8261-DLC		646-8260-002	DLC-800() EXTENDER CARD (A4,A5,A6,A7)	ASI DEALER
ASI-8262-DLC			DLC-800() EXTENDER CABLE (A8)	ASI DEALER
ASI-8263-DLC			DLC-800() EXTENDER CABLE (A7,A9)	ASI DEALER
ASI-8264-DLC			DLC-800() EXTENDER CABLE (A2A1)	ASI DEALER
ASI-8265-DLC			DLC-800() EXTENDER CABLE (LCD)	ASI DEALER
ASI-8266-DLC			DLC-800() EXTENDER CABLE (A5,A6)	ASI DEALER
ASI-8267-DLC			DLC-800() CARD PULLER	ASI DEALER
ASI-8268-DLC		HT/100E-32K	DLC-800() DUMB TERMINAL (HANDHELD)	ASI DEALER
ASI-8271-001		827-8271-001	A1 INTERFACE BOX ASSY	COLLINS
ASI-8272-001		827-8272-001	A2 INTERFACE BOX ASSY	COLLINS
ASI-8273-001		827-8273-001	A5 INTERFACE BOX ASSY	COLLINS
ASI-8274-001		827-8274-001	W49 RIBBON CABLE ASSY	COLLINS
ASI-8274-002		827-8274-002	W47 RIBBON CABLE ASSY	COLLINS
ASI-8274-003		827-8274-003	W48 RIBBON CABLE ASSY	COLLINS
ASI-8292-006		548-8292-006	RADIO TEST HARNESS SUBASSY	ASI DEALER
ASI-835000		835000	500 NS DELAY LINE	ASI DEALER
ASI-835000-CSK			COIL SECURING KIT	ASI DEALER
ASI-8342-001		752-8342-001	DIPLXER/PREAMP TEST FIXTURE (WITH 2 CABLES)	ASI DEALER
ASI-8361-001		830-8361-001	CMU-900 POWER SUPPLY TESTER	COLLINS
ASI-8431-001		659-8431-001	SDU-640 PROG FIXTURE CABLE ASSY	COLLINS
ASI-8405-001		791-8405-001	MAINTENANCE KIT FOR 860E-3	ASI DEALER
ASI-8560-003	TS-1949A	757-8560-003	RADIO SET TEST HARNESS (P/O ASI-209-2B)	ASI DEALER
ASI-8633-050		827-8633-050	TEST SET	ASI DEALER
ASI-880060-1		880060-1	POSITION INDICATOR SWITCH ASSY	ASI DEALER
ASI-8803-DLM		659-8803-003	DATA LINK TEST ADAPTER	ASI DEALER
ASI-8904-001		628-8904-001	ECU-3000 TEST CABLE	COLLINS
ASI-8938-001		618-8938-001	EXTENDER BOARD FOR 972V-1 / REPLACED BY ASI-618-8938-001	NLA
ASI-9023-001		634-9023-001	CABLE: POWER SUPPLY (P/O ASI-9305-118)	ASI DEALER
ASI-9024-001		634-9024-001	CABLE: RECEIVER (P/O ASI-9305-118)	ASI DEALER
ASI-9025-001		634-9025-001	CABLE: SYNTH DRIVER (P/O ASI-9305-118)	ASI DEALER
ASI-9030-001		634-9030-001	CABLE: RF (P/O ASI-9305-118)	ASI DEALER
ASI-9031-001		634-9031-001	CABLE: RF (P/O ASI-9305-118)	ASI DEALER
ASI-9033-001		634-9033-001	CABLE: RF (P/O ASI-9305-118)	ASI DEALER
ASI-9035-001		634-9035-001	CABLE: W4 (P/O ASI-2389-002) SAME AS ASI-4095-001 (647-4095-001)	ASI DEALER
ASI-9036-001		634-9036-001	CABLE: W5 (P/O ASI-2389-002) SAME AS ASI-4096-001 (647-4096-001)	ASI DEALER
ASI-9037-001		634-9037-001	CABLE: W2 (P/O ASI-2389-002) SAME AS ASI-4093-001 (647-4093-001)	ASI DEALER
ASI-9038-001		634-9038-001	CABLE: W1 (P/O ASI-2389-002)	ASI DEALER
ASI-9039-001		634-9039-001	CABLE: W3 (P/O ASI-2389-002)	ASI DEALER
ASI-9046-001		629-9046-001	EXTENDER CARD SET FOR FPC-75 (INCLUDES A4, A5, AND A6 EXTENDERS)	ASI DEALER
ASI-920032		920032	CABLE: ANTENNA ADAPTER	ASI DEALER
ASI-9202-001		629-9202-001	CABLE: 972V-1 TO 331A-8H INDICATOR (8 IN)	ASI DEALER
ASI-9202-002		629-9202-002	CABLE: 972V-1 TO 331A-8H INDICATOR (48 IN) / SEE ASI-22-6A FOR ALTERNATE	ASI DEALER
ASI-9276-001		988-9276-001	CABLE: MFD-255E BURN IN, TURKEY-PHOENIX	COLLINS
ASI-930005-101		930005-101	ALIGNMENT TOOL FOR DBS2100 ASTV (PRICE INCLUDES 2 DIGITAL PROTRACTORS)	ASI DEALER
ASI-9305-118		629-9305-001	COLLINS TCN-118 MAINTENANCE KIT	ASI DEALER
ASI-931101-100-1		931101-100-1	RDU BREAKOUT BOX	ASI DEALER
ASI-931402		931402	CABLE: ANT/DAU	ASI DEALER
ASI-931407-100		931407-100	CABLE: RDU CONFIGURATION ADAPTER	ASI DEALER
ASI-932400-105-1		932400-105-1	CABLE: GEM-P4 TP SSP-P3	ASI DEALER
ASI-932400-105-2		932400-105-2	CABLE: TMU-P1 TO GEM-P1	ASI DEALER

AVAILABILITY:

ASI DEALER: CONTACT ANY ASI DEALER FOR QUOTE
 COLLINS: CONTACT ROCKWELL COLLINS FOR QUOTE
 GABLES: CONTACT GABLES ENGINEERING FOR QUOTE
 TELEPHONICS: CONTACT TELEPHONICS FOR QUOTE

ASI SPECIALIZED TEST EQUIPMENT LIST

AVAILABILITY SUBJECT TO CHANGE WITHOUT NOTICE

<u>ASI MN</u>	<u>EQUIV MN</u>	<u>EQUIV PN</u>	<u>DESCRIPTION</u>	<u>AVAILABILITY</u>
ASI-933428-100		933428-100	CABLE: IRDM	ASI DEALER
ASI-933436-100		933436-100	CABLE: IR INTERFACE DONGLE	ASI DEALER
ASI-9496-001		629-9496-001	CABLE: FRONT PNL EXTENDER (P/O ASI-2752-159)	ASI DEALER
ASI-9497-001		629-9497-001	CABLE: SIGNAL COND EXTENDER (P/O ASI-2752-159)	ASI DEALER
ASI-9498-001		629-9498-001	CABLE: MAN CONT EXTENDER (P/O ASI-2752-159)	ASI DEALER
ASI-9499-001		629-9499-001	CABLE: MEMORY CARD EXTENDER (P/O ASI-2752-159)	ASI DEALER
ASI-9509-001		629-9509-001	CABLE: BACK PLATE ASSY EXTENDER (P/O ASI-2752-159)	ASI DEALER
ASI-9539-001		634-9539-001	CABLE: MEMORY (P/O ASI-2390-001/002)	ASI DEALER
ASI-9540-001		634-9540-001	CABLE: CONTROL (P/O ASI-2390-001/002)	ASI DEALER
ASI-9541-001		634-9541-001	CABLE: PA (P/O ASI-2390-001/002)	ASI DEALER
ASI-9542-001		634-9542-001	CABLE: ALC NO 1 (P/O ASI-2390-001/002)	ASI DEALER
ASI-9543-001		634-9543-001	CABLE: ALC NO 2 (P/O ASI-2390-001/002)	ASI DEALER
ASI-9555-001		629-9555-001	CABLE: EXTENDER (P/O ASI-2752-159)	ASI DEALER
ASI-9556-001		629-9556-001	CABLE: EXTENDER (P/O ASI-2752-159)	ASI DEALER
ASI-9557-DLM		659-8732-001	DLM-700() POWER SUPPLY A6 TEST FIXTURE	ASI DEALER
ASI-9759-001		634-9759-001	EXTENDER CARD: ARC-186 SMO (PART OF ASI-2390-00X / 638-2390-00X KIT)	ASI DEALER
ASI-9871-001		629-9871-001	DISPLAY FILTER FOR COLLINS 478A-3 ZIFOR III	COLLINS
ASI-9581-001		629-9581-001	CABLE: EXTENDER (P/O ASI-2752-159)	ASI DEALER
ASI-9945-001		634-9945-001	EXTENDER CARD FOR HSI-85 A5 (P/O ASI-9999-001 EXTENDER KIT)	ASI DEALER
ASI-9977-001		634-9977-001	EXTENDER CARD FOR ADI-85 (P/O ASI-9999-001 EXTENDER KIT)	ASI DEALER
ASI-9999-001		634-9999-001	ADI-85() AND HSI-85() CARD EXTENDER KIT (INCLUDES 4 EXTENDER CARDS)	ASI DEALER
ASI-AA3710-1	AA3710-1		OVERALL TEST RIG FOR AD370 SYSTEM (OBSOLETE / REPLACED BY ASI-AA3710-2)	ASI DEALER
ASI-AA3710-2	AA3710-2		OVERALL TEST RIG FOR AD370 SYSTEM (INCLUDES 5 CABLES)	ASI DEALER
ASI-ACS-5A	ACS-5A	253E0414-00	AIRCRAFT SIMULATOR SYSTEM (MUST BE PURCHASED FROM GLENDALE INT'L)	GLENDALE
ASI-ADIRU-RT			ADIRU REMOVAL TOOL	ASI DEALER
ASI-AVR-02	AVR-02	100-2120-200	COCKPIT VOICE RECORDER TEST PANEL (INCLUDES 2 CABLES)	ASI DEALER
ASI-A24004-2	A24004-2		TEST RELAY: ISOLATION REQUEST POWER DIST SYSTEM	ASI DEALER
ASI-A31-6621-02	A31-6621-02		CABLE: ASI-AA3710-02 TO DISTRESS CONTROLLER	ASI DEALER
ASI-A32074-1	A32074-1		BREAKOUT BOX; RELAY SYSTEM AIR/GND	ASI DEALER
ASI-A3286382	A3286382		CABLE: W259 INC TO AN/VSQ-2B#1 TO CISCO 2924MXL	ASI DEALER
ASI-BD83-101	BD83-101		HYDRAULIC PUMP TEST ADAPTER SET	ASI DEALER
ASI-B2701-51	B2701-51		TEST BOX: ELEVATOR HARDOVER TEST	ASI DEALER
ASI-CTA-EXT			EXTENDER CABLE FOR COLLINS CTA CABLES	COLLINS
ASI-CTA-MB1			CABLE ADAPTER	COLLINS
ASI-CTA-MB2			VHF-4000 ESS CABLE ADAPTER	COLLINS
ASI-CTA-MB3			NAV-4000 ESS CABLE ADAPTER	COLLINS
ASI-CTA-MB4			RIU-4000 ESS CABLE ADAPTER	COLLINS
ASI-CTA-MB5			VDL-2000 ESS CABLE ADAPTER	COLLINS
ASI-CTA-1	CTA-1	827-2832-001	WXP-85 TEST ADAPTER CABLE	COLLINS
ASI-CTA-12	CTA-12	822-0360-001	EFIS TEST ADAPTER	ASI DEALER
ASI-CTA-14A	CTA-14A	822-0361-001	DPU-85/86 TEST ADAPTER	COLLINS
ASI-CTA-14B	CTA-14B	822-0362-001	DPU-84 TEST ADAPTER	COLLINS
ASI-CTA-14D	CTA-14D	822-0363-001	DPU-85/86 TEST ADAPTER	COLLINS
ASI-CTA-15A	CTA-15A	822-0366-001	MPU-85/86 TEST ADAPTER	COLLINS
ASI-CTA-15B	CTA-15B	822-0367-001	MPU-84 TEST ADAPTER	COLLINS
ASI-CTA-15D	CTA-15D	822-0368-001	MPU-85/86 TEST ADAPTER	COLLINS
ASI-CTA-2001	CTA-2001	822-0140-001	TEST ADAPTER	COLLINS
ASI-CTA-2007	CTA-2007	822-0146-001	ADC-85/86 TEST ADAPTER	COLLINS
ASI-CTA-2009	CTA-2009	822-0149-001	ADC-850 TEST ADAPTER	COLLINS
ASI-CTA-2011	CTA-2011	822-0212-001	TEST ADAPTER	COLLINS
ASI-CTA-2015	CTA-2015	822-0217-001	TEST ADAPTER	COLLINS
ASI-CTA-2017	CTA-2017	822-0238-002	TEST ADAPTER	COLLINS
ASI-CTA-2018	CTA-2018	822-0279-001	TEST ADAPTER	COLLINS
ASI-CTA-2019	CTA-2019	822-0285-001	RTU TEST ADAPTER	COLLINS
ASI-CTA-2024	CTA-2024	822-0404-001	TEST ADAPTER FOR DCP-4000 (ASI-404)	COLLINS
ASI-CTA-2031	CTA-2031	822-0459-001	TEST ADAPTER	COLLINS
ASI-CTA-2033	CTA-2033	822-0576-001	CDU TEST ADAPTER	COLLINS
ASI-CTA-2034	CTA-2034	822-0577-002	TEST ADAPTER	COLLINS
ASI-CTA-2035	CTA-2035	822-0578-001	TEST ADAPTER	COLLINS
ASI-CTA-2037	CTA-2037	822-0697-001	TEST ADAPTER	COLLINS
ASI-CTA-2037	CTA-2037	822-0697-003	TEST ADAPTER	COLLINS
ASI-CTA-2050	CTA-2050	822-1091-001	TEST ADAPTER (827-7972-001)	COLLINS
ASI-CTA-2053	CTA-2053	822-1205-001	DCP-3000 TEST ADAPTER	COLLINS
ASI-CTA-2054	CTA-2054	827-2480-001	LVPS TEST SET	COLLINS
ASI-CTA-2056	CTA-2056	822-1288-001	ADC-3000 TEST ADAPTER	COLLINS
ASI-CTA-2057	CTA-2057	822-1292-001	TEST ADAPTER	COLLINS
ASI-CTA-2063	CTA-2063	822-1563-001	TEST ADAPTER	COLLINS
ASI-CTC-429	CTC-429	822-0854-001	PRO LINE TEST CARD (TEST SOFTWARE MUST BE PURCHASED FROM COLLINS)	ASI DEALER
ASI-CTS-9	CTS-9	622-6720-001	EXTENDER CABLE BREAKOUT BOX	ASI DEALER

AVAILABILITY:

ASI DEALER: CONTACT ANY ASI DEALER FOR QUOTE
 COLLINS: CONTACT ROCKWELL COLLINS FOR QUOTE
 GABLES: CONTACT GABLES ENGINEERING FOR QUOTE
 TELEPHONICS: CONTACT TELEPHONICS FOR QUOTE

ASI SPECIALIZED TEST EQUIPMENT LIST

AVAILABILITY SUBJECT TO CHANGE WITHOUT NOTICE

<u>ASI MN</u>	<u>EQUIV MN</u>	<u>EQUIV PN</u>	<u>DESCRIPTION</u>	<u>AVAILABILITY</u>
ASI-CTS-10	CTS-10	622-4561-001	UNIVERSAL ATR BREAKOUT BOX	ASI DEALER
ASI-CTS-11	CTS-11	622-5380-001	COLLINS ADI-85 INSTRUMENT TEST SET	ASI DEALER
ASI-CTS-11A	CTS-11A	622-6823-001	COLLINS ADI-77 INSTRUMENT TEST SET	ASI DEALER
ASI-CTS-12	CTS-12	622-5381-001	COLLINS HSI-85 INSTRUMENT TEST SET	ASI DEALER
ASI-CTS-12A1		601-2123-001	LABEL CHANGER CARD	ASI DEALER
ASI-CTS-700-1			THIS ITEM HAS BEEN RENAMED ASI-700-1 (SEE ASI-700-1 FOR PRICE)	ASI DEALER
ASI-CTS-840	CTS-840	822-0080-001	RTA-84X/85X RADAR ABSORPTION BARREL	ASI DEALER
ASI-CTS-841	CTS-841	822-0081-001	RTA-84X/85X RECEIVER/TRANSMITTER/ANTENNA TEST PANEL	ASI DEALER
ASI-CTS-851	CTS-851	622-4708-001	APS-841H HELICOPTER AUTOPILOT TEST SET	ASI DEALER
ASI-CTS-859	CTS-859	622-7975-004	DIGITAL EFIS TEST PANEL	ASI DEALER
ASI-CTS-940	CTS-940	628-8750-001	TDR-94/94D MODE S TRANSPONDER TEST PANEL	ASI DEALER
ASI-CTS-941			TDR-94/94D MODE S TRANSPONDER TEST SET	ASI DEALER
ASI-CTS-941AR			TDR-94/94D MODE S TRANSPONDER TEST SET (BENCH RACK VERSION)	ASI DEALER
ASI-CTS-942			TDR-94 BURN-IN RELAY TEST PANEL	COLLINS
ASI-CTS-943			TDR-94D INTERFACE PANEL	COLLINS
ASI-CTS-944			RTA BURN-IN RF RELAY PANEL	COLLINS
ASI-CTS-945			RTA BURN-IN TEST PANEL	COLLINS
ASI-CTS-946			GLU BURN-IN PANEL	COLLINS
ASI-CTS-946-1			GLU BURN-IN PANEL	COLLINS
ASI-CTS-947		685-6824-001	A7 IF/LVPS TEST PANEL (INCL 3 CABLES)	ASI DEALER
ASI-CTS-948			A4/SMO TEST FIXTURE	COLLINS
ASI-CTS-949			AHC-3000 VXI INTERFACE PANEL	COLLINS
ASI-CTS-950			AHC-3000 POWER SUPPLY (A3) TEST FIXTURE	COLLINS
ASI-CTS-951			AHC-3000 IMU SIM CARD TEST FIXTURE	COLLINS
ASI-CTS-952			AHC-3000 CARCO VXI INTERFACE PANEL	COLLINS
ASI-CTS-953A			VHF-21/22/422 ESS TEST PANEL A	COLLINS
ASI-CTS-953B			VHF-21/22/422 ESS TEST PANEL B	COLLINS
ASI-CTS-954			TDR-94() XMIT TEST PANEL	COLLINS
ASI-CTS-955			RTA-8XX MODULATOR TESTER	ASI DEALER
ASI-CTS-956			RTA -8XX TRANSMITTER TEST PANEL	ASI DEALER
ASI-CTS-957			RTA-8XX RECEIVER/EXCITER TEST PANEL	ASI DEALER
ASI-CTS-958			CTS-88 AUX TEST PANEL (PRICE INCLUDES 801-F30 API)	COLLINS
ASI-CTS-959			AHC-3000 BURN-IN PANEL (12)	COLLINS
ASI-CTS-960		638-0274-001	AHC-85 SYNCHRO SELECT PANEL	COLLINS
ASI-CTS-961		638-0161-002	LOW CURRENT POWER CONTROL PANEL	COLLINS
ASI-CTS-962			36 INCH RATE TABLE VXI INTERFACE PANEL	COLLINS
ASI-CTS-963			ALT RF RELAY PANEL	COLLINS
ASI-CTS-964		685-6461-ASI	JC CONTROL PANEL	ASI DEALER
ASI-CTS-965			RTA RF TEST PANEL	COLLINS
ASI-CTS-966			INTERFACE PANEL	COLLINS
ASI-CTS-967			AHC-3000 BURN-IN PANEL W/4 CABLES	COLLINS
ASI-CTS-968			RIU-4000 ESS POWER PANEL	COLLINS
ASI-CTS-969			CTS-88 FDU SELECT FIXTURE W/4 CABLES	COLLINS
ASI-CTS-970			RTA-8XX ATE INTERFACE PANEL W/4 CABLES	COLLINS
ASI-CTS-971			RTA-8XX IMPATT TEST PANEL	COLLINS
ASI-CTS-972			RTA-8XX ESS TEST PANEL	COLLINS
ASI-CTS-973		638-1440-001	VHF-2100/4000 HASS PANEL	COLLINS
ASI-CTS-974		638-1381-001	FC BURN-IN PANEL	COLLINS
ASI-CTS-975		638-1461-001	POWER CONTROL INTERFACE PANEL	COLLINS
ASI-CTS-976		932500-101	LOCAL PANEL	COLLINS
ASI-CTS-977			RTA-4XXX TUA TEST BOX	COLLINS
ASI-CTS-978			RTA-4XXX MASS TRANSFER INTERFACE PANEL	COLLINS
ASI-CTS-979			RIU-4000 ESS ATE PANEL	COLLINS
ASI-CTS-980			PA TEST PANEL (INCLUDES ASI-CTS-980-1 AND ASI-CTS-980-2)	COLLINS
ASI-CTS-981			ACP-6000 ESS ATE PANEL	COLLINS
ASI-CTS-982			ACP-6000 ATE PANEL	COLLINS
ASI-CTS-983			ACP-6000 POWER SUPPLY PANEL (COLLINS SUPPLIES 828-2468-001/828-2407-001)	COLLINS
ASI-CTS-984			TX TEMPERATURE ALIGNMENT ELECTRICAL FIXTURE	COLLINS
ASI-CTS-984-1			MODULE ALIGNMENT FIXTURE	COLLINS
ASI-CTS-986			10 dB ATTENUATOR PANEL	COLLINS
ASI-DLC-800			MAINTENANCE KIT FOR COLLINS DLC-800()	ASI DEALER
ASI-DLM-700			MAINTENANCE KIT FOR COLLINS DLM-700()	ASI DEALER
ASI-DL100-35			DELAY LINE, 35FT / 71nS	ASI DEALER
ASI-DL100-100			DELAY LINE, 100FT / 203nS	ASI DEALER
ASI-DL100-250			DELAY LINE, 250FT / 508nS	ASI DEALER
ASI-DL100-500			DELAY LINE, 500FT / 1.015uS	ASI DEALER
ASI-ES120665-43		ES120665-43	C130 SENSOR	ASI DEALER
ASI-ES120666-9		ES120666-9	C130 FUEL FLOW CABLE	ASI DEALER
ASI-ES120666-13		ES120666-13	C130 TORQUE METER CABLE	ASI DEALER

AVAILABILITY:

ASI DEALER: CONTACT ANY ASI DEALER FOR QUOTE
 COLLINS: CONTACT ROCKWELL COLLINS FOR QUOTE
 GABLES: CONTACT GABLES ENGINEERING FOR QUOTE
 TELEPHONICS: CONTACT TELEPHONICS FOR QUOTE

ASI SPECIALIZED TEST EQUIPMENT LIST

AVAILABILITY SUBJECT TO CHANGE WITHOUT NOTICE

<u>ASI MN</u>	<u>EQUIV MN</u>	<u>EQUIV PN</u>	<u>DESCRIPTION</u>	<u>AVAILABILITY</u>
ASI-ES120666-65		ES120666-65	C130 TACHOMETER CABLE	ASI DEALER
ASI-ES120683-15		ES1202683-15	C130 CARD EXTENDER	ASI DEALER
ASI-FDX-A22001-22		FDX-A22001-22	REMOTE MCDP	ASI DEALER
ASI-G215-290005	G215-290005	G215-290005-83	TEST BOX WITH 5 CABLES	ASI DEALER
ASI-HS1-23055	HS1-23055	GSE3220281	NOSE WHEEL STEERING TEST BOX WITH 2 ADAPTER CABLES	ASI DEALER
ASI-HS2-2289	HS2-2289	GSE3220913	NWS TEST BOX ADAPTER CABLE (INCLUDED WITH ASI-HS1-23055)	ASI DEALER
ASI-HS3-2289	HS3-2289	GSE3220914	NWS TEST BOX ADAPTER CABLE (INCLUDED WITH ASI-HS1-23055)	ASI DEALER
ASI-KLM3E-86872		KLM3E-86872	EMERGENCY BATTERY PACK LOADER	ASI DEALER
ASI-LT6013A	ASI-IH-56		CABLE, ASI-200-8 (LT-5) to 618M-3/4/5	ASI DEALER
ASI-M1090			TEST SET FOR BAKER M1090	ASI DEALER
ASI-PLCS-01			RACK MOUNT COMPUTER SYSTEM WITH CTC-429 TEST CARD INSTALLED	ASI DEALER
ASI-PRO-360		PRO-360	DIGITAL PROTRACTOR / LEVEL (ACCURACY +/-0.1 DEGREES)	ASI DEALER
ASI-PRO-3600		PRO-3600	DIGITAL PROTRACTOR / LEVEL WITH RS-232 OUTPUT (ACCURACY +/-0.05 DEGREES)	ASI DEALER
ASI-PRO-3600-CBL		PRO-3600 CABLE	RS-232 CABLE AND FOOT SWITCH FOR ASI-PRO3600 (PRO3600)	ASI DEALER
ASI-RDX-01		638-0066-001	TURBULENCE MOD FIXTURE FOR RDX-7708()	ASI DEALER
ASI-RX1-LM	RX1-LM		TEST ADAPTER FOR GTF-1, GTF-2, GTL-6, GTF-10	ASI DEALER
ASI-SDD-EXT			SDD-640 PWR SUPPLY EXT	ASI DEALER
ASI-SDU-EXT			SDU-640 EXT CABLES (SET OF 3)	ASI DEALER
ASI-SDU-906		856-8022-010	SDU-906 TEST EQUIPMENT KIT	ASI DEALER
ASI-T450-100-TB1		T450-100-TB1	SWITCH TEST BOX FOR LANDING GEAR (450-100) AND FIRE CONTROL (450-300)	ASI DEALER
ASI-T450-100-TS		T450-100-TS	TEST STAND (INCLUDED WITH ASI-T450-100-TB1)	ASI DEALER
ASI-W-16			CABLE: CA-154-1 BATTERY TO BATTERY CHARGER	ASI DEALER
ASI-WS2			CABLE: RCA WEATHERSCOUT BENCH TEST HARNESS	ASI DEALER
ASI-Y-1		634-9848-001	CABLE: CTS-202 Y-ADAPTER TO CTL-220 AND TCR-220	ASI DEALER
ASI-Y-2		653-2159-001	CABLE: Y-ADAPTER (ASI-Y-1) TO CTL-230	ASI DEALER
ASI-Y-3			CABLE: Y-ADAPTER 339F-12 TO ATC-1400A OR SQUAWK NAUT I/II	ASI DEALER

AVAILABILITY:

ASI DEALER: CONTACT ANY ASI DEALER FOR QUOTE
 COLLINS: CONTACT ROCKWELL COLLINS FOR QUOTE
 GABLES: CONTACT GABLES ENGINEERING FOR QUOTE
 TELEPHONICS: CONTACT TELEPHONICS FOR QUOTE